

Rack and Panel Connectors Side Mount



WA20



A20

APPLICATIONS

Broad-limited only by those applications requiring physical, electrical and/or materials specifications exceeding those indicated.

ELECTRICAL SPECIFICATIONS

Current Rating: 7.5 A

Breakdown Voltage (Contact to Contact):

At sea level: 2000 V_{RMS}

At 70 000 feet [21 336 meters]: 500 V_{RMS}

FEATURES

- Body components available with any desired pin and socket combination
- Floating contacts
- Polarization accomplished by reversed pin and socket combination
- Model A20 has barriers for increased creepage distance
- Thru hole permits use of building block technique or flat mounting

MATERIAL SPECIFICATIONS

Standard Body: Glass-filled diallyl phthalate per ASTM D 5948-96 green, flame retardant

Pin Contacts: Brass

Socket Contacts: Phosphor bronze

Contact Plating: Gold, 10 micro-inches

PHYSICAL SPECIFICATIONS

Minimum Creepage Path between Contacts:

A20 = 0.08" [2.03 mm]; WA20 = 0.05" [1.27 mm]

Minimum Air Space between Contacts:

A20 = 0.08" [2.03 mm]; WA20 = 0.05" [1.27 mm]

Contact, Center to Center: A20 = 0.150" [3.18 mm];

WA20 = 0.125" [3.17 mm]

DIMENSIONS in inches [millimeters]

A20P-CD

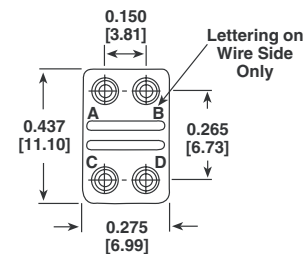
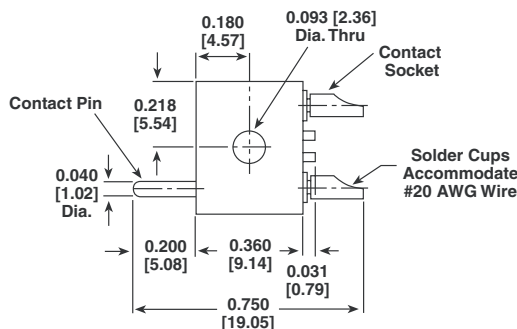

A20S-CD

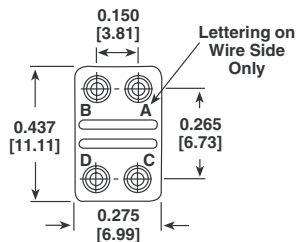
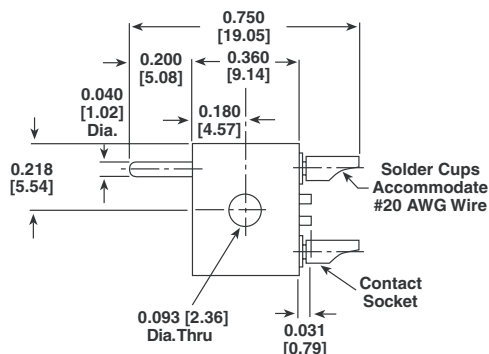

DIMENSIONS in inches [millimeters]

WA20P-CD

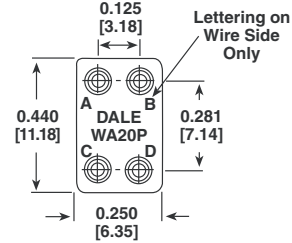
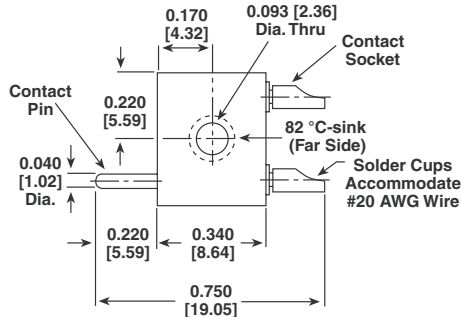

WA20S-CD



ORDERING INFORMATION

A20
WA20
MODEL

Side Mount with 4 positions
for #20 AWG contacts

P
BODY STYLE

P - Designates pin style body.
S - Designates socket style body.
These designations are used to identify mating connectors, however, any combination of pin and socket contacts may be ordered in either style body. Therefore, when designators 3 and 4 are the same, a connector designated A20P or WA20P will mate with a connector designated A20S or WA20S.
Example:
A20P-CD mates with A20S-CD
A20S-AB mates with A20P-CD

AB
CONTACT LOCATION

Designates pin contact positions in an A20P or WA20P connector or socket contact positions in an A20S or WA20S connector (specify "A", "B", "C", "D" or any combination of the four)

A
EMPTY CONTACT POSITIONS

Specify by contact identification letter (A, B, etc.) any contact positions which are to be left empty (omit, if none required)

EXAMPLE 1:

A20P-CD or WA20P-CD = Connector with pin contacts in positions "C" and "D" and socket contacts in positions "A" and "B"

EXAMPLE 2:

A20S-CD or WA20S-CD = Connector with socket contacts in positions "C" and "D" and pin contacts in positions "A" and "B" (would mate with Example 1 at left)

EXAMPLE 3:

A20P-BC or WA20P-BC-A = Connector with pin contacts in positions "B" and "C", socket contact in position "D" and no contact in position "A" (would mate with A20S-BC or WA20S-BC-A)



Disclaimer

ALL PRODUCT, PRODUCT SPECIFICATIONS AND DATA ARE SUBJECT TO CHANGE WITHOUT NOTICE TO IMPROVE RELIABILITY, FUNCTION OR DESIGN OR OTHERWISE.

Vishay Intertechnology, Inc., its affiliates, agents, and employees, and all persons acting on its or their behalf (collectively, "Vishay"), disclaim any and all liability for any errors, inaccuracies or incompleteness contained in any datasheet or in any other disclosure relating to any product.

Vishay makes no warranty, representation or guarantee regarding the suitability of the products for any particular purpose or the continuing production of any product. To the maximum extent permitted by applicable law, Vishay disclaims (i) any and all liability arising out of the application or use of any product, (ii) any and all liability, including without limitation special, consequential or incidental damages, and (iii) any and all implied warranties, including warranties of fitness for particular purpose, non-infringement and merchantability.

Statements regarding the suitability of products for certain types of applications are based on Vishay's knowledge of typical requirements that are often placed on Vishay products in generic applications. Such statements are not binding statements about the suitability of products for a particular application. It is the customer's responsibility to validate that a particular product with the properties described in the product specification is suitable for use in a particular application. Parameters provided in datasheets and/or specifications may vary in different applications and performance may vary over time. All operating parameters, including typical parameters, must be validated for each customer application by the customer's technical experts. Product specifications do not expand or otherwise modify Vishay's terms and conditions of purchase, including but not limited to the warranty expressed therein.

Except as expressly indicated in writing, Vishay products are not designed for use in medical, life-saving, or life-sustaining applications or for any other application in which the failure of the Vishay product could result in personal injury or death. Customers using or selling Vishay products not expressly indicated for use in such applications do so at their own risk. Please contact authorized Vishay personnel to obtain written terms and conditions regarding products designed for such applications.

No license, express or implied, by estoppel or otherwise, to any intellectual property rights is granted by this document or by any conduct of Vishay. Product names and markings noted herein may be trademarks of their respective owners.

Material Category Policy

Vishay Intertechnology, Inc. hereby certifies that all its products that are identified as RoHS-Compliant fulfill the definitions and restrictions defined under Directive 2011/65/EU of The European Parliament and of the Council of June 8, 2011 on the restriction of the use of certain hazardous substances in electrical and electronic equipment (EEE) - recast, unless otherwise specified as non-compliant.

Please note that some Vishay documentation may still make reference to RoHS Directive 2002/95/EC. We confirm that all the products identified as being compliant to Directive 2002/95/EC conform to Directive 2011/65/EU.

Vishay Intertechnology, Inc. hereby certifies that all its products that are identified as Halogen-Free follow Halogen-Free requirements as per JEDEC JS709A standards. Please note that some Vishay documentation may still make reference to the IEC 61249-2-21 definition. We confirm that all the products identified as being compliant to IEC 61249-2-21 conform to JEDEC JS709A standards.

Данный компонент на территории Российской Федерации

Вы можете приобрести в компании MosChip.

Для оперативного оформления запроса Вам необходимо перейти по данной ссылке:

<http://moschip.ru/get-element>

Вы можете разместить у нас заказ для любого Вашего проекта, будь то серийное производство или разработка единичного прибора.

В нашем ассортименте представлены ведущие мировые производители активных и пассивных электронных компонентов.

Нашей специализацией является поставка электронной компонентной базы двойного назначения, продукции таких производителей как XILINX, Intel (ex.ALTERA), Vicor, Microchip, Texas Instruments, Analog Devices, Mini-Circuits, Amphenol, Glenair.

Сотрудничество с глобальными дистрибьюторами электронных компонентов, предоставляет возможность заказывать и получать с международных складов практически любой перечень компонентов в оптимальные для Вас сроки.

На всех этапах разработки и производства наши партнеры могут получить квалифицированную поддержку опытных инженеров.

Система менеджмента качества компании отвечает требованиям в соответствии с ГОСТ Р ИСО 9001, ГОСТ РВ 0015-002 и ЭС РД 009

Офис по работе с юридическими лицами:

105318, г.Москва, ул.Щербаковская д.3, офис 1107, 1118, ДЦ «Щербаковский»

Телефон: +7 495 668-12-70 (многоканальный)

Факс: +7 495 668-12-70 (доб.304)

E-mail: info@moschip.ru

Skype отдела продаж:

moschip.ru

moschip.ru_4

moschip.ru_6

moschip.ru_9