

# NCL30082

## Dimmable Quasi-Resonant Primary Side Current-Mode Controller for LED Lighting with Thermal Fold-back

The NCL30082 is a PWM current mode controller targeting isolated flyback and non-isolated constant current topologies. The controller operates in a quasi-resonant mode to provide high efficiency. Thanks to a novel control method, the device is able to precisely regulate a constant LED current from the primary side. This removes the need for secondary side feedback circuitry, biasing and an optocoupler.

The device is highly integrated with a minimum number of external components. A robust suite of safety protection is built in to simplify the design. This device supports analog/digital dimming as well as thermal current fold-back. While the NCL30082 has integrated fixed overvoltage protection, the designer has the flexibility to program a lower OVP level.

### Features

- Quasi-resonant Peak Current-mode Control Operation
- Primary Side Sensing (no optocoupler needed)
- Wide  $V_{CC}$  Range
- Source 300 mA / Sink 500 mA Totem Pole Driver with 12 V Gate Clamp
- Precise LED Constant Current Regulation  $\pm 1\%$  Typical
- Line Feed-forward for Enhanced Regulation Accuracy
- Low LED Current Ripple
- 250 mV  $\pm 2\%$  Guaranteed Voltage Reference for Current Regulation
- $\sim 0.9$  Power Factor with Valley Fill Input Stage
- Low Start-up Current (13  $\mu$ A typ.)
- Analog or Digital Dimming
- Thermal Fold-back
- Wide Temperature Range of  $-40$  to  $+125^{\circ}\text{C}$
- Pb-Free, Halide-Free MSL1 Product
- Robust Protection Features
  - ◆ Over Voltage / LED Open Circuit Protection
  - ◆ Over Temperature Protection
  - ◆ Secondary Diode Short Protection
  - ◆ Output Short Circuit Protection
  - ◆ Shorted Current Sense Pin Fault Detection
  - ◆ Latched and Auto-recoverable Versions
  - ◆ Brown-out
  - ◆  $V_{CC}$  Under Voltage Lockout
  - ◆ Thermal Shutdown
- These Devices are Pb-Free and Halogen Free/BFR Free

### Typical Applications

- Integral LED Bulbs
- LED Power Driver Supplies
- LED Light Engines



ON Semiconductor®

[www.onsemi.com](http://www.onsemi.com)



Micro8  
DM SUFFIX  
CASE 846A

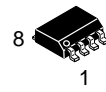

SOIC-8  
D SUFFIX  
CASE 751

### MARKING DIAGRAMS

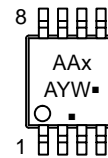

AAx = Specific Device Code  
x = C, D or H  
A = Assembly Location  
Y = Year  
W = Work Week  
■ = Pb-Free Package  
(Note: Microdot may be in either location)

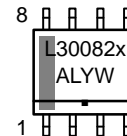

L30082x = Specific Device Code  
x = B, B1, B2, B3, D  
A = Assembly Location  
L = Wafer Lot  
Y = Year  
W = Work Week  
■ = Pb-Free Package

### PIN CONNECTIONS

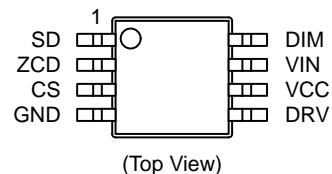

### ORDERING INFORMATION

See detailed ordering and shipping information on page 33 of this data sheet.

# NCL30082

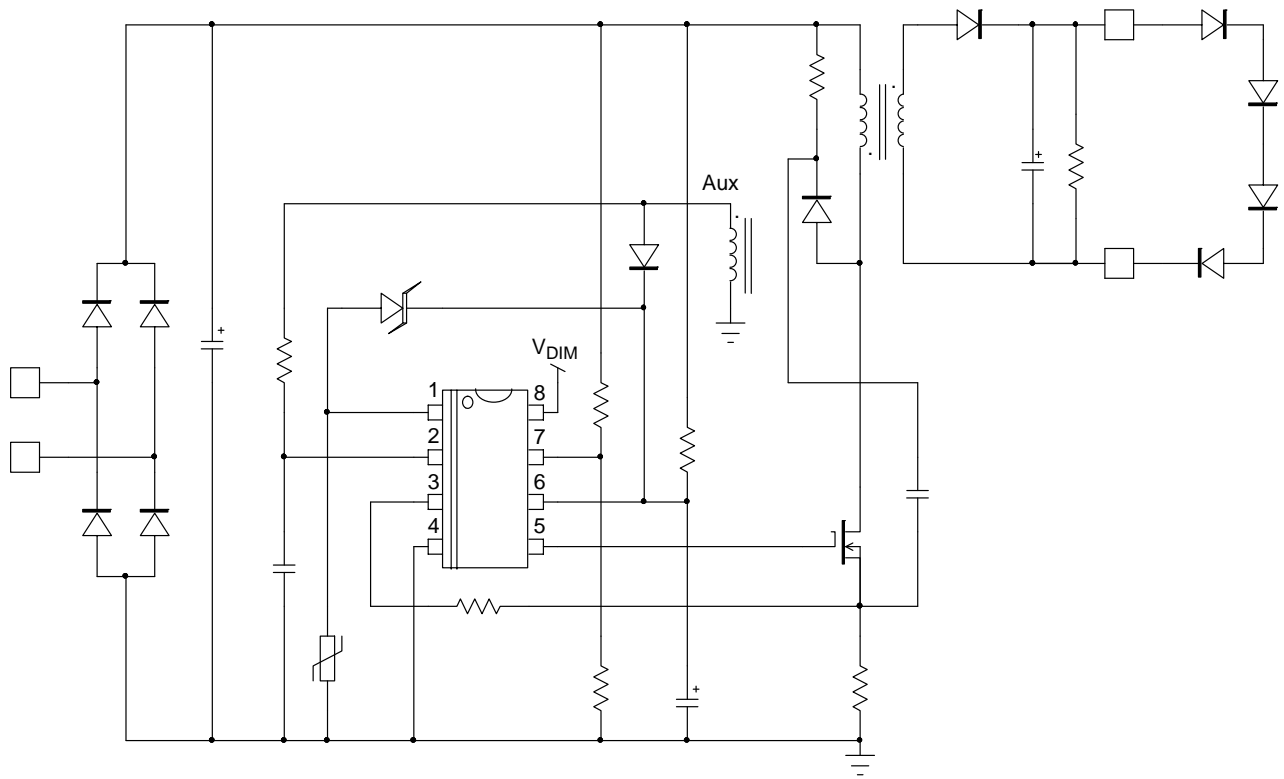

Figure 1. Typical Application Schematic for NCL30082

Table 1. PIN FUNCTION DESCRIPTION

Pin No	Pin Name	Function	Pin Description
1	SD	Thermal Fold-back and shutdown	Connecting an NTC to this pin allows reducing the output current down to 50% of its fixed value before stopping the controller. A Zener diode can also be used to pull-up the pin and stop the controller for adjustable OVP protection
2	ZCD	Zero Crossing Detection	Connected to the auxiliary winding, this pin detects the core reset event.
3	CS	Current sense	This pin monitors the primary peak current
4	GND	-	The controller ground
5	DRV	Driver output	The current capability of the totem pole gate drive (+0.3/-0.5 A) makes it suitable to effectively drive a broad range of power MOSFETs.
6	VCC	Supplies the controller	This pin is connected to an external auxiliary voltage.
7	VIN	Input voltage sensing Brown-Out	This pin observes the HV rail and is used in valley selection. This pin also monitors and protects for low mains conditions.
8	DIM	Analog / PWM dimming	This pin is used for analog or PWM dimming control. An analog signal than can be varied between $V_{DIM(EN)}$ and $V_{DIM100}$ can be used to vary the current, or a PWM signal with an amplitude greater than $V_{DIM100}$ .

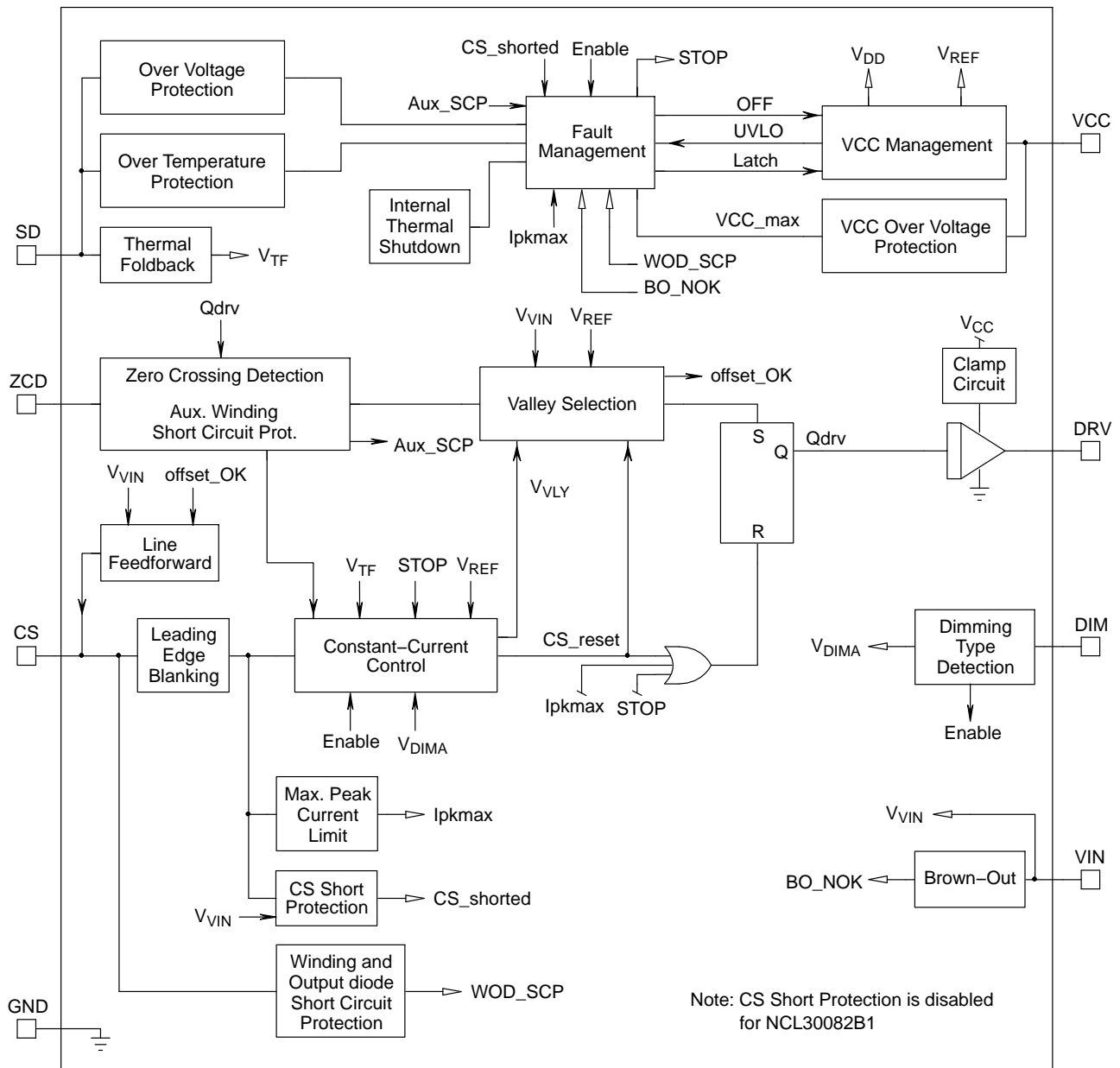

Figure 2. Internal Circuit Architecture

**Table 2. MAXIMUM RATINGS TABLE**

Symbol	Rating	Value	Unit
$V_{CC(MAX)}$ $I_{CC(MAX)}$	Maximum Power Supply voltage, VCC pin, continuous voltage Maximum current for VCC pin	-0.3, +35 Internally limited	V mA
$V_{DRV(MAX)}$ $I_{DRV(MAX)}$	Maximum driver pin voltage, DRV pin, continuous voltage Maximum current for DRV pin	-0.3, $V_{DRV}$ (Note 1) -500, +800	V mA
$V_{MAX}$ $I_{MAX}$	Maximum voltage on low power pins (except pins ZCD, DIM, DRV and VCC) Current range for low power pins (except pins ZCD, DRV and VCC)	-0.3, +5.5 -2, +5	V mA
$V_{ZCD(MAX)}$ $I_{ZCD(MAX)}$	Maximum voltage for ZCD pin Maximum current for ZCD pin	-0.3, +10 -2, +5	V mA
$V_{DIM(MAX)}$	Maximum voltage for DIM pin	-0.3, +10	V
$R_{\theta JA}$	Thermal Resistance, Junction-to-Ambient (Note 4) Micro8 version SOIC-8 version	228 180	°C/W
$\Psi_{JC}$	Thermal Characterization Parameter, Junction-to-Case Top Micro8 version SOIC-8 version	50 45	°C/W
$T_J(MAX)$	Maximum Junction Temperature	150	°C
	Operating Temperature Range	-40 to +125	°C
	Storage Temperature Range	-60 to +150	°C
	ESD Capability, HBM model (Note 2)	4	kV
	ESD Capability, MM model (Note 2)	200	V

Stresses exceeding those listed in the Maximum Ratings table may damage the device. If any of these limits are exceeded, device functionality should not be assumed, damage may occur and reliability may be affected.

- $V_{DRV}$  is the DRV clamp voltage  $V_{DRV(high)}$  when  $V_{CC}$  is higher than  $V_{DRV(high)}$ .  $V_{DRV}$  is  $V_{CC}$  unless otherwise noted.
- This device series contains ESD protection and exceeds the following tests: Human Body Model 4000 V per JEDEC JESD22-A114-F and Machine Model Method 200 V per JEDEC JESD22-A115-A.
- This device contains latch-up protection and exceeds 100 mA per JEDEC Standard JESD78 except for VIN pin which passes 60 mA.
- With a 100 mm<sup>2</sup>, 2 oz copper area based on JEDEC EIA/JESD51-3 board design.

**Table 3. ELECTRICAL CHARACTERISTICS** (Unless otherwise noted: For typical values  $T_J = 25^\circ\text{C}$ ,  $V_{CC} = 12\text{ V}$ ;  
For min/max values  $T_J = -40^\circ\text{C}$  to  $+125^\circ\text{C}$ , Max  $T_J = 150^\circ\text{C}$ ,  $V_{CC} = 12\text{ V}$ )

Description	Test Condition	Symbol	Min	Typ	Max	Unit
<b>STARTUP AND SUPPLY CIRCUITS</b>						
Supply Voltage						V
Startup Threshold	$V_{CC}$ increasing	$V_{CC(on)}$	16	18	20	
Minimum Operating Voltage	$V_{CC}$ decreasing	$V_{CC(off)}$	8.2	8.8	9.4	
Hysteresis $V_{CC(on)} - V_{CC(off)}$	$V_{CC}$ decreasing	$V_{CC(HYS)}$	8	-	-	
Internal logic reset		$V_{CC(reset)}$	3.5	4.5	5.5	
Over Voltage Protection		$V_{CC(OVP)}$	26	28	30	V
$V_{CC(off)}$ noise filter		$t_{VCC(off)}$	-	5	-	μs
$V_{CC(reset)}$ noise filter-		$t_{VCC(reset)}$	-	20	-	
Startup current		$I_{CC(start)}$	-	13	30	μA
Startup current in fault mode		$I_{CC(sFault)}$	-	46	60	μA
Supply Current						mA
Device Disabled/Fault	$V_{CC} > V_{CC(off)}$	$I_{CC1}$	0.8	1.2	1.4	
Device Enabled/No output load on pin 5	$F_{sw} = 65\text{ kHz}$	$I_{CC2}$	-	2.3	4.0	
Device Switching ( $F_{sw} = 65\text{ kHz}$ )	$C_{DRV} = 470\text{ pF}$ , $F_{sw} = 65\text{ kHz}$	$I_{CC3}$	-	2.7	5.0	

Product parametric performance is indicated in the Electrical Characteristics for the listed test conditions, unless otherwise noted. Product performance may not be indicated by the Electrical Characteristics if operated under different conditions.

- Guaranteed by design.

# NCL30082

**Table 3. ELECTRICAL CHARACTERISTICS** (Unless otherwise noted: For typical values  $T_J = 25^\circ\text{C}$ ,  $V_{CC} = 12\text{ V}$ ; For min/max values  $T_J = -40^\circ\text{C}$  to  $+125^\circ\text{C}$ , Max  $T_J = 150^\circ\text{C}$ ,  $V_{CC} = 12\text{ V}$ )

Description	Test Condition	Symbol	Min	Typ	Max	Unit
<b>CURRENT SENSE</b>						
Maximum Internal current limit		$V_{ILIM}$	0.95	1	1.05	V
Leading Edge Blanking Duration for $V_{ILIM}$ ( $T_J = -25^\circ\text{C}$ to $125^\circ\text{C}$ ) (Not applicable for NCL30082D)		$t_{LEB}$	250	300	350	ns
Leading Edge Blanking Duration for $V_{ILIM}$ ( $T_J = -40^\circ\text{C}$ to $125^\circ\text{C}$ )		$t_{LEB}$	240	300	350	ns
Input Bias Current	DRV high	$I_{bias}$	–	0.02	–	$\mu\text{A}$
Propagation delay from current detection to gate off–state		$t_{LIM}$	–	50	150	ns
Threshold for immediate fault protection activation		$V_{CS(stop)}$	1.35	1.5	1.65	V
Leading Edge Blanking Duration for $V_{CS(stop)}$		$t_{BCS}$	–	120	–	ns
Blanking time for CS to GND short detection $V_{pinVIN} = 1\text{ V}$		$t_{CS(blank1)}$	6	–	12	$\mu\text{s}$
Blanking time for CS to GND short detection $V_{pinVIN} = 1\text{ V}$ NCL30082D		$t_{CS(blank1)D}$	8	10.7	14	$\mu\text{s}$
Blanking time for CS to GND short detection $V_{pinVIN} = 3.3\text{ V}$		$t_{CS(blank2)}$	2	–	4	$\mu\text{s}$
Blanking time for CS to GND short detection $V_{pinVIN} = 3.3\text{ V}$ NCL30082D		$t_{CS(blank2)D}$	2.6	3.6	4.6	$\mu\text{s}$
<b>GATE DRIVE</b>						
Drive Resistance DRV Sink DRV Source		$R_{SNK}$ $R_{SRC}$	– –	13 30	– –	$\Omega$
Drive current capability DRV Sink (Note 6) DRV Source (Note 6)		$I_{SNK}$ $I_{SRC}$	– –	500 300	– –	mA
Rise Time (10% to 90%)	$C_{DRV} = 470\text{ pF}$	$t_r$	–	40	–	ns
Fall Time (90% to 10%)	$C_{DRV} = 470\text{ pF}$	$t_f$	–	30	–	ns
DRV Low Voltage	$V_{CC} = V_{CC(off)} + 0.2\text{ V}$ $C_{DRV} = 470\text{ pF}$ , $R_{DRV} = 33\text{ k}\Omega$	$V_{DRV(low)}$	8	–	–	V
DRV High Voltage	$V_{CC} = 30\text{ V}$ $C_{DRV} = 470\text{ pF}$ , $R_{DRV} = 33\text{ k}\Omega$	$V_{DRV(high)}$	10	12	14	V

Product parametric performance is indicated in the Electrical Characteristics for the listed test conditions, unless otherwise noted. Product performance may not be indicated by the Electrical Characteristics if operated under different conditions.

6. Guaranteed by design.

## NCL30082

**Table 3. ELECTRICAL CHARACTERISTICS** (Unless otherwise noted: For typical values  $T_J = 25^\circ\text{C}$ ,  $V_{CC} = 12\text{ V}$ ; For min/max values  $T_J = -40^\circ\text{C}$  to  $+125^\circ\text{C}$ , Max  $T_J = 150^\circ\text{C}$ ,  $V_{CC} = 12\text{ V}$ )

Description	Test Condition	Symbol	Min	Typ	Max	Unit
<b>ZERO VOLTAGE DETECTION CIRCUIT</b>						
ZCD threshold voltage	$V_{ZCD}$ increasing	$V_{ZCD(THI)}$	25	45	65	mV
ZCD threshold voltage (Note 6)	$V_{ZCD}$ decreasing	$V_{ZCD(THD)}$	5	25	45	mV
ZCD hysteresis (Note 6)	$V_{ZCD}$ increasing	$V_{ZCD(HYS)}$	10	–	–	mV
Threshold voltage for output short circuit or aux. winding short circuit detection		$V_{ZCD(short)}$	0.8	1	1.2	V
Short circuit detection Timer	$V_{ZCD} < V_{ZCD(short)}$	$t_{OVL D}$	70	90	110	ms
Auto-recovery timer duration		$t_{recovery}$	3	4	5	s
Input clamp voltage High state Low state	$I_{pin1} = 3.0\text{ mA}$ $I_{pin1} = -2.0\text{ mA}$	$V_{CH}$ $V_{CL}$	– –0.9	9.5 –0.6	– –0.3	V
Propagation Delay from valley detection to DRV high	$V_{ZCD}$ decreasing	$t_{DEM}$	–	–	150	ns
Equivalent time constant for ZCD input (Note 6)		$t_{PAR}$	–	20	–	ns
Blanking delay after on-time		$t_{BLANK}$	2.25	3	3.75	$\mu\text{s}$
Blanking delay after on-time NCL30082B2 and NCL30082B3		$t_{BLANKB2}$	1.2	1.6	2.0	$\mu\text{s}$
Timeout after last demag transition		$t_{TIMO}$	5	6.5	8	$\mu\text{s}$

### CONSTANT CURRENT CONTROL

Reference Voltage at $T_J = 25^\circ\text{C}$		$V_{REF}$	245	250	255	mV
Reference Voltage $T_J = -40^\circ\text{C}$ to $125^\circ\text{C}$		$V_{REF}$	242.5	250	257.5	mV
Reference Voltage NCL30082D ( $T_J = 25^\circ\text{C}$ )		$V_{REFD}$	495	500	505	mV
Reference Voltage NCL30082D ( $T_J = 0^\circ\text{C}$ to $85^\circ\text{C}$ )		$V_{REFD}$	492	500	508	mV
Reference Voltage NCL30082D ( $T_J = -40^\circ\text{C}$ to $125^\circ\text{C}$ )		$V_{REFD}$	488	500	512	mV
Reference Voltage NCL30082B3 ( $T_J = 25^\circ\text{C}$ )		$V_{REFB3}$	329	333	337	mV
Reference Voltage NCL30082B3 ( $T_J = 0^\circ\text{C}$ to $85^\circ\text{C}$ )		$V_{REFB3}$	325	333	341	mV
Reference Voltage NCL30082B3 ( $T_J = -40^\circ\text{C}$ to $125^\circ\text{C}$ )		$V_{REFB3}$	321	333	345	mV
50% reference voltage (for thermal foldback)		$V_{REF50}$	–	125	–	mV
25% reference voltage (for thermal foldback) NCL30082D		$V_{REF25D}$	–	125	–	mV
Current sense lower threshold for detection of the leakage inductance reset time		$V_{CS(low)}$	30	55	80	mV

### LINE FEED-FORWARD

$V_{VIN}$ to $I_{CS(offset)}$ conversion ratio		$K_{LFF}$	15	17	19	$\mu\text{A/V}$
Offset current maximum value	$V_{pinVIN} = 4.5\text{ V}$	$I_{offset(MAX)}$	67.5	76.5	85.5	$\mu\text{A}$
$V_{REF}$ value below which the offset current source is turned off	$V_{REF}$ decreases	$V_{REF(off)}$	–	37.5	–	mV
$V_{REF}$ value above which the offset current source is turned on	$V_{REF}$ increases	$V_{REF(on)}$	–	50	–	mV

### VALLEY SELECTION

Threshold for line range detection $V_{in}$ increasing (1 <sup>st</sup> to 2 <sup>nd</sup> valley transition for $V_{REF} > 0.75\text{ V}$ )	$V_{VIN}$ increases	$V_{HL}$	2.28	2.4	2.52	V
Threshold for line range detection $V_{in}$ decreasing (2 <sup>nd</sup> to 1 <sup>st</sup> valley transition for $V_{REF} > 0.75\text{ V}$ )	$V_{VIN}$ decreases	$V_{LL}$	2.18	2.3	2.42	V
Blanking time for line range detection		$t_{HL(blank)}$	15	25	35	ms

Product parametric performance is indicated in the Electrical Characteristics for the listed test conditions, unless otherwise noted. Product performance may not be indicated by the Electrical Characteristics if operated under different conditions.

6. Guaranteed by design.

## NCL30082

**Table 3. ELECTRICAL CHARACTERISTICS** (Unless otherwise noted: For typical values  $T_J = 25^\circ\text{C}$ ,  $V_{CC} = 12\text{ V}$ ; For min/max values  $T_J = -40^\circ\text{C}$  to  $+125^\circ\text{C}$ , Max  $T_J = 150^\circ\text{C}$ ,  $V_{CC} = 12\text{ V}$ )

Description	Test Condition	Symbol	Min	Typ	Max	Unit
<b>VALLEY SELECTION</b>						
Valley thresholds						mV
1 <sup>st</sup> to 2 <sup>nd</sup> valley transition at LL and 2 <sup>nd</sup> to 3 <sup>rd</sup> valley HL	$V_{REF}$ decreases	$V_{VLY1-2/2-3}$	177.5	187.5	197.5	
2 <sup>nd</sup> to 1 <sup>st</sup> valley transition at LL and 3 <sup>rd</sup> to 2 <sup>nd</sup> valley HL	$V_{REF}$ increases	$V_{VLY2-1/3-2}$	185.0	195.0	205.0	
2 <sup>nd</sup> to 4 <sup>th</sup> valley transition at LL and 3 <sup>rd</sup> to 5 <sup>th</sup> valley HL	$V_{REF}$ decreases	$V_{VLY2-4/3-5}$	117.5	125.0	132.5	
4 <sup>th</sup> to 2 <sup>nd</sup> valley transition at LL and 5 <sup>th</sup> to 3 <sup>rd</sup> valley HL	$V_{REF}$ increases	$V_{VLY4-2/5-3}$	125.0	132.5	140.0	
4 <sup>th</sup> to 7 <sup>th</sup> valley transition at LL and 5 <sup>th</sup> to 8 <sup>th</sup> valley HL	$V_{REF}$ decreases	$V_{VLY4-7/5-8}$	–	75.0	–	
7 <sup>th</sup> to 4 <sup>th</sup> valley transition at LL and 8 <sup>th</sup> to 5 <sup>th</sup> valley HL	$V_{REF}$ increases	$V_{VLY7-4/8-5}$	–	82.5	–	
7 <sup>th</sup> to 11 <sup>th</sup> valley transition at LL and 8 <sup>th</sup> to 12 <sup>th</sup> valley HL	$V_{REF}$ decreases	$V_{VLY7-11/8-12}$	–	37.5	–	
11 <sup>th</sup> to 7 <sup>th</sup> valley transition at LL and 12 <sup>th</sup> to 8 <sup>th</sup> valley HL	$V_{REF}$ increases	$V_{VLY11-7/12-8}$	–	50.0	–	
11 <sup>th</sup> to 13 <sup>th</sup> valley transition at LL and 12 <sup>th</sup> to 15 <sup>th</sup> valley HL	$V_{REF}$ decreases	$V_{VLY11-13/12-15}$	–	15.0	–	
13 <sup>th</sup> to 11 <sup>th</sup> valley transition at LL and 15 <sup>th</sup> to 12 <sup>th</sup> valley HL	$V_{REF}$ increases	$V_{VLY13-11/15-12}$	–	20.0	–	
<b>DIMMING SECTION</b>						
DIM pin voltage for zero output current (OFF voltage)		$V_{DIM(EN)}$	0.66	0.7	0.74	V
DIM pin voltage for maximum output current		$V_{DIM100}$	2.25	2.45	2.65	V
Dimming range		$V_{DIM(range)}$	–	1.75	–	V
Clamping voltage for DIM pin		$V_{DIM(CLP)}$	–	7.8	–	V
Dimming pin pull-up current source		$I_{DIM(pullup)}$	–	280	–	nA
<b>THERMAL FOLD-BACK AND OVP</b>						
Reference current for direct connection of an NTC (Note 6)		$I_{OTP(REF)}$	80	85	90	
SD pin voltage at which thermal fold-back starts		$V_{TF(start)}$	0.9	1	1.1	V
SD pin voltage at which thermal fold-back stops ( $I_{out} = 50\% I_{out(nom)}$ )		$V_{TF(stop)}$	0.64	0.68	0.72	V
SD pin voltage at which thermal fold-back stops NCL30082D ( $I_{out} = 25\% I_{out(nom)}$ )		$V_{TF(stop)D}$	0.86	0.90	0.94	V
Reference current for direct connection of an NTC		$I_{OTP(REF)}$	80	85	90	$\mu\text{A}$
Fault detection level for OTP	$V_{SD}$ decreasing	$V_{OTP(off)}$	0.47	0.5	0.53	V
Fault detection level for OTP NCL30082D		$V_{OTP(off)D}$	0.81	0.85	0.89	V
SD pin level at which controller re-start switching after OTP detection	$V_{SD}$ increasing	$V_{OTP(on)}$	0.64	0.68	0.72	V
SD pin level at which controller re-start switching after OTP detection NCL30082D		$V_{OTP(on)D}$	0.86	0.9	0.94	V
SD pin Over temperature Protection Hysteresis NCL30082D		$V_{OTP(hys)D}$	15	50	100	mV
$V_{TF(start)}$ over $I_{OTP(REF)}$ ratio (Note 5)	$T_J = +25^\circ\text{C}$ to $+125^\circ\text{C}$	$R_{TF(start)}$	10.8	11.7	12.6	$\text{k}\Omega$
$V_{TF(stop)}$ over $I_{OTP(REF)}$ ratio (Note 5)	$T_J = +25^\circ\text{C}$ to $+125^\circ\text{C}$	$R_{TF(stop)}$	7.4	8.0	8.6	$\text{k}\Omega$
$V_{OTP(off)}$ over $I_{OTP(REF)}$ ratio (Note 5)	$T_J = +25^\circ\text{C}$ to $+125^\circ\text{C}$	$R_{OTP(off)}$	5.4	5.9	6.4	$\text{k}\Omega$
$V_{OTP(on)}$ over $I_{OTP(REF)}$ ratio (Note 5)	$T_J = +25^\circ\text{C}$ to $+125^\circ\text{C}$	$R_{OTP(on)}$	7.4	8.0	8.6	$\text{k}\Omega$
$V_{TF(stop)}$ over $I_{OTP(REF)}$ ratio NCL30082D (Note 5)	$T_J = +25^\circ\text{C}$ to $+125^\circ\text{C}$	$R_{TF(stop)D}$	9.9	10.5	11.1	$\text{k}\Omega$
$V_{OTP(off)}$ over $I_{OTP(REF)}$ ratio NCL30082D (Note 5)	$T_J = +25^\circ\text{C}$ to $+125^\circ\text{C}$	$R_{OTP(off)D}$	9.4	10.0	10.6	$\text{k}\Omega$
$V_{OTP(on)}$ over $I_{OTP(REF)}$ ratio NCL30082D (Note 5)	$T_J = +25^\circ\text{C}$ to $+125^\circ\text{C}$	$R_{OTP(on)D}$	9.9	10.5	11.1	$\text{k}\Omega$

5. A NTC is generally placed between the SD and GND pins. Parameters  $R_{TF(start)}$ ,  $R_{TF(stop)}$ ,  $R_{OTP(off)}$  and  $R_{OTP(on)}$  give the resistance the NTC must exhibit to respectively, enter thermal foldback, stop thermal foldback, trigger the OTP limit and allow the circuit recovery after an OTP situation.

Product parametric performance is indicated in the Electrical Characteristics for the listed test conditions, unless otherwise noted. Product performance may not be indicated by the Electrical Characteristics if operated under different conditions.

6. Guaranteed by design.

## NCL30082

**Table 3. ELECTRICAL CHARACTERISTICS** (Unless otherwise noted: For typical values  $T_J = 25^\circ\text{C}$ ,  $V_{CC} = 12\text{ V}$ ; For min/max values  $T_J = -40^\circ\text{C}$  to  $+125^\circ\text{C}$ , Max  $T_J = 150^\circ\text{C}$ ,  $V_{CC} = 12\text{ V}$ )

Description	Test Condition	Symbol	Min	Typ	Max	Unit
<b>THERMAL FOLD-BACK AND OVP</b>						
Timer duration after which the controller is allowed to start pulsing		$t_{OTP(\text{start})}$	180	–	300	$\mu\text{s}$
Clamped voltage (SD pin left open)	SD pin open	$V_{SD(\text{clamp})}$	1.13	1.35	1.57	V
Clamp series resistor		$R_{SD(\text{clamp})}$	–	1.6	–	$\text{k}\Omega$
SD pin detection level for OVP	$V_{SD}$ increasing	$V_{OVP}$	2.35	2.5	2.65	V
Delay before OVP or OTP confirmation (OVP and OTP)		$T_{SD(\text{delay})}$	15	30	45	$\mu\text{s}$
<b>THERMAL SHUTDOWN</b>						
Thermal Shutdown (Note 6)	Device switching ( $F_{SW}$ around 65 kHz)	$T_{SHDN}$	130	150	170	$^\circ\text{C}$
Thermal Shutdown Hysteresis (Note 6)		$T_{SHDN(\text{HYS})}$	–	50	–	$^\circ\text{C}$
<b>BROWN-OUT</b>						
Brown-Out ON level (IC start pulsing)	$V_{SD}$ increasing	$V_{BO(\text{on})}$	0.90	1	1.10	V
Brown-Out OFF level (IC shuts down)	$V_{SD}$ decreasing	$V_{BO(\text{off})}$	0.85	0.9	0.95	V
BO comparators delay		$t_{BO(\text{delay})}$	–	30	–	$\mu\text{s}$
Brown-Out blanking time		$t_{BO(\text{blank})}$	35	50	65	ms
Brown-Out blanking time NCL30082D		$t_{BO(\text{blank})D}$	10.5	15	19.5	ms
Brown-out pin bias current		$I_{BO(\text{bias})}$	–250	–	250	nA

Product parametric performance is indicated in the Electrical Characteristics for the listed test conditions, unless otherwise noted. Product performance may not be indicated by the Electrical Characteristics if operated under different conditions.

6. Guaranteed by design.



TYPICAL CHARACTERISTICS

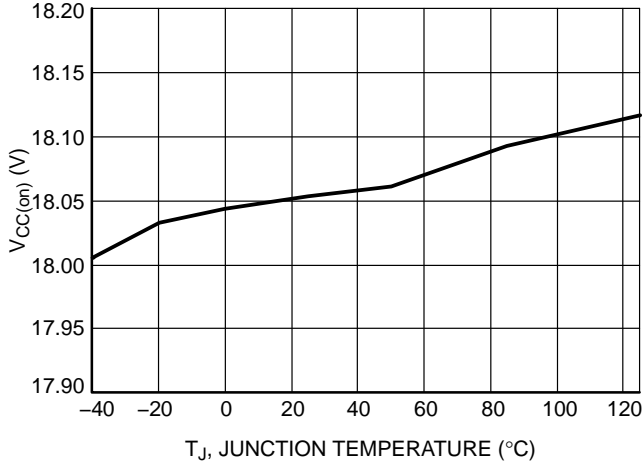

Figure 3.  $V_{CC(on)}$  vs. Junction Temperature

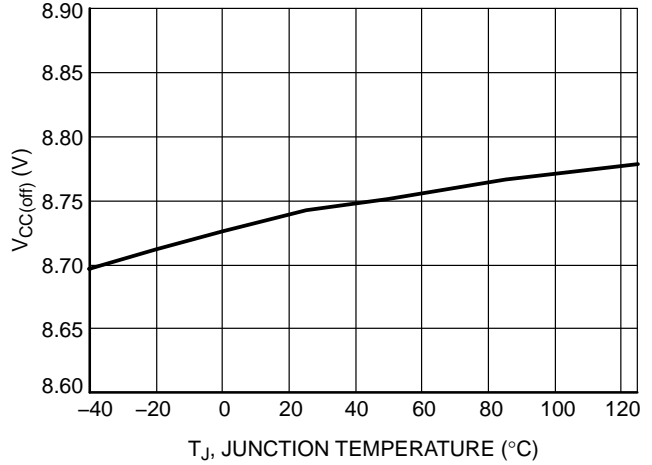

Figure 4.  $V_{CC(off)}$  vs. Junction Temperature

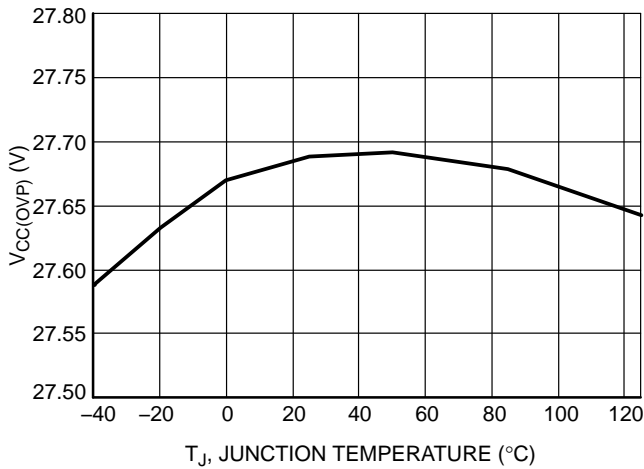

Figure 5.  $V_{CC(OVP)}$  vs. Junction Temperature

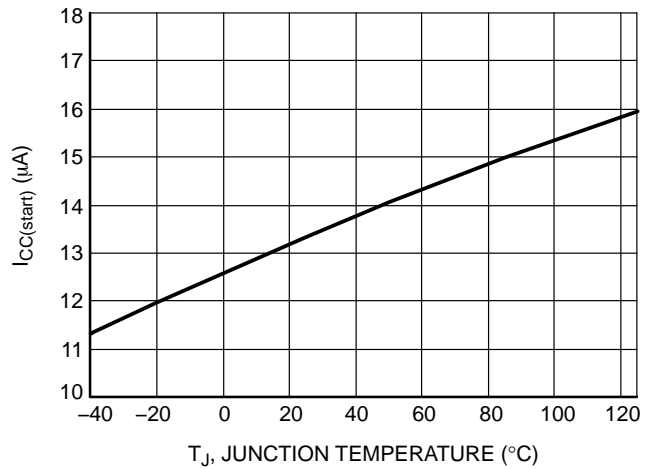

Figure 6.  $I_{CC(start)}$  vs. Junction Temperature

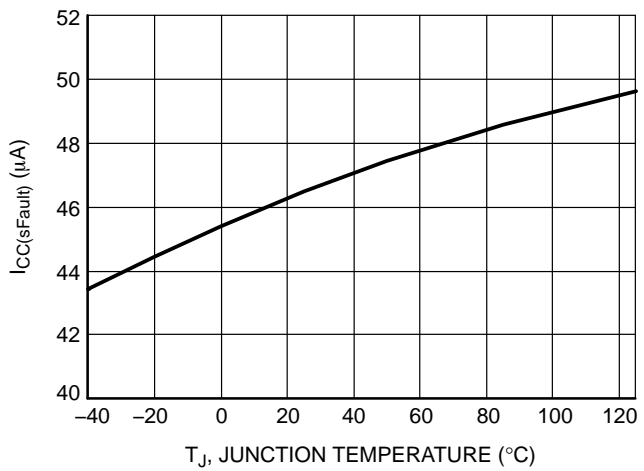

Figure 7.  $I_{CC(sFault)}$  vs. Junction Temperature

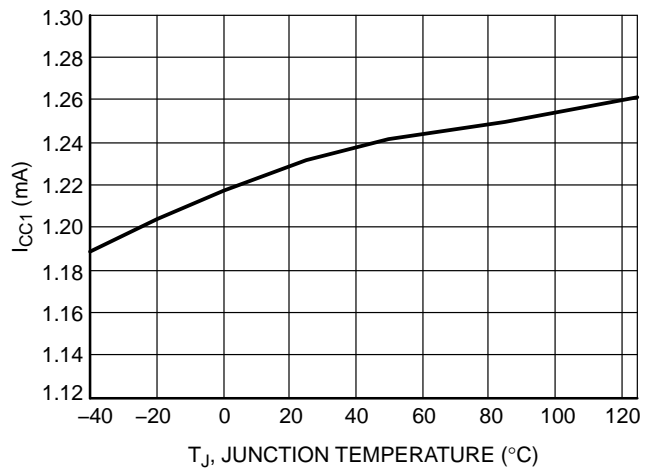

Figure 8.  $I_{CC1}$  vs. Junction Temperature

TYPICAL CHARACTERISTICS

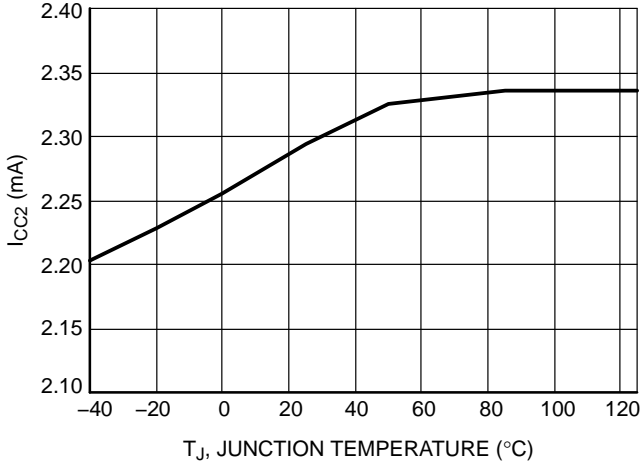

Figure 9.  $I_{CC2}$  vs. Junction Temperature

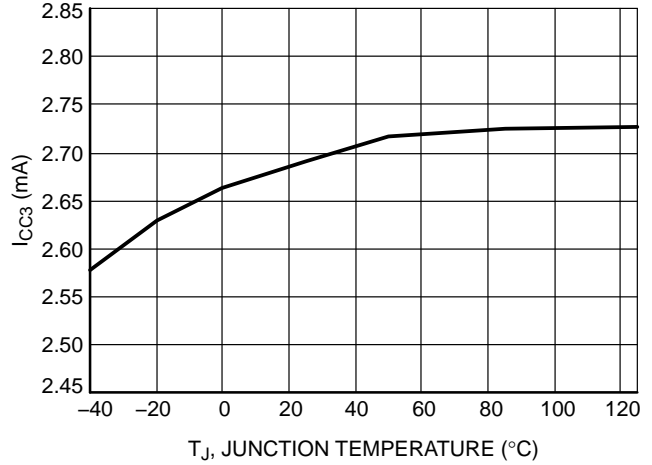

Figure 10.  $I_{CC3}$  vs. Junction Temperature

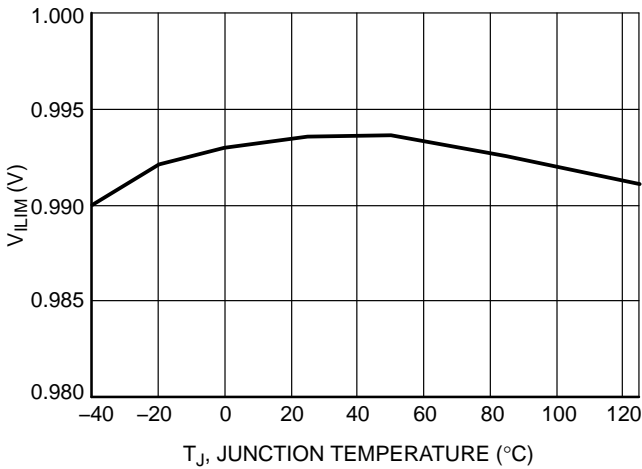

Figure 11.  $V_{ILIM}$  vs. Junction Temperature

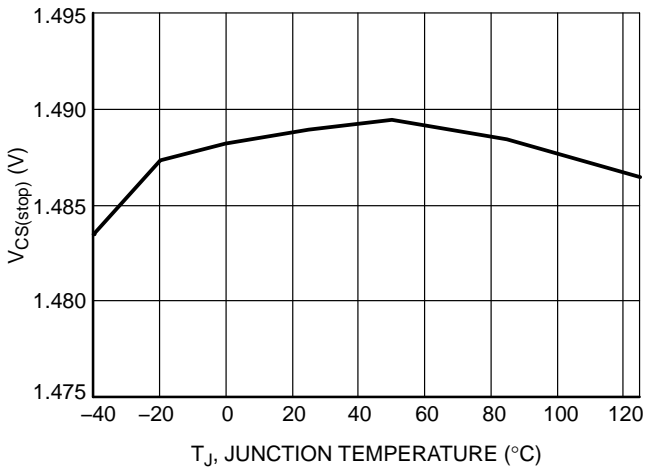

Figure 12.  $V_{CS(stop)}$  vs. Junction Temperature

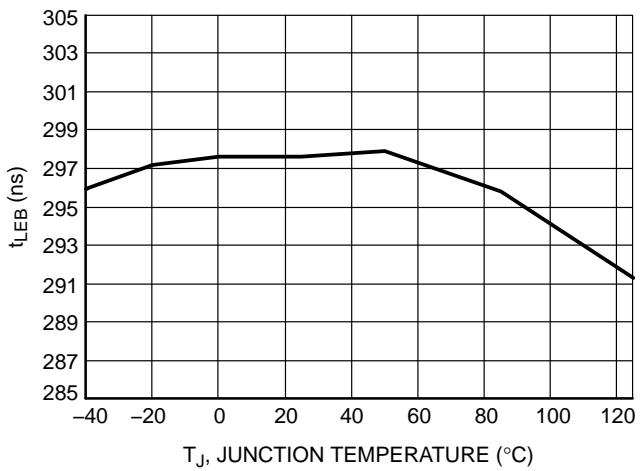

Figure 13.  $t_{LEB}$  vs. Junction Temperature

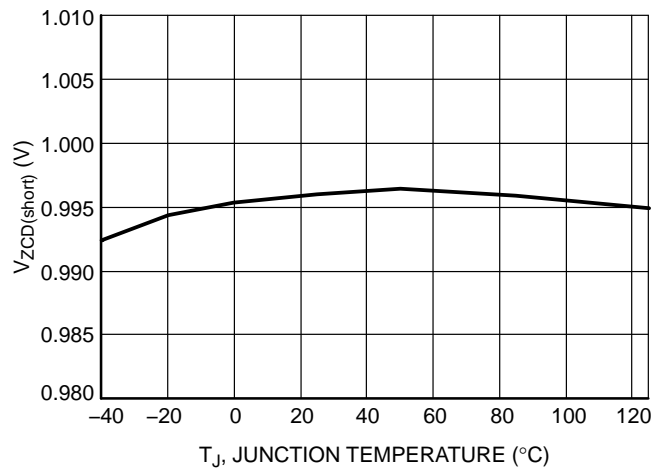

Figure 14.  $V_{ZCD(short)}$  vs. Junction Temperature

TYPICAL CHARACTERISTICS

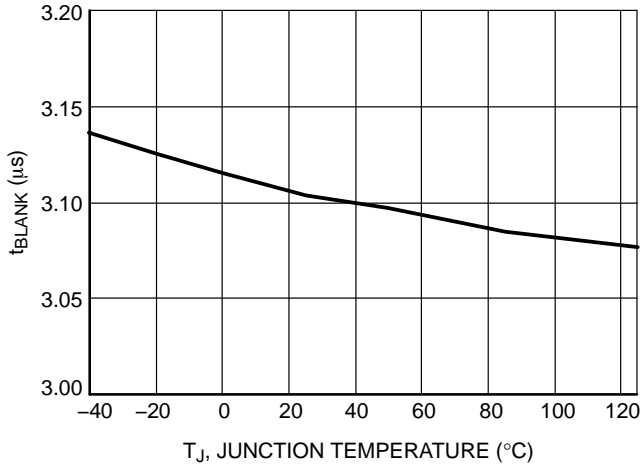

Figure 15.  $t_{BLANK}$  vs. Junction Temperature

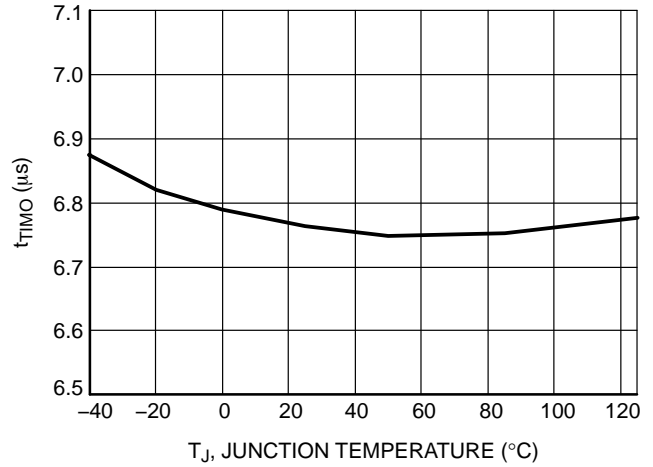

Figure 16.  $t_{TIMO}$  vs. Junction Temperature

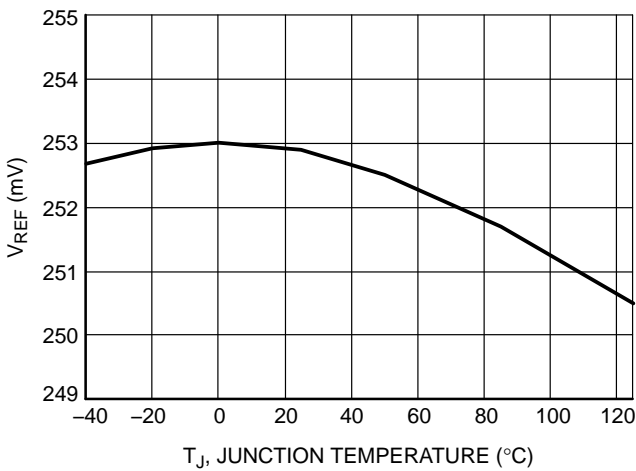

Figure 17.  $V_{REF}$  vs. Junction Temperature

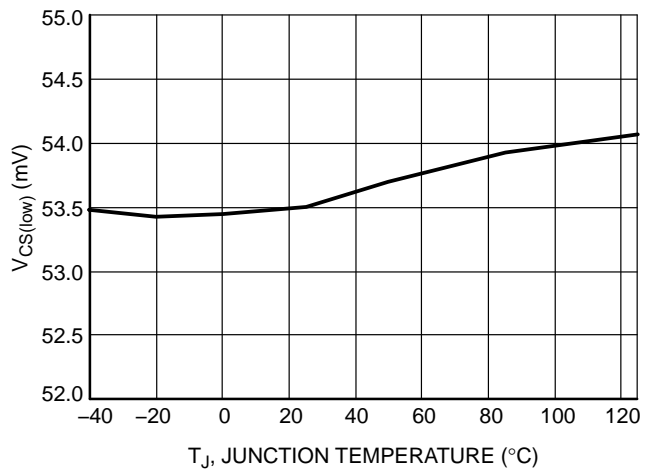

Figure 18.  $V_{CS(low)}$  vs. Junction Temperature

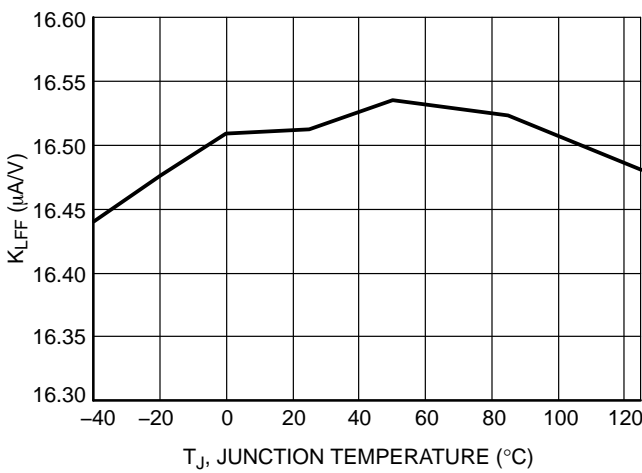

Figure 19.  $K_{LFF}$  vs. Junction Temperature

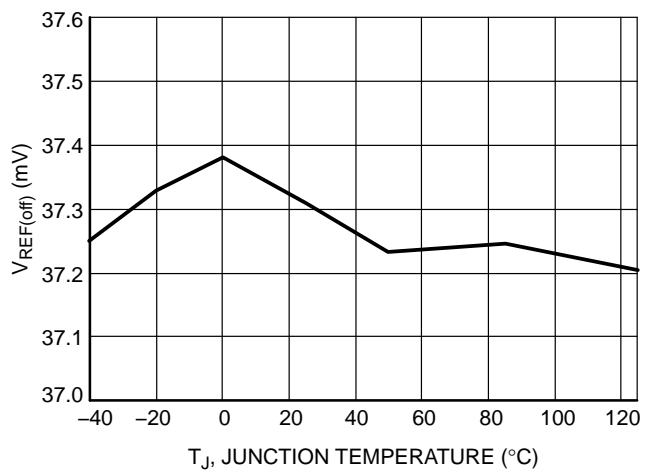

Figure 20.  $V_{REF(off)}$  vs. Junction Temperature

TYPICAL CHARACTERISTICS

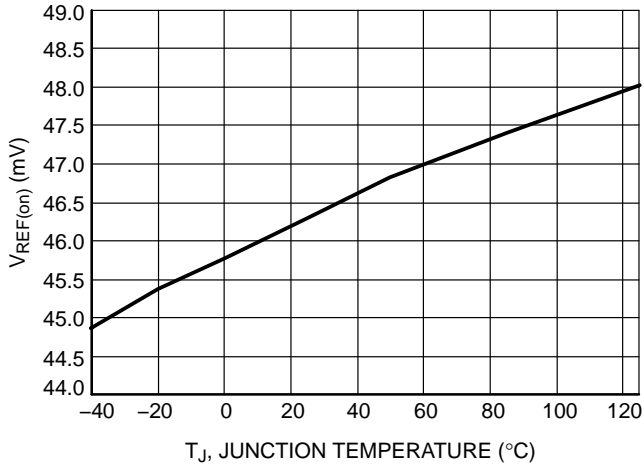

Figure 21. V<sub>REF(on)</sub> vs. Junction Temperature

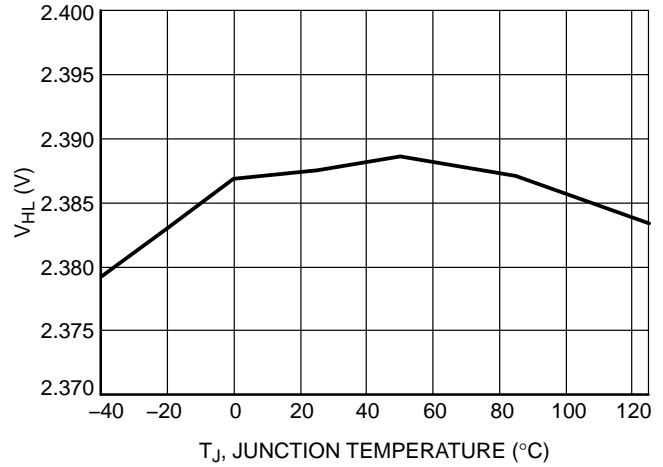

Figure 22. V<sub>HL</sub> vs. Junction Temperature

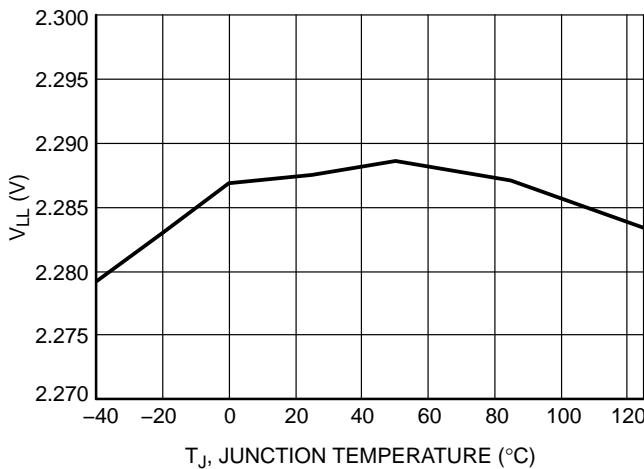

Figure 23. V<sub>LL</sub> vs. Junction Temperature

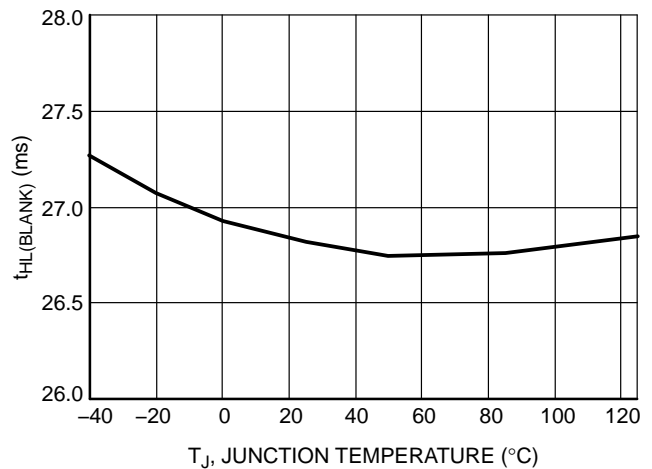

Figure 24. t<sub>HL(BLANK)</sub> vs. Junction Temperature

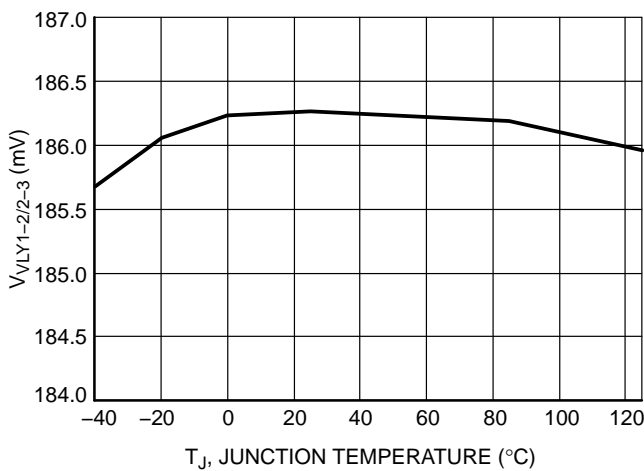

Figure 25. V<sub>VLY1-2/2-3</sub> vs. Junction Temperature

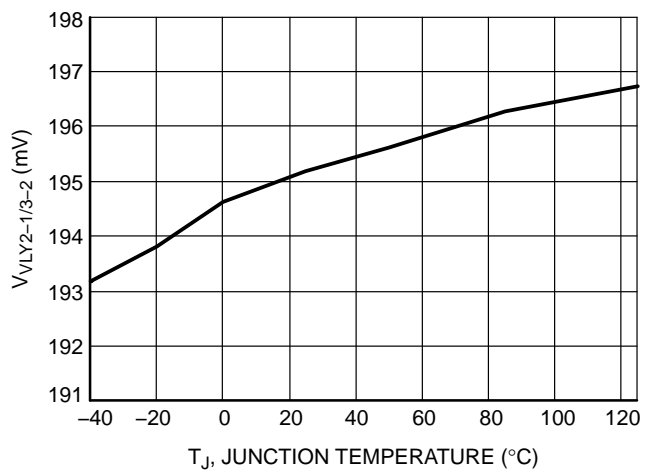

Figure 26. V<sub>VLY2-1/3-2</sub> vs. Junction Temperature

TYPICAL CHARACTERISTICS

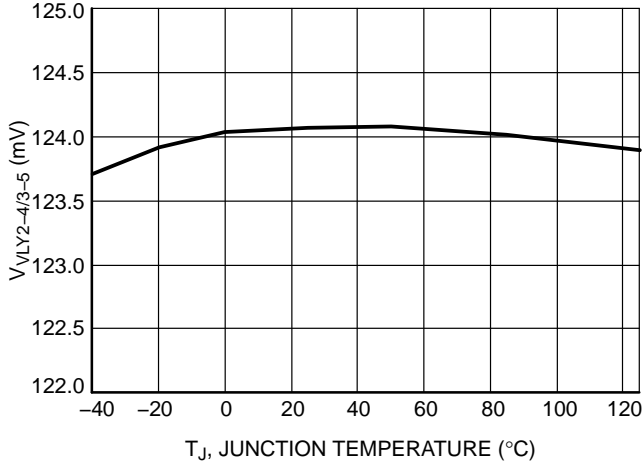

Figure 27.  $V_{VLY2-4/3-5}$  vs. Junction Temperature

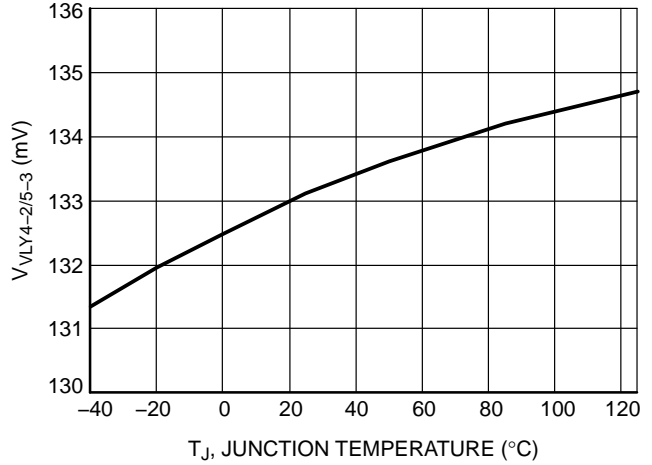

Figure 28.  $V_{VLY4-2/5-3}$  vs. Junction Temperature

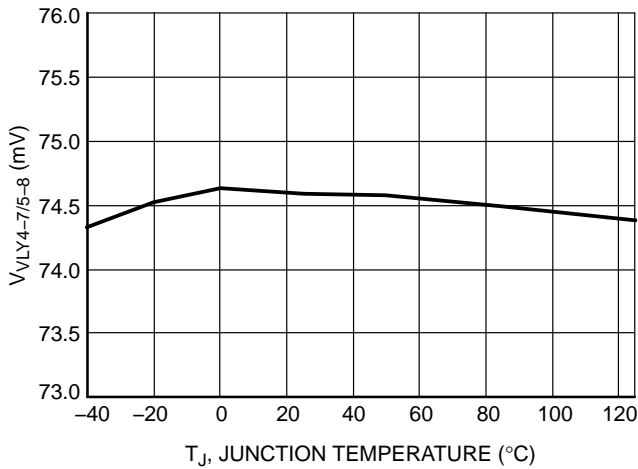

Figure 29.  $V_{VLY4-7/5-8}$  vs. Junction Temperature

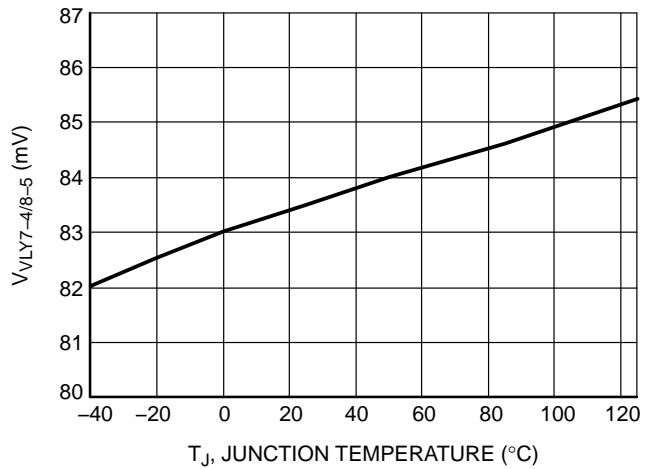

Figure 30.  $V_{VLY7-4/8-5}$  vs. Junction Temperature

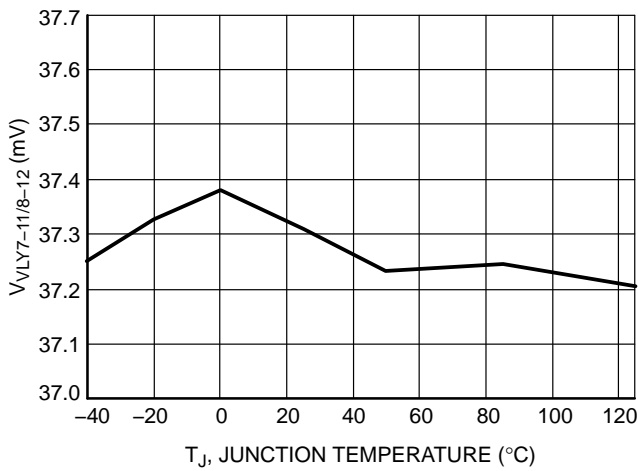

Figure 31.  $V_{VLY7-11/8-12}$  vs. Junction Temperature

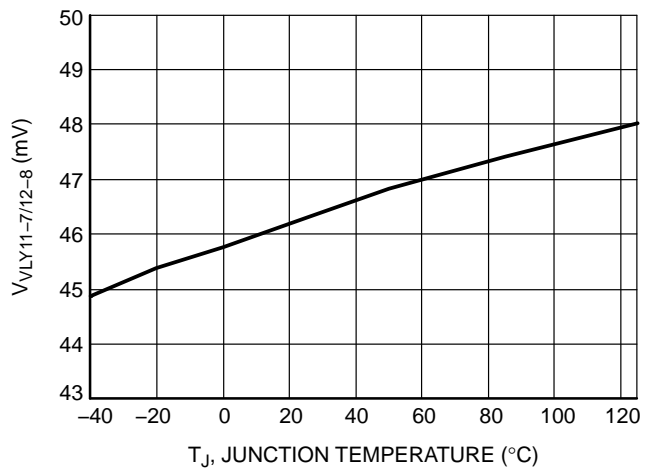

Figure 32.  $V_{VLY11-7/12-8}$  vs. Junction Temperature

TYPICAL CHARACTERISTICS

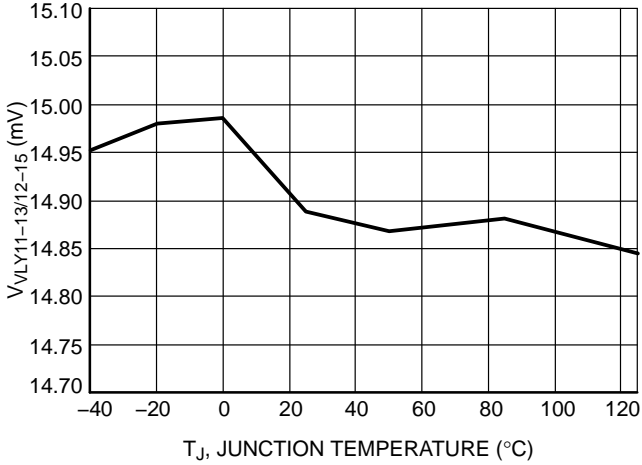

Figure 33. V<sub>VLY11-13/12-15</sub> vs. Junction Temperature

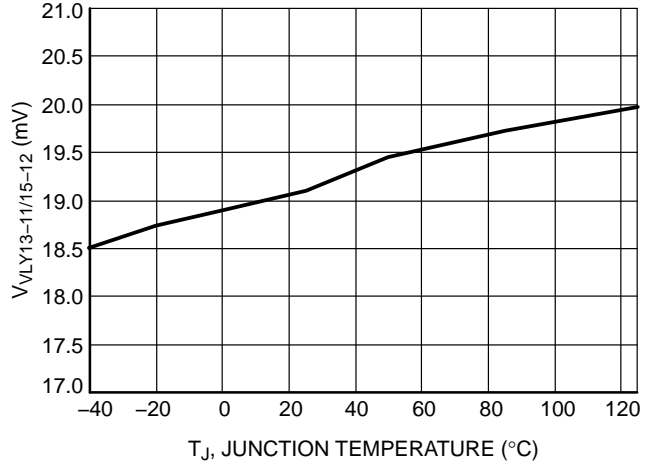

Figure 34. V<sub>VLY13-11/15-12</sub> vs. Junction Temperature

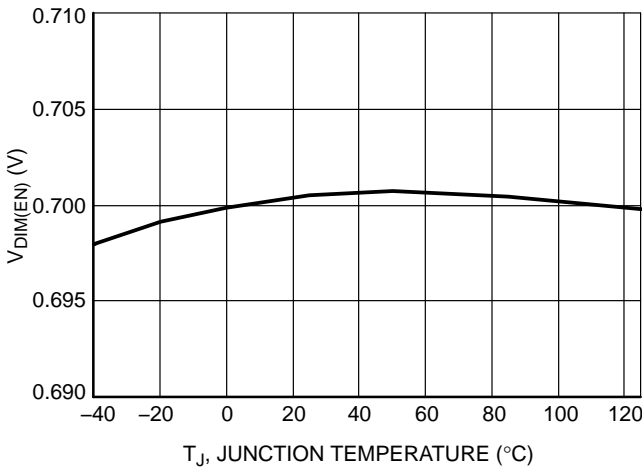

Figure 35. V<sub>DIM(EN)</sub> vs. Junction Temperature

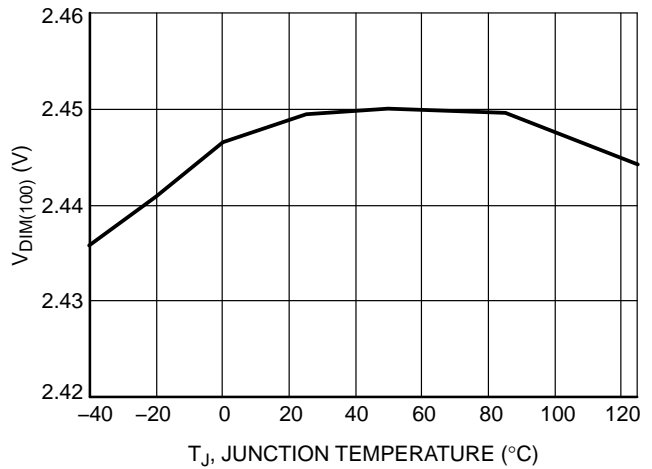

Figure 36. V<sub>DIM(100)</sub> vs. Junction Temperature

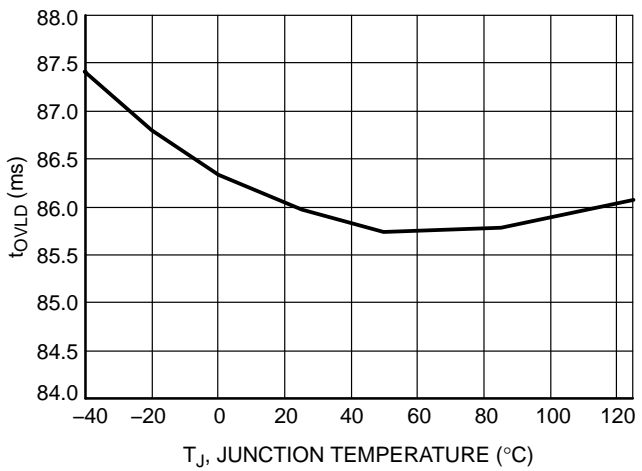

Figure 37. t<sub>OVLD</sub> vs. Junction Temperature

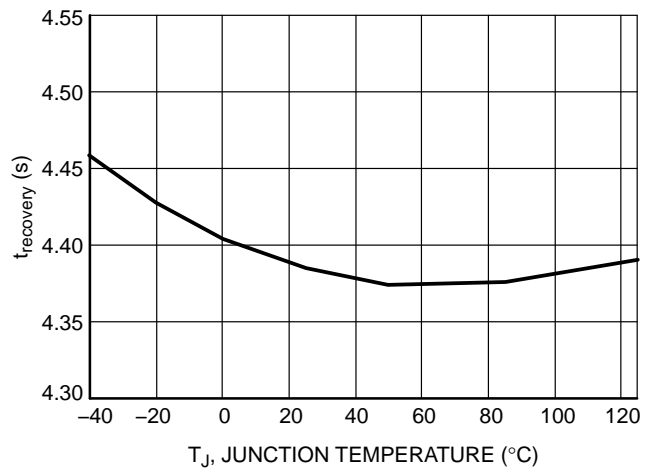

Figure 38. t<sub>recovery</sub> vs. Junction Temperature

TYPICAL CHARACTERISTICS

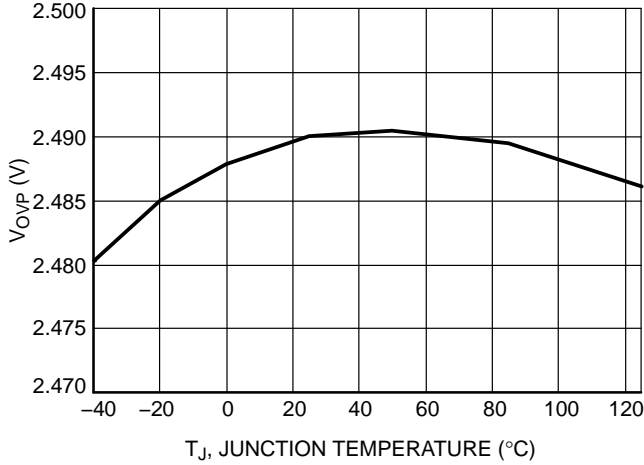

Figure 39.  $V_{OVP}$  vs. Junction Temperature

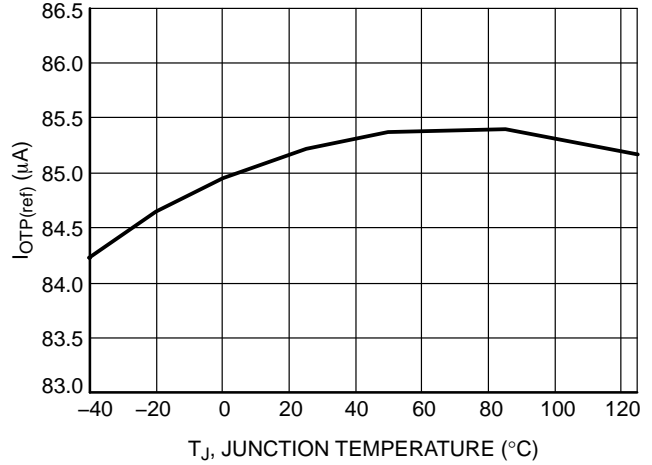

Figure 40.  $I_{OTP(ref)}$  vs. Junction Temperature

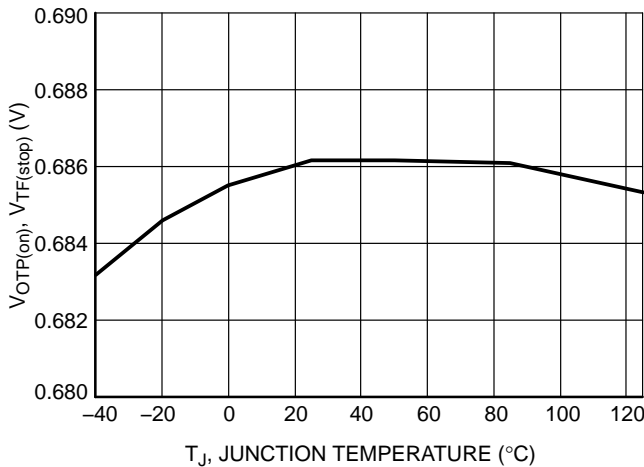

Figure 41.  $V_{OTP(on)}$ ,  $V_{TF(stop)}$  vs. Junction Temperature

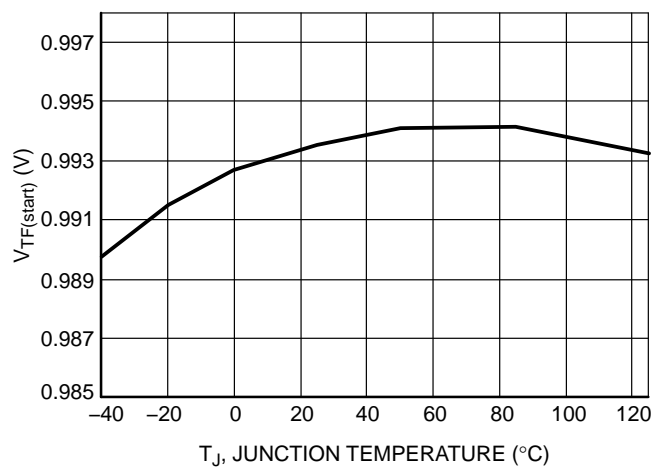

Figure 42.  $V_{TF(start)}$  vs. Junction Temperature

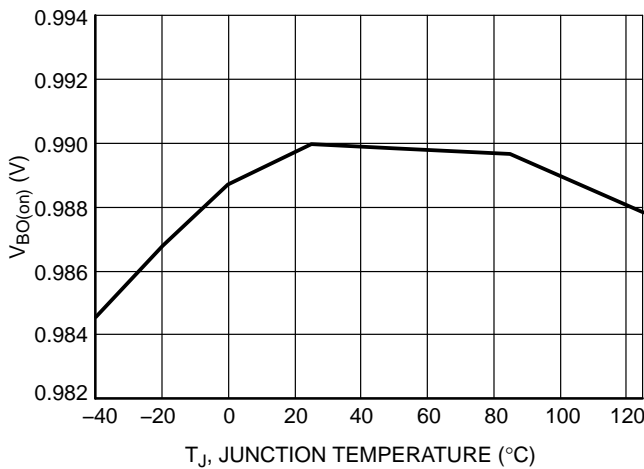

Figure 43.  $V_{BO(on)}$  vs. Junction Temperature

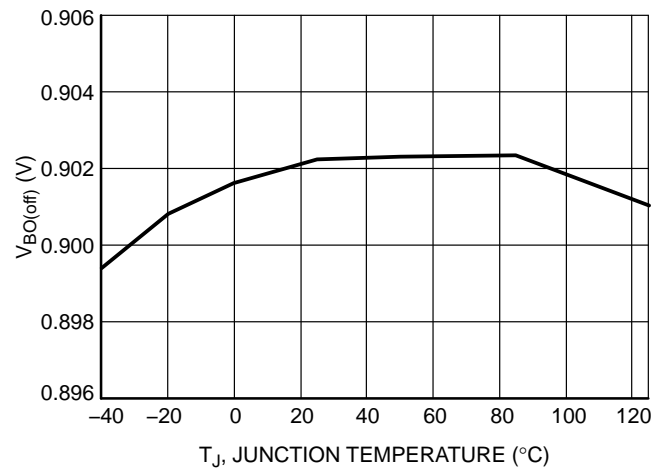

Figure 44.  $V_{BO(off)}$  vs. Junction Temperature

TYPICAL CHARACTERISTICS

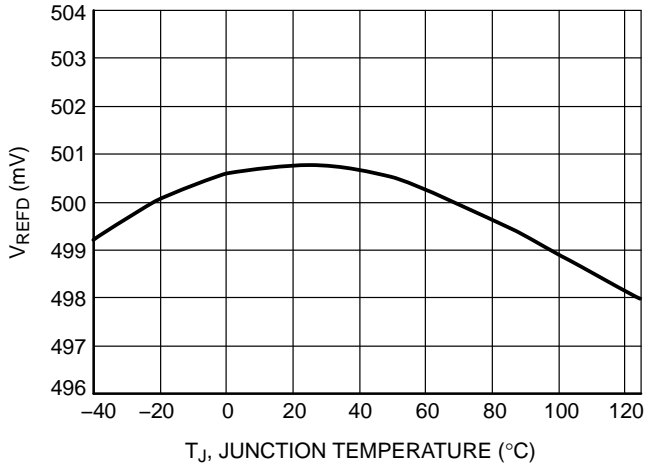

Figure 45.  $V_{REFD}$  vs. Junction Temperature

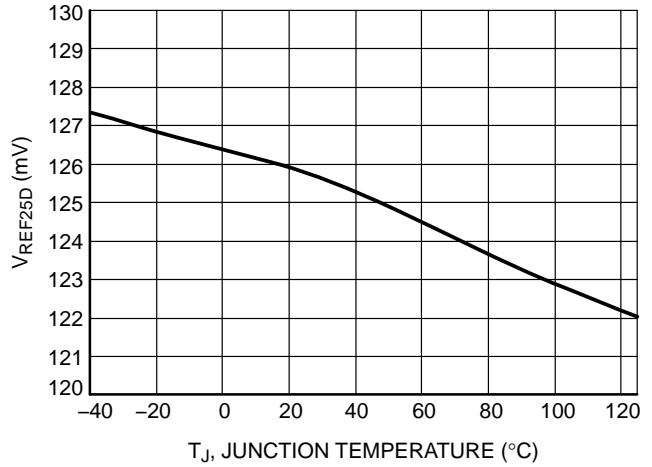

Figure 46.  $V_{REF25D}$  vs. Junction Temperature

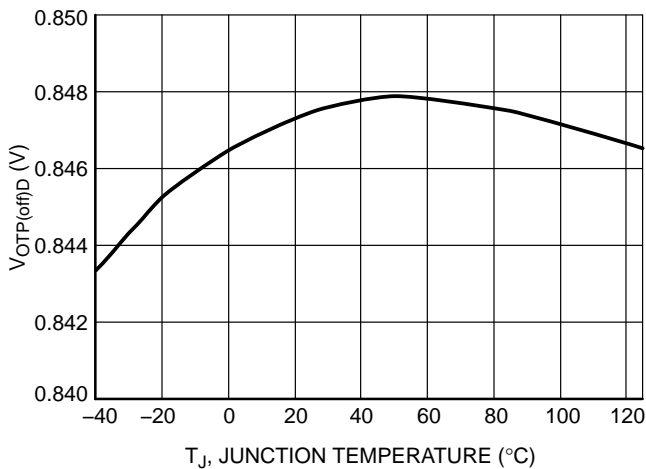

Figure 47.  $V_{OTP(off)D}$  vs. Junction Temperature

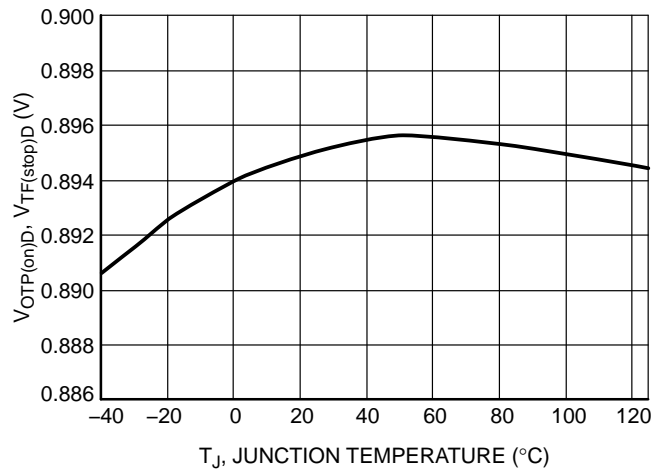

Figure 48.  $V_{OTP(on)D}, V_{TF(stop)D}$  vs. Junction Temperature

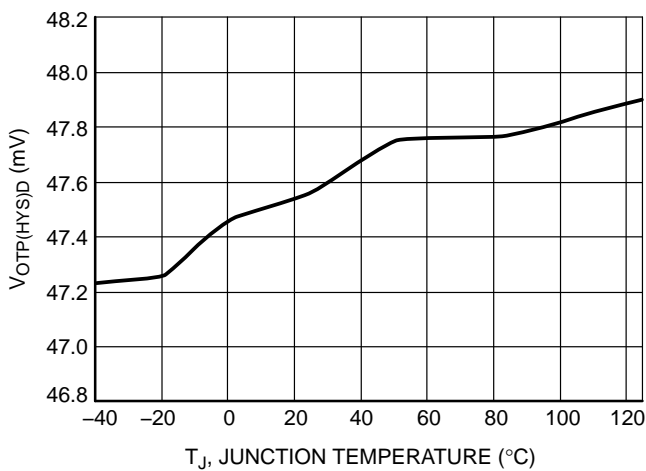

Figure 49.  $V_{OTP(HYS)D}$  vs. Junction Temperature

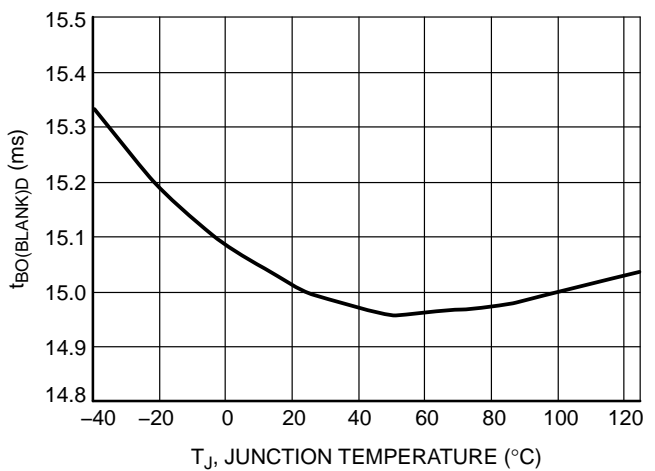
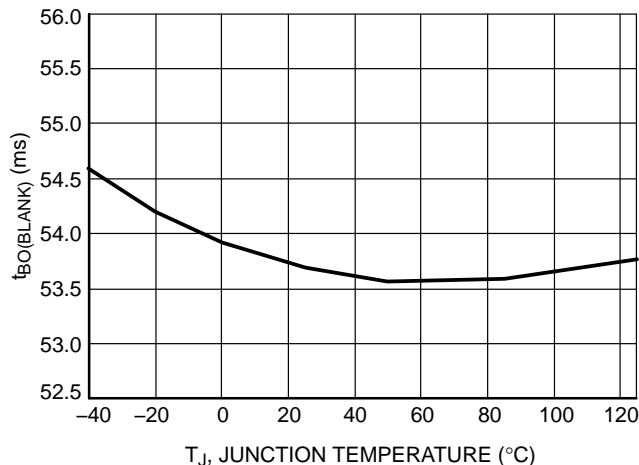

Figure 50.  $t_{BO(BLANK)D}$  vs. Junction Temperature



## TYPICAL CHARACTERISTICS

Figure 51. t<sub>BO(BLANK)</sub> vs. Junction Temperature

## APPLICATION INFORMATION

The NCL30082 implements a current-mode architecture operating in quasi-resonant mode. Thanks to proprietary circuitry, the controller is able to accurately regulate the secondary side current of the flyback converter without using any opto-coupler or measuring directly the secondary side current.

- **Quasi-Resonance Current-Mode Operation:** implementing quasi-resonance operation in peak current-mode control, the NCL30082 optimizes the efficiency by switching in the valley of the MOSFET drain-source voltage. Thanks to a smart control algorithm, the controller locks-out in a selected valley and remains locked until the input voltage or the output current set point significantly changes.
- **Primary Side Constant Current Control:** thanks to a proprietary circuit, the controller is able to compensate for the leakage inductance of the transformer and allow accurate control of the secondary side current.
- **Line Feed-forward:** compensation for possible variation of the output current caused by system slew rate variation.
- **Open LED protection:** if the voltage on the VCC pin exceeds an internal limit, the controller shuts down and waits 4 seconds before restarting switching.
- **Thermal Fold-back / Over Temperature / Over Voltage Protection:** by combining a dual threshold on the SD pin, the controller allows the direct connection of an NTC to ground plus a Zener diode to a monitored voltage. The temperature is monitored and the output current is linearly reduced in the event that the

temperature exceeds a prescribed level. If the temperature continues to increase, the current will be further reduced until the controller is stopped. The control will automatically restart if the temperature is reduced. This pin can implement a programmable OVP shutdown that can also auto-restart the device.

- **Brown-Out:** the controller includes a brown-out circuit which safely stops the controller in case the input voltage is too low. The device will automatically restart if the line recovers.
- **Cycle-by-cycle peak current limit:** when the current sense voltage exceeds the internal threshold  $V_{ILIM}$ , the MOSFET is turned off for the rest of the switching cycle.
- **Winding Short-Circuit Protection:** an additional comparator with a short LEB filter ( $t_{BCS}$ ) senses the CS signal and stops the controller if  $V_{CS}$  reaches  $1.5 \times V_{ILIM}$ . For noise immunity reasons, this comparator is enabled only during the main LEB duration  $t_{LEB}$ .
- **Output Short-circuit protection:** If a very low voltage is applied on ZCD pin for 90 ms (nominal), the controllers assume that the output or the ZCD pin is shorted to ground and enters shutdown. The auto-restart version (B suffix) waits 4 seconds, then the controller restarts switching. In the latched version (A suffix), the controller is latched as long as  $V_{CC}$  stays above the  $V_{CC(reset)}$  threshold.
- **Linear or PWM dimming:** the DIM pin allows implementing both analog and PWM dimming.

**Constant Current Control**

Figure 53 portrays the primary and secondary current of a flyback converter in discontinuous conduction mode (DCM). Figure 52 shows the basic circuit of a flyback converter.

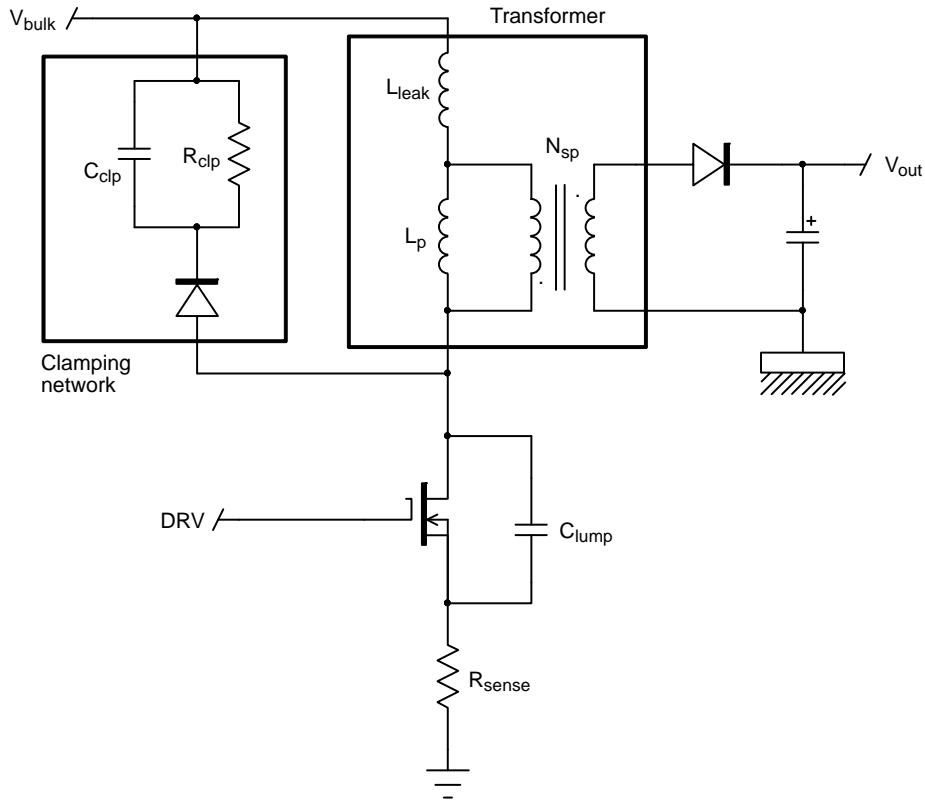

**Figure 52. Basic Flyback Converter Schematic**

During the on-time of the MOSFET, the bulk voltage  $V_{bulk}$  is applied to the magnetizing and leakage inductors  $L_p$  and  $L_{leak}$  and the current ramps up.

When the MOSFET is turned-off, the inductor current first charges  $C_{lump}$ . The output diode is off until the voltage across  $L_p$  reverses and reaches:

$$N_{sp}(V_{out} + V_f) \tag{eq. 1}$$

The output diode current increase is limited by the leakage inductor. As a consequence, the secondary peak current is reduced:

$$I_{D,pk} < \frac{I_{L,pk}}{N_{sp}} \tag{eq. 2}$$

The diode current reaches its peak when the leakage inductor is reset. Thus, in order to accurately regulate the output current, we need to take into account the leakage inductor current. This is accomplished by sensing the clamping network current. Practically, a node of the clamp capacitor is connected to  $R_{sense}$  instead of the bulk voltage  $V_{bulk}$ . Then, by reading the voltage on the CS pin, we have an image of the primary current (red curve in Figure 53).

When the diode conducts, the secondary current decreases linearly from  $I_{D,pk}$  to zero. When the diode current has turned off, the drain voltage begins to oscillate because of the resonating network formed by the inductors ( $L_p + L_{leak}$ ) and the lump capacitor. This voltage is reflected on the auxiliary winding wired in flyback mode. Thus, by looking at the auxiliary winding voltage, we can detect the end of the conduction time of secondary diode. The constant current control block picks up the leakage inductor current, the end of conduction of the output rectifier and controls the drain current to maintain the output current constant.

We have:

$$I_{out} = \frac{V_{REF}}{2N_{sp}R_{sense}} \tag{eq. 3}$$

The output current value is set by choosing the sense resistor:

$$R_{sense} = \frac{V_{ref}}{2N_{sp}I_{out}} \tag{eq. 4}$$

From Equation 3, the first key point is that the output current is independent of the inductor value. Moreover, the leakage inductance does not influence the output current value as the reset time is taken into account by the controller.

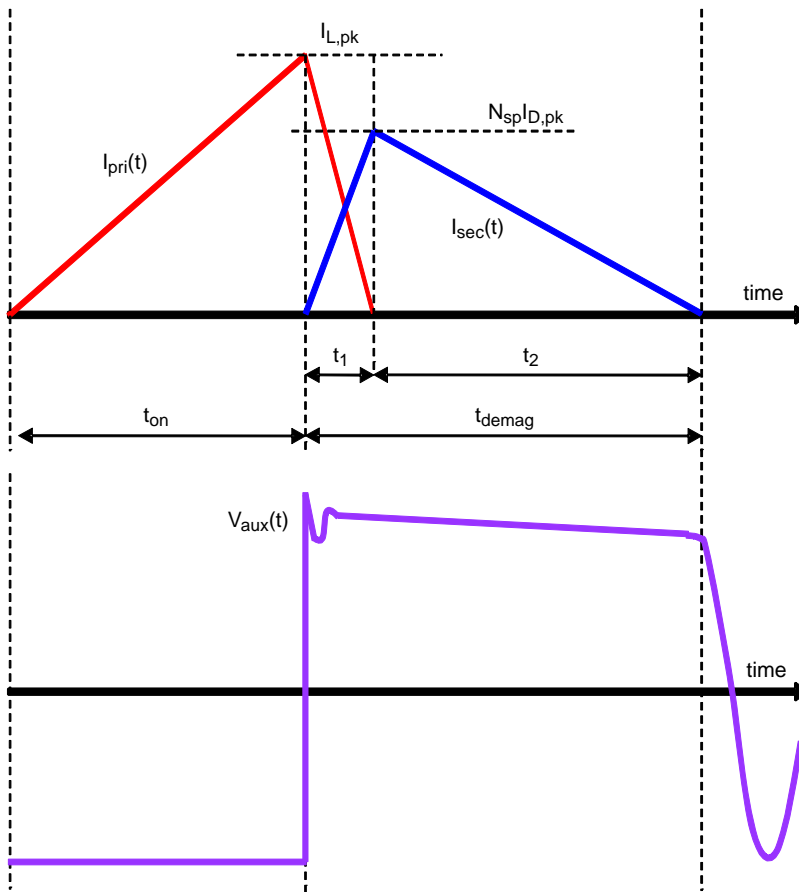

Figure 53. Flyback Currents and Auxiliary Winding Voltage in DCM

**Internal Soft-Start**

At startup or after recovering from a fault, there is a small internal soft-start of 40  $\mu$ s.

In addition, during startup, as the output voltage is zero volts, the demagnetization time is long and the constant

current control block will slowly increase the peak current towards its nominal value as the output voltage grows. Figure 54 shows a soft-start simulation example for a 9 W LED power supply.

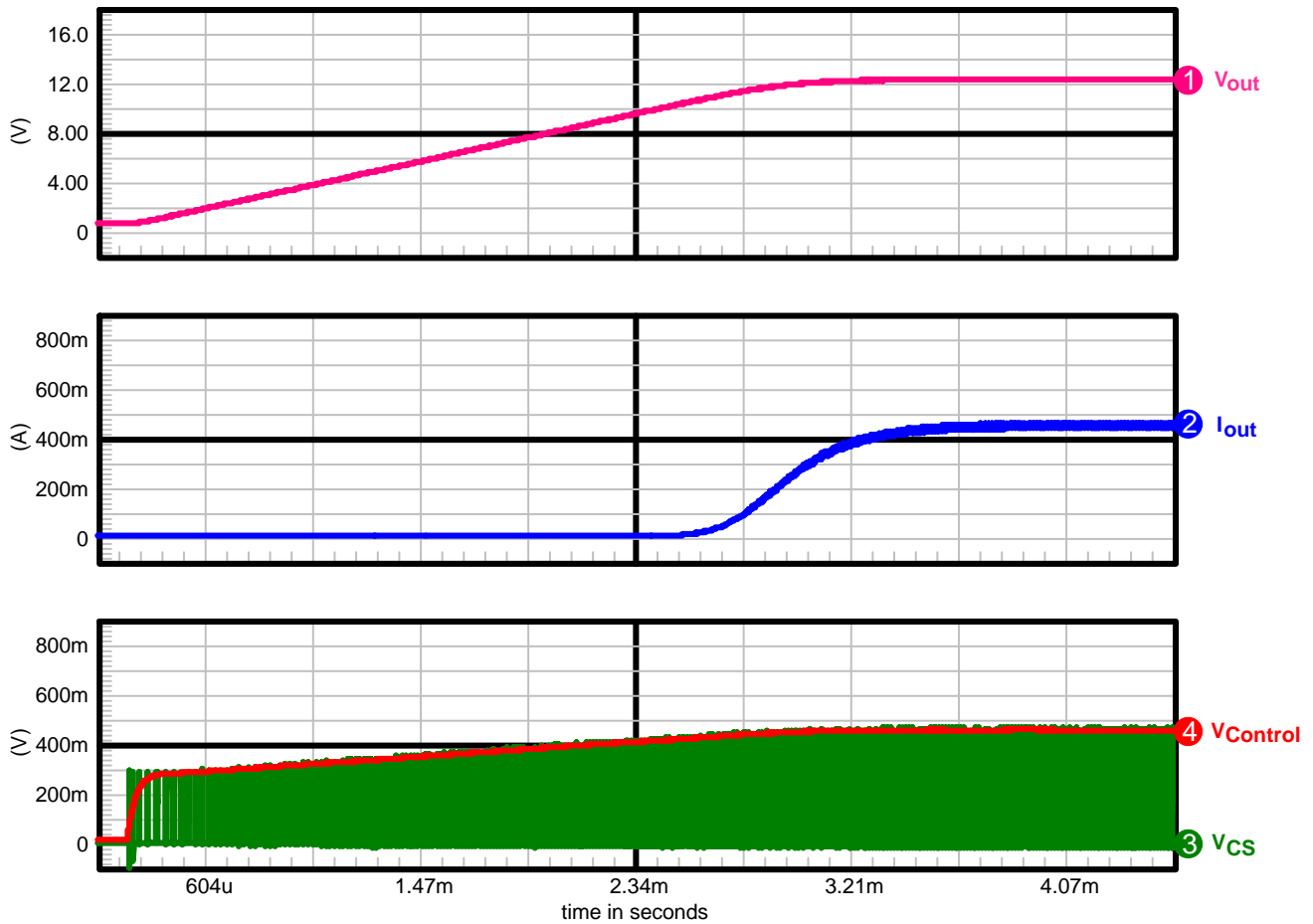

Figure 54. Startup Simulation Showing the Natural Soft-start

#### Cycle-by-Cycle Current Limit

When the current sense voltage exceeds the internal threshold  $V_{ILIM}$ , the MOSFET is turned off for the rest of the switching cycle (Figure 55).

#### Winding and Output Diode Short-Circuit Protection

In parallel with the cycle-by-cycle sensing of the CS pin, another comparator with a reduced LEB ( $t_{BCS}$ ) and a higher threshold (1.5 V typical) is able to sense winding short-circuit and immediately stops the DRV pulses. The controller goes into auto-recovery mode in version B, B1, B2, B3 and D.

In version A, the controller is latched. In latch mode, the DRV pulses stop and VCC ramps up and down. The circuit un-latches when VCC pin voltage drops below  $V_{CC(reset)}$  threshold.

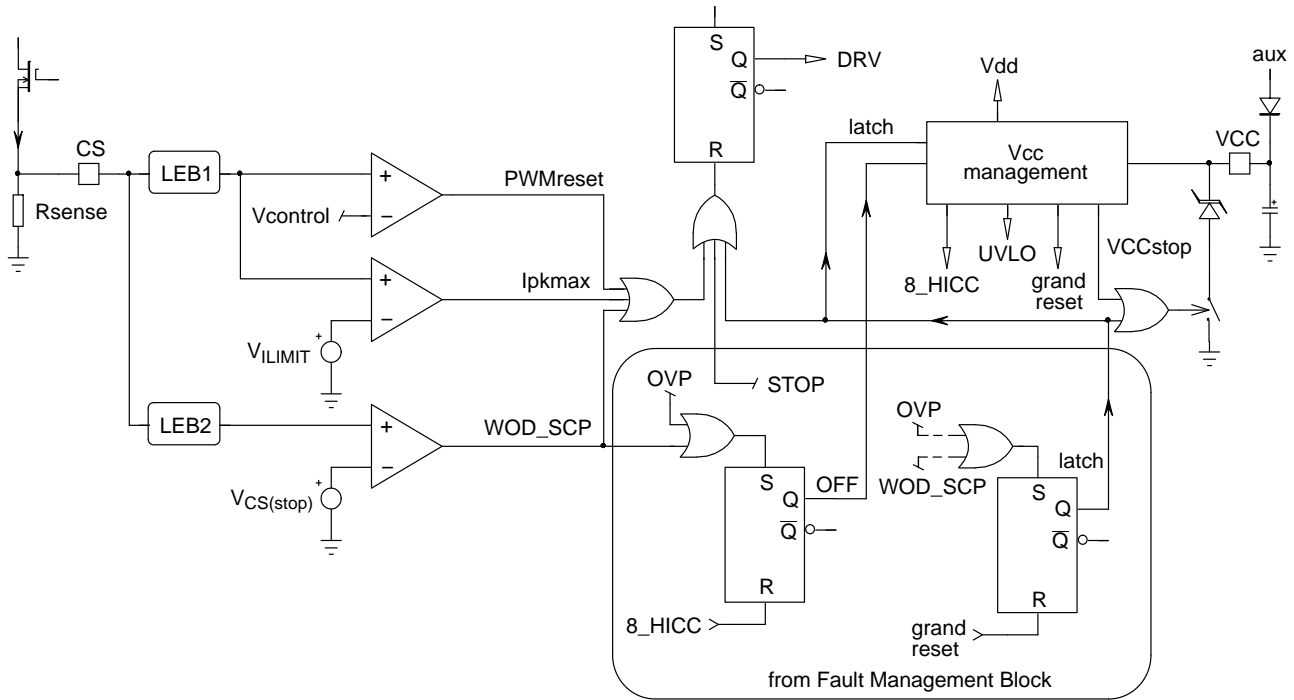

Figure 55. Winding Short Circuit Protection, Max. Peak Current Limit Circuits

**Thermal Fold-back and Over Voltage / Over Temperature Protection**

The thermal fold-back circuit reduces the current in the LED string when the ambient temperature exceeds a set point. The current is gradually reduced to 50% of its nominal value if the temperature continues to rise. (Figure 56). The thermal foldback starting temperature depends of the Negative Coefficient Temperature (NTC) resistor chosen by the power supply designer.

Indeed, the SD pin allows the direct connection of an NTC to sense the ambient temperature. When the SD pin voltage  $V_{SD}$  drops below  $V_{TF(start)}$ , the internal reference for the

constant current control  $V_{REF}$  is decreased proportionally to  $V_{SD}$ . When  $V_{SD}$  reaches  $V_{TF(stop)}$ ,  $V_{REF}$  is clamped to  $V_{REF50}$ , corresponding to 50% of the nominal output current (versions A, B, B1, B2, B3). For the NCL30082D, the output current is decreased to 25% of the nominal output current.

If  $V_{SD}$  drops below  $V_{OTP}$ , the controller enters into the auto-recovery fault mode for version B, B1, B2, B3 and D meaning that the 4-s timer is activated. The controller will re-start switching after the 4-s timer has elapsed and when  $V_{SD} > V_{OTP(on)}$  to provide some temperature hysteresis.

For version A, this protection is latched: reset occurs when  $V_{CC} < V_{CC(reset)}$ .

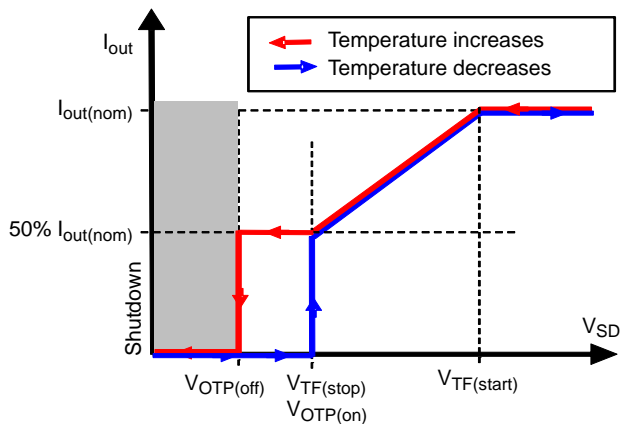

Figure 56. Output Current Reduction vs. SD Pin Voltage for NCL30082 Versions A, B, B1, B2, B3

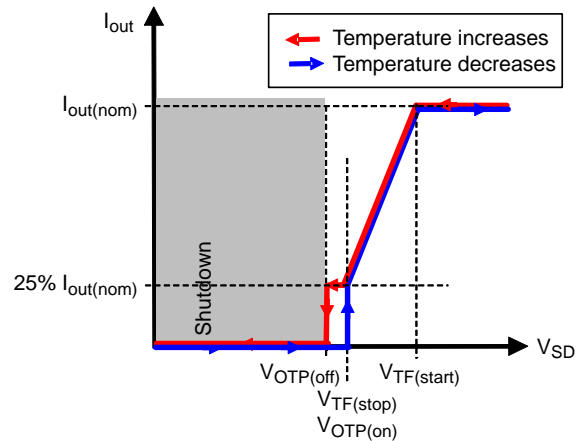
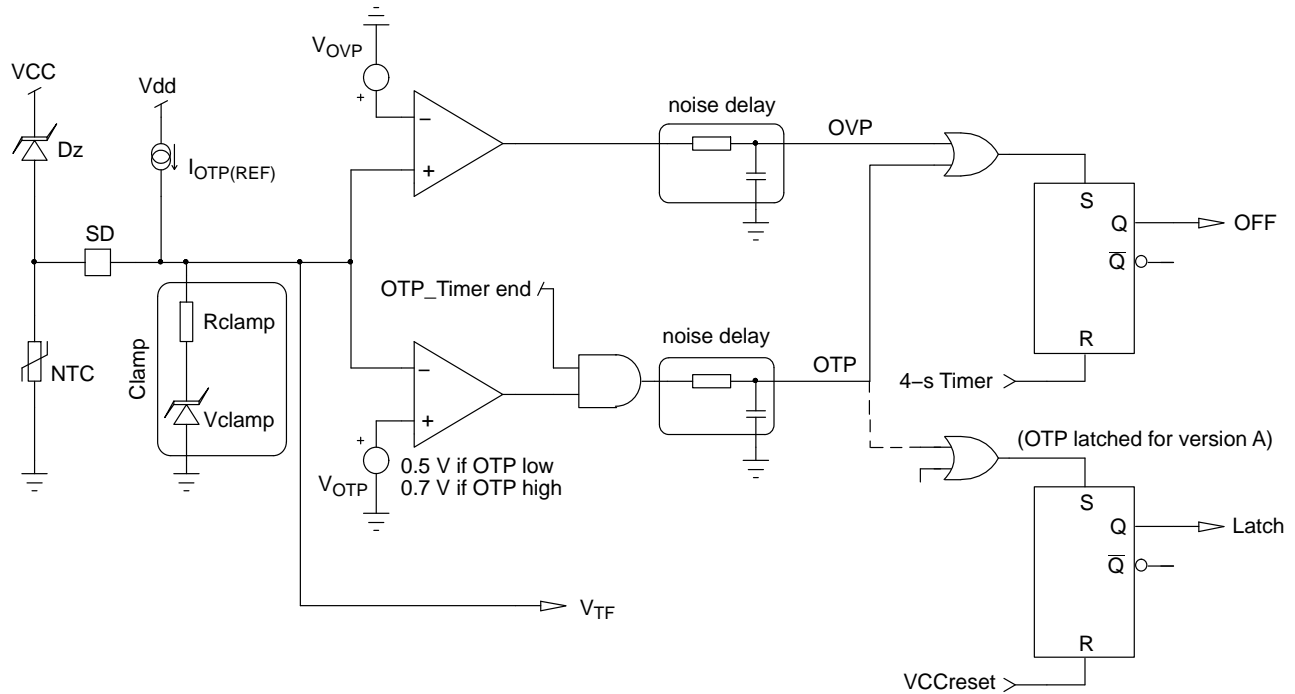

Figure 57. Output Current Reduction vs. SD Pin Voltage for NCL30082D

## NCL30082

At startup, when  $V_{CC}$  reaches  $V_{CC(on)}$ , the controller is not allowed to start pulsing for at least  $180\ \mu\text{s}$  in order to allow the SD pin voltage to reach its nominal value if a

filtering capacitor is connected to the SD pin. This is to avoid flickering of the LED light in case of over temperature.



**Figure 58. Thermal Fold-back and OVP/OTP Circuitry**

In the case of excess voltage, the Zener diode starts to conduct and inject current into the internal clamp resistor  $R_{clamp}$  thus causing the pin SD voltage to increase. When

this voltage reaches the OVP threshold (2.5 V typ.), the controller shuts-down and waits for at least 4 seconds before restarting switching.

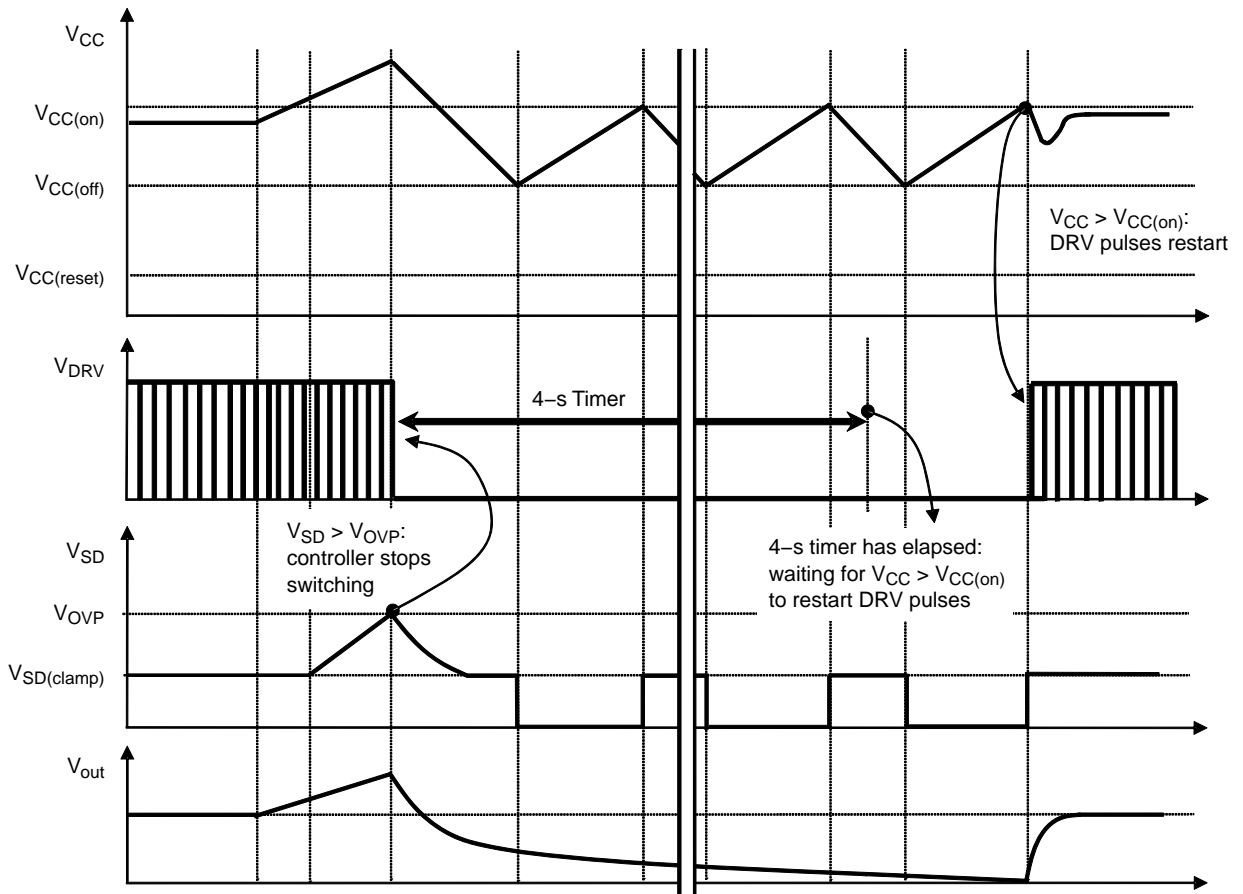

Figure 59. OVP with SD Pin Chronograms

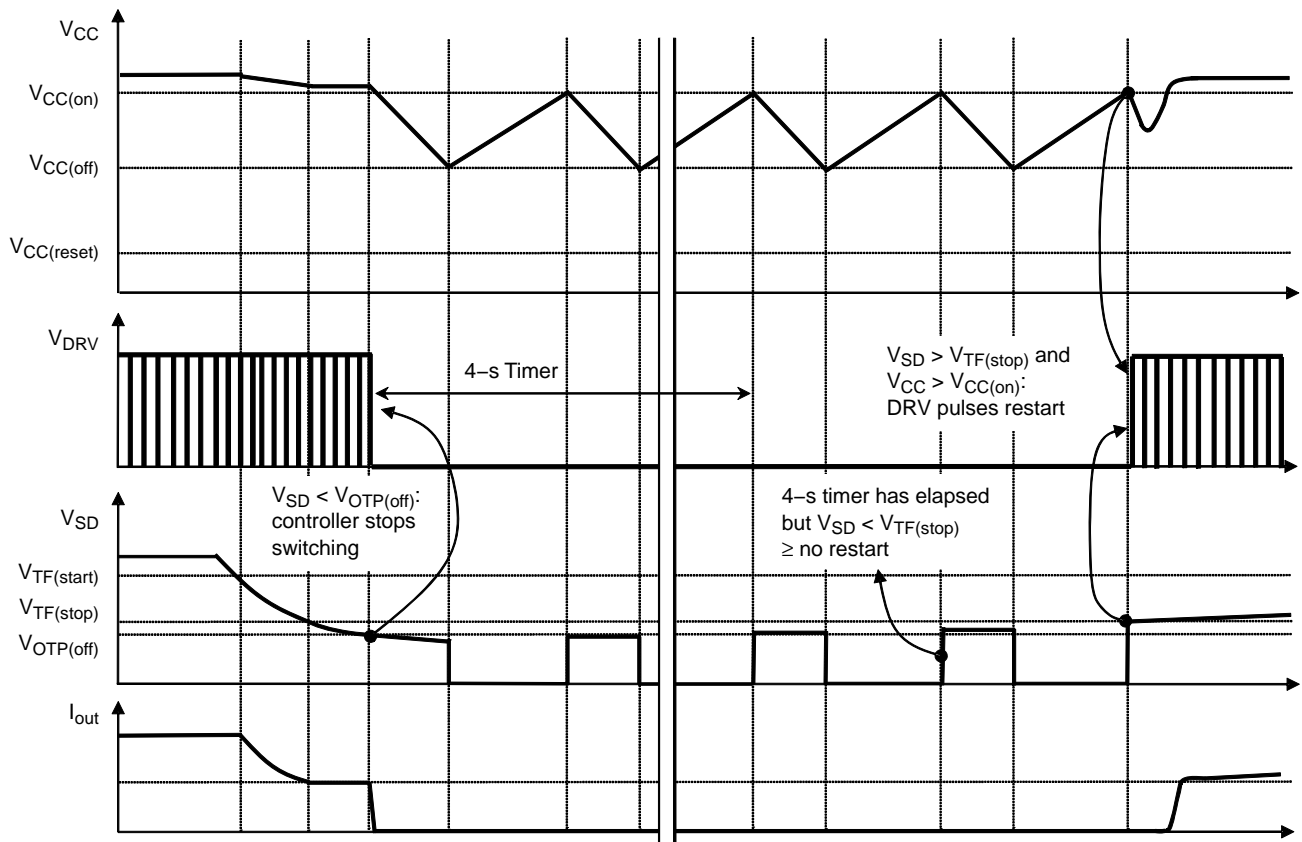

Figure 60. Thermal Fold-back / OTP Chronograms

**PWM or Linear Dimming Detection**

The pin DIM allows implementing either linear dimming or PWM dimming of the LED light.

If the power supply designer apply an analog signal varying from  $V_{DIM(EN)}$  to  $V_{DIM100}$  to the DIM pin, the output current will increase or decrease proportionally to the voltage applied. For  $V_{DIM} = V_{DIM100}$ , the power supply delivers the maximum output current.

If a voltage lower than  $V_{DIM(EN)}$  is applied to the DIM pin, the DRV pulses are disabled. Thus, for PWM dimming, a PWM signal with a low state value  $< V_{DIM(EN)}$  and a high state value  $> V_{DIM100}$  should be applied.

The DIM pin is pulled up internally by a small current source. Thus, if the pin is left open, the controller is able to start.

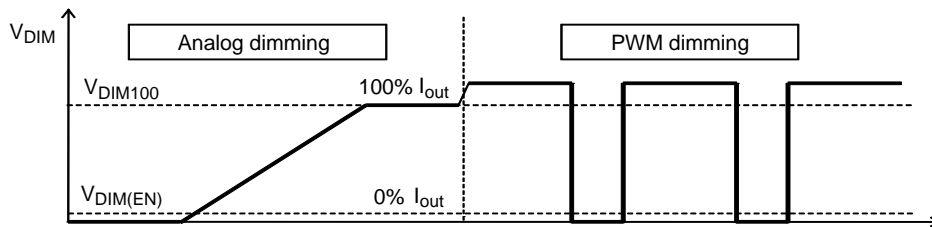

Figure 61. Pin DIM Chronograms

Note:

- If a PWM voltage with a high state value  $< V_{DIM100}$  is applied to the DIM pin, the product will still be in PWM dimming mode, but the reference voltage will be decreased according to  $V_{DIM}$ . This allows increased dynamic range on the dimming control pin.
- **Thermal Foldback and dimming:** if the IC is in a dimming state and the thermal foldback (TF) is activated, the output current is further reduced to a value equal to  $Dimming * TF$ .



## NCL30082

### V<sub>CC</sub> Over Voltage Protection (Open LED Protection)

If no output load is connected to the LED power supply, the controller must be able to safely limit the output voltage excursion.

In the NCL30082, when the V<sub>CC</sub> voltage reaches the V<sub>CC(OVP)</sub> threshold, the controller stops the DRV pulses and the 4-s timer starts counting. The IC re-start pulsing after the 4-s timer has elapsed and when V<sub>CC</sub> ≥ V<sub>CC(on)</sub>.

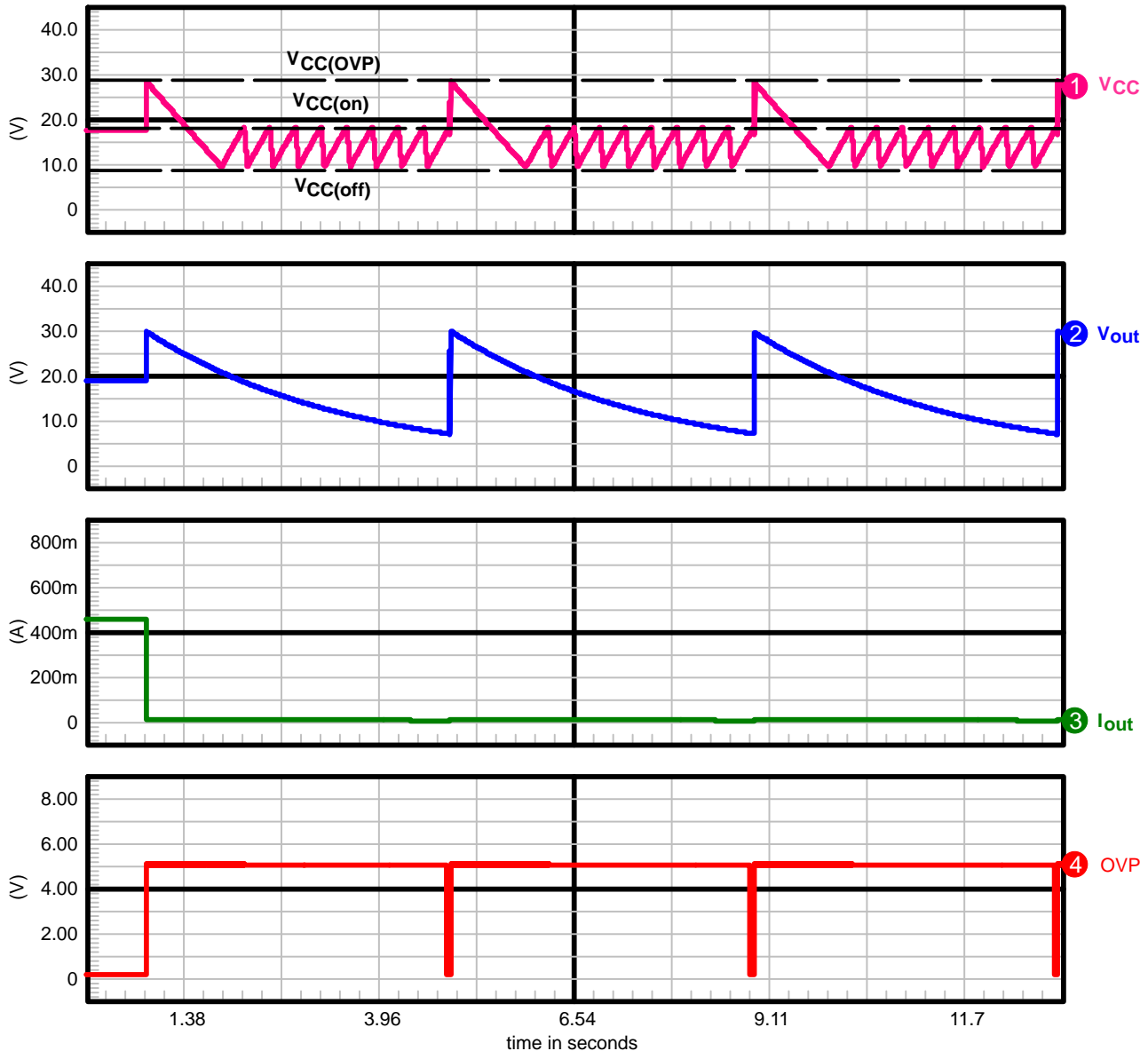

Figure 62. Open LED Protection Chronograms

### Valley Lockout

Quasi-square wave resonant systems have a wide switching frequency excursion. The switching frequency increases when the output load decreases or when the input voltage increases. The switching frequency of such systems must be limited.

The NCL30082 changes the valley as the input voltage increases and as the output current set-point is varied (dimming and thermal fold-back). This limits the switching frequency excursion. Once a valley is selected, the controller stays locked in the valley until the input voltage

or the output current set-point varies significantly. This avoids valley jumping and the inherent noise caused by this phenomenon.

The input voltage is sensed by the VIN pin (line range detection in Figure 63). The internal logic selects the operating valley according to VIN pin voltage, SD pin voltage and DIM pin voltage.

By default, when the output current is not dimmed, the controller operates in the first valley at low line and in the second valley at high line.

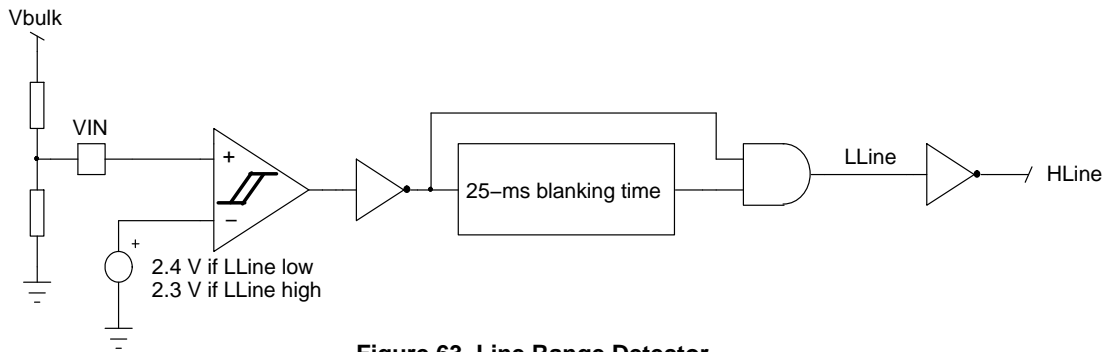

Figure 63. Line Range Detector

Table 4. VALLEY SELECTION

$I_{out}$ value at which the controller changes valley ( $I_{out}$ decreasing)	VIN pin voltage for valley change				$I_{out}$ value at which the controller changes valley ( $I_{out}$ increasing)
	0	-LL-	2.3 V	-HL-	
$I_{out}$ decreases 	100%	1 <sup>st</sup>		2 <sup>nd</sup>	100%
	75%		2 <sup>nd</sup>		78%
	50%		4 <sup>th</sup>		53%
	30%		7 <sup>th</sup>		33%
	15%		11 <sup>th</sup>		20%
	6%		13 <sup>th</sup>		8%
	0%				0%
	0	-LL-	2.4 V	-HL-	5 V
	$V_{VIN}$ increases 				
	VIN pin voltage for valley change				

**Zero Crossing Detection Block**

The ZCD pin allows detecting when the drain–source voltage of the power MOSFET reaches a valley.

A valley is detected when the voltage on pin 1 crosses below the  $V_{ZCD(THD)}$  internal threshold.

At startup or in case of extremely damped free oscillations, the ZCD comparator may not be able to detect

the valleys. To avoid such a situation, the NCL30082 features a Time–Out circuit that generates pulses if the voltage on ZCD pin stays below the  $V_{ZCD(THD)}$  threshold for 6.5  $\mu$ s.

The time–out also acts as a substitute clock for the valley detection and simulates a missing valley in case of too damped free oscillations.

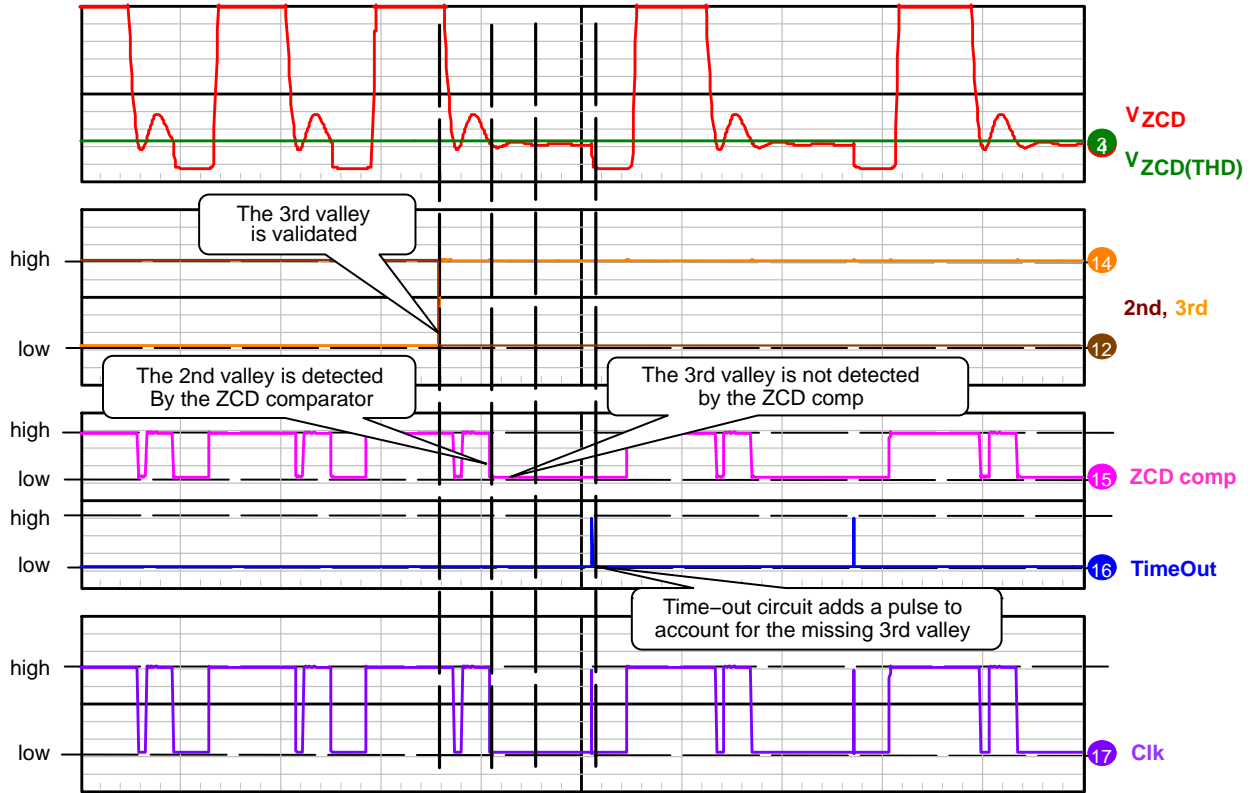

**Figure 64. Time–out Chronograms**

Normally with this type of time–out function, in the event the ZCD pin or the auxiliary winding is shorted, the controller could continue switching leading to improper regulation of the LED current. Moreover during an output short circuit, the controller will strive to maintain constant current operation.

To avoid these scenarios, a protection circuit consisting of a comparator and secondary timer starts counting when the ZCD voltage is below the  $V_{ZCD(short)}$  threshold. If this timer reaches 90 ms, the controller detects a fault and shutdown. The auto–restart version (B, B1, B2, D suffix) waits 4 seconds, then the controller restarts switching. In the latched version (A suffix), the controller is latched as long as  $V_{CC}$  stays above the  $V_{CC(reset)}$  threshold.

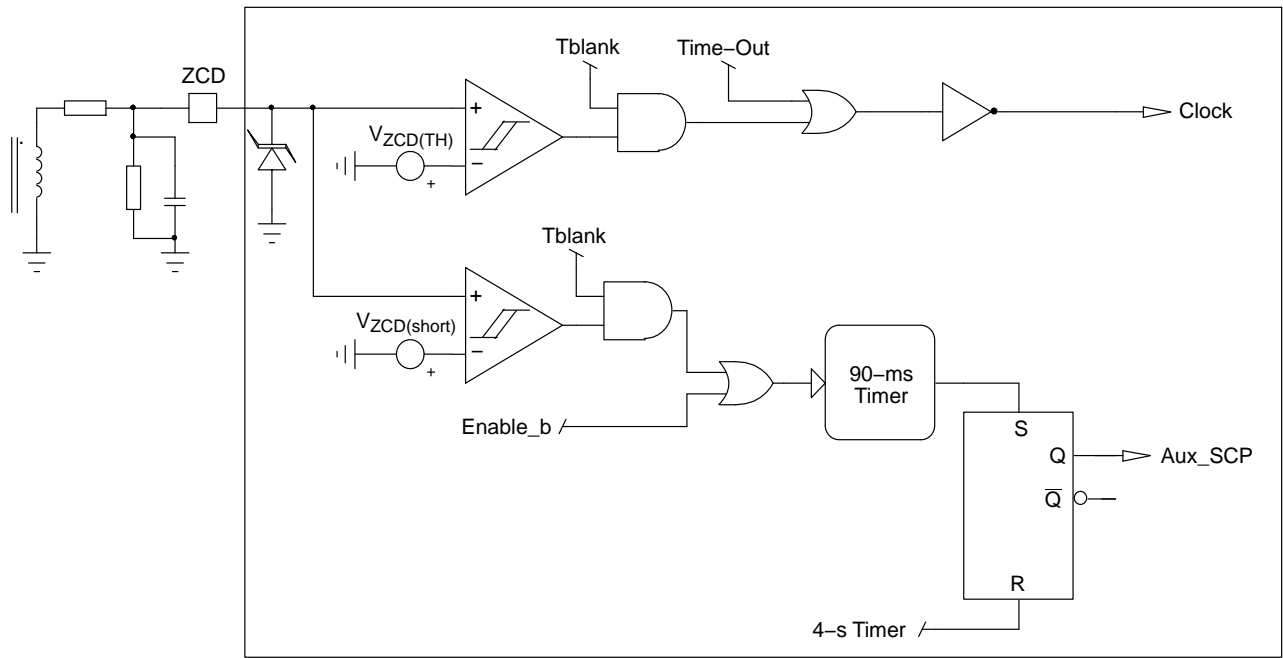

Figure 65. ZCD Block Schematic

**Line Feed-Forward**

Because of the propagation delays, the MOSFET is not turned-off immediately when the current set-point is reached. As a result, the primary peak current is higher than expected and the output current increases. To compensate the peak current increase brought by the propagation delay, a positive voltage proportional to the line voltage is added on the current sense signal. The amount of offset voltage can be adjusted using the R<sub>CS</sub> resistor as shown in Figure 66.

$$V_{CS(\text{offset})} = K_{LFF} V_{\text{pin}} V_{\text{IN}} R_{\text{CS}} \quad (\text{eq. 5})$$

The offset voltage is applied only during the MOSFET on-time.

This offset voltage is removed at light load during dimming when the output current drops below 15% of the programmed output current.

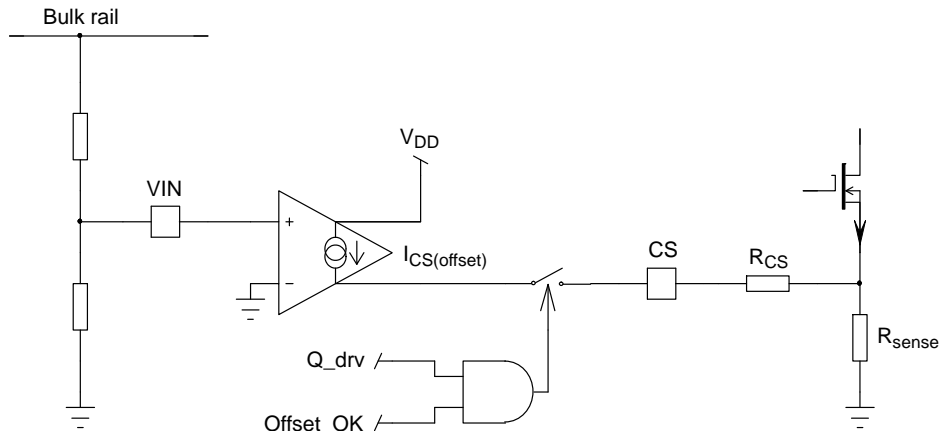

Figure 66. Line Feed-Forward Schematic

**Brown-out**

In order to protect the supply against a very low input voltage, the NCL30082 features a brown-out circuit with a fixed ON/OFF threshold. The controller is allowed to start if a voltage higher than 1 V is applied to the VIN pin and shuts-down if the VIN pin voltage decreases and stays

below 0.9 V for 50 ms nominal. For the NCL30082D, the blanking time is reduced to 15 ms. Exiting a brown-out condition overrides the hiccup on  $V_{CC}$  ( $V_{CC}$  does not wait to reach  $V_{CC(off)}$ ) and the IC immediately goes into startup mode ( $I_{CC} = I_{CC(start)}$ ).

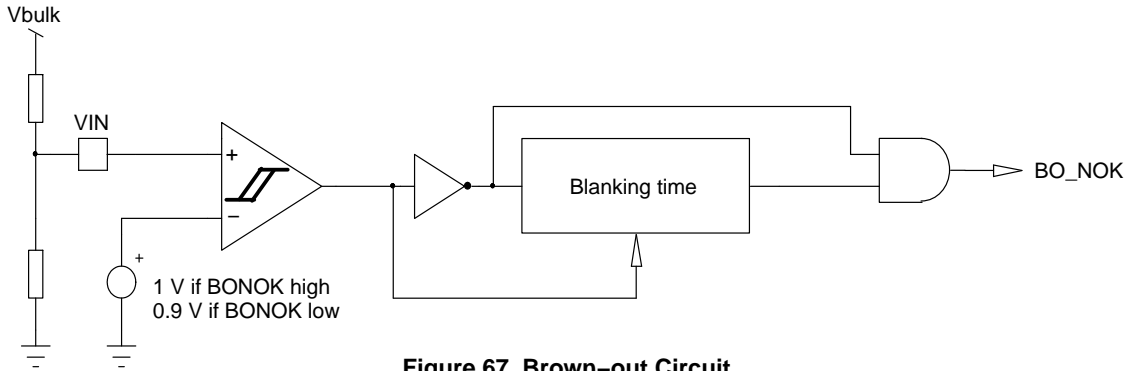

Figure 67. Brown-out Circuit

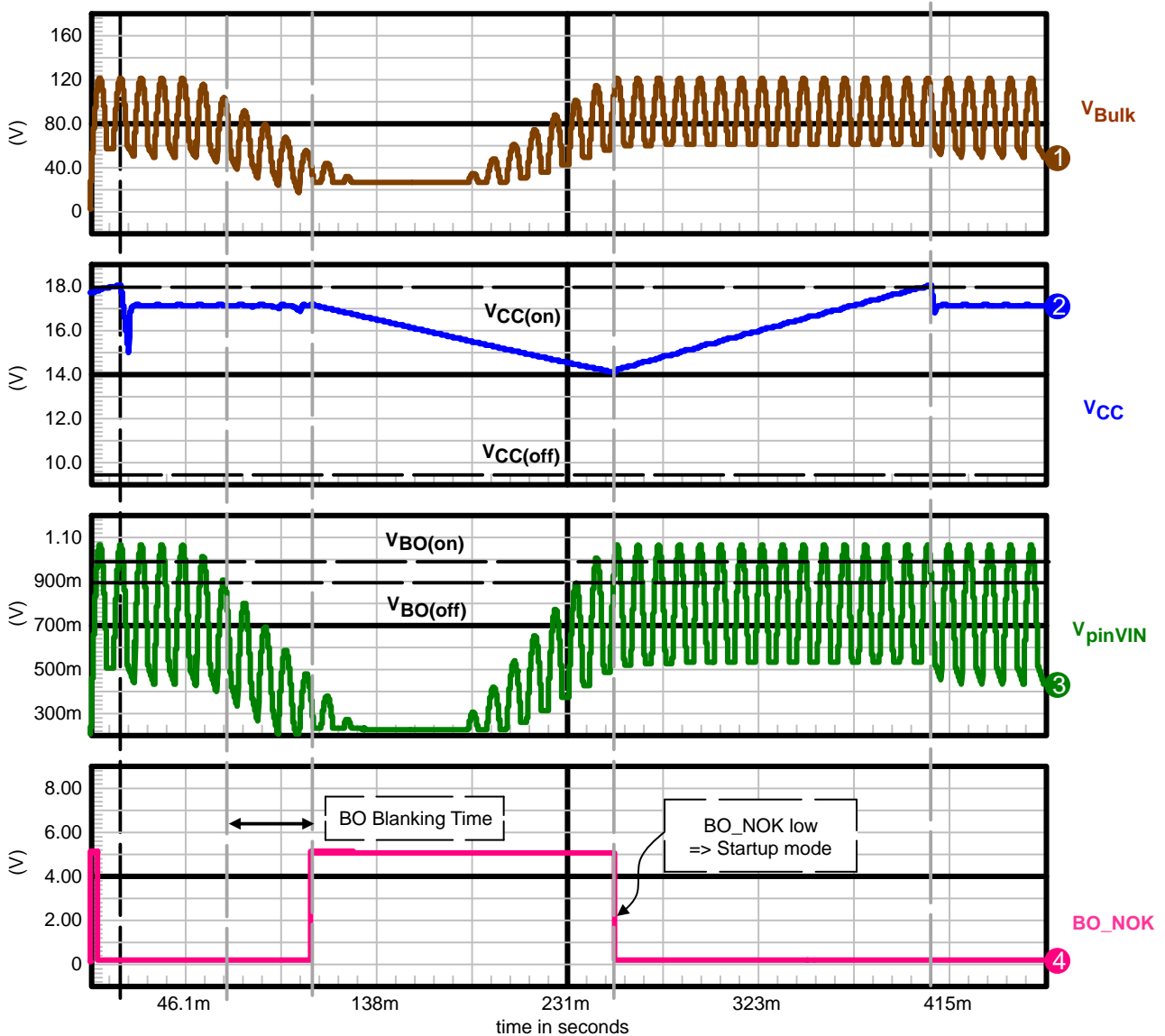
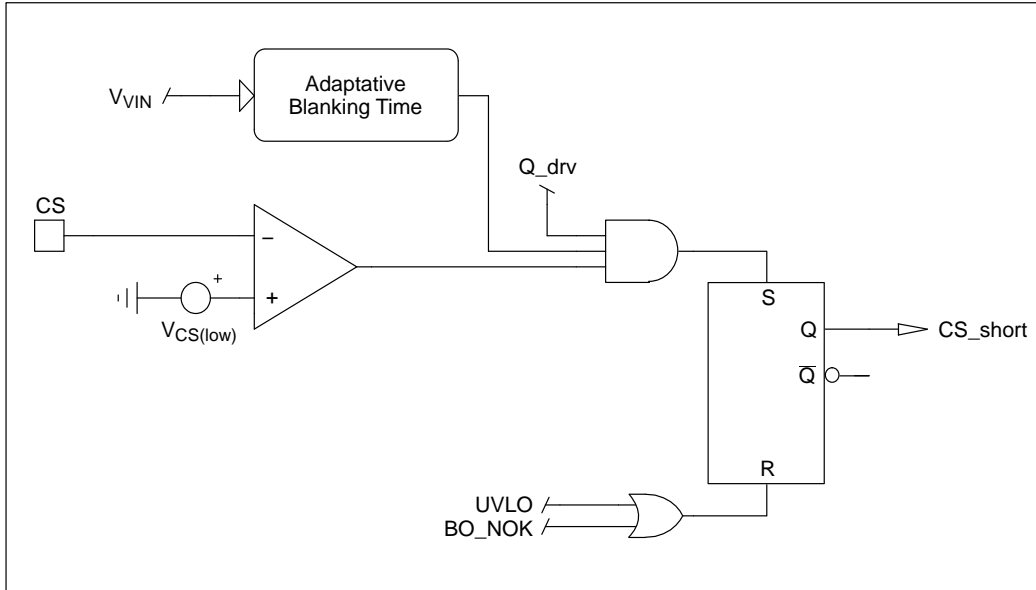

Figure 68. Brown-Out Chronograms (Valley Fill circuit is used)

**CS Pin Short Circuit Protection**

Normally, if the CS pin or the sense resistor is shorted to ground, the Driver will not be able to turn off, leading to potential damage of the power supply. To avoid this, the versions A, B, B1, B2, B3 and D feature a circuit to protect the power supply against a short circuit of the CS pin. When

the MOSFET is on, if the CS voltage stays below  $V_{CS(low)}$  after the adaptive blanking timer has elapsed, the controller shuts down and will attempt to restart on the next VCC hiccup. In the NCL30082B1, this protection is disabled.



**Figure 69. CS Pin Short Circuit Protection Schematic**

**Fault Management**

OFF Mode

The circuit turns off whenever a major condition prevents it from operating:

- Incorrect feeding of the circuit: “UVLO high”. The UVLO signal becomes high when  $V_{CC}$  drops below  $V_{CC(off)}$  and remains high until  $V_{CC}$  exceeds  $V_{CC(on)}$ .
- OTP
- $V_{CC}$  OVP
- OVP2 (additional OVP provided by SD pin)
- Output diode short circuit protection: “WOD\_SCP high”
- Output / Auxiliary winding Short circuit protection: “Aux\_SCP high”
- Die over temperature (TSD)
- Brown-Out: “BO\_NOK” high
- Pin CS short circuited to GND: “CS\_short high”

In this mode, the DRV pulses are stopped. The VCC voltage decrease through the controller own consumption ( $I_{CC1}$ ).

For the output diode short circuit protection, the CS pin short circuit protection, the output / aux. winding short circuit protection and the OVP2, the controller waits 4 seconds (auto-recovery timer) and then initiates a startup sequence ( $V_{CC} \geq V_{CC(on)}$ ) before re-starting switching.

Latch Mode

This mode is activated by the output diode short-circuit protection (WOD\_SCP), the OTP and the Aux-SCP in **version A only**.

In this mode, the DRV pulses are stopped and the controller is latched. There are hiccups on  $V_{CC}$ .

The circuit un-latches when  $V_{CC} < V_{CC(reset)}$ .

# NCL30082

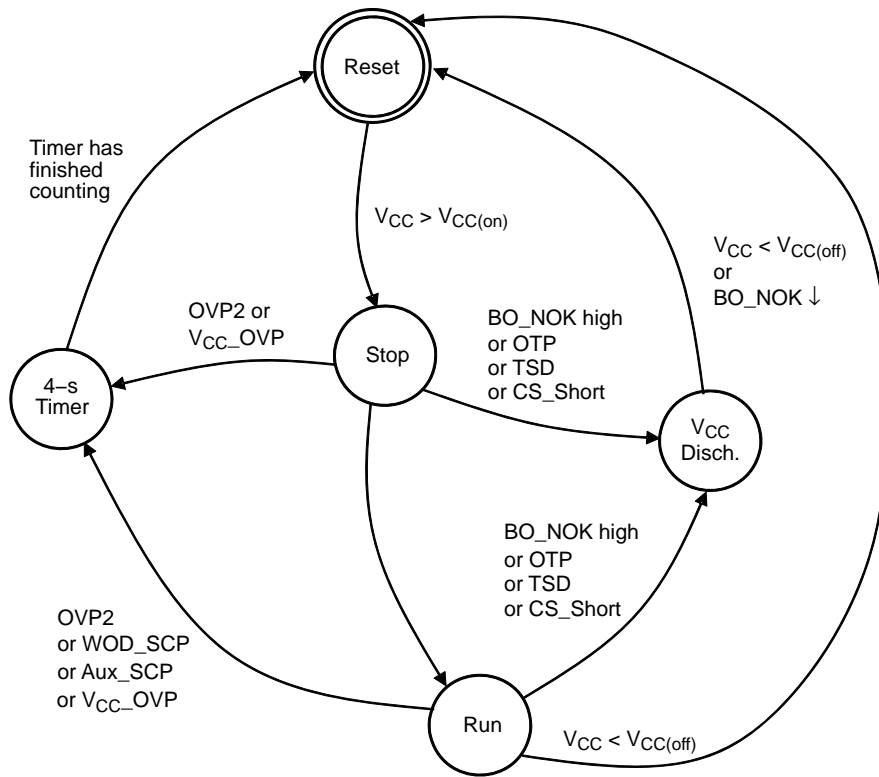

<u>With states:</u> Reset	→	Controller is reset, $I_{CC} = I_{CC(start)}$
Stop	→	Controller is ON, DRV is not switching, $t_{OTP(start)}$ has elapsed
Run	→	Normal switching
V <sub>CC</sub> Disch.	→	No switching, $I_{CC} = I_{CC1}$ , waiting for V <sub>CC</sub> to decrease to V <sub>CC(off)</sub>
4-s Timer	→	the auto-recovery timer is counting, V <sub>CC</sub> is ramping up and down between V <sub>CC(on)</sub> and V <sub>CC(off)</sub>

Note: For the NCL30082B1, the CS pin short circuit Protection is disabled

**Figure 70. State Diagram for B, B1, B2, B3 and D Version Faults**

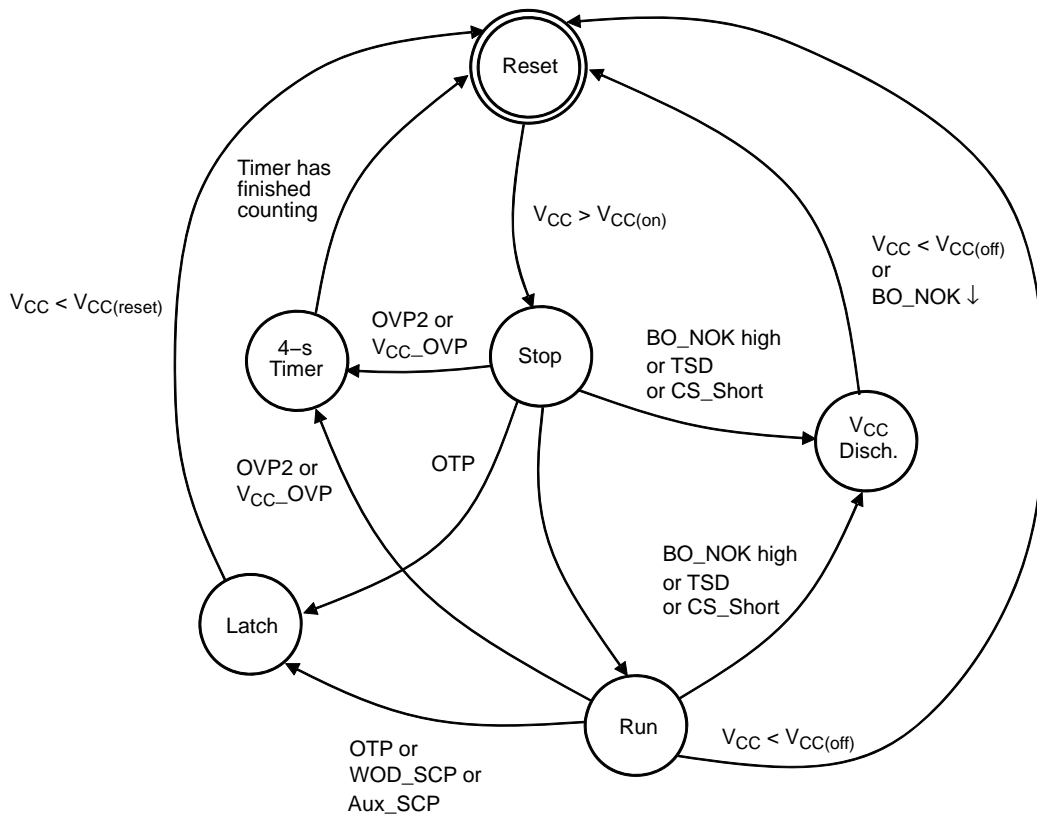

<b>With states:</b> Reset	→ Controller is reset, $I_{CC} = I_{CC(start)}$
Stop	→ Controller is ON, DRV is not switching, $t_{OTP(start)}$ has elapsed
Run	→ Normal switching
V <sub>CC</sub> Disch.	→ No switching, $I_{CC} = I_{CC1}$ , waiting for V <sub>CC</sub> to decrease to V <sub>CC(off)</sub>
4-s Timer	→ the auto-recovery timer is counting, V <sub>CC</sub> is ramping up and down between V <sub>CC(on)</sub> and V <sub>CC(off)</sub>
Latch	→ Controller is latched off, V <sub>CC</sub> is ramping up and down between V <sub>CC(on)</sub> and V <sub>CC(off)</sub> , only V <sub>CC(reset)</sub> can release the latch.

Figure 71. State Diagram for A Version Faults



# NCL30082

## OPTIONS

Controller	Output SCP	Winding/ Output Diode SCP	Over Temperature Protection	CS Pin Short Protection	V <sub>REF</sub>	ZCD Blanking	Brown-Out blanking	Thermal Foldback
NCL30082A	Latched	Latched	Latched	Yes	250 mV	3 $\mu$ s	50 ms	Smooth output current decrease
NCL30082B	Auto-recovery	Auto-recovery	Auto-recovery	Yes	250 mV	3 $\mu$ s	50 ms	Smooth output current decrease
NCL30082B1	Auto-recovery	Auto-recovery	Auto-recovery	No	250 mV	3 $\mu$ s	50 ms	Smooth output current decrease
NCL30082B2	Auto-recovery	Auto-recovery	Auto-recovery	Yes	250 mV	1.5 $\mu$ s	50 ms	Smooth output current decrease
NCL30082B3	Auto-recovery	Auto-recovery	Auto-recovery	Yes	333 mV	1.5 $\mu$ s	50 ms	Smooth output current decrease
NCL30082B4	Auto-recovery	Auto-recovery	Auto-recovery	No	250 mV	1.5 $\mu$ s	50 ms	Smooth output current decrease
NCL30082B5	Auto-recovery	Auto-recovery	Auto-recovery	No	333 mV	1.5 $\mu$ s	50 ms	Smooth output current decrease
NCL30082D	Auto-recovery	Auto-recovery	Auto-recovery	Yes	500 mV	3 $\mu$ s	15 ms	Steep output current decrease

## ORDERING INFORMATION

Device	Package Marking	Package Type	Shipping <sup>†</sup>
NCL30082ADMR2G	AAC	Micro8 (Pb-Free, Halide-Free)	4000 / Tape & Reel
NCL30082BDMR2G	AAD	Micro8 (Pb-Free, Halide-Free)	4000 / Tape & Reel
NCL30082B1DMR2G	AAH	Micro8 (Pb-Free, Halide-Free)	4000 / Tape & Reel
NCL30082BDR2G	L30082B	SOIC-8 (Pb-Free)	2500 / Tape & Reel
NCL30082B1DR2G	L30082B1	SOIC-8 (Pb-Free)	2500 / Tape & Reel
NCL30082B2DR2G	L30082B2	SOIC-8 (Pb-Free)	2500 / Tape & Reel
NCL30082B3DR2G	L30082B3	SOIC-8 (Pb-Free)	2500 / Tape & Reel
NCL30082B4DR2G	L30082B4	SOIC-8 (Pb-Free)	2500 / Tape & Reel
NCL30082B5DR2G	L30082B5	SOIC-8 (Pb-Free)	2500 / Tape & Reel
NCL30082DDR2G	L30082D	SOIC-8 (Pb-Free)	2500 / Tape & Reel

<sup>†</sup>For information on tape and reel specifications, including part orientation and tape sizes, please refer to our Tape and Reel Packaging Specifications Brochure, BRD8011/D.

# NCL30082

## PACKAGE DIMENSIONS

**Micro8™**  
CASE 846A-02  
ISSUE J

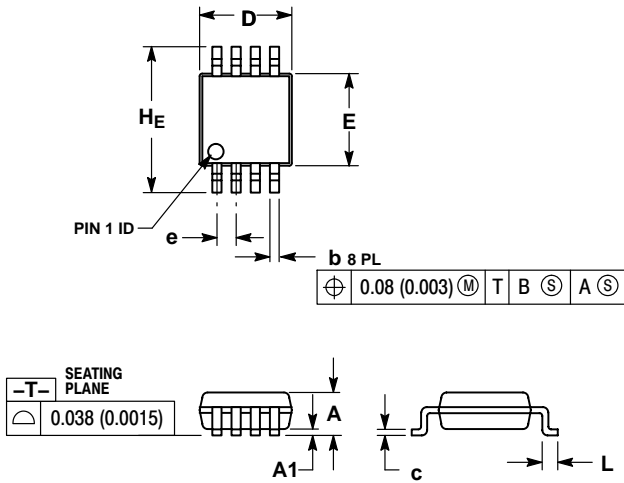

**NOTES:**

1. DIMENSIONING AND TOLERANCING PER ANSI Y14.5M, 1982.
2. CONTROLLING DIMENSION: MILLIMETER.
3. DIMENSION A DOES NOT INCLUDE MOLD FLASH, PROTRUSIONS OR GATE BURRS. MOLD FLASH, PROTRUSIONS OR GATE BURRS SHALL NOT EXCEED 0.15 (0.006) PER SIDE.
4. DIMENSION B DOES NOT INCLUDE INTERLEAD FLASH OR PROTRUSION. INTERLEAD FLASH OR PROTRUSION SHALL NOT EXCEED 0.25 (0.010) PER SIDE.
5. 846A-01 OBSOLETE, NEW STANDARD 846A-02.

DIM	MILLIMETERS			INCHES		
	MIN	NOM	MAX	MIN	NOM	MAX
A	---	---	1.10	---	---	0.043
A1	0.05	0.08	0.15	0.002	0.003	0.006
b	0.25	0.33	0.40	0.010	0.013	0.016
c	0.13	0.18	0.23	0.005	0.007	0.009
D	2.90	3.00	3.10	0.114	0.118	0.122
E	2.90	3.00	3.10	0.114	0.118	0.122
e	0.65 BSC			0.026 BSC		
L	0.40	0.55	0.70	0.016	0.021	0.028
HE	4.75	4.90	5.05	0.187	0.193	0.199

### RECOMMENDED SOLDERING FOOTPRINT\*

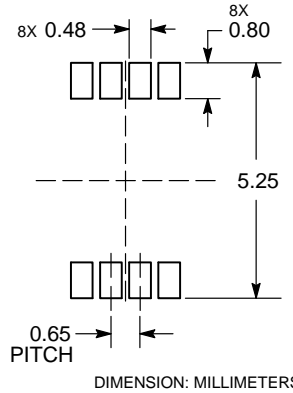

\*For additional information on our Pb-Free strategy and soldering details, please download the ON Semiconductor Soldering and Mounting Techniques Reference Manual, SOLDERRM/D.

# NCL30082

## PACKAGE DIMENSIONS

### SOIC-8 NB CASE 751-07 ISSUE AK

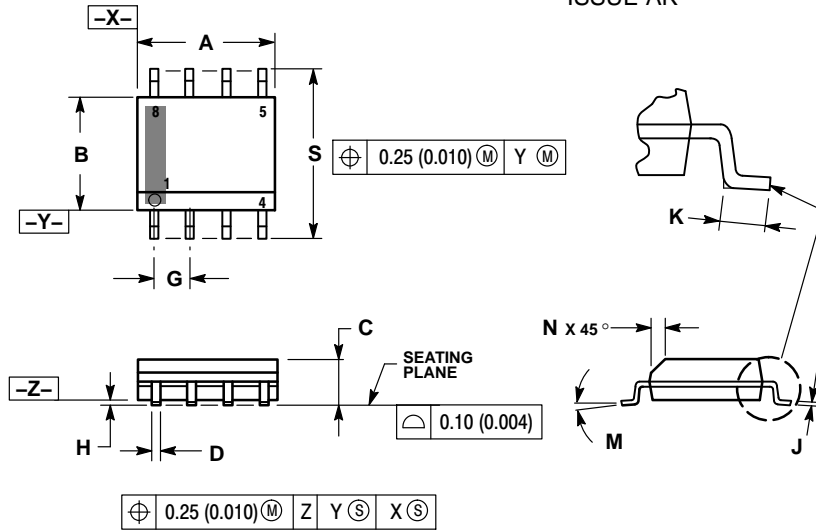

#### NOTES:

1. DIMENSIONING AND TOLERANCING PER ANSI Y14.5M, 1982.
2. CONTROLLING DIMENSION: MILLIMETER.
3. DIMENSION A AND B DO NOT INCLUDE MOLD PROTRUSION.
4. MAXIMUM MOLD PROTRUSION 0.15 (0.006) PER SIDE.
5. DIMENSION D DOES NOT INCLUDE DAMBAR PROTRUSION. ALLOWABLE DAMBAR PROTRUSION SHALL BE 0.127 (0.005) TOTAL IN EXCESS OF THE D DIMENSION AT MAXIMUM MATERIAL CONDITION.
6. 751-01 THRU 751-06 ARE OBSOLETE. NEW STANDARD IS 751-07.

DIM	MILLIMETERS		INCHES	
	MIN	MAX	MIN	MAX
A	4.80	5.00	0.189	0.197
B	3.80	4.00	0.150	0.157
C	1.35	1.75	0.053	0.069
D	0.33	0.51	0.013	0.020
G	1.27 BSC		0.050 BSC	
H	0.10	0.25	0.004	0.010
J	0.19	0.25	0.007	0.010
K	0.40	1.27	0.016	0.050
M	0° - 8°		0° - 8°	
N	0.25	0.50	0.010	0.020
S	5.80	6.20	0.228	0.244

#### SOLDERING FOOTPRINT\*

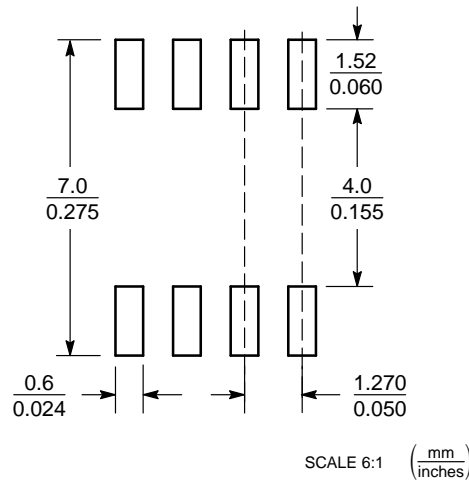

\*For additional information on our Pb-Free strategy and soldering details, please download the ON Semiconductor Soldering and Mounting Techniques Reference Manual, SOLDERRM/D.

ON Semiconductor and the are registered trademarks of Semiconductor Components Industries, LLC (SCILLC) or its subsidiaries in the United States and/or other countries. SCILLC owns the rights to a number of patents, trademarks, copyrights, trade secrets, and other intellectual property. A listing of SCILLC's product/patent coverage may be accessed at [www.onsemi.com/site/pdf/Patent-Marking.pdf](http://www.onsemi.com/site/pdf/Patent-Marking.pdf). SCILLC reserves the right to make changes without further notice to any products herein. SCILLC makes no warranty, representation or guarantee regarding the suitability of its products for any particular purpose, nor does SCILLC assume any liability arising out of the application or use of any product or circuit, and specifically disclaims any and all liability, including without limitation special, consequential or incidental damages. "Typical" parameters which may be provided in SCILLC data sheets and/or specifications can and do vary in different applications and actual performance may vary over time. All operating parameters, including "Typicals" must be validated for each customer application by customer's technical experts. SCILLC does not convey any license under its patent rights nor the rights of others. SCILLC products are not designed, intended, or authorized for use as components in systems intended for surgical implant into the body, or other applications intended to support or sustain life, or for any other application in which the failure of the SCILLC product could create a situation where personal injury or death may occur. Should Buyer purchase or use SCILLC products for any such unintended or unauthorized application, Buyer shall indemnify and hold SCILLC and its officers, employees, subsidiaries, affiliates, and distributors harmless against all claims, costs, damages, and expenses, and reasonable attorney fees arising out of, directly or indirectly, any claim of personal injury or death associated with such unintended or unauthorized use, even if such claim alleges that SCILLC was negligent regarding the design or manufacture of the part. SCILLC is an Equal Opportunity/Affirmative Action Employer. This literature is subject to all applicable copyright laws and is not for resale in any manner.

#### PUBLICATION ORDERING INFORMATION

##### LITERATURE FULFILLMENT:

Literature Distribution Center for ON Semiconductor  
P.O. Box 5163, Denver, Colorado 80217 USA  
Phone: 303-675-2175 or 800-344-3860 Toll Free USA/Canada  
Fax: 303-675-2176 or 800-344-3867 Toll Free USA/Canada  
Email: [orderlit@onsemi.com](mailto:orderlit@onsemi.com)

**N. American Technical Support:** 800-282-9855 Toll Free  
USA/Canada  
**Europe, Middle East and Africa Technical Support:**  
Phone: 421 33 790 2910  
**Japan Customer Focus Center**  
Phone: 81-3-5817-1050

**ON Semiconductor Website:** [www.onsemi.com](http://www.onsemi.com)

**Order Literature:** <http://www.onsemi.com/orderlit>

For additional information, please contact your local Sales Representative

## Данный компонент на территории Российской Федерации

### Вы можете приобрести в компании MosChip.

Для оперативного оформления запроса Вам необходимо перейти по данной ссылке:

<http://moschip.ru/get-element>

Вы можете разместить у нас заказ для любого Вашего проекта, будь то серийное производство или разработка единичного прибора.

В нашем ассортименте представлены ведущие мировые производители активных и пассивных электронных компонентов.

Нашей специализацией является поставка электронной компонентной базы двойного назначения, продукции таких производителей как XILINX, Intel (ex.ALTERA), Vicor, Microchip, Texas Instruments, Analog Devices, Mini-Circuits, Amphenol, Glenair.

Сотрудничество с глобальными дистрибьюторами электронных компонентов, предоставляет возможность заказывать и получать с международных складов практически любой перечень компонентов в оптимальные для Вас сроки.

На всех этапах разработки и производства наши партнеры могут получить квалифицированную поддержку опытных инженеров.

Система менеджмента качества компании отвечает требованиям в соответствии с ГОСТ Р ИСО 9001, ГОСТ РВ 0015-002 и ЭС РД 009

### Офис по работе с юридическими лицами:

105318, г.Москва, ул.Щербаковская д.3, офис 1107, 1118, ДЦ «Щербаковский»

Телефон: +7 495 668-12-70 (многоканальный)

Факс: +7 495 668-12-70 (доб.304)

E-mail: [info@moschip.ru](mailto:info@moschip.ru)

Skype отдела продаж:

moschip.ru

moschip.ru\_4

moschip.ru\_6

moschip.ru\_9