

WaveLink® Differential Probe System (4 GHz – 6 GHz)

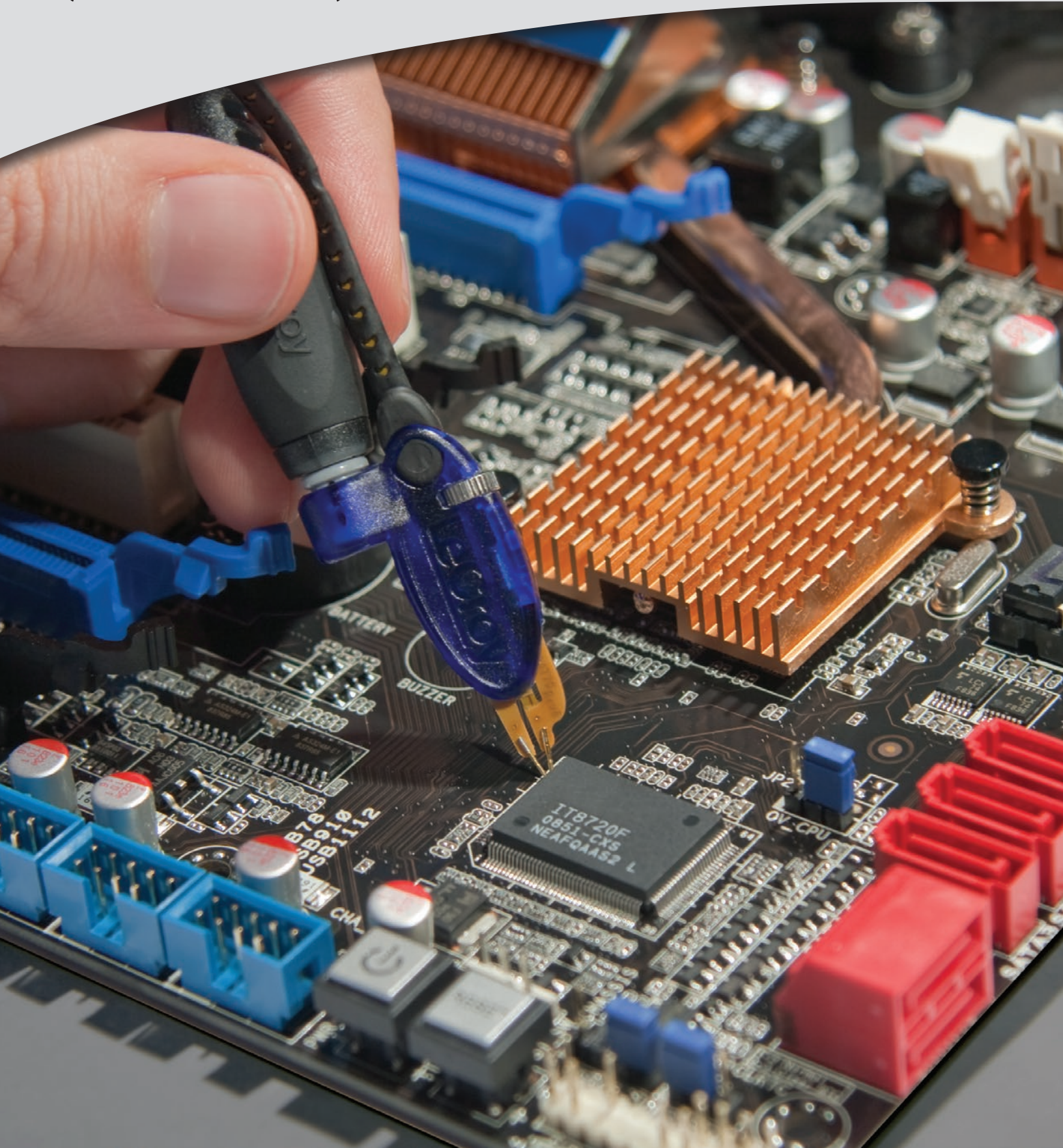

EXCEPTIONAL WAVEFORM FIDELITY

Key Features

- 4 GHz or 6 GHz models
- Up to 5 Vpk-pk dynamic range with low noise
- ± 3 V offset range
- Deluxe soft carrying case
- Wide variety of tips and leads
 - Solder-In Lead
 - Positioner (Browser) Tip
 - Adjustable (Browser) Tip
 - Quick Connect Lead
 - Square Pin Lead
 - HiTemp Solder-In Lead
- Ideal for DDR2, DDR3, LPDDR2



The WaveLink 4-6 GHz differential probe series provides the widest range of tips with the highest input dynamic range and a large offset capability.

WaveLink®

WaveLink® probes provide industry leading technology for wideband signal connection to test instruments. The first differential probes to employ SiGe technology, they deliver full system bandwidth when used with WaveRunner®, WavePro®, WaveMaster®, DDA and SDA oscilloscopes up to 6 GHz.

WaveLink probes:

- Maintain good loading characteristics across the frequency span
- Optimize for gain, noise and bandwidth for optimal performance
- Offer broad range of dynamic range and noise over gain settings by incorporating automatic probe attenuation changes

WaveLink is the first differential probe to use a unique calibration process to achieve superb waveform fidelity for routine voltage measurements.

Calibration coefficients "fine tune" the frequency response of each WaveLink probe and are individually determined during factory calibration and programmed into the probe. The SDA, DDA, WaveMaster, WaveRunner, or WavePro Series oscilloscopes read this data and use it to digitally compensate the entire system response for superior fidelity.

Signal Fidelity

WaveLink probes virtually eliminate distortion when measuring signals. This benefit is particularly useful in eye pattern measurements, now routine for systems using fast serial parallel data bus architecture.

All WaveLink probes offer:

- Superior loading characteristics
- Precise frequency response with outstanding fidelity for high-speed signals

Both low loading and frequency response flatness are needed to ensure the signal fidelity required to measure performance accurately.

Tip Flexibility

WaveLink test leads make connecting to test points very simple. The wide variety of tips offered provide confidence that the most challenging test points can be probed.

The Solder-In, PT Browser, Quick Connect, and Square Pin lead sets are rated for multiple insertions and offer field replacement tips for user value, while giving the best signal fidelity as a system to the test points.

An assortment of hands-free probe holders ease the challenge of connecting multiple leads to a board.

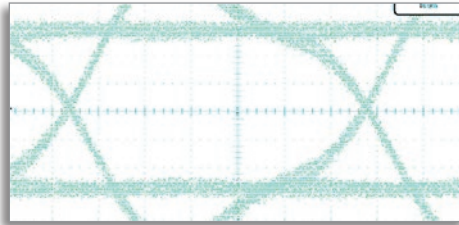

3.125 Gb/s XAUI signal measured with system using a probe with good frequency flatness, but excessive loading.

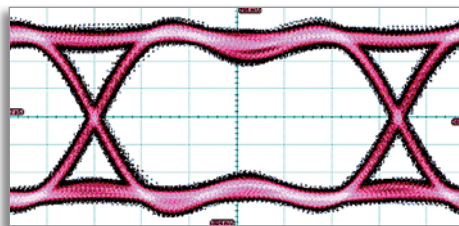

Same signal measured with WaveLink D610. Low loading and flat frequency response combine to maintain the fidelity in the eye pattern.

Serial Data

Serial data signals all vary in signal characteristics and connection type. WaveLink features a wide dynamic range and offset to accommodate a wide input voltage range. WaveLink's automatic probe attenuation network allows an input voltage up to $\pm 5 V_{p-p}$ with the lowest system noise for measuring small signals.

Single-ended Measurements

WaveLink differential probes offer enhanced capabilities to make single-ended measurements with low loading and improved CMRR. Single-ended measurements on DDR signals with D6x0/D4x0 probes utilize $\pm 3 V$ offset range to return a more accurate and repeatable measurement.

Probe Positioners

Multiple probe connections are often necessary to properly debug board level problems. WaveLink probes afford a variety of hands free positioners to offer stable and accurate probe tip placement to make perfect contact without the worry of hand probing errors.

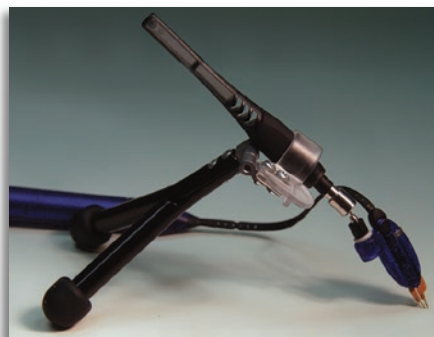

FreeHand with PT Tip and Wand.



XYZ Positioner with PT Tip.

FLEXIBLE INTERCONNECTION OPTIONS

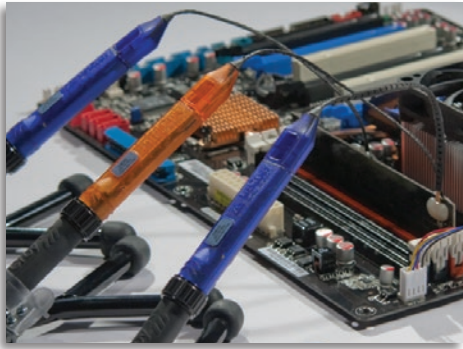

WaveLink Differential Amplifier Small Tip Modules

The D610/D410 and D620/D420 probes provide superior electrical characteristics to provide the best signal fidelity.

- Lowest noise performance for accurate measurements
- High DC impedance
- Low loading for minimum signal disturbance
- High sensitivity for probing low voltage signals

The D6x0/D4x0 probes are superior to single-ended probes for measuring ground referenced signals. Placing the probe will not alter local ground variation, and the measured signal won't be distorted by this variation.

Best-in-class mechanical design for optimum utility:

- Small tip, high bandwidth differential probe
- Five interconnect configurations for flexibility
- Very small form factor for accessing tight spaces

Each of the interchangeable leads is a thin, highly flexible 145 mm (5.7") long lead connecting the tip and the D610/D620 and D410/D420 probe tip module.

Five Different Tips for Interconnect Flexibility

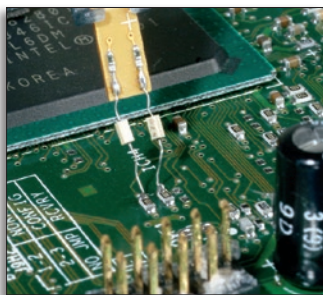

A. Solder-In Lead (SI)

The Solder-In interconnect lead features the smallest physical tip size of any high bandwidth differential probe and the highest level of electrical performance. Two very small damping resistors are directly soldered into the connect points providing a reliable, intermittence-free electrical connection. The resistors have highly flexible leads allowing connection to input points with a wide range of input spacing.

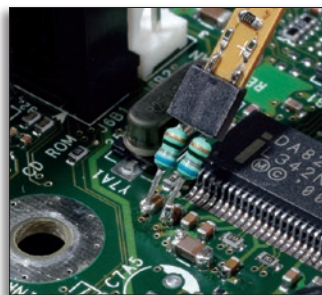

B. Quick Connect (QC)

The Quick Connect interconnect lead enables you to quickly move the probe between multiple test points on the test circuit. Just solder a pair of leaded damping resistors at each location where interconnection is required. A small connector mounted on the probe tip plugs into the damping resistors, letting you quickly move between sets of test points.

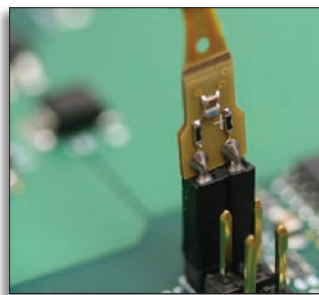

C. Square Pin (SP)

Many applications, such as IC characterization boards, use standard 0.025" square pins for interconnect. The Square Pin interconnect lead directly mates with a pair of 0.025" (0.635 mm) square pins that are mounted on standard 0.100" (2.54 mm) centers.

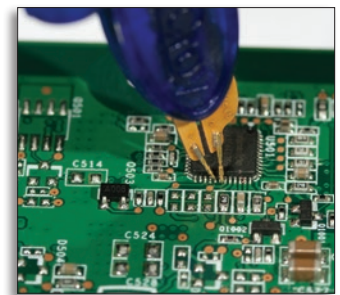

D. Positioner Tip (PT)

The PT positioner tips provides spring loaded leads to allow for easy probing. The adjustable wheel allows for precise probing, allowing a spread up to 0.14". The small form factor provides a convenient grip for hand probing, or use the wand or XYZ positioner for more precise placement.

BROWSER OPTIONS

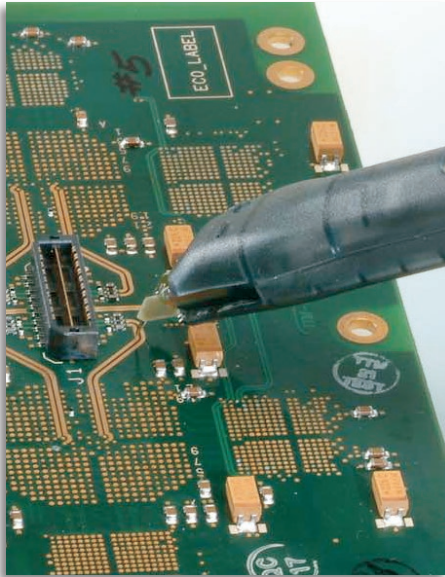

WaveLink Differential Amplifier Modules with Adjustable Tip

WaveLink adjustable tip probes are designed to provide an optimum mechanical connection for signal measurement.

- Built-in thumbwheel for precise positioning of tip – stays put after adjustment
- Maintains sharp points for good contact
- Tips made of “NiTiNOL,” a super-elastic nickel-titanium alloy
- Flexes as you apply pressure
- Consistently returns to original form

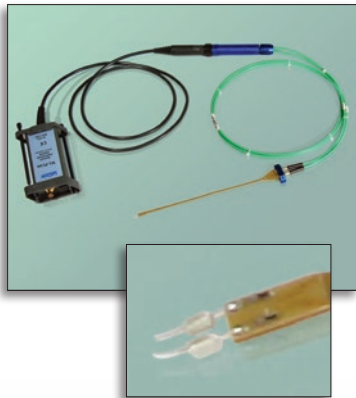

E. High Temperature (HiTemp) Cables and Solder-In Lead

The 90 cm HiTemp cables and Solder-In lead can be used for controlled situations where the differential amplifier module needs to be removed from the extreme temperature environment. Ideally suited for testing scenarios where the temperature can fluctuate from -40 °C to +105 °C.

PT Browser Tip Leads

The PT browser tip offers two options to pair with the appropriate probe body, providing the best scope/probe combination. The Dx10-PT and Dx20-PT browser tips are used with the D610/D620 for 6 GHz bandwidth probing needs, while a pairing with the D410/D420 amplifiers are rated to 4 GHz bandwidth. The PT positioner tip offers the

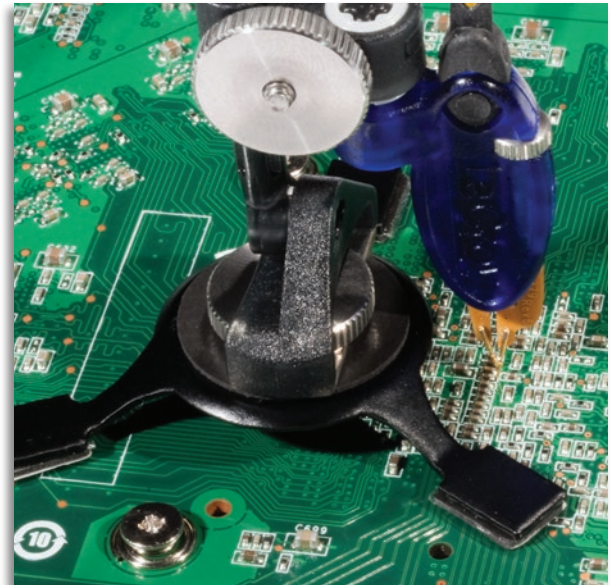

most flexibility in a browser probe to provide the best signal fidelity in an easy to use form factor. The PT browser tip offers superior noise and loading characteristics. The PT can be used with a variety of holders and accessories to allow for ease in hand browsing, or flexibility to use a positioner for hands free probing.

The small form factor makes probing small pitch ICs easy, with a tip spread of 0.14", adjustable with a thumb wheel. The probe tips offer a field replaceable spring tip (with a flex of 0.6 mm) to allow robust contact with DUT contacts.

COMPATIBILITY AND STANDARD ACCESSORIES CHART

Compatibility Chart

Platform/Cable Assembly

Differential Amplifiers

Tips/Leads

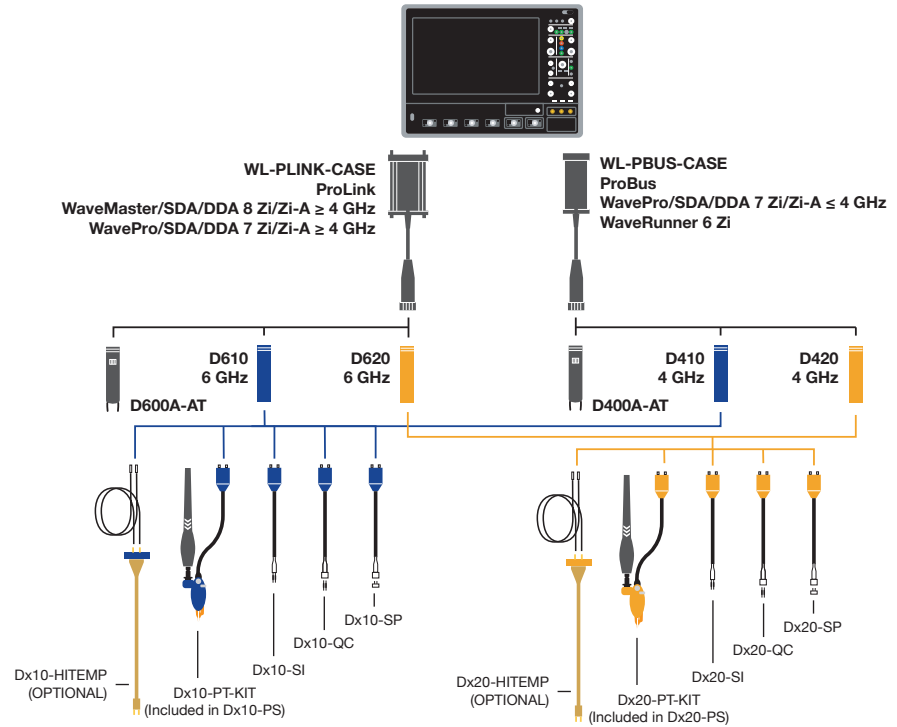

Accessories and Replacement Parts

	WL-PLINK-CASE WL-PBUS-CASE	D610/ D620	Dx10/ Dx20-PS	Dx10/ Dx20-PT-KIT	Dx10-SI-HiTemp/ Dx20-SI-HiTemp	Dx00A-AT	Replacement Part
Standard Accessories							
Amplifier System (includes items below with*)		1 each	1 each				D410, D420, D610 or D620
*Amplifier		1 each	1 each				
*Solder-In Lead Set (includes items below with**)		1 each	1 each				Dx10-SI, Dx20-SI
**Spare Damping Resistors for SI Tip		1 set of 5	1 set of 5				PKxx0-SI
**Tip Retaining Clip for SI & QC Leads		1 each	1 each				PK600ST-3
**Adhesive Tape		1 set	1 set				Dxx0-PT-TAPE
*Quick Connect Lead Set		1 each	1 each				Dx10-QC, Dx20-QC
*Damping Resistors for QC Tip (Included with QC Tip)		2 sets of 20	2 sets of 20				PKxx0-QC
*Ground Lead		1 each	1 each				PACC-LD005
*Ground Clip		1 each	1 each				PK006-4
*Square Pin Lead Set		1 each	1 each				Dx10-SP, Dx20-SP
*Instruction Manual		1 each	1 each			1 each	WL6G-OM-E
*Accessory Info Sheet & Quick Start Guide		1 each	1 each				921489-00 (Dx10), 921488-00(Dx20)
Positioner Tip with Accessories (kit includes items below with†)			1 each	1 each			RK-Dx10-PT-KIT, RK-Dx20-PT-KIT
†Positioner Tip Browser			1 each	1 each			Dx10-PT, Dx20-PT
†Replacement Pogo-pins for Dx10-PT/Dx20-PT			1 set	1 set			Dxx0-PT-TIPS
†Positioner Tip Probe Guides			1 set	1 set			Dxx0-PT-GUIDES
†XYZ Positioner			1 each	1 each			Dxx0-PT-XYZ-POSITIONER
†Adhesive Tape for XYZ Positioner			1 each	1 each			Dxx0-PT-TAPE
†Browser Wand for PT Tip			1 each	1 each			Dxx0-PT-WAND
†Interlock Pieces for PT Tip			1 each	1 each			Dxx0-PT-INTERLOCK
†Swivel for PT Tip			1 each	1 each			Dxx0-PT-SWIVEL
Platform/Cable Assembly Kit (includes items below with‡)	1 each		1 each				WL-PLINK-CASE or WL-BUS-CASE
‡Platform/Cable Assembly	1 each		1 each				
‡Freehand Probe Holder	1 each		1 each				PACC-MS001
‡Probe Deskew Fixture	1 each		1 each				PCF200
‡Platform/Cable Assembly Mounting Clip	1 each		1 each		1 each	1 each	PK600ST-4 includes clips and clamps
‡Probe Cable Clamp	2 each		2 each		1 each	1 each	PK600ST-4 includes clips and clamps
‡Deluxe Soft Carrying Case	1 each		1 each				SAC-03
‡Foam Insert for Deluxe Case	1 each		1 each				921081-00 (WL-PLINK-CASE) or 921079-00 (WL-PBUS-CASE)
‡Protective Storage Case	1 each		1 each				921083-00
‡Plastic Tray for Storage Case	1 each		1 each				921078-00
HiTemp Solder-In Lead					1 each		Dx10-SI-HiTemp, Dx20-SI-HiTemp
HiTemp Cable					1 matched set		Dxx0-Cable-HiTemp
Calibration Certificate							See Ordering Information

Recommended Accessories

Deskew Test Fixture
Cascade Microtech EZ-Probe Positioner

TF-DSQ
EZ PROBE

SPECIFICATIONS

	D610, D610-PS	D620, D620-PS	D410, D410-PS	D420, D420-PS	D600A-AT	D400A-AT
Bandwidth* (Probe only, guaranteed) (System bandwidth, typical)	Dx10-SI and Dx10-PT Tips 6 GHz Dx10-HiTemp 5 GHz Dx10-QC Tip 4 GHz Dx10-SP Tip 3 GHz	Dx20-SI and Dx20-PT Tips 6 GHz Dx20-HiTemp 5 GHz Dx20-QC Tip 4 GHz Dx20-SP Tip 3 GHz	Dx10-SI, Dx10-HiTemp, Dx10-QC and Dx10-PT Tips 4 GHz Dx10-SP Tip 3 GHz	Dx20-SI, Dx20-HiTemp, Dx20-QC and Dx20-PT Tips 4 GHz Dx20-SP Tip 3 GHz	6 GHz	4 GHz
Rise Time* (10–90%)	Dx10-SI and Dx10-PT Tips 75 ps (typical) Dx10-HiTemp 90 ps (typical) Dx10-QC Tip 122.5 ps (typical) Dx10-SP Tip 150 ps (typical)	Dx20-SI and Dx20-PT Tips 75 ps (typical) Dx20-HiTemp 90 ps (typical) Dx20-QC Tip 122.5 ps (typical) Dx20-SP Tip 150 ps (typical)	Dx10-SI, Dx10-HiTemp, and Dx10-PT Tips 112 ps (typical) Dx10-QC Tip 122.5 ps (typical) Dx10-SP Tip 150 ps (typical)	Dx20-SI, Dx20-HiTemp, and Dx20-PT Tips 112 ps (typical) Dx20-QC Tip 122.5 ps (typical) Dx20-SP Tip 150 ps (typical)	<75 ps (typical)	<112 ps (typical)
Rise Time* (20–80%)	Dx10-SI and Dx10-PT Tips 56 ps (typical) Dx10-HiTemp 67.5 ps (typical) Dx10-QC Tip 92 ps (typical) Dx10-SP Tip 113 ps (typical)	Dx20-SI and Dx20-PT Tips 56 ps (typical) Dx20-HiTemp 67.5 ps (typical) Dx20-QC Tip 92 ps (typical) Dx20-SP Tip 113 ps (typical)	Dx10-SI, Dx10-HiTemp, and Dx10-PT Tips 84 ps (typical) Dx10-QC Tip 92 ps (typical) Dx10-SP Tip 113 ps (typical)	Dx20-SI, Dx20-HiTemp, and Dx20-PT Tips 84 ps (typical) Dx20-QC Tip 92 ps (typical) Dx20-SP Tip 113 ps (typical)	56 ps (typical)	84 ps (typical)
Noise (System)	<36 nV/√Hz (2.8 mV _{rms}) (typical) Referred to input, 6 GHz bandwidth	<61 nV/√Hz (4.8 mV _{rms}) (typical) Referred to input, 6 GHz bandwidth	<36 nV/√Hz (2.3 mV _{rms}) (typical) Referred to input, 4 GHz bandwidth	<67 nV/√Hz (4.3 mV _{rms}) (typical) Referred to input, 4 GHz bandwidth	<74 nV/√Hz (5.8 mV _{rms}) (typical) Referred to input, 6 GHz bandwidth	<74 nV/√Hz (4.7 mV _{rms}) (typical) Referred to input, 4 GHz bandwidth

Input

Input Dynamic Range (Nominal)	2.5V _{pk-pk} , ±1.25V	5V _{pk-pk} , ±2.5V	2.5V _{pk-pk} , ±1.25V	5V _{pk-pk} , ±2.5V	4.8V _{pk-pk} , ±2.4V	
Input Common Mode Voltage Range (Nominal)	±4 V				±2.4 V _{max}	
Input Offset Voltage Range	±3 V Differential (nominal)				n/a	
Non-destructive Input Range (Nominal)	±20 V				±18 V	
Attenuation	1.7X / 1.0X (nominal)	3.2X / 1.9X (nominal)	1.7X / 1.0X (nominal)	3.2X / 1.9X (nominal)	2.5X	
DC Input Resistance (Nominal)	200 kΩ Differential 50 kΩ Common Mode				4 kΩ Differential 2 kΩ Common Mode	
Impedance (Z_{min}, typical)	Dx10-SI Lead, Dx10-HiTemp >175 Ω Differential† Dx10-PT Tip >175 Ω Differential† Dx10-QC Tip >125 Ω Differential† Dx10-SP Tip >40 Ω Differential†	Dx20-SI Lead, Dx20-HiTemp >250 Ω Differential† Dx20-PT Tip >175 Ω Differential† Dx20-QC Tip >125 Ω Differential† Dx20-SP Tip >40 Ω Differential†	Dx10-SI Lead, Dx10-HiTemp >200 Ω Differential† Dx10-PT Tip >175 Ω Differential† Dx10-QC Tip >100 Ω Differential† Dx10-SP Tip >40 Ω Differential†	Dx20-SI Lead, Dx20-HiTemp >350 Ω Differential† Dx20-PT Tip >175 Ω Differential† Dx20-QC Tip >100 Ω Differential† Dx20-SP Tip >40 Ω Differential†	>200 Ω Differential	>450 Ω Differential through entire frequency range
Impedance (Mid-band, typical)	Dx10-SI Lead, Dx10-HiTemp 275 Ω at 3 GHz, 175 Ω at 6 GHz Dx10-PT Tip 200 Ω at 3 GHz, 200 Ω at 6 GHz Dx10-QC Tip 125 Ω at 3 GHz, 125 Ω at 6 GHz Dx10-SP Tip 40 Ω at 3 GHz, 100 Ω at 6 GHz	Dx20-SI Lead, Dx20-HiTemp 475 Ω at 3 GHz, 250 Ω at 6 GHz Dx20-PT Tip 200 Ω at 3 GHz, 200 Ω at 6 GHz Dx20-QC Tip 125 Ω at 3 GHz, 200 Ω at 6 GHz Dx20-SP Tip 40 Ω at 3 GHz, 175 Ω at 6 GHz	Dx10-SI Lead, Dx10-HiTemp 400 Ω at 2 GHz, 200 Ω at 4 GHz Dx10-PT Tip 275 Ω at 2 GHz, 175 Ω at 4 GHz Dx10-QC Tip 150 Ω at 2 GHz, 125 Ω at 4 GHz Dx10-SP Tip 75 Ω at 2 GHz, 15 Ω at 4 GHz	Dx20-SI Lead, Dx20-HiTemp 700 Ω at 2 GHz, 350 Ω at 4 GHz Dx20-PT Tip 275 Ω at 2 GHz, 175 Ω at 4 GHz Dx20-QC Tip 150 Ω at 2 GHz, 150 Ω at 4 GHz Dx20-SP Tip 75 Ω at 2 GHz, 15 Ω at 4 GHz	650 Ω at 3 GHz, 200 Ω at 6 GHz (Differential)	1000 Ω at 2 GHz, 450 Ω at 4 GHz (Differential)
CMRR (Typical)	30 dB DC to 10 MHz 26 dB 10 MHz to 6 GHz		30 dB DC to 10 MHz 26 dB 10 MHz to 4 GHz		>40 dB DC to 1 GHz >30 dB 1 GHz to 3 GHz >20 dB to 6 GHz	>40 dB DC to 1 GHz >30 dB 1 GHz to 3 GHz >20 dB 3 GHz to 4 GHz

Environmental

Temperature	Operating: 0 °C to 40 °C; Non-operating: -40 °C to 70 °C
Humidity	Operating: 5% to 80% RH (non-condensing), 50% RH above 30 °C Non-operating: 5% to 95% RH (non-condensing), 75% RH above 30 °C and 45% RH above 40 °C
ESD Tolerance	2 kV (typical), 100 pF, 300 Ω HBM

Dimensions

Dx10-PT/Dx20-PT Positioner Tip and Dx00A-AT Browser	0 to 3.5 mm (0 to 0.14"), 305 μm (0.012") diameter 0.55 mm (0.022") Z-axis compliance	0 to 3.0 mm (0 to 0.12"), 75 μm diameter 2 mm Z-axis compliance
Dx10-SI/Dx20-SI	0 to 11 mm (0 to 0.43") tip spread at circuit connection	NA
Dx10-QC/Dx20-QC Tips		
Cable Length	1.3 m (4 ft. 3 in) for both WL-PLink and WL-PBUS, sold separately	

* All Bandwidth and Rise Time measurements are made with an oscilloscope bandwidth greater or equal to the probe bandwidth

† Through entire frequency range

ORDERING INFORMATION

Product Description Product Code

Complete Probe Systems

4 GHz Complete Probe System with Dx10-SI Solder-In Tip (Qty. 1), Dx10-SP Square Pin (Qty. 1), Dx10-QC Quick Connect (Qty. 1), and Dx10-PT-KIT Positioner Tip Browser (Qty. 1)	D410-PS
4 GHz Complete Probe System with Dx20-SI Solder-In Tip (Qty. 1), Dx20-SP Square Pin (Qty. 1), Dx20-QC Quick Connect (Qty. 1), and Dx20-PT-KIT Positioner Tip Browser (Qty. 1)	D420-PS
6 GHz Complete Probe System with Dx10-SI Solder-In Tip (Qty. 1), Dx10-SP Square Pin (Qty. 1), Dx10-QC Quick Connect (Qty. 1), and Dx10-PT-KIT Positioner Tip Browser (Qty. 1)	D610-PS
6 GHz Complete Probe System with Dx20-SI Solder-In Tip (Qty. 1), Dx20-SP Square Pin (Qty. 1), Dx20-QC Quick Connect (Qty. 1), and Dx20-PT-KIT Positioner Tip Browser (Qty. 1)	D620-PS

Amplifier and Probe Tip Modules

WaveLink D410 4 GHz/2.5Vp-p Differential Probe Amplifier with Dx10-SI Solder-In Tip (Qty. 1), Dx10-SP Square Pin (Qty. 1), and Dx10-QC Quick Connect (Qty. 1)	D410
WaveLink D420 4 GHz/5Vp-p Differential Probe Amplifier with Dx20-SI Solder-In Tip (Qty. 1), Dx20-SP Square Pin (Qty. 1), and Dx20-QC Quick Connect (Qty. 1)	D420
WaveLink D610 6 GHz/2.5Vp-p Differential Probe Amplifier with Dx10-SI Solder-In Tip (Qty. 1), Dx10-SP Square Pin (Qty. 1), and Dx10-QC Quick Connect (Qty. 1)	D610
WaveLink D620 6 GHz/5Vp-p Differential Probe Amplifier with Dx20-SI Solder-In Tip (Qty. 1), Dx20-SP Square Pin (Qty. 1), and Dx20-QC Quick Connect (Qty. 1)	D620
WaveLink D400A-AT 4 GHz/4.8Vp-p Differential Amplifier Module with Adjustable Tip	D400A-AT
WaveLink D600A-AT 6 GHz/4.8Vp-p Differential Amplifier Module with Adjustable Tip	D600A-AT

Positioner Tip (Browser) Kits

WaveLink Dx10-PT Adjustable Positioner Tip Kit. For use with Dx10 amplifiers.	Dx10-PT-KIT
WaveLink Dx20-PT Adjustable Positioner Tip Kit. For use with Dx20 amplifiers.	Dx20-PT-KIT

Probe Platform/Cable Assemblies and Adapters

WaveLink ProLink Platform/Cable Assembly Kit with complete soft carrying case for all probe items.	WL-PLINK-CASE
WaveLink ProBus Platform/Cable Assembly Kit with complete soft carrying case for all probe items.	WL-PBUS-CASE

Hi-Temp Leads

WaveLink Temperature Extension Cables for Dx10. Includes set of Matched 30" High Temperature Cables (Qty. 1) and solder-in lead set (Qty. 1)	Dx10-HiTemp
WaveLink Temperature Extension Cables for Dx20. Includes set of Matched 30" High Temperature Cables (Qty. 1) and solder-in lead set (Qty. 1)	Dx20-HiTemp

Product Description Product Code

Accessories

Cascade Microtech EZ-Probe Positioner	EZ PROBE
Probe Deskew and Calibration Test Fixture	TF-DSQ

Calibration Options

NIST Calibration for D410. Includes test data.	D410-CCNIST
NIST Calibration for D420. Includes test data.	D420-CCNIST
NIST Calibration for D610. Includes test data.	D610-CCNIST
NIST Calibration for D620. Includes test data.	D620-CCNIST
NIST Calibration for D400A-AT. Includes test data.	D400A-AT-CCNIST
NIST Calibration for D600A-AT. Includes test data.	D600A-AT-CCNIST

Replacement Parts

Replacement Dx10-SI 4 & 6 GHz Solder-In Lead with Qty. 5 Spare Resistors.	Dx10-SI
Replacement Dx20-SI 4 & 6 GHz Solder-In Lead with Qty. 5 Spare Resistors.	Dx20-SI
Replacement Dx10-QC 4 & 6 GHz Quick Connect Lead	Dx10-QC
Replacement Dx20-QC 4 & 6 GHz Quick Connect Lead	Dx20-QC
Replacement Dx10-SP 4 & 6 GHz Square Pin Lead	Dx10-SP
Replacement Dx20-SP 4 & 6 GHz Square Pin Lead	Dx20-SP
Replacement SI Resistor Kit for Dx10/Dx20 - Kit of 20	PKxx0-SI
Replacement QC Resistor Kit for Dx10/Dx20 - 2 kits of 20	PKxx0-QC
Qty. 4 Replacement Pogo Pin Tips and Qty. 2 Replacement Sockets for Dx10-PT and Dx20-PT Adjustable Positioner Tips.	Dxx0-PT-TIPS
Replacement Probe Tip Holder Kit	PK600ST-3
Replacement Platform/Cable Assembly Mounting Kit	PK600ST-4
Quantity 1 Package of Black Adhesive Pads (10/pkg) and Quantity 1 Package of White Adhesive Pads (10/pkg)	Dxx0-PT-TAPE
Quantity 1 Package of Adhesive Probe Connection Guides (200 individual guides/package)	Dxx0-PT-GUIDES

Customer Service

Teledyne LeCroy oscilloscopes and probes are designed, built, and tested to ensure high reliability. In the unlikely event you experience difficulties, our digital oscilloscopes are fully warranted for three years and our probes are warranted for one year.

This warranty includes:

- No charge for return shipping
- Long-term 7-year support
- Upgrade to latest software at no charge



1-800-5-LeCroy
teledynelecroy.com

Local sales offices are located throughout the world.
Visit our website to find the most convenient location.

Данный компонент на территории Российской Федерации

Вы можете приобрести в компании MosChip.

Для оперативного оформления запроса Вам необходимо перейти по данной ссылке:

<http://moschip.ru/get-element>

Вы можете разместить у нас заказ для любого Вашего проекта, будь то серийное производство или разработка единичного прибора.

В нашем ассортименте представлены ведущие мировые производители активных и пассивных электронных компонентов.

Нашей специализацией является поставка электронной компонентной базы двойного назначения, продукции таких производителей как XILINX, Intel (ex.ALTERA), Vicor, Microchip, Texas Instruments, Analog Devices, Mini-Circuits, Amphenol, Glenair.

Сотрудничество с глобальными дистрибьюторами электронных компонентов, предоставляет возможность заказывать и получать с международных складов практически любой перечень компонентов в оптимальные для Вас сроки.

На всех этапах разработки и производства наши партнеры могут получить квалифицированную поддержку опытных инженеров.

Система менеджмента качества компании отвечает требованиям в соответствии с ГОСТ Р ИСО 9001, ГОСТ РВ 0015-002 и ЭС РД 009

Офис по работе с юридическими лицами:

105318, г.Москва, ул.Щербаковская д.3, офис 1107, 1118, ДЦ «Щербаковский»

Телефон: +7 495 668-12-70 (многоканальный)

Факс: +7 495 668-12-70 (доб.304)

E-mail: info@moschip.ru

Skype отдела продаж:

moschip.ru

moschip.ru_4

moschip.ru_6

moschip.ru_9