

Mifare RFID reader, 13.56MHz, w/o LED indicator,  
IEI Assembly Only, R11

# User Manual

# Revision

---

Date	Version	Changes
25 April, 2014	1.00	Initial release

# Copyright

---

## COPYRIGHT NOTICE

The information in this document is subject to change without prior notice in order to improve reliability, design and function and does not represent a commitment on the part of the manufacturer.

In no event will the manufacturer be liable for direct, indirect, special, incidental, or consequential damages arising out of the use or inability to use the product or documentation, even if advised of the possibility of such damages.

This document contains proprietary information protected by copyright. All rights are reserved. No part of this manual may be reproduced by any mechanical, electronic, or other means in any form without prior written permission of the manufacturer.

## TRADEMARKS

All registered trademarks and product names mentioned herein are used for identification purposes only and may be trademarks and/or registered trademarks of their respective owners.

# Table of Contents

<b>1 INTRODUCTION.....</b>	<b>1</b>
1.1 AFL2-MF-RFID-KIT SERIES RFID READER OVERVIEW .....	2
1.2 MODEL VARIATIONS .....	2
1.2.1 AFL2-MF-RFID-KIT Series Features.....	2
1.3 TECHNICAL SPECIFICATIONS .....	3
1.4 DIMENSIONS.....	4
<b>2 CONNECTORS .....</b>	<b>5</b>
2.1 AFL2-MF-RFID-KIT SERIES RFID READER MODULE .....	6
2.1.1 AFL2-MF-RFID-KIT Series Layout.....	6
2.1.2 Peripheral Interface Connectors .....	6
2.2 INTERNAL PERIPHERAL CONNECTORS .....	6
2.2.1 Antenna Connector .....	7
2.2.2 RS-232 and USB Connector (RFID1).....	7
2.2.3 CPU JTAG Port (CN1) .....	7
2.2.4 UART Jump (J5).....	8
<b>3 INSTALLATION .....</b>	<b>9</b>
3.1 ANTI-STATIC PRECAUTIONS .....	10
3.1.1 Unpacking .....	10
<b>4 GUI PROGRAM.....</b>	<b>12</b>
4.1 CHAPTER OVERVIEW .....	13
4.2 SOFTWARE INSTALLATIONS .....	13
4.2.1 Virtual COM Port Driver Installation .....	13
4.2.2 Hardware Installation.....	13
4.2.3 Software GUI Installation.....	14
4.3 SOFTWARE INTERFACE.....	17
4.3.1 Program Control Window (Lower Right-Hand Corner) .....	18
4.3.2 Protocol Tab Window .....	18
4.3.3 Utility Tabs Window .....	18

**AFL2-MF-RFID-KIT Series**

4.3.4	<i>Flags Window</i> .....	18
4.3.5	<i>Command (Request) Window</i> .....	18
4.3.6	<i>Log Window</i> .....	18
4.3.7	<i>Tag Data Window</i> .....	19
4.3.8	<i>RSSI Window</i> .....	19
4.3.9	<i>Special Functions Window</i> .....	20
4.3.10	<i>Other Functions</i> .....	21
4.4	<b>SET PROTOCOL</b> .....	21
4.5	<b>ISO/IEC 15693 PROTOCOL</b> .....	22
4.5.1	<i>Inventory</i> .....	22
4.5.2	<i>Read Single Block</i> .....	24
4.5.3	<i>Write Single Block</i> .....	25
4.5.4	<i>Lock Block</i> .....	27
4.5.5	<i>Read Multiple Blocks</i> .....	29
4.5.6	<i>Write Multiple Blocks</i> .....	30
4.5.7	<i>Stay Quiet</i> .....	32
4.5.8	<i>Select</i> .....	33
4.5.9	<i>Reset to Ready</i> .....	34
4.5.10	<i>Write AFI (Application Family Identifier)</i> .....	35
4.5.11	<i>Lock AFI (Application Family Identifier)</i> .....	37
4.5.12	<i>Write DSFID (Data Storage Format ID)</i> .....	38
4.5.13	<i>Lock DSFID (Data Storage Format ID)</i> .....	39
4.5.14	<i>Get System Info</i> .....	41
4.5.15	<i>Get Multiple-Block Security Status (Get Mult_Blkl Sel Status)</i> .....	42
4.6	<b>FIND TAGS</b> .....	44
<b>A MULTIPLE TAGS WRITING INSTRUCTION</b> .....		<b>45</b>
A.1	<b>INVENTORY REQUEST</b> .....	46
A.2	<b>NON - ADDRESSED MODE</b> .....	46
A.3	<b>ADDRESSED MODE</b> .....	47
A.4	<b>SELECTED MODE</b> .....	49
<b>B TESTDII PROGRAM</b> .....		<b>54</b>
B.1	<b>INTRODUCTION</b> .....	55
B.2	<b>HOW TO USE</b> .....	55

B.3 TAG INFORMATION STRUCTURE .....	56
<i>B.3.1 Tag Flag</i> .....	56
<i>B.3.2 Tag Data</i> .....	56
<i>B.3.3 Tag Info</i> .....	57
<i>B.3.4 RSSI</i> .....	58
<i>B.3.5 Request Command Type</i> .....	58
B.4 SOFTWARE APIS.....	59
<i>BOOL IRFR_FindPort ( void )</i> .....	59
<i>BOOL IRFR_FindSinglePort ( char * Port )</i> .....	59
<i>int IRFR_logAddFile ( char * msg )</i> .....	60
<i>Int IRFR_logAddScreen ( char * msg )</i> .....	60
<i>void IRFR_SetFilePath ( char * path )</i> .....	60
<i>void IRFR_SetLogger ( CEdit *logger )</i> .....	61
<i>void IRFR_SetLogFile ( bool result )</i> .....	61
<i>void IRFR_SetLogScreen ( bool result )</i> .....	62
<i>int IRFR_SetProtocol ( TagFlag tf );</i> .....	62
<i>int IRFR_RequestExecute ( int cmdno, char *reply, TagFlag tf, TagData *td )</i> ....	63
<i>void IRFR_FindRun ( char *TagIDs, char *TagNum )</i> .....	63
<i>void IRFR_FindStop ( void )</i> .....	64
<i>void IRFR_GetUIDs ( char *reply, char *TagIDs[ ], char *TagNum )</i> .....	64
<i>void IRFR_GetRSSI ( char *reply, RSSI RSSIs[ ] )</i> .....	65
<i>void IRFR_GetBlockData ( char *reply, TagData *td )</i> .....	65
<i>void IRFR_GetMultiBlockData ( char *reply, TagData *td );</i> .....	66
<i>void IRFR_GetTagInfo ( char *reply, TagInfo *ti, TagFlag tf, TagData td )</i> .....	66
<i>void IRFR_GetMultiBlockSecurity ( char *reply, char *SecurityData )</i> .....	67
B.5 EXAMPLE CODE.....	67
<b>C ISO/IEC 15693 REFERENCE MATERIAL .....</b>	<b>68</b>
C.1 UID FORMAT.....	69
C.2 TAG MEMORY ORGANIZATION.....	69
C.3 FLAG DEFINITIONS .....	70
C.4 APPLICATION FAMILY IDENTIFIER (AFI) DEFINITIONS .....	70
<b>D HAZARDOUS MATERIALS DISCLOSURE .....</b>	<b>72</b>
D.1 HAZARDOUS MATERIALS DISCLOSURE TABLE FOR IPB PRODUCTS CERTIFIED AS	

AFL2-MF-RFID-KIT Series

ROHS COMPLIANT UNDER 2002/95/EC WITHOUT MERCURY ..... 73

# List of Figures

---

Figure 1-1: AFL2-MF-RFID-KIT Series RFID Reader.....	2
Figure 2-2: AFL2-MF-RFID-KIT Series Dimensions (mm).....	4
Figure 2-6: Connector and Jumper Locations.....	6
Figure 4-1: FTDI Driver Installation Complete .....	13
Figure 4-2: IRFR-100 Control COM Ports .....	14
Figure 4-3: Properties.....	15
Figure 4-4: Device Manager .....	15
Figure 4-5: Device Manager - Ports .....	16
Figure 4-6: Software Interface .....	17
Figure 4-7: Log Window .....	19
Figure 4-8: RSSI Window .....	20
Figure 4-9: Set Protocol .....	22
Figure 4-10: Inventory .....	23
Figure 4-11: Read Single Block.....	25
Figure 4-12: Write Single Block.....	26
Figure 4-13: Lock Block .....	28
Figure 4-14: Read Multiple Blocks .....	30
Figure 4-15: Write Multiple Block.....	31
Figure 4-16: Stay Quiet .....	32
Figure 4-17: Select.....	34
Figure 4-18: Reset to Ready .....	35
Figure 4-19: Write AFI.....	36
Figure 4-20: Lock AFI .....	37
Figure 4-21: Write DSFID .....	39
Figure 4-22: Lock DSFID .....	40
Figure 4-23: Get System Info.....	41
Figure 4-24: Get Multiple-Block Security Status .....	43
Figure 4-25: .....	44



# List of Tables

---

<b>Table 1-1: Model Variations .....</b>	<b>2</b>
<b>Table 1-2: Technical Specifications .....</b>	<b>3</b>
<b>Table 2-1: Peripheral Interface Connectors and Indicators .....</b>	<b>6</b>
<b>Table 2-2: RS-232 and USB Connector Pinouts .....</b>	<b>7</b>
<b>Table 2-3: CPU JTAG Port Pinouts .....</b>	<b>7</b>
<b>Table 2-4: UART Jump Pinouts .....</b>	<b>8</b>
<b>Table 3-1: Package List Contents .....</b>	<b>11</b>

Chapter

1

# Introduction

---

## 1.1 AFL2-MF-RFID-KIT Series RFID Reader Overview

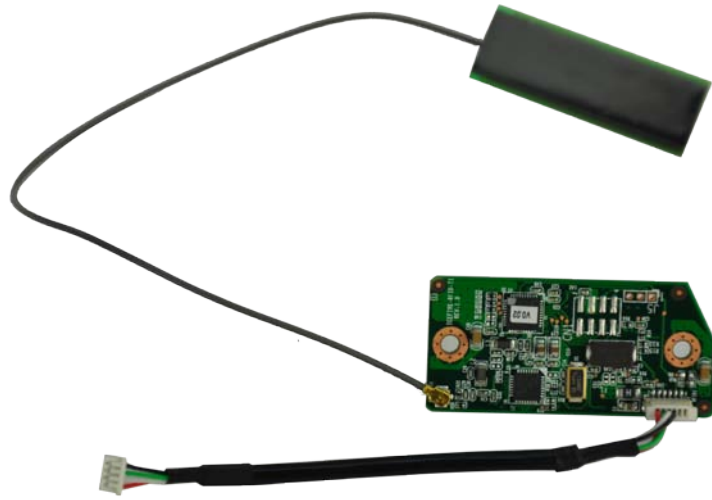

**Figure 1-1: AFL2-MF-RFID-KIT Series RFID Reader**

The AFL2-MF-RFID-KIT Series is a RFID reader for both High Frequency (HF) and Ultra High Frequency (UHF) RFID systems and is compliant with ISO 15693 and ISO 14443 industrial standards. The AFL2-MF-RFID-KIT Series also comes with a utility and a software development kit (SDK) for configuring reader module and writing/reading tags.

## 1.2 Model Variations

The model variations of the AFL2-MF-RFID-KIT Series are listed below.

Models	Series
AFL2-MF-RFID-KIT01-R11	for AFL2-W07A/08A Series
AFL2-MF-RFID-KIT02-R11	for AFL2-W10A/10A/12A/15A/W15B/17A/W19A Series
AFL2-MF-RFID-KIT03-R11	for AFL2-W21A Series

**Table 1-1: Model Variations**

### 1.2.1 AFL2-MF-RFID-KIT Series Features

The AFL2-MF-RFID-KIT Series has the following features

- 13.56 MHz radio frequency industrial RFID reading module

## AFL2-MF-RFID-KIT Series

- Supports standard protocol ISO 15693 for vicinity card applications reads multiple tags simultaneously
- Tag compatibility: TI , ST , Philips , Tag-it, HF-EPC
- Reader to reader anti-collision
- Reads and writes tags with up to 2Kb
- Single power supply and low power consumption
- Various interfaces to main system
  - 115.2 Kbps maximum serial communication speeds
  - USB

### 1.3 Technical Specifications

The specifications for the Intel based embedded systems are listed below.

	AFL2-MF-RFID-KIT Series
Support Protocol	ISO 15693
RF Frequency	13.56 MHz
RF Data Rate	6.62 kbps for ISO 15693
Baud Rate	9600 Kbps ~ 115,200 Kbps
Power Consumption	5V @ 150 mA
Operating Distance	10 cm
Interface	RS-232 serial port or USB
Operating Temperature	0°C ~ 60°C
Operating Humidity	10% ~ 85% RH
Tag Compatibility	RI, ST, Philips, Tag-it, HF-EPC
Driver Support	Windows XP Windows XPE Windows CE 5.0

**Table 1-2: Technical Specifications**

### 1.4 Dimensions

The dimensions of the AFL2-MF-RFID-KIT Series are listed below and shown in **Figure 2-2**.

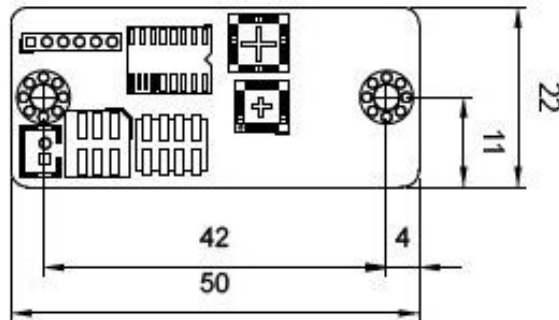

**Figure 2-2: AFL2-MF-RFID-KIT Series Dimensions (mm)**

Chapter

2

# Connectors

---

## 2.1 AFL2-MF-RFID-KIT Series RFID Reader Module

The following sections describe the relevant components and jumpers on the RFID reader module.

### 2.1.1 AFL2-MF-RFID-KIT Series Layout

**Figure 2-6** shows the on-board peripheral connectors.

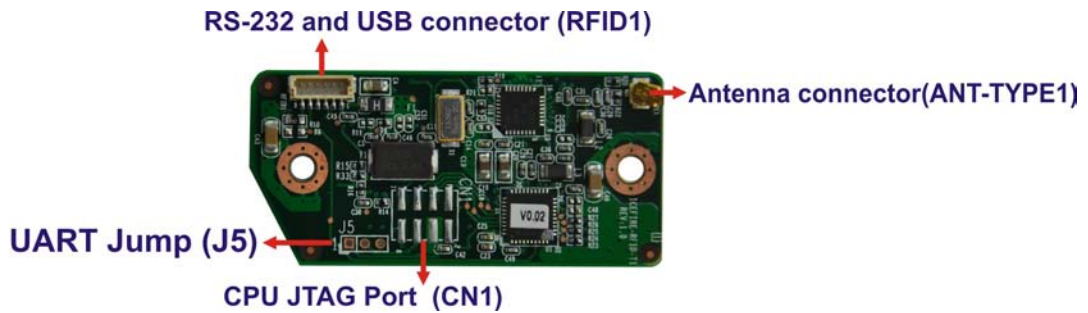

**Figure 2-1: Connector and Jumper Locations**

### 2.1.2 Peripheral Interface Connectors

**Table 2-1** shows a list of the peripheral interface connectors on the AFL2-MF-RFID-KIT Series. Detailed descriptions of these connectors can be found below.

Connector	Type	Label
Antenna connector	IPEX type connector	ANT-TYPE1
RS-232 and USB connector	6-pin header	RFID1
CPU JTAG Port	8-pin	CN1
UART Jump	2-pin	J5

**Table 2-1: Peripheral Interface Connectors and Indicators**

## 2.2 Internal Peripheral Connectors

This section has complete descriptions of all the internal peripheral connectors on the AFL2-MF-RFID-KIT Series.

## AFL2-MF-RFID-KIT Series

### 2.2.1 Antenna Connector

CN Label:       ANT-TYPE1  
 CN Type:        IPEX  
 CN Location:    See **Figure 2-6**

The Antenna Connector connects to the 13.56 MHz antenna module.

### 2.2.2 RS-232 and USB Connector (RFID1)

Pin No.	Description
1	USB5V
2	D+_1
3	D-_1
4	GND
5	RFID_BUZ#
6	EN

**Table 2-2: RS-232 and USB Connector Pinouts**

### 2.2.3 CPU JTAG Port (CN1)

Pin No.	Description
1	C_TCK
2	nRST
3	C_TMS
4	+3V3
5	C_TDI
6	GND
7	C_TDO
8	GND

**Table 2-3: CPU JTAG Port Pinouts**



### 2.2.4 UART Jump (J5)

Pin No.	Description
1	TXD
2	RXD
3	GND

**Table 2-4: UART Jump Pinouts**

Chapter

3

# Installation

---

### 3.1 Anti-static Precautions



**WARNING:**

If the following anti-static precautions are not followed, a user may be injured and the system irreparably damaged.

Electrostatic discharge (ESD) can cause serious damage to electronic components, including the AFL2-MF-RFID-KIT Series module. (Dry climates are especially susceptible to ESD.) It is therefore critical that whenever the AFL2-MF-RFID-KIT Series is opened and any electrical component handled, the following anti-static precautions are strictly adhered to.

- **Wear an anti-static wristband:** Wearing a simple anti-static wristband can help to prevent ESD from damaging the board.
- **Self-grounding:** Before handling the board, touch any grounded conducting material. During the time the board is handled, frequently touch any conducting materials that are connected to the ground.
- **Use an anti-static pad:** When configuring the AFL2-MF-RFID-KIT Series, place it on an anti-static pad. This reduces the possibility of ESD damaging the AFL2-MF-RFID-KIT Series.

#### 3.1.1 Unpacking

After the AFL2-MF-RFID-KIT Series is received make sure the following components are included in the package. If any of these components are missing, please contact the AFL2-MF-RFID-KIT Series reseller or vendor where it was purchased or contact an IEI sales representative immediately.

Quantity	Item	Image
1	IRFD-100/IRFR-100	

AFL2-MF-RFID-KIT Series

1	Utility and manual CD	
---	-----------------------	---

**Table 3-1: Package List Contents**

Chapter

4

# GUI Program

---

## 4.1 Chapter Overview

This chapter describes the installation and use of the USB drivers and IRFR-100 module control program.

## 4.2 Software Installations

Do not plug the module into the USB port until instructed to do so. If it is already connected to a USB port, disconnect it now.

Software installation is a two-step process. The first step is the installation of a third-party **virtual COM port (VCP) driver**, and the second part is the installation of the **IRFR-100 GUI program**.

### 4.2.1 Virtual COM Port Driver Installation

To install the virtual driver, unzip the **VCP\_driver.rar** and run the program **CDM\_setup.exe**. When the driver installation is complete, the following confirmation is displayed:



**Figure 4-1: FTDI Driver Installation Complete**

### 4.2.2 Hardware Installation

At this point, attach the IRFR-100 module to an open USB port. The module can be plugged directly into the port or attached at the end of a USB extension cable (type A, not supplied). At this point, the power LED should be lit. Any RFID tag corresponding to a supported protocol can be detected and is indicated by the corresponding LED.

### 4.2.3 Software GUI Installation

The software GUI is the file named **IRFR-100.rar**. It can be unzipped using a standard unzip program and is a self-contained executable. Create a folder where desired on the host PC, and unzip the executable into that folder. The program can be run from the folder, or a shortcut can be created and placed on the desktop of the host computer. In most cases, the program automatically detects the COM port. In case the program could not detect the COM port, enter the COM port number (e.g., COM3) in the Select Port window at the bottom right of the GUI as shown following, and click on the **Select Port** button).

**Support Port: COM1 ~ COM9.**

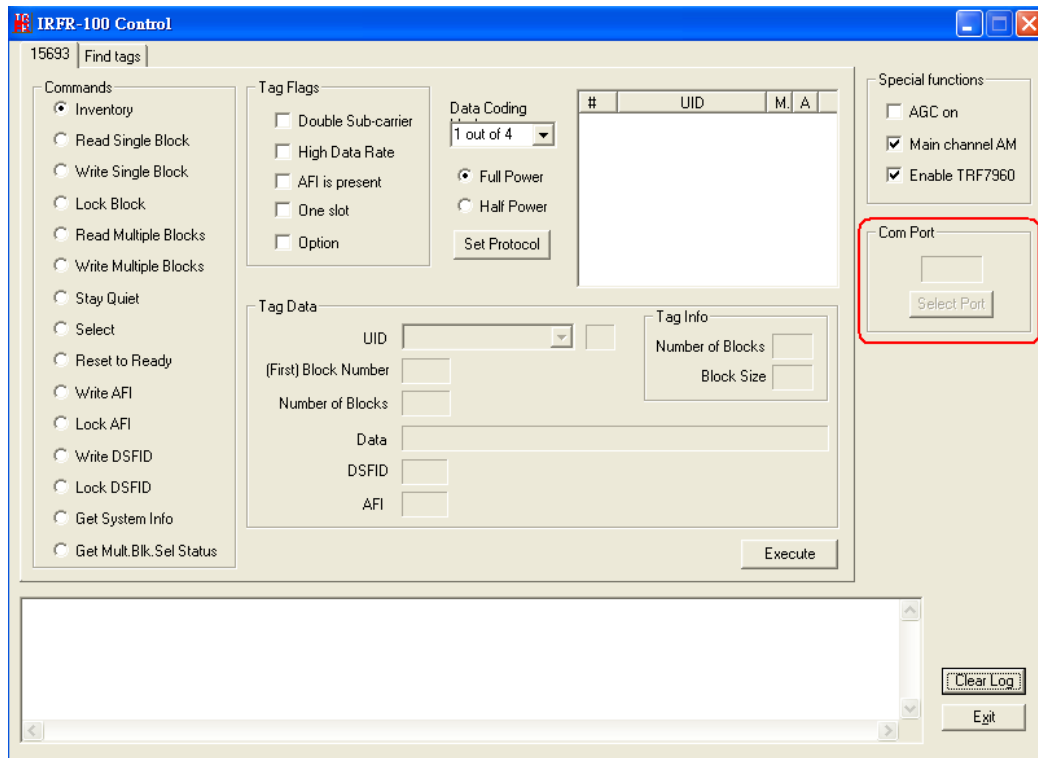

**Figure 4-2: IRFR-100 Control COM Ports**

To determine the USB serial port that corresponds to the IRFR-100 module, right-click on the My Computer icon on the desktop. When the drop-down menu appears, click on Properties.

AFL2-MF-RFID-KIT Series



Figure 4-3: Properties

On the properties window, select the Hardware tab:

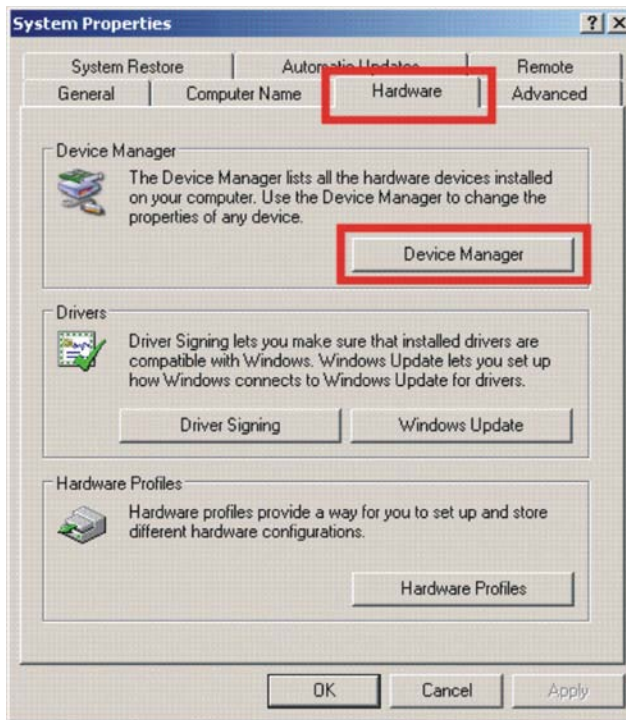
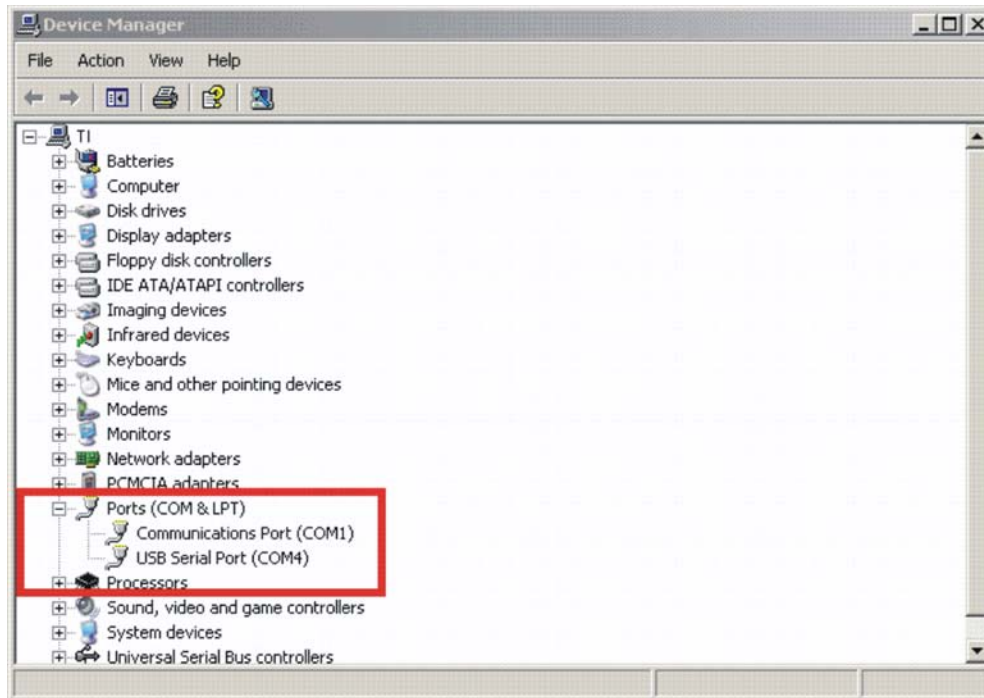

Figure 4-4: Device Manager

Next, click on *Device Manager*, then click the + sign next to *Ports* to expand the ports:





**Figure 4-5: Device Manager - Ports**

If the driver installation was successful and the module is plugged in, *USB Serial Port* should appear in the list of ports, followed by a port number (in this example, COM4). The actual port number may be different. Make note of the COM port number and enter it in the *Select Port* window of the GUI. Then select the *Select Port* on GUI (do not press the *Enter* key). Note: If the *Enter* key is pressed, the program ends and the GUI closes.

### 4.3 Software Interface

The GUI window is shown following. Each section of the window has a different function. The figure shows the arrangement for the *Protocol 15693* and *Find Tags*.

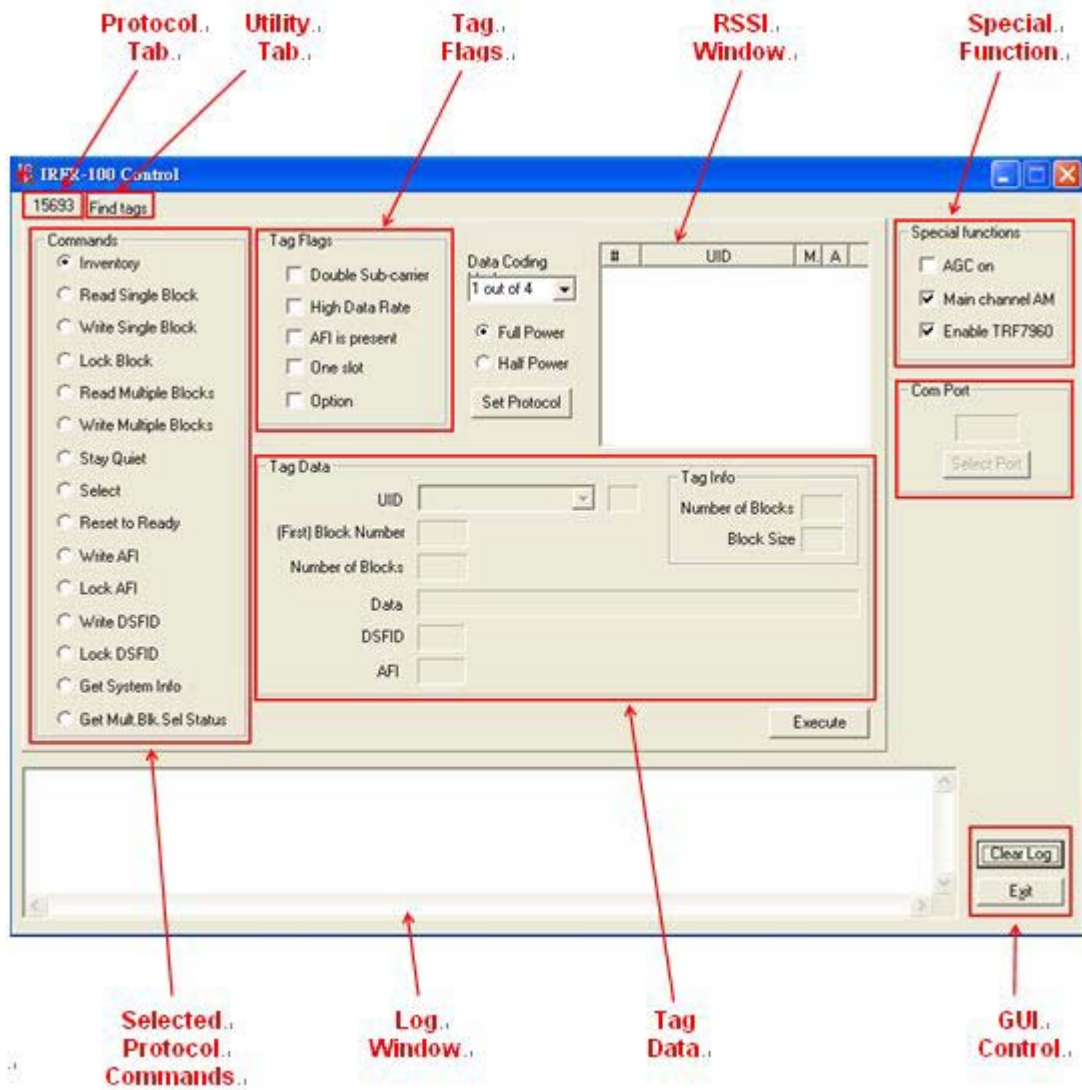

Figure 4-6: Software Interface

#### 4.3.1 Program Control Window (Lower Right-Hand Corner)

The Select Port window allows the user to enter manually the USB serial port used by the host computer to communicate with the IRFR-100 module.

Exit button – exits the IRFR-100 control program.

#### 4.3.2 Protocol Tab Window

The protocol tab window selects tag protocol and program functions. Available option is:

- (ISO/IEC) 15693 – vicinity cards

#### 4.3.3 Utility Tabs Window

Find Tags – a function that reads tags of protocol 15693

#### 4.3.4 Flags Window

This window allows the user to set flags for the 15693 protocol. Different flags may be available for different commands. The tag window automatically updates available flags depending on the request chosen.

#### 4.3.5 Command (Request) Window

This window shows various request options available for protocol 15693.

#### 4.3.6 Log Window

The log window shows all communication frames from host computer to IRFR-100 module. The tag response is also displayed in the log window. The tag response (register content) is always in parentheses to distinguish it from the host-to-reader data exchange. This information is also stored in the *IRFR-100.log* file, located in the same file directory as IRFR-100.exe, which can be opened by a normal text editor such as Notepad.

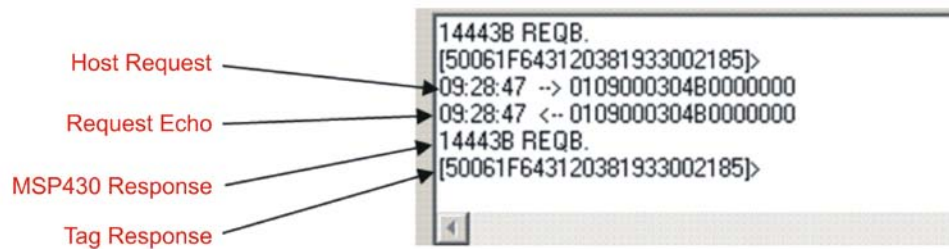

**Figure 4-7: Log Window**

#### 4.3.7 Tag Data Window

The *Tag Data* window is where the user enters addresses, data, number of bits, and other information required by certain commands. Checking certain flags in the *Flag* window may activate more fields for data entry.

#### 4.3.8 RSSI Window

The RSSI field displays the slot number, UID and the RSSI values of the corresponding tag. If there was a collision and the reader performed a second anticollision procedure, the slot numbers are indicated with an additional character:

A = second procedure      B = third procedure      and so on.

The main channel, which is **AM**, is used as the primary one, and **PM** is the auxiliary channel. The RSSI maximum value is **7** and minimum value is **0**. The corresponding RSSI values depend on the system design (antenna + reader), and the levels can vary based on the quality of the reception. The specifics of the corresponding input voltage levels to RSSI levels are defined in the TRF7960 data sheet.

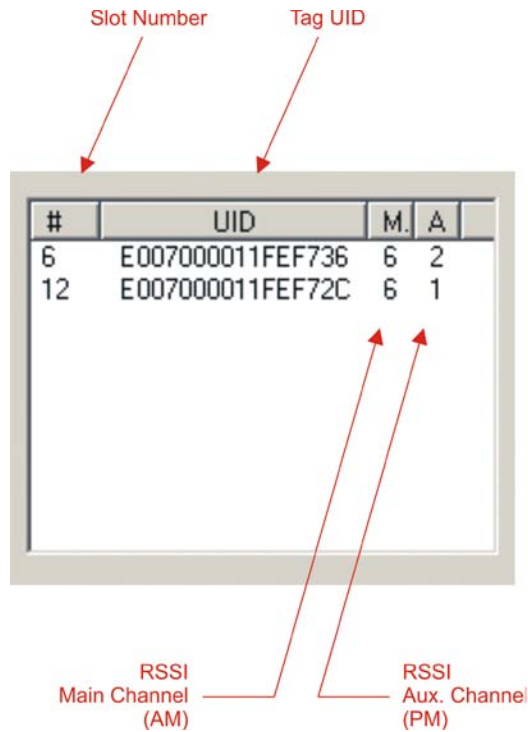

**Figure 4-8: RSSI Window**

In the preceding example, one can see that the tags in slots #6 and #12 have a main-channel RSSI value of 6, with auxiliary-channel RSSI values of 2 and 1, respectively.

#### 4.3.9 Special Functions Window

Special functions, such as AGC on/off, main channel AM, and enable/disable the TRF7960.

The AGC is turned off after the power-on reset (POR) and can be enabled when desired (especially in noisy environments). By default, the input channel is AM and can be switched to PM if the RSSI value for the PM channel is higher than the AM.

#### 4.3.10 Other Functions

Other functions on the main IRFR-100 control panel are:

- Set protocol - which configures the program for the selected protocol once the protocol tab has been selected
- Execute button - which processes the selected command
- Power control (half or full) - which can be used to simulate marginal reception conditions. The RF output power selection enables the user to switch between full power (200 mW) and half power (100 mW); however, the antenna matching circuit is tuned to operate with full-power selection, and performance is not optimal in half-power selection. This is due to the matching on the output of the reader IC, which currently is matched for 200 mW. (The load impedance for full power is 4 W and half power is 8 W.)
- Data coding mode - which is used in conjunction with the 15693 protocol

### 4.4 Set Protocol

IRFR-100 control program does not automatically set the program to that protocol. The user must manually click on the *Set Protocol* button:

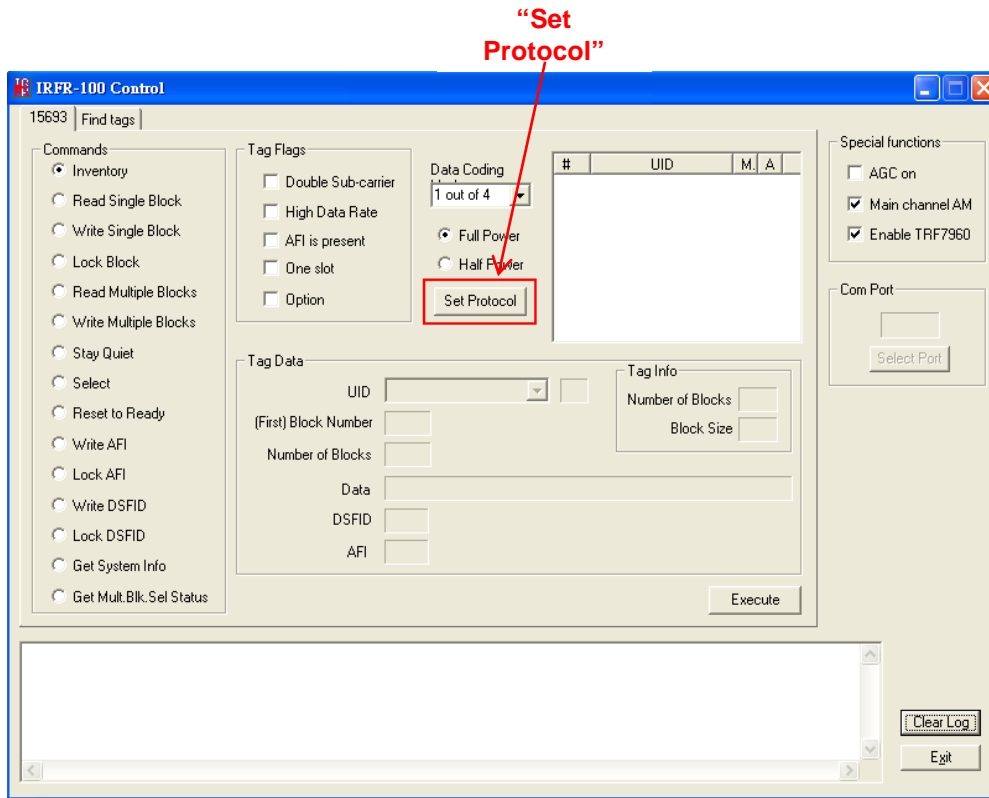

**Figure 4-9: Set Protocol**

When the *Set Protocol* button is pressed, the software sets the parameters for the corresponding protocol standard.

## 4.5 ISO/IEC 15693 Protocol

This section describes commands for the 15693 protocol. After a command has been selected by clicking on the associated command button in the Commands window, the user should set any flags as needed. If appropriate, enter data in the Tag Data window.

### 4.5.1 Inventory

The Inventory command is used to acquire the unique IDs (UID) of ISO 15693 tags in the read zone. The two inventory methods supported are 16-slotted and single-slot. A single-slot request allows all transponders in the read zone to reply to the Inventory request. In cases where more than one tag is present, such a request would cause a data collision, which in turn causes a reader to send a collision error message to the GUI. A 16-slot inventory sequence decreases the likelihood of a data collision by forcing

AFL2-MF-RFID-KIT Series

compliant transponders to respond in 1 of 16 slots, based on a portion of their UIDs. To perform a slotted sequence, the Slot Marker/End-of-Frame request is used in conjunction with this command. Any collision that does occur in a slotted sequence can be further arbitrated by using the anticollision mask in an algorithm similar to that outlined in the ISO 15693 standard.

To inventory a tag, the user should:

- Step 1: Click the button for Inventory in the Commands window
- Step 2: Click on any flags that must be set in the Tag Flags window
- Step 3: Click on Set Protocol
- Step 4: Execute the command

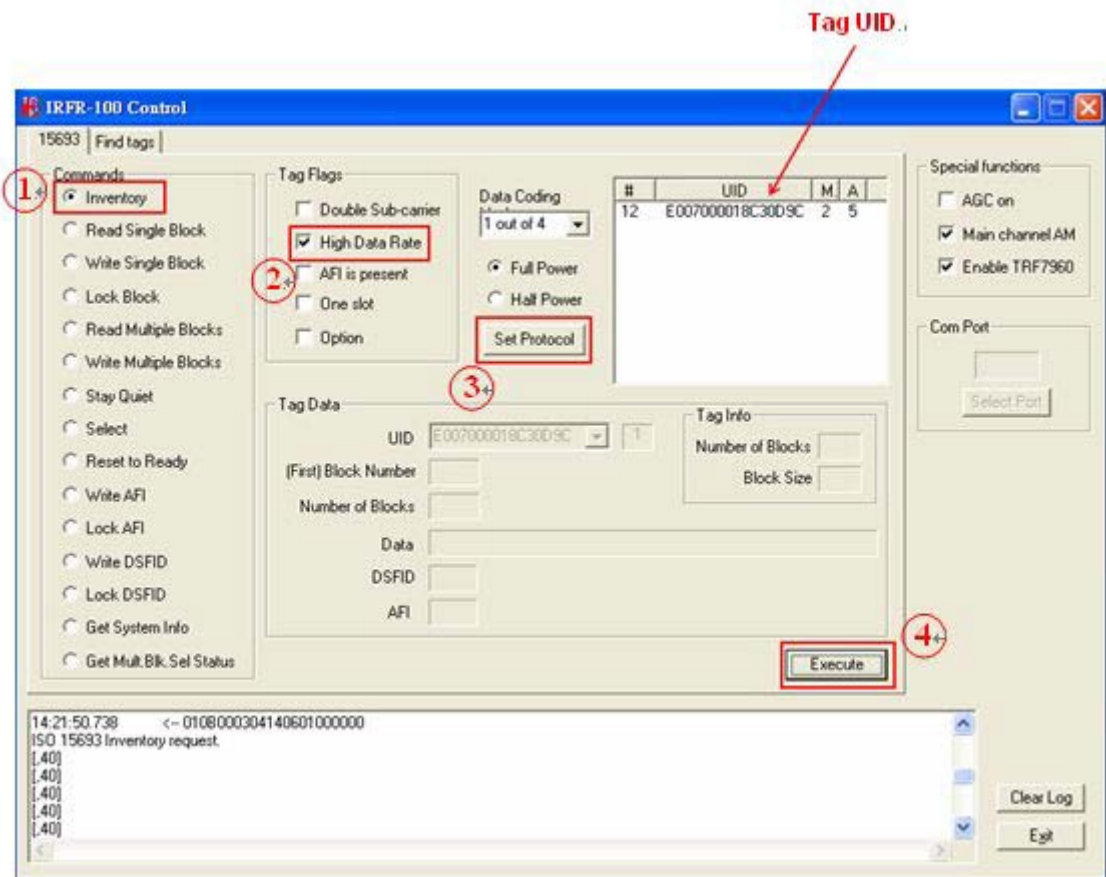

Figure 4-10: Inventory



#### 4.5.2 Read Single Block

The Read Single Block command gets the data from one memory block of the responding tag. In addition to this data, a Block Security Status byte can be requested. This byte shows the write-protection of the block specified [e.g., unlocked, (user/factory) locked, etc.].

To read a single block, the user should:

- Step 1:** Click the button for Read Single Block in the Commands window
- Step 2:** Click on any flags that must be set in the Tag Flags window
- Step 3:** Optionally select a tag from the UID pulldown list in the Tag Data window and set the Addressed flag (if only one tag is present, only one choice is available)
- Step 4:** Enter two hex digits corresponding to the block number in the (First) Block Number field in the Tag Data window
- Step 5:** Execute the command.

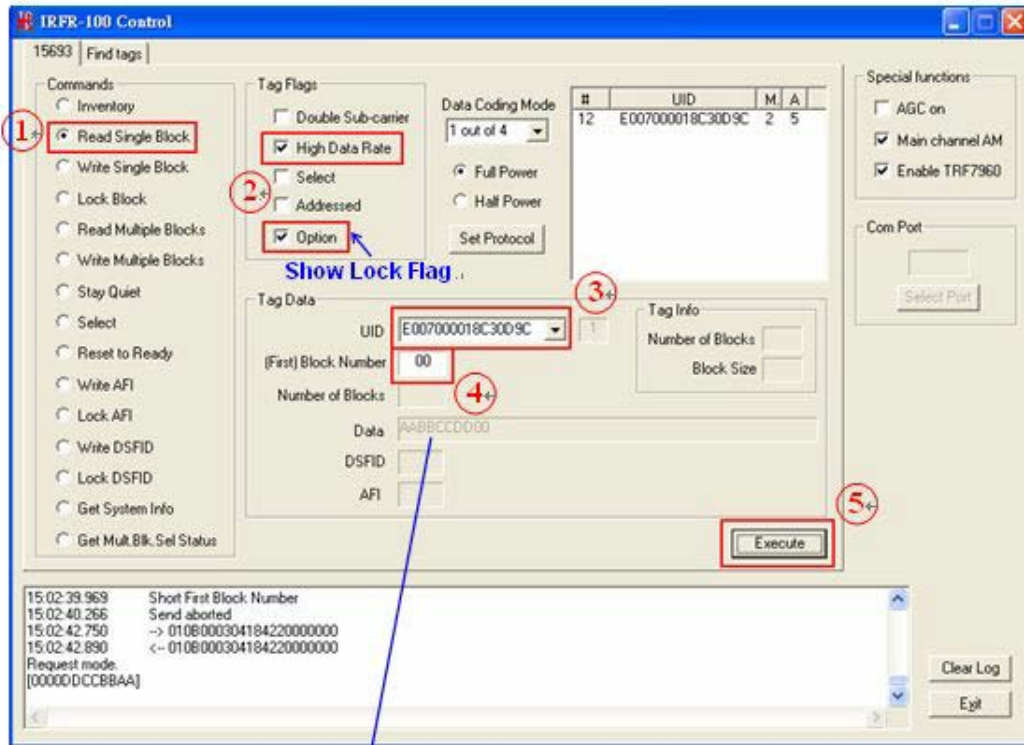

Data AABBCCDD00

Data: AABBCCDD ( 4 bytes in block 00 )

Lock Flag: 00 ( fifth byte means unlocked; if **01**, means locked )

Figure 4-11: Read Single Block

### 4.5.3 Write Single Block

The Write Single Block request writes data to one memory block of the addressed tag(s). In order to successfully write data, the host must know the size of the memory block of the tag. This information is available through the Get System Information request, if supported by the tag. A corrupted response or lack of response from TRF7960 does not necessarily indicate a failure to perform the write operation. Additionally, multiple transponders may process a nonaddressed request. (See [Appendix A](#) for more instructions)

To write a single block, the user should:

- Step 1: Click the button for Write Single Block in the Commands window
- Step 2: Click on any flags that must be set in the Tag Flags window
- Step 3: Optionally select a tag from the UID pulldown list in the Tag Data window and set the Addressed flag (if only one tag is present, only one choice is available)
- Step 4: Enter two hex digits corresponding to the block number in the (First) Block Number field in the Tag Data window
- Step 5: Enter 8 hexadecimal digits corresponding to the data to be written in the Data field in the Tag Data window
- Step 6: Execute the command

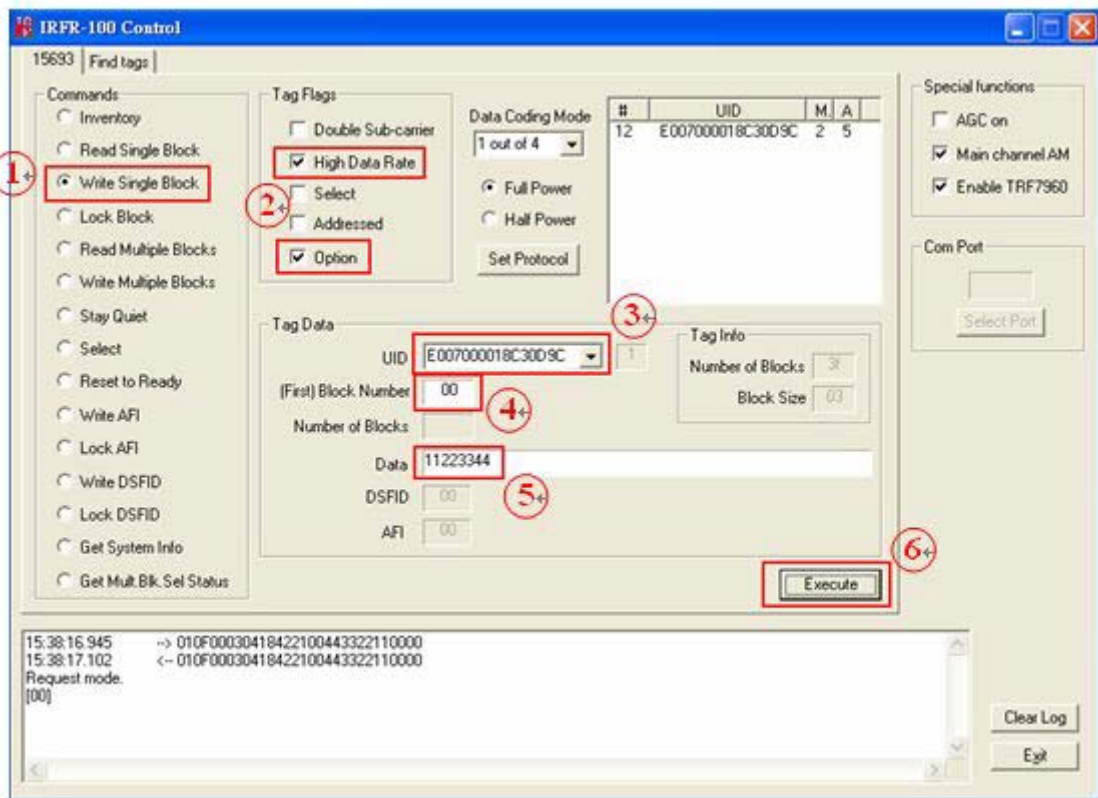

Figure 4-12: Write Single Block

#### 4.5.4 Lock Block

The Lock Block command write-protects one memory block of the addressed tag(s). A corrupted response or lack of response from the TRF7960 does not necessarily indicate a failure to perform the lock operation. Additionally, multiple transponders may process a non-addressed request.

**Used to permanently lock the requested block.**

To lock a block, the user should:

- Step 1:** Click the button for Lock Block in the Command window
- Step 2:** Click on any flags that must be set in the Tag Flags window
- Step 3:** Optionally select a tag from the UID pulldown list in the Tag Data window and set the Addressed flag (if only one tag is present, only one choice is available)
- Step 4:** Enter two hex digits corresponding to the block number in the (First) Block Number field in the Tag Data window
- Step 5:** Execute the command

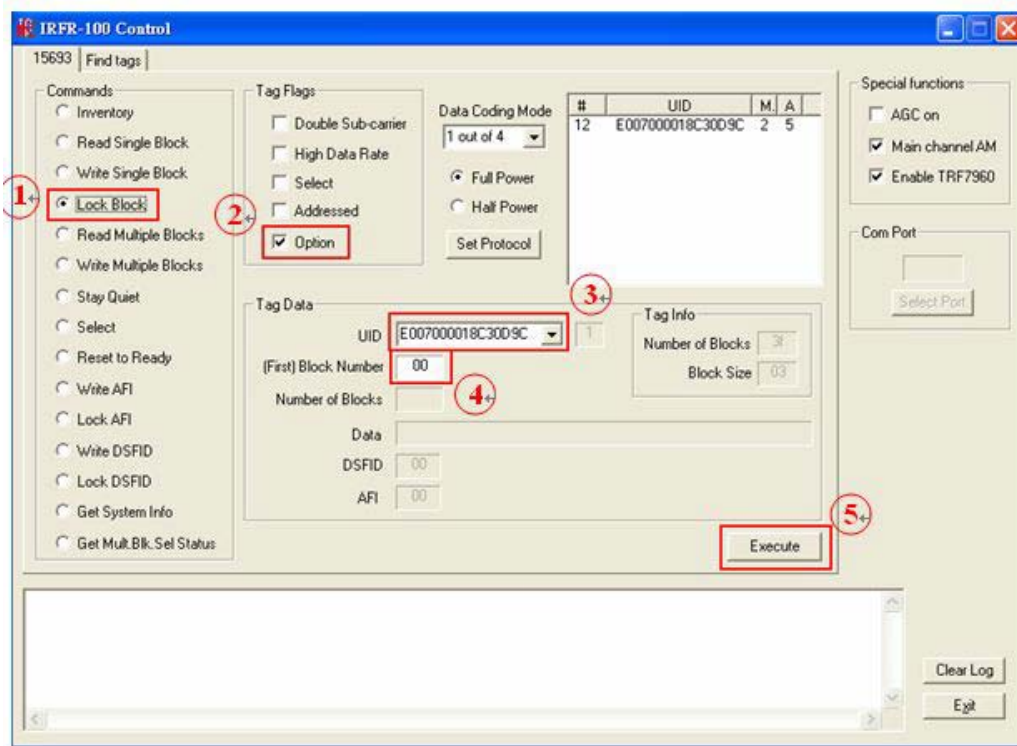

**Figure 4-13: Lock Block**



**NOTE:**

The [Option flag](#) of the ISO 15693 defined Request flags must be set for all Write and Lock commands to respond properly.

#### 4.5.5 Read Multiple Blocks

The Read Multiple Blocks command gets the data from multiple memory blocks of the responding tag. In addition to this data, a Block Security Status byte can be requested for each block. This byte shows the write-protection of the block specified [e.g., unlocked, (user/factory) locked, etc.].

To read multiple a blocks, the user should:

- Step 1:** Click the button for Read Multiple Blocks in the Commands window
- Step 2:** Click on any flags that must be set in the Tag Flags window
- Step 3:** Optionally select a tag from the UID pulldown list in the Tag Data window (if only one tag is present, only one choice is available)
- Step 4:** Enter two hex digits corresponding to the starting block number in the (First) Block Number field in the Tag Data window. The blocks are numbered from 00 to FF (0 to 255)
- Step 5:** Enter two hex digits corresponding to the number of blocks to be written in the Number of Blocks field in the Tag Data window. The number of blocks in the request is one less than the number of blocks that the tag returns in its response. E.g., a value of 06 in the Number of Blocks field requests to read 7 blocks. A value of 00 requests to read a single block
- Step 6:** Execute the command

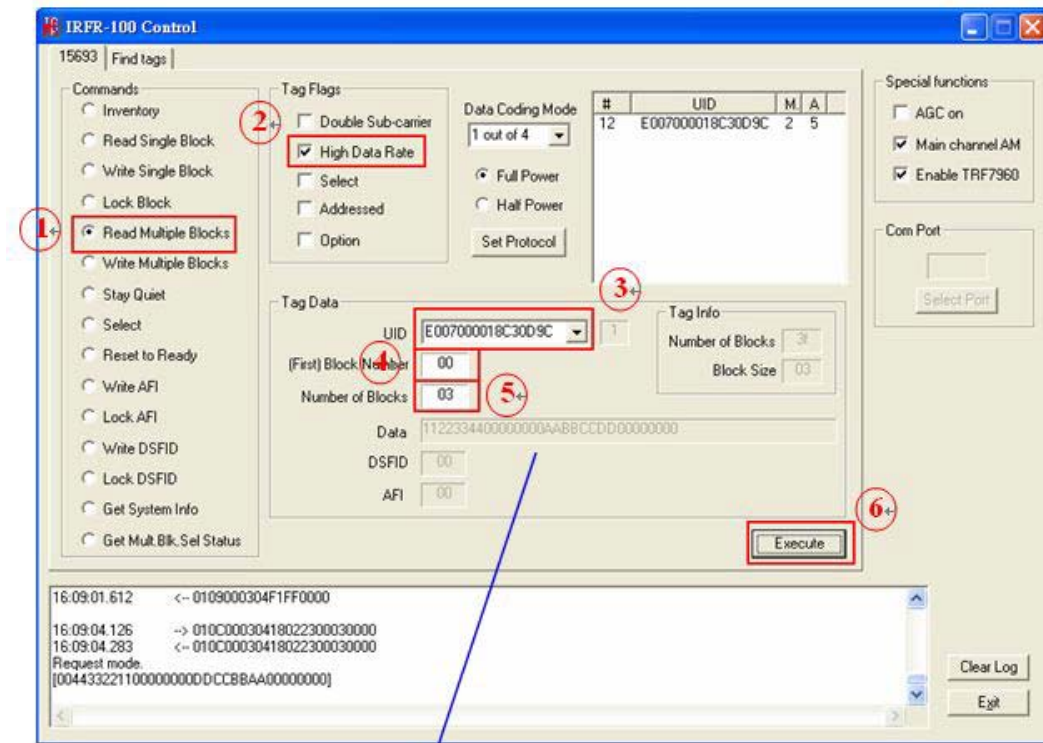

Data: 11223344 00000000 AABBCDD 00000000 ( 16 bytes in block 00-03 )

Figure 4-14: Read Multiple Blocks

#### 4.5.6 Write Multiple Blocks

The Write Multiple Blocks command writes data to multiple memory blocks of the addressed tags. In order to successfully write data, the host must know the size of the memory block of the tag. Write Multiple Blocks is an optional command, and may not be supported by the tag (see the following screen capture).

To write multiple blocks, the user should:

- Step 1: Click the button for Write Multiple Blocks in the Commands window
- Step 2: Click on any flags that must be set in the Tag Flags window
- Step 3: Optionally select a tag from the UID pulldown list in the Tag Data window (if only one tag is present, only one choice is available)

## AFL2-MF-RFID-KIT Series

- Step 4:** Enter two hex digits corresponding to the starting block number in the (First) Block Number field in the Tag Data window. The blocks are numbered from 00 to FF (0 to 255)
- Step 5:** Enter two hex digits corresponding to the number of blocks to be written in the Number of Blocks field in the Tag Data window. The number of blocks in the request is one less than the number of blocks that the tag returns in its response E.g., a value of 06 in the Number of Blocks field requests to read 7 blocks. A value of 00 requests a read of a single block
- Step 6:** Enter hexadecimal digits corresponding to the data to be written in the Data field in the Tag Data window
- Step 7:** Execute the command

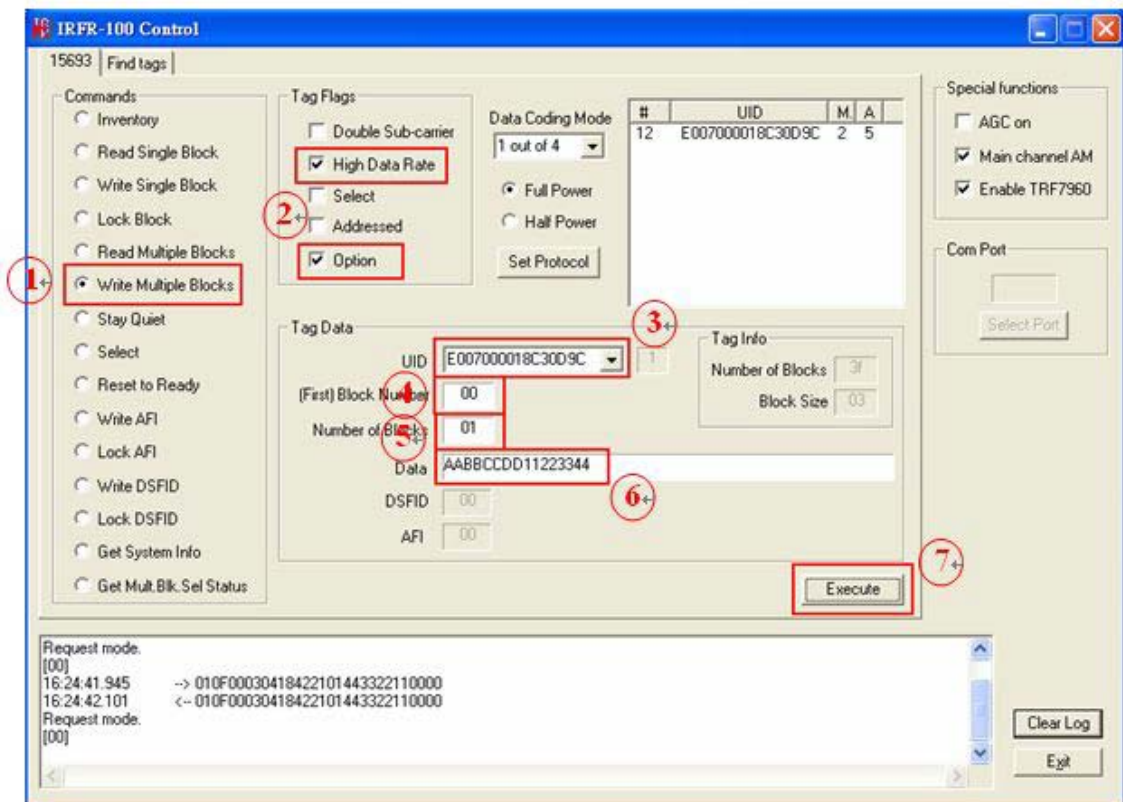

**Figure 4-15: Write Multiple Block**



### 4.5.7 Stay Quiet

The Stay Quiet command is used to silence a tag, preventing it from responding to any nonaddressed or inventory related commands. The tag does, however, respond to requests with matching UID. As there is no response to this request from the receiving tag, only request status and errors are reported.

To command a tag to stay quiet, the user should:

- Step 1:** Click the button for Stay Quiet in the Commands window
- Step 2:** Click on any flags that must be set in the Tag Flags window
- Step 3:** Optionally select a tag from the UID pulldown list in the Tag Data window and set the Addressed flag (if only one tag is present, only one choice is available)
- Step 4:** Execute the command

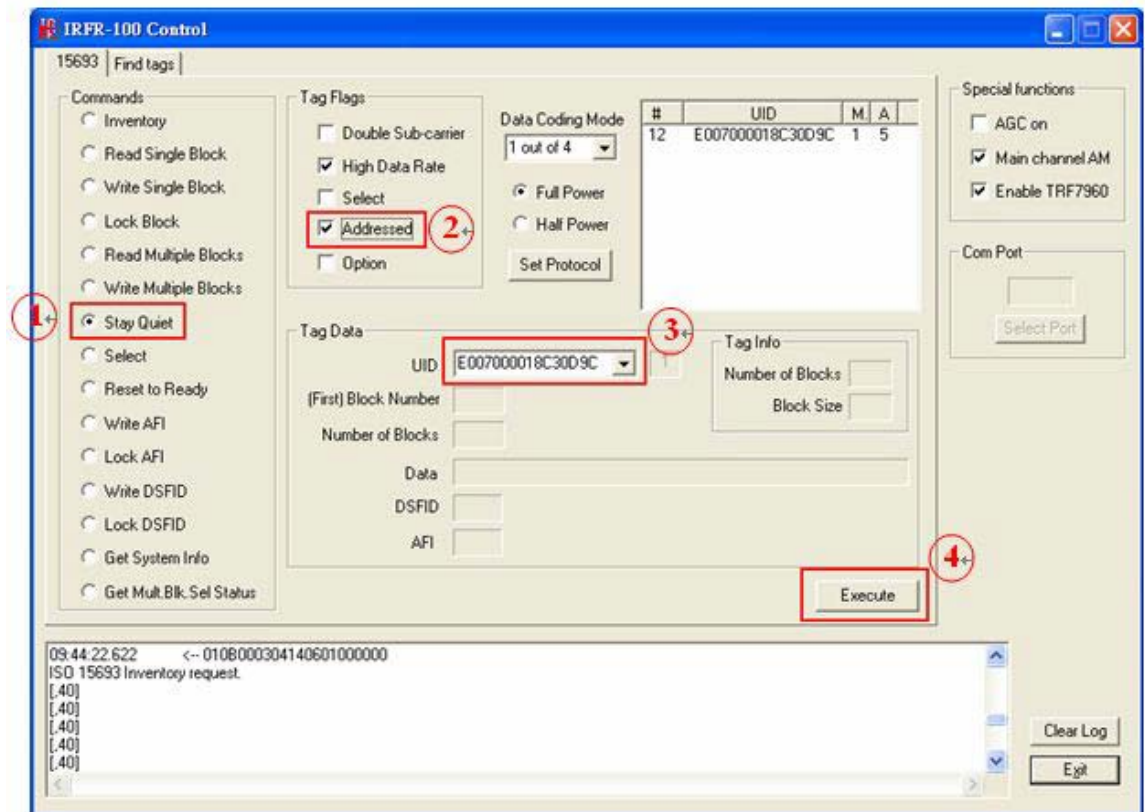

**Figure 4-16: Stay Quiet**

## AFL2-MF-RFID-KIT Series

If you want to clear *Quiet* mode, see following instructions:

- Step 1:** Click the button for *Reset to Ready* in the Commands window
- Step 2:** Click on addressed flag in the Tag Flags window
- Step 3:** Select a tag which is in *Quiet* mode from the UID pulldown list in the Tag Data window
- Step 4:** Execute the command

At last, the tag will response to any nonaddressed or inventory related commands.

### 4.5.8 Select

The Select command places the addressed tag in the Select state. In this state, it responds to requests with the ISO 15693 Select Flag set. This flag is directly controlled by the <IsSelectMsg> field present in many ISO 15693 library request messages. Any receiving tag currently in the Select state with UID not matching the value sent in the request command, exits that state and enters the Ready state but does not send a reply. (See [Appendix A](#) for more instructions)

To select a tag, the user should:

- Step 1:** Click the button for Select in the Commands window
- Step 2:** Click on any flags that must be set in the Tag Flags window
- Step 3:** Optionally select a tag from the UID pulldown list in the Tag Data window and set the Addressed flag (if only one tag is present, only one choice is available)
- Step 4:** Execute the command

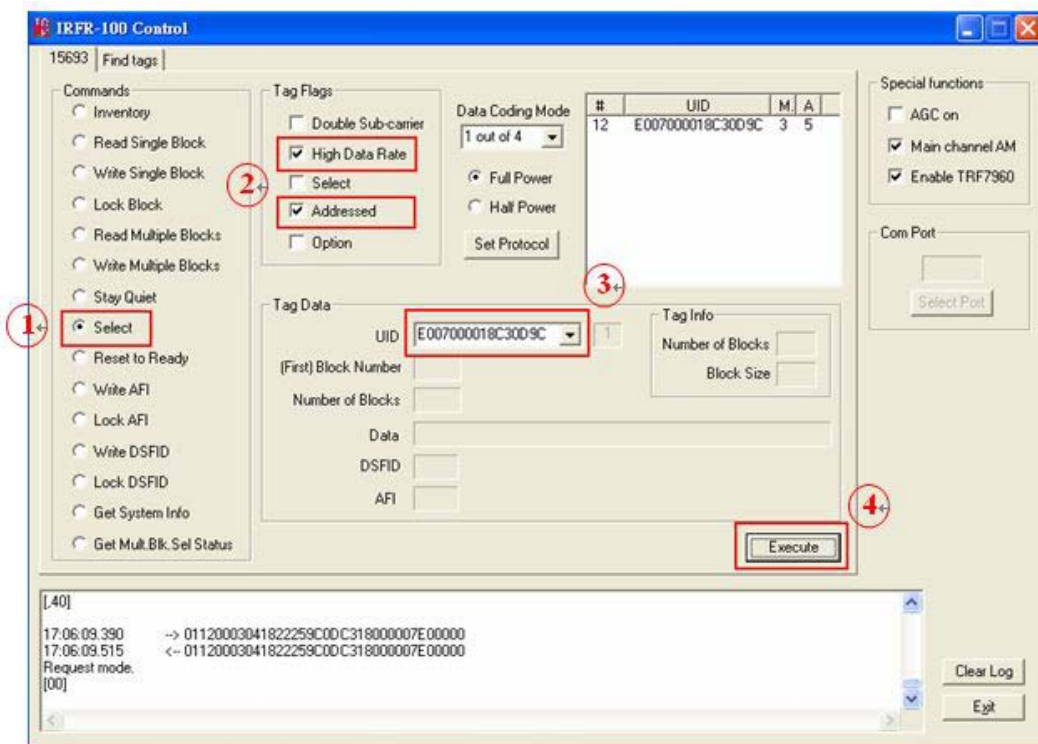

Figure 4-17: Select

#### 4.5.9 Reset to Ready

The Reset To Ready command places the addressed tag in the Ready state. In this state, it does not respond to requests with the ISO 15693 Select Tag Flags set, but to any nonaddressed request or request matching its UID.

This command is, in effect, the complement of the Select command, and undoes it.

To reset a tag, the user should:

- Step 1: Click the button for Reset to Ready in the Commands window
- Step 2: Click on any flags that must be set in the Tag Flags window
- Step 3: Optionally select a tag from the UID pulldown list in the Tag Data window (if only one tag is present, only one choice is available)
- Step 4: Execute the command

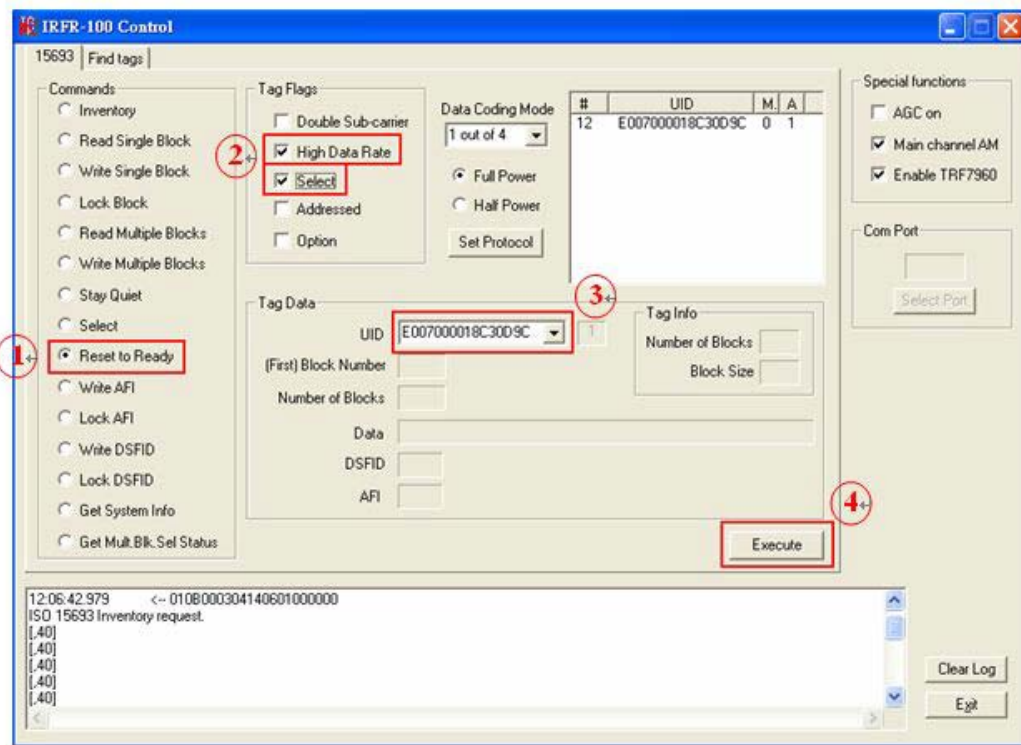

**Figure 4-18: Reset to Ready**

#### 4.5.10 Write AFI (Application Family Identifier)

The Write AFI command records a new value to the AFI register (see [Appendix B](#) for AFI codes) of the addressed tag(s). A corrupted response or lack of response from TRF7960 does not necessarily indicate a failure to perform the write operation. Additionally, multiple transponders may process a non-addressed request.

AFI represents the tag application, and is used to extract information from tags meeting the application criteria.

To write a tag's AFI, the user should:

- Step 1:** Click the button for Write AFI in the Commands window
- Step 2:** Click on any flags that must be set in the Tag Flags window

- Step 3: Optionally select a tag from the UID pulldown list in the Tag Data window (if only one tag is present only one choice is available)
- Step 4: Enter the desired AFI code in the AFI field in the Tag Data window (in hexadecimal)
- Step 5: Execute the command

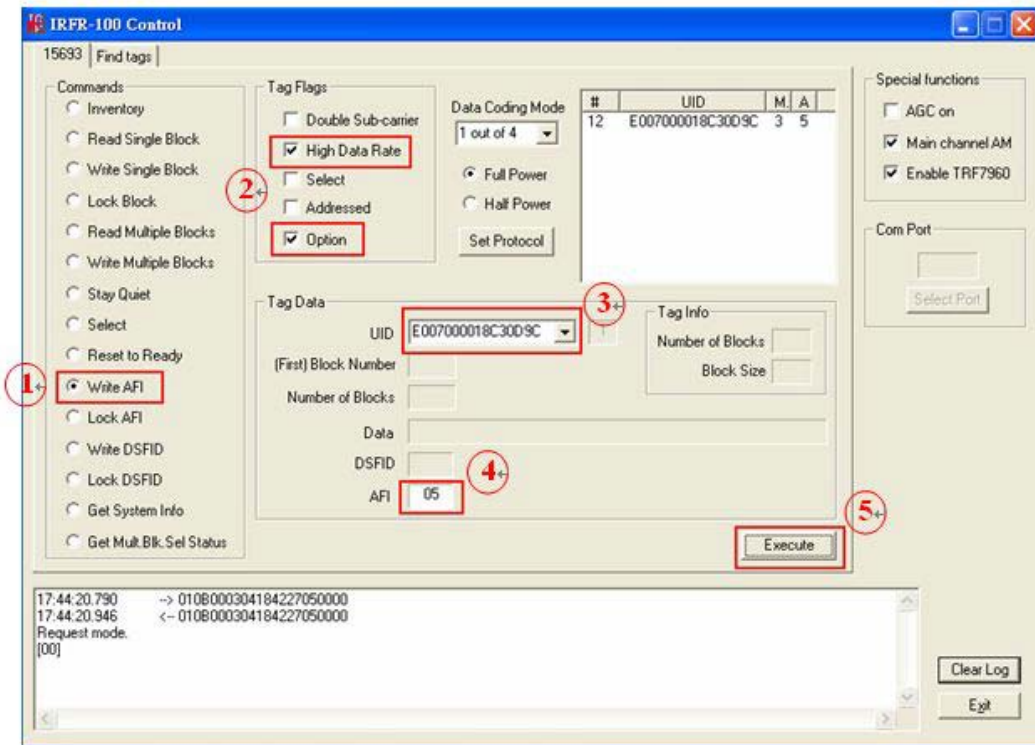

**Figure 4-19: Write AFI**



**NOTE:**

The **Option flag** (bit 7) of the ISO 15693 defined Request flags must be set to 1 for all Write and Lock commands to respond properly.

AFL2-MF-RFID-KIT Series

4.5.11 Lock AFI (Application Family Identifier)

The Lock AFI command write-protects the AFI register of the addressed tag(s). A corrupted response or lack of response does not necessarily indicate a failure to perform the lock operation. Additionally, multiple transponders may process a nonaddressed request.

**Used to permanently lock the AFI.**

To a lock tag's AFI, the user should:

- Step 1: Click the button for Lock AFI in the Commands window
- Step 2: Click on any flags that must be set in the Tag Flags window
- Step 3: Optionally select a tag from the UID pulldown list in the Tag Data window (if only one tag is present, only one choice is available)
- Step 4: Execute the command

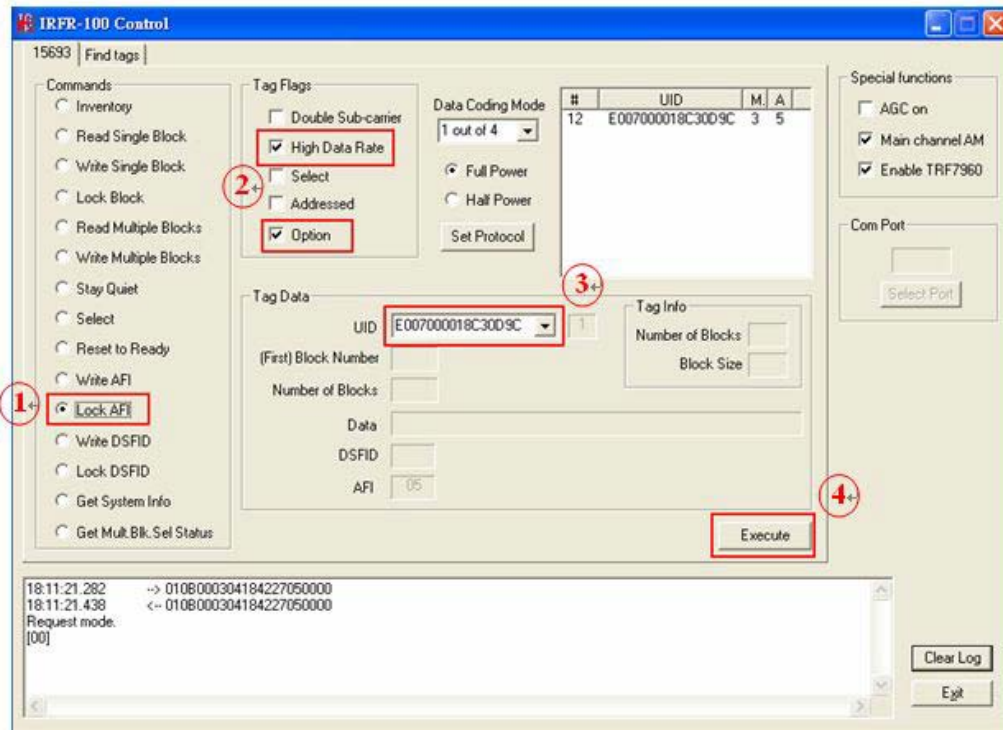

Figure 4-20: Lock AFI

**NOTE:**

The **Option flag** (bit 7) of the ISO 15693 defined Request flags must be set to 1 for all Write and Lock commands to respond properly.

---

#### 4.5.12 Write DSFID (Data Storage Format ID)

The Write DSFID (data storage format ID) command writes a new value in the DSFID register of the addressed tag(s). A corrupted response or lack of response from the TRF7960 does not necessarily indicate a failure to perform the write operation. Additionally, multiple transponders may process a nonaddressed request.

To write a tag's DSFID, the user should:

- Step 1:** Click the button for Write DSFID in the Commands Window
- Step 2:** Click on any flags that must be set in the Tag Flags window
- Step 3:** Select a tag from the UID pulldown list in the Tag Data window (if only one tag is present, only one choice is available)
- Step 4:** Enter the desired DSFID code in the DSFID field in the Tag Data window (in hexadecimal)
- Step 5:** Execute the command

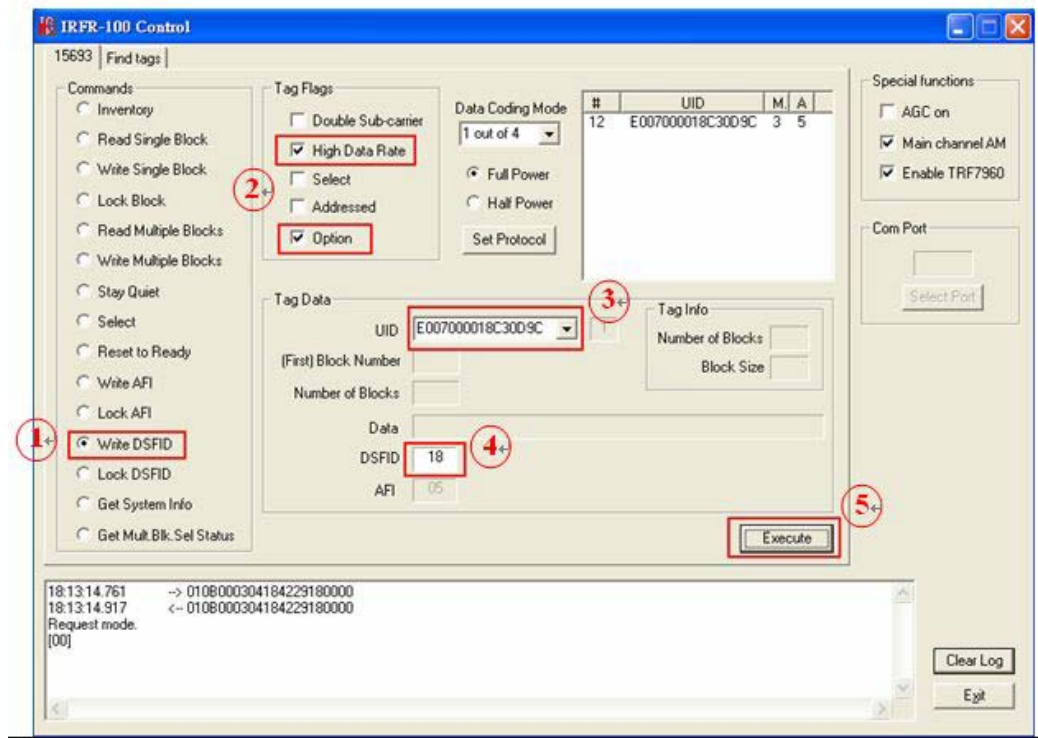

Figure 4-21: Write DSFID



**NOTE:**

The **Option flag** (bit 7) of the ISO 15693 defined Request flags must be set to 1 for all Write and Lock commands to respond properly.

#### 4.5.13 Lock DSFID (Data Storage Format ID)

The Lock DSFID command write-protects the DSFID register of the addressed tag(s). A corrupted response or lack of response from TRF7960 does not necessarily indicate a failure to perform the lock operation. Additionally, multiple transponders may process a nonaddressed request.

**Used to permanently lock the DSFID.**

To a lock tag's DSFID, the user should:



- Step 1: Click the button for Lock DSFID in the Commands window
- Step 2: Click on any flags that must be set in the Tag Flags window
- Step 3: Optionally select a tag from the UID pulldown list in the Tag Data window (if only one tag is present, only one choice is available)
- Step 4: Execute the command

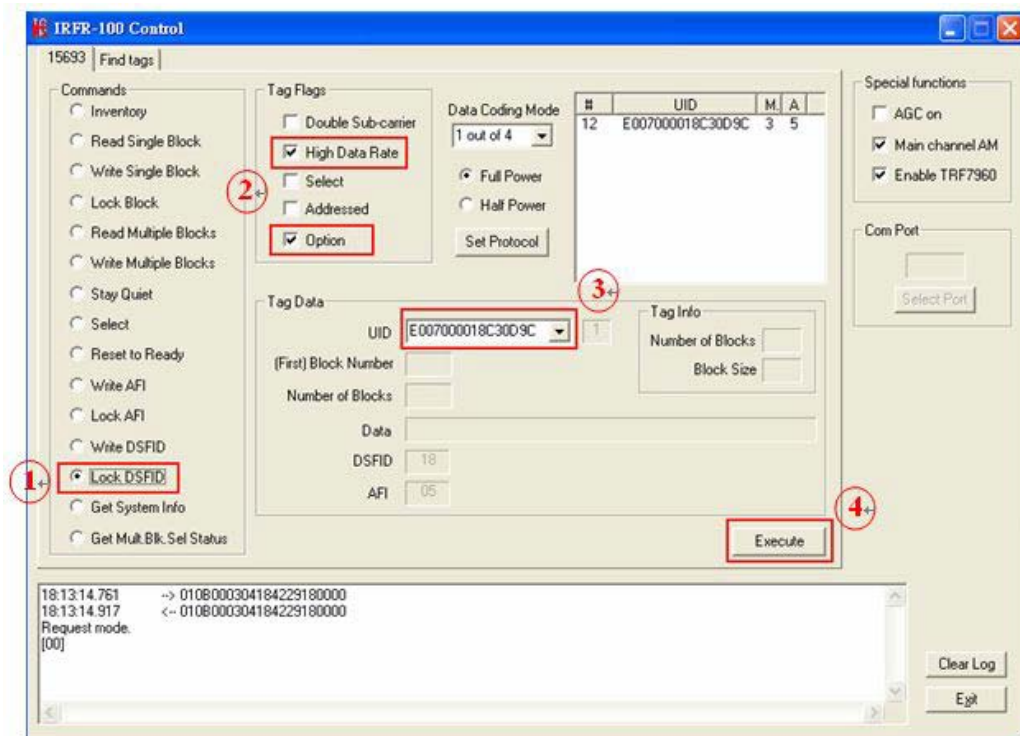

Figure 4-22: Lock DSFID



**NOTE:**

The **Option flag** (bit 7) of the ISO 15693 defined Request flags must be set to 1 for all Write and Lock commands to respond properly.

## AFL2-MF-RFID-KIT Series

### 4.5.14 Get System Info

The Get System Info command retrieves identification, application family, data formatting, and memory block sizes as specified in the ISO 15693 standard (if tag supports this command).

To get system information, the user should:

- Step 1:** Click the button for Get System Info in the Commands window
- Step 2:** Click on any flags that must be set in the Tag Flags window
- Step 3:** Optionally select a tag from the UID pulldown list in the Tag Data window (if only one tag is present, only one choice is available)
- Step 4:** Execute the command

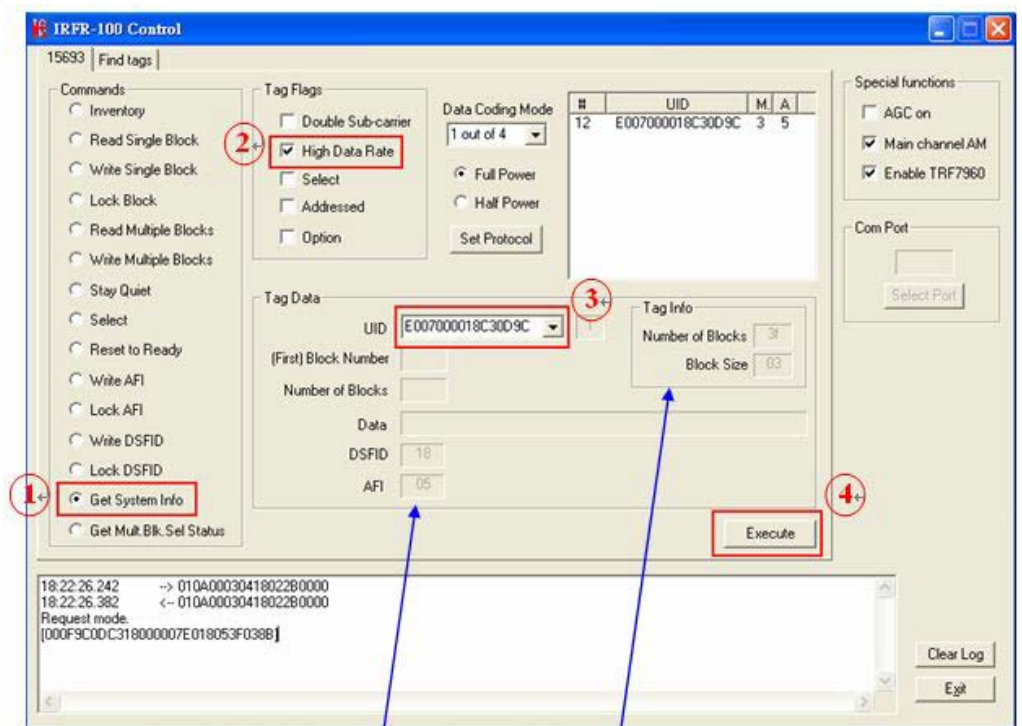

DSFID: 18  
AFI: 05

Number of Blocks: 3f ( 00~3f, 64 blocks )  
Block Size: 03 ( 00~03, 4 bytes )

**Figure 4-23: Get System Info**

#### 4.5.15 Get Multiple-Block Security Status (Get Mult\_Blk Sel Status)

The Get Multiple-Block Security Status (Get Mutt. Blk. Sel Status) command gets a block security status byte for each block requested. This byte encodes the write protection of the block specified (e.g., unlocked, (user/factory) locked, etc.).

To get multiple block security status, the user should:

- Step 1:** Click the button for Get Mult.Blk.Sel Status in the Commands window
- Step 2:** Click on any flags that must be set in the Tag Flags window
- Step 3:** Optionally select a tag from the UID pulldown list in the Tag Data window (if only one tag is present, only one choice is available)
- Step 4:** Enter two hex digits corresponding to the starting block number in the (First) Block Number field in the Tag Data window. The blocks are numbered from 00 to FF (0 to 255)
- Step 5:** Enter two hex digits corresponding to the number of blocks to be written in the Number of Blocks field in the Tag Data window. The number of blocks in the request is one less than the number of blocks that the tag returns in its response. E.g., a value of 06 in the Number of Blocks field requests to read 7 blocks. A value of 00 requests to read a single block
- Step 6:** Execute the command

AFL2-MF-RFID-KIT Series

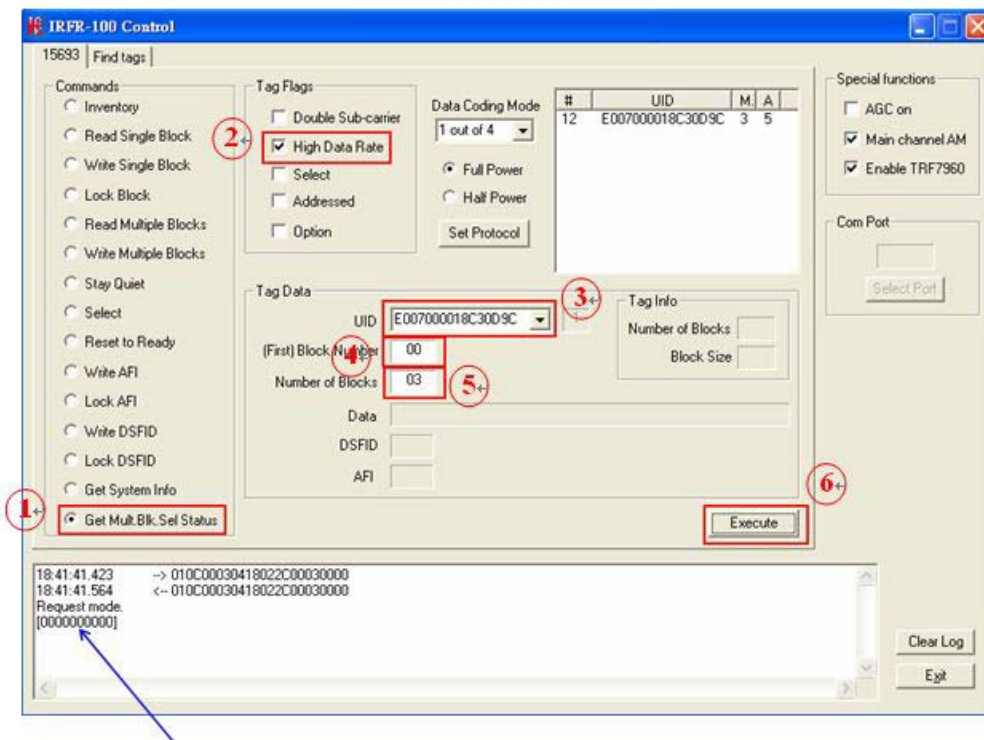

[00 00 00 00 00] : block 00-03 are all unlocked ( if tag is locked, it will response 01 )

Figure 4-24: Get Multiple-Block Security Status

## 4.6 Find Tags

The Find tags window enables the query of the RF field for all supported tags. It continuously sends an Inventory request and displays all the tag labels found within the read range of the reader. The user can select the appropriate buttons that correspond to the protocol field.

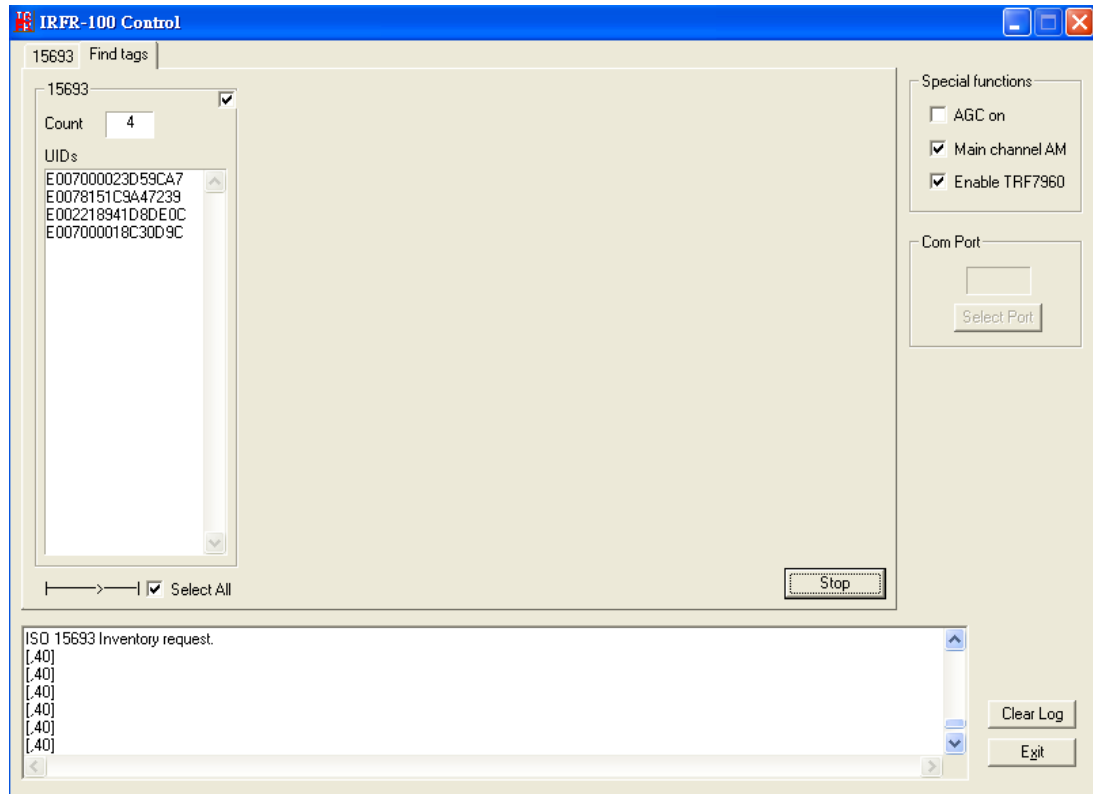

**Figure 4-25:**

Once the Run button is clicked, the window shows all tags found within its reception area.

This command runs until the Stop button is clicked (shared location with the Run button). An indicator for the supported standards is active when the particular protocol is running. This moving right cursor can be found located left of the Select All button.

This command is recommended for demonstrations, as it requires no specific knowledge of commands/flags for each protocol.

Appendix

A

# Multiple Tags Writing Instruction

---

## A.1 Inventory Request

With the Inventory request, all the UIDs from the tags in the reader field are displayed.

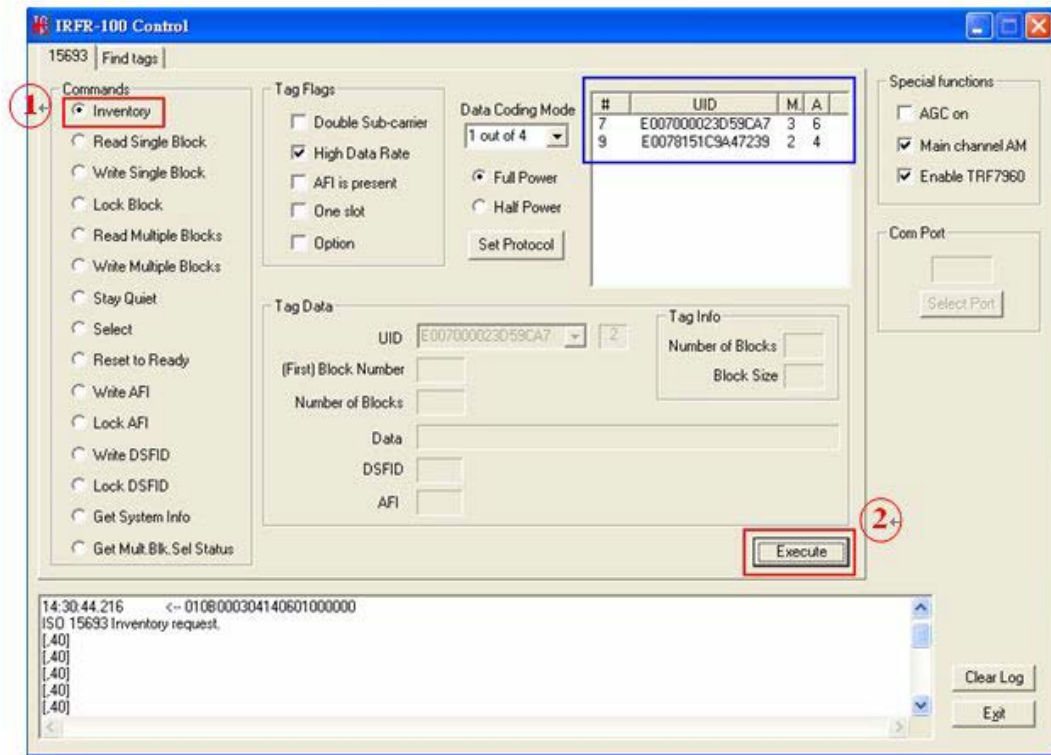

## A.2 NON - ADDRESSED Mode

In NON-ADDRESSED mode, users can write data to multiple tags at one time.

- Needn't choosing the UID of the tag
- Un-check the 'Addressed' flag
- Check the 'Option' flag

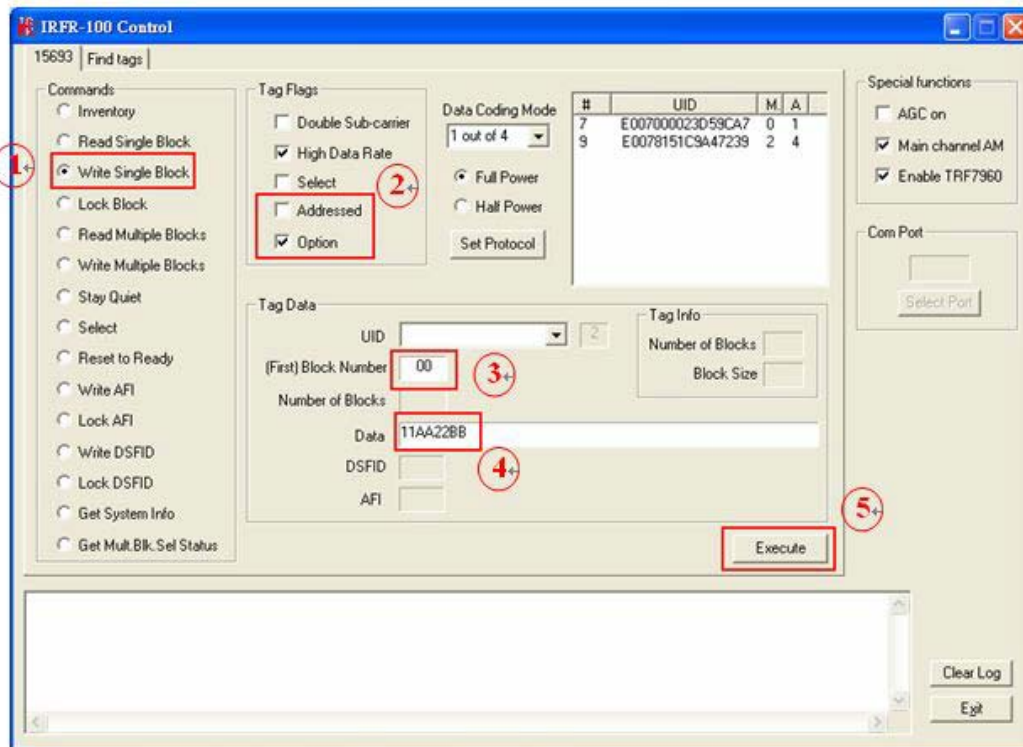

### A.3 ADDRESSED Mode

In ADDRESSED mode, you can write data to a specific tag.

- Choose the UID of the tag
- Check the 'Addressed' flag
- Check the 'Option' flag



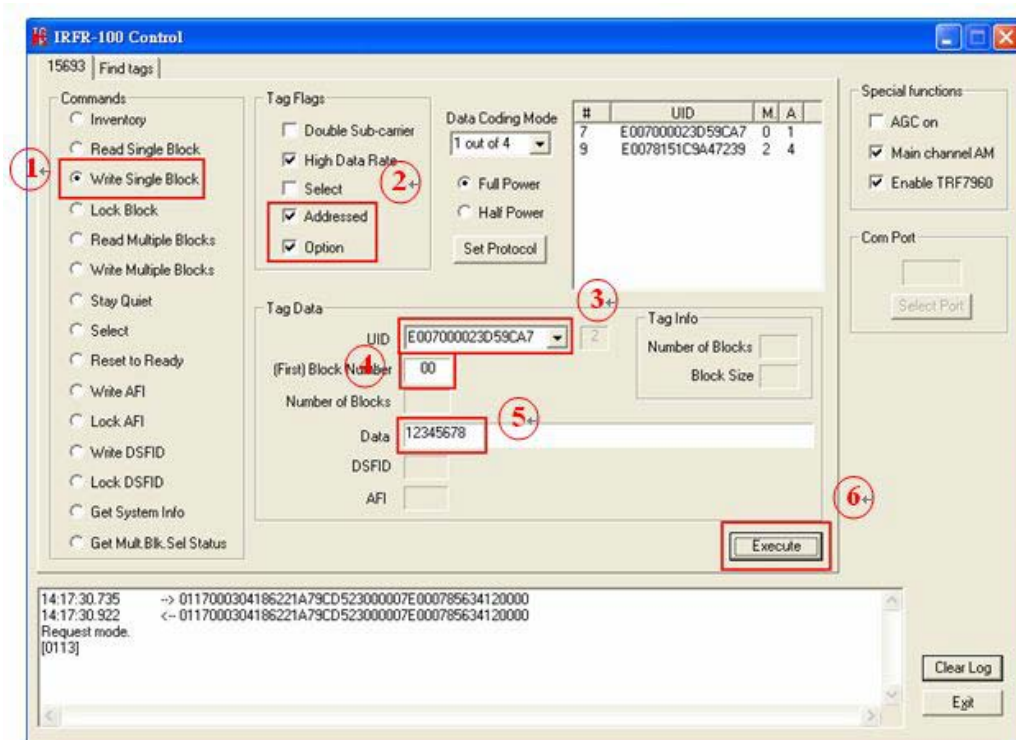

Reading back the written data from a specific tag:

- The 'Addressed' flag has to be selected
- The 'Option' flag is optional

If the "Option" flag is set, then the last two digits (when a Read single block is executed) will designate whether the tag is **unlocked (00)** or **locked (01)**):

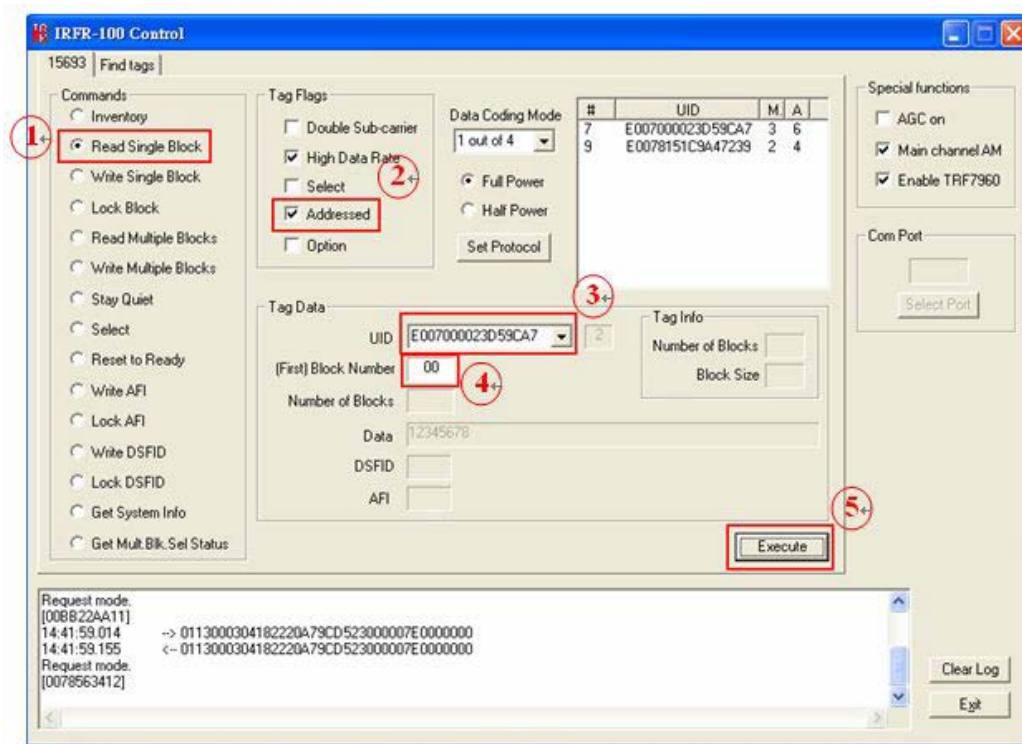

## A.4 SELECTED Mode

Setting a tag in selected state:

- Choose 'Select' command
- The 'Addressed' flag has to be set
- Choose the UID of the preferred tag

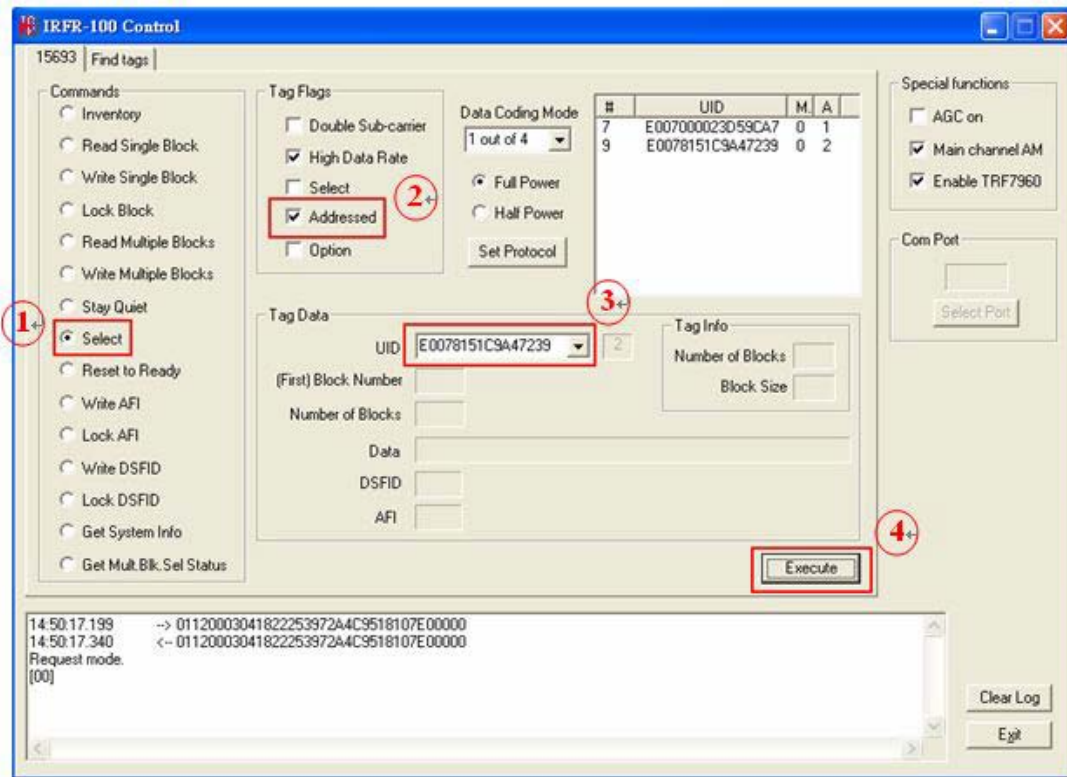

When a tag is set in **selected state**, all other requests will not need to choose its UID.

Writing data to a tag, which is in **selected state**:

- The 'Select' flag has to be set
- Check the 'Option' flag

# AFL2-MF-RFID-KIT Series

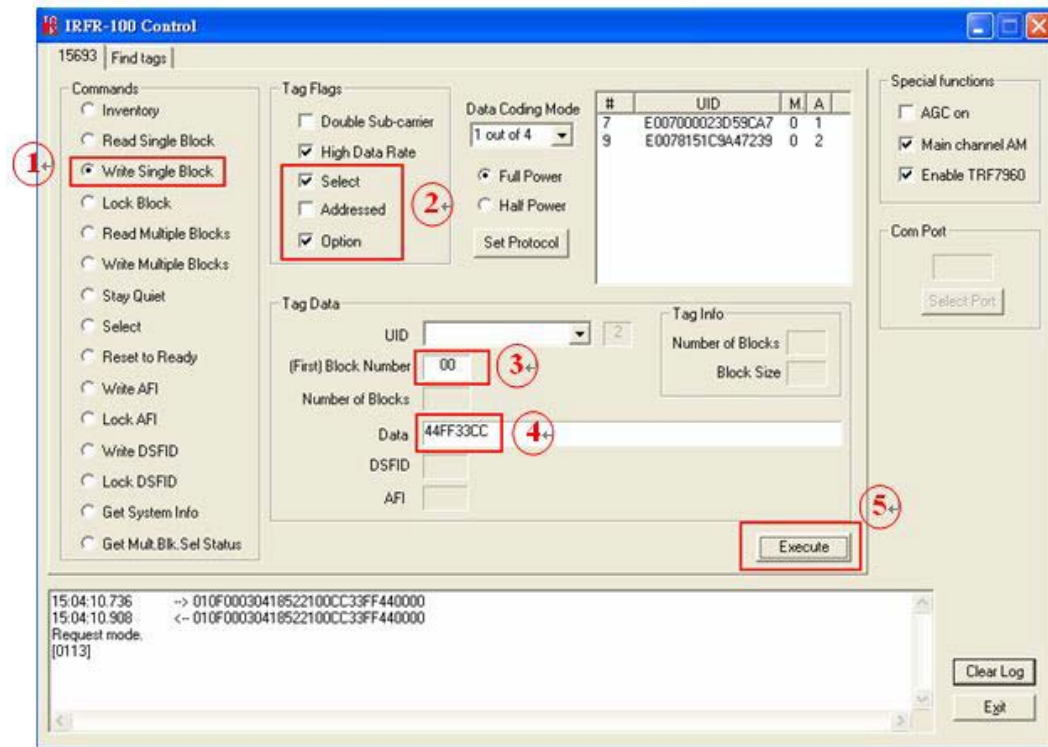

Reading data from a selected tag:

- The 'Select' flag has to be set

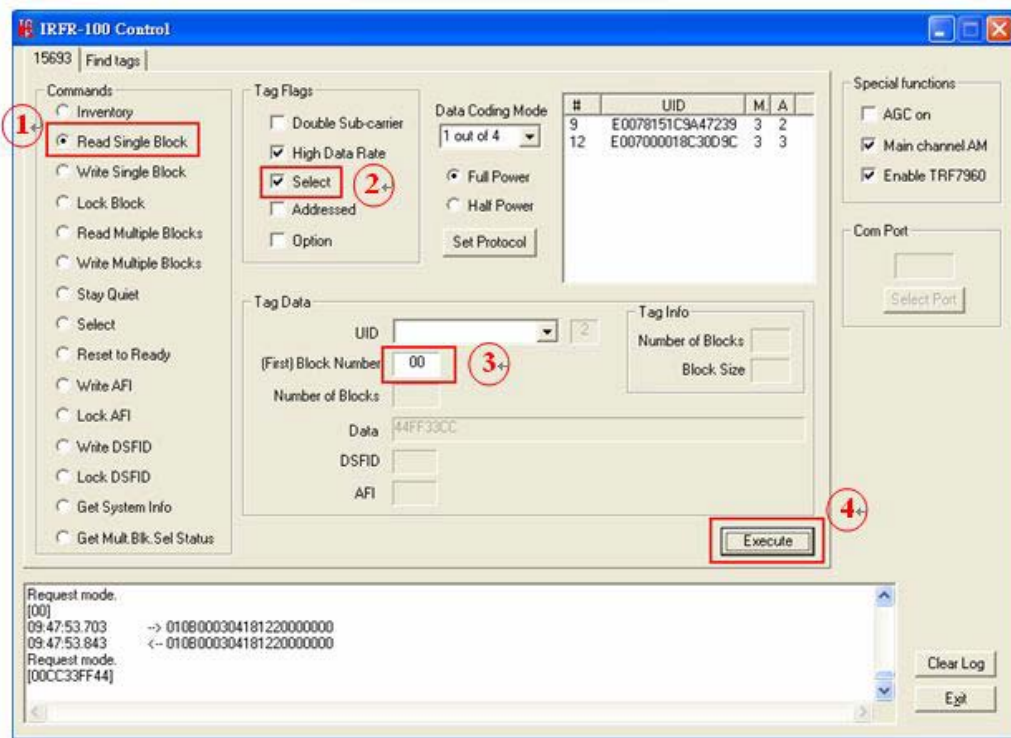

If we want to select the second tag, the first tag (the one in the [selected state](#)) has to be deselected first.

To deselect the first tag:

- The 'Select' flag has to be set

AFL2-MF-RFID-KIT Series

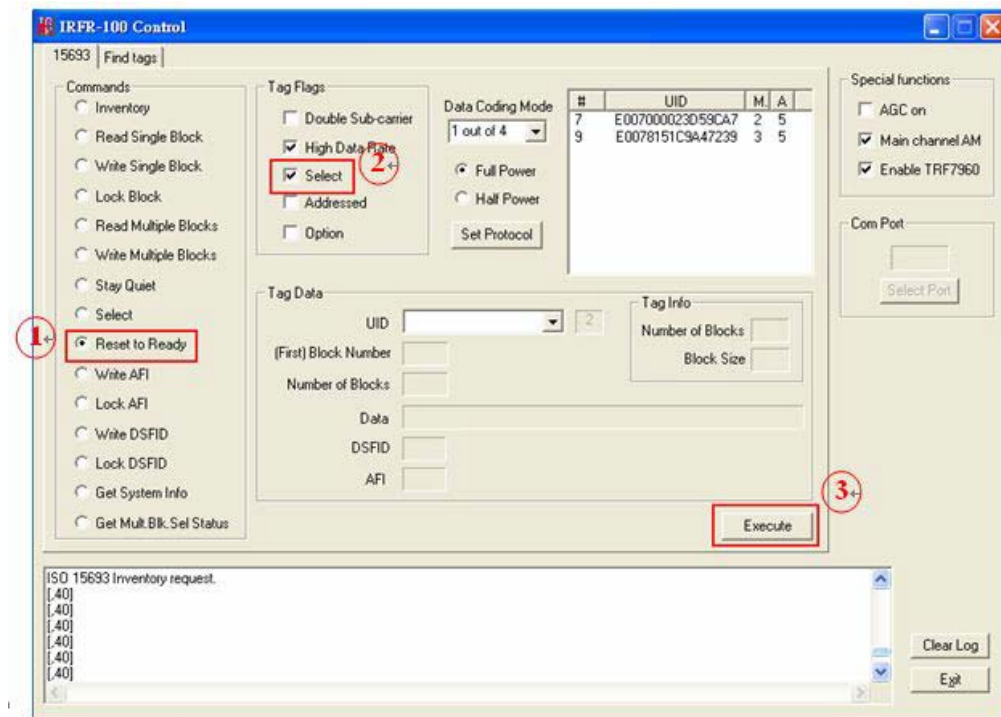

Setting the second tag in selected state, please return to follow the steps of [A.4](#).

Appendix

**B**

# TestDII Program

---

## B.1 Introduction

This document provides the information for application developer to understand the IRFR-100 - TestDll Program architecture and application programming reference. The demo program is developed by using Microsoft Visual Studio .NET 2003. MFC library. And the demo program for WinCE is developed by Microsoft eMbedded Visual C++ 4.0 MFC library.

## B.2 How to use

Before you can utilize the IRFR-100 software application programming interface, you have to do some basic initialization. The SDK package includes one dynamic link library named "IRFR\_100\_DLL.dll". You need to include "IRFR\_100\_DLL.h" in your application header file and set "IRFR\_100\_DLL.lib" in project linker input, then you can use its APIs.

IRFR\_100\_TestDll\_C.rar will demonstrate how to use IRFR\_100\_DLL\_C library.

IRFR-100-TestDll Application Architecture :

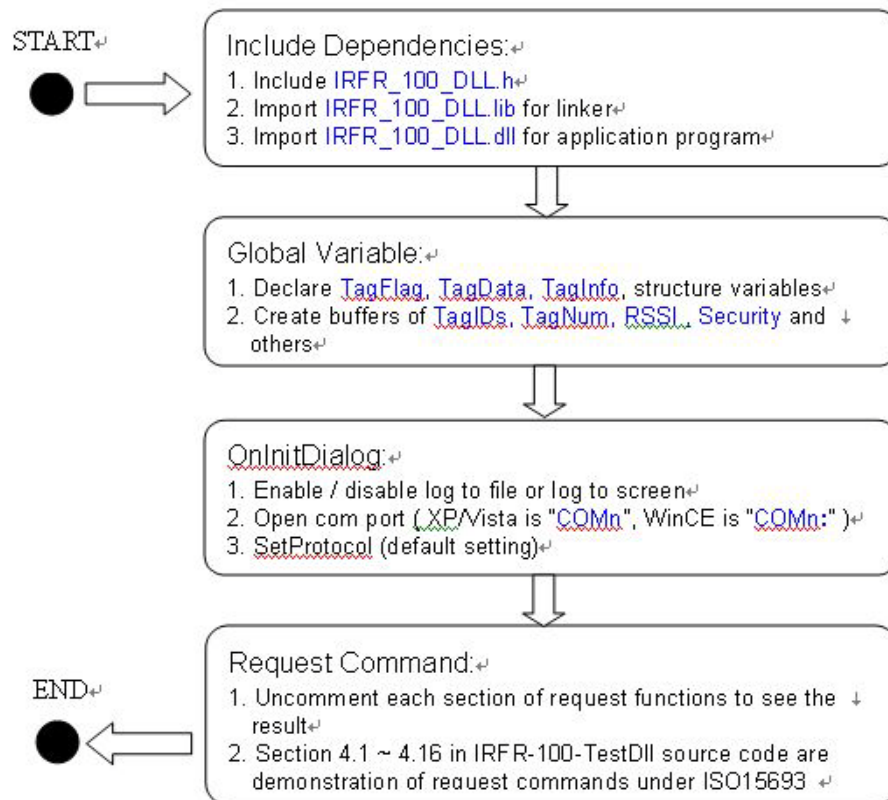



### B.3 Tag Information Structure

The data structure contains all information about RFID Tag. Below are the declarations of TagFlag, TagData, TagInfo, RSSI and the description of entries.

#### B.3.1 Tag Flag

```

struct tagflag {
    int t15CodingMode;
    int t15bSubCarrier;
    int t15bDataRate;
    int t15bInventory;
    int t15bSelect;
    int t15bAddress;
    int t15bOption;
    int t15iFullPower;
};
typedef struct tagflag TagFlag;
    
```

Variable	Description	
	Value = 0	Value = 1
t15CodingMode	1 out of 4	1 out of 256
t15bSubCarrier	single sub-carrier	double sub-carrier
t15bDataRate	low data rate	high data rate
t15bInventory	other request	inventory request
t15bSelect	disable select mode	enable select mode
t15bAddress	non-addressed mode	addressed mode
t15bOption	disable option	enable option
t15iFullPower	full power	half power

#### B.3.2 Tag Data

```

Struct tagdata{
    
```

## AFL2-MF-RFID-KIT Series

```

char t15UID [CMD_LEN];
char t15FirstBN [HEX_LEN];
char t15NumBl [HEX_LEN];
char t15Data [CMD_LEN];
char t15DSFID [DSFID_LEN];
char t15AFI [HEX_LEN];
};
typedef struct tagdata TagData;

```

Variable	Description	
t15UID	Tag UID	CMD_LEN = 2048
t15FirstBN	First block number	HEX_LEN = 4
t15NumBl	Number of Blocks	HEX_LEN = 4
t15Data	Block data	CMD_LEN = 2048
t15DSFID	DSFID number	DSFID_LEN = 4
t15AFI	AFI number	HEX_LEN = 4

### B.3.3 Tag Info

```

struct taginfo{
char DSFID [DSFID_LEN];
char AFI [HEX_LEN];
char NumofBlk [HEX_LEN];
char BlkSize [HEX_LEN];
};
typedef struct taginfo TagInfo;

```

Variable	Description	
DSFID	DSFID number	DSFID_LEN = 4
AFI	AFI number	HEX_LEN = 4
NumofBlk	Number of Blocks	HEX_LEN = 4

BlkSize	Block size	HEX_LEN = 4
---------	------------	-------------

### B.3.4 RSSI

```

struct rssi{
    char Slot [BUF_LEN];
    char UID [CMD_LEN];
    char AM [BUF_LEN];
    char PM [BUF_LEN];
};
typedef struct rssi RSSI;
    
```

Variable	Description	
Slot	Slot number (1 ~ 16)	BUF_LEN = 36
UID	Tag UID	CMD_LEN = 2048
AM	Main channel	BUF_LEN = 36
PM	Sub channel	BUF_LEN = 36

### B.3.5 Request Command Type

These are definitions of request command type used by **IRFR\_RequestExecute()** function

```

#define INVENTORY      0
#define READ_SB       1
#define WRITE_SB      2
#define LOCK_B        3
#define READ_MB       4
#define WRITE_MB      5
#define QUIET         6
#define SELECT        7
#define READY         8
#define WRITE_AFI     9
#define LOCK_AFI     10
#define WRITE_DSFD   11
#define LOCK_DSFD    12
    
```

## AFL2-MF-RFID-KIT Series

```
#define SYSTEM_INFO    13
#define MBS_STATUS     14
```

## B.4 Software APIs

```
BOOL IRFR_FindPort ( void )
```

This function can be used to find com port and open it automatically.

[ Parameter ]

None.

[ Return ]

If open IRFR-100 device com port successfully, it return 1, otherwise return 0.

Example :

```
IRFR_FindPort ();
```

```
BOOL IRFR_FindSinglePort ( char *Port )
```

This function can be used to open com port manually.

[ Parameter ]

`char * Port` : assign IRFR-100 device com port name.

[ Return ]

If open IRFR-100 device com port successfully, it return 1, otherwise return 0.

Example :

```
XP/Vista : BOOL IRFR_FindSinglePort ( "COM4" );
```

```
WinCE:    BOOL IRFR_FindSinglePort ( "COM4:" );
```

```
int IRFR_logAddFile ( char * msg )
```

This function can be used to write string to user defined log file. Remember to call **IRFR\_SetFilePath()** to set log file pathname first.

[ Parameter ]

`char * msg` : assign user defined string.

[ Return ]

If write string successfully, it return 0, otherwise return 1 (NULL\_FILE\_PATH).

Example :

```
IRFR_logAddFile ( "Com Port Found!!" );
```

```
Int IRFR_logAddScreen ( char * msg )
```

This function can be used to write string to user defined MFC CEdit control variable and show it on the screen. Remember to call **IRFR\_SetLogger()** to set CEdit control variable first.

[ Parameter ]

`char * msg` : assign user defined string.

[ Return ]

If write string successfully, it return 0, otherwise return 2 (NULL\_LOGGER).

Example :

```
IRFR_logAddScreen ( "Com Port Found!!" );
```

```
void IRFR_SetFilePath ( char * path )
```

This function can be used to set log file pathname.

[ Parameter ]

`char * path` : assign user defined file pathname.

[ Return ]

## AFL2-MF-RFID-KIT Series

None.

Example :

```
IRFR_SetFilePath ( "TestDII.log" );
```

```
void IRFR_SetLogger ( CEdit *logger )
```

This function can be used to set MFC CEdit control variable.

[ Parameter ]

CEdit \*logger : assign user defined CEdit control variable.

[ Return ]

None.

Example :

```
IRFR_SetLogger ( &m_myLogger );
```

```
void IRFR_SetLogFile ( bool result )
```

This function can be used to enable or disable log to file feature.

[ Parameter ]

bool result : assign **true** to enable log to file feature, or **false** to disable it.

[ Return ]

None.

Example :

```
IRFR_SetLogFile ( false );
```

```
void IRFR_SetLogScreen ( bool result )
```

This function can be used to enable or disable log to screen feature.

[ Parameter ]

bool result : assign **true** to enable log to screen feature, or **false** to disable it.

[ Return ]

None.

Example :

```
IRFR_SetLogScreen ( false );
```

```
void IRFR_ClearLog ( void );
```

This function can be used to clear CEdit control variable buffer and clear screen data.

[ Parameter ]

None.

[ Return ]

None.

Example :

```
IRFR_ClearLog ();
```

```
int IRFR_SetProtocol ( TagFlag tf );
```

This function can be used to set or update operation flags of IRFR-100 device.

[ Parameter ]

TagFlag tf : assign user defined TagFlag structure.

[ Return ]

If success, return 0, otherwise return 1.

Example :

## AFL2-MF-RFID-KIT Series

```

m_tf -> t15CodingMode = 0;           // 1 out of 4
m_tf -> t15bSubCarrier = 0;         // single sub carrier
m_tf -> t15bDataRate = 1;           // high data rate
m_tf -> t15bInventory = 1;          // inventory request
m_tf -> t15bSelect = 0;             // disable select mode
m_tf -> t15bAddress = 0;            // non-addressed mode
m_tf -> t15bOption = 0;             // disable option
m_tf -> t15iFullPower = 0;          // 0:enable full power, 1:half power

```

```
IRFR_SetProtocol ( *m_tf );
```

```
int IRFR_RequestExecute ( int cmdno, char *reply, TagFlag tf, TagData
*td )
```

This function can be used to execute request command of ISO 15693. And IRFR-100 response data will be saved in reply buffer.

## [ Parameter ]

**int** cmdno : assign request command type.

**char** \*reply : assign user defined buffer to save data responded from IRFR-100 device.

TagFlag tf : assign user defined TagFlag structure.

TagData \*td : assign user defined TagData structure.

## [ Return ]

If success, return 0, otherwise return 1.

## Example :

```
IRFR_RequestExecute ( INVENTORY, m_reply, *m_tf, m_td );
```

```
void IRFR_FindRun ( char *TagIDs, char *TagNum )
```

This function can be used to find the UIDs of all tags (only ISO 15693 support) in the Antenna area automatically.

## [ Parameter ]

**char** \*TagIDs : assign user defined buffer to save all Tags UIDs.



`char *TagNum` : assign user defined buffer to save Tag number.

[ Return ]

None.

Example :

```
IRFR_FindRun ( m_TagIDs, m_TagNum );
```

`void IRFR_FindStop ( void )`

This function can be used to stop finding Tags.

[ Parameter ]

None.

[ Return ]

None.

Example :

```
IRFR_FindStop ();
```

`void IRFR_GetUIDs ( char *reply, char *TagIDs [ ], char *TagNum )`

This function can be used to parse the given reply buffer to retrieve Tag UIDs and Tag number.

[ Parameter ]

`char *reply` : assign reply buffer which contains responded data from IRFR-100 device.

`char *TagIDs [ ]` : assign user defined buffer to save all Tags UIDs.

`char *TagNum` : assign user defined buffer to save Tag number.

[ Return ]

None.

Example :

## AFL2-MF-RFID-KIT Series

```
IRFR_GetUIDs ( m_reply, TagIDs, TagNum );
```

Remember to call **IRFR\_RequestExecute ( INVENTORY, m\_reply, \*m\_tf, m\_td )** first to get all tags information from IRFR-100 device and save them in the reply buffer.

```
void IRFR_GetRSSI( char *reply, RSSIRSSIs [ ] )
```

This function can be used to parse the given reply buffer to retrieve RSSI information.

[ Parameter ]

**char** \*reply : assign reply buffer which contains responded data from IRFR-100 device.

RSSI RSSIs [ ] : assign user defined RSSI structure to save all Tags RSSI info.

[ Return ]

None.

Example :

```
IRFR_GetRSSI ( m_reply, RSSIs );
```

Remember to call **IRFR\_RequestExecute ( INVENTORY, m\_reply, \*m\_tf, m\_td )** first to get all tags information from IRFR-100 device and save them in the reply buffer.

```
void IRFR_GetBlockData ( char *reply, TagData *td )
```

This function can be used to parse the given reply buffer to retrieve single block data of specified block index.

[ Parameter ]

**char** \*reply : assign reply buffer which contains responded data from IRFR-100 device.

TagData \*td : assign user defined TagData structure to save block data.

[ Return ]

None.

Example :

```
IRFR_GetBlockData ( m_reply, m_td );
```

Remember to call **IRFR\_RequestExecute ( READ\_SB, m\_reply, \*m\_tf, m\_td )** first to get specified tag information from IRFR-100 device and save them in the reply buffer.

```
void IRFR_GetMultiBlockData ( char *reply, TagData *td );
```

This function can be used to parse the given reply buffer to retrieve multiple block data of specified block index range.

[ Parameter ]

**char** \*reply : assign reply buffer which contains responded data from IRFR-100 device.

TagData \*td : assign user defined TagData structure to save multiple block data.

[ Return ]

None.

Example :

```
IRFR_GetMultiBlockData ( m_reply, m_td );
```

Remember to call **IRFR\_RequestExecute ( READ\_MB, m\_reply, \*m\_tf, m\_td )** first to get specified tag information from IRFR-100 device and save them in the reply buffer.

```
void IRFR_GetTagInfo ( char *reply, TagInfo *ti, TagFlag tf, TagData td )
```

This function can be used to parse the given reply buffer to retrieve total block number and block size of specified tag.

[ Parameter ]

**char** \*reply : assign user defined buffer to save data responded from IRFR-100 device.

TagInfo \*ti : assign user defined TagInfo structure to save tag information.

TagFlag tf : assign user defined TagFlag structure.

TagData \*td : assign user defined TagData structure.

[ Return ]

None.

## AFL2-MF-RFID-KIT Series

Example :

```
IRFR_GetTagInfo ( m_reply, m_ti, *m_tf, *m_td );
```

Remember to call **IRFR\_RequestExecute ( SYSTEM\_INFO, m\_reply, \*m\_tf, m\_td )** first to get specified tag information from IRFR-100 device and save them in the reply buffer.

```
void IRFR_GetMultiBlockSecurity ( char *reply, char *SecurityData )
```

This function can be used to parse the given reply buffer to retrieve the status (lock or unlock) of multiple blocks.

[ Parameter ]

**char** \*reply : assign reply buffer which contains responded data from IRFR-100 device.

**char** \*SecurityData : assign user defined buffer to save the status of multiple blocks.

[ Return ]

None.

Example :

```
IRFR_GetMultiBlockSecurity ( m_reply, m_SecurityData );
```

Remember to call **IRFR\_RequestExecute ( MBS\_STATUS, m\_reply, \*m\_tf, m\_td )** first to get specified tag information from IRFR-100 device and save them in the reply buffer.

## B.5 Example Code

Please extract **IRFR\_100\_TestDII\_C.rar (XP/Vista)** or **IRFR\_100\_TestDII\_MFC\_CE.rar (WinCE)** in the "IRFR-100 APPLICATION SDK" package and uncomment one of section B.4 and build the project to show the demo application.

Appendix

C

# ISO/IEC 15693

## Reference Material

---

## C.1 UID Format

The tags are uniquely identified by a 64-bit unique identifier (UID). This is used for addressing each tag uniquely and individually during the anticollision loop, and for one-to-one exchange between a reader and a tag.

The format of the UID is shown below:

Bits 64 to 57	Bits 56 to 49	Bits 48 to 1
E0	Manufacturer code IC	serial number

The UID is composed of:

- The 8 MSBs, which are E0.
- The 8-bit IC manufacturer code
- A unique serial number of 48 bits assigned by the IC manufacturer

## C.2 Tag Memory Organization

Tag memory is organized into blocks of bytes. Addressing is by block only. There is no individual byte addressing for read or write; the whole block is accessed. It is analogous to a spreadsheet with rows and columns, where addressing accesses a whole row at once.

The format of tag memory is shown as follows:

Bits 16 to 14	Bits 13 to 9	Bits 8 to 1
RFU	Block size in bytes	Number of blocks

- Block size is expressed in 5 bits, allowing up to 32 bytes, i.e., 256 bits. It is one less than the actual number of bytes. E.g., a value of 1F indicates 32 bytes; a value of 00 indicates 1 byte.
- Number of blocks is defined in 8 bits, allowing up to 256 blocks. It is one less than the actual number of blocks. E.g., a value of FF indicates 256 blocks; a value of 00 indicates 1 block.
- The 3 most-significant bits are reserved for future use and are set to zero.

This addressing scheme limits the total storage of the tag to 8K bytes.

### C.3 Flag Definitions

- **High Data Rate:** the default data rate is used for maximum detection range. If *High Data Rate* is selected in the *Tag Flags* window, communication with the tag is faster, but the range is reduced.
- **AFI is present:** The default setting for the AFI (Application Family Identifier) is off. If *AFI is present* is selected in the *Tag Flags* window, AFI is enabled in commands and responses.
- **One Slot:** the definition of slot, as used in the software, is the number of tags that may be received at a time. The default is 16. If only *One Slot* is selected in the *Tag Flags* window, the algorithm detects a flag sooner, but stops after detecting the first tag. Other tags in the reception range of the reader are ignored.
- **Select:** the default is off. Request executed by any tag according to the setting of *Addressed* flag. If *select* flag is selected in the *Tag Flags* window, request executed only by tag in selected state. The *Addressed* flag is set to 0 and the UID field is not included in the request.
- **Addressed:** the default setting is off. Request is not addressed. UID field is not included. It can be executed by any tag. If *addressed* flag is selected in the *Tag Flags* window, request is addressed. UID field is included. It is executed only by the tag whose UID matches the UID specified in the request.
- **Option:** *Meaning is defined by the command description.*

### C.4 Application Family Identifier (AFI) Definitions

AFI Most Significant Nibble	AFI Least Significant Nibble	Meaning Tags Respond From	Examples/Note
0	0	All families and subfamilies	No applicable reselection
X	0	All subfamilies of family X	Wide applicable preselection
X	Y	Only the Yth subfamily of family X	
0	Y	Proprietary subfamily Y only	
1	0, Y	Transport	Mass transit, bus, airline
2	0, Y	Financial	IEP, banking, retail

## AFL2-MF-RFID-KIT Series

3	0, Y	Identification	Access control
4	0, Y	Telecommunication	Public telephony, GSM
5	0, Y	Medical	
6	0, Y	Multimedia	Internet services
7	0, Y	Gaming	
8	0, Y	Data storage	Portable files
9	0, Y	Item management	
A	0, Y	Express parcels	
B	0, Y	Postal services	
C	0, Y	Airline bags	
D	0, Y	RFU	Reserved for future use
E	0, Y	RFU	Reserved for future use
F	0, Y	RFU	Reserved for future use



Appendix

D

# Hazardous Materials Disclosure

---

## D.1 Hazardous Materials Disclosure Table for IPB Products Certified as RoHS Compliant Under 2002/95/EC Without Mercury

The details provided in this appendix are to ensure that the product is compliant with the Peoples Republic of China (China) RoHS standards. The table below acknowledges the presences of small quantities of certain materials in the product, and is applicable to China RoHS only.

A label will be placed on each product to indicate the estimated “Environmentally Friendly Use Period” (EFUP). This is an estimate of the number of years that these substances would “not leak out or undergo abrupt change.” This product may contain replaceable sub-assemblies/components which have a shorter EFUP such as batteries and lamps. These components will be separately marked.

Please refer to the table on the next page.

Part Name	Toxic or Hazardous Substances and Elements					
	Lead (Pb)	Mercury (Hg)	Cadmium (Cd)	Hexavalent Chromium (CR(VI))	Polybrominated Biphenyls (PBB)	Polybrominated Diphenyl Ethers (PBDE)
Housing	X	O	O	O	O	X
Display	X	O	O	O	O	X
Printed Circuit Board	X	O	O	O	O	X
Metal Fasteners	X	O	O	O	O	O
Cable Assembly	X	O	O	O	O	X
Fan Assembly	X	O	O	O	O	X
Power Supply Assemblies	X	O	O	O	O	X
Battery	O	O	O	O	O	O

O: This toxic or hazardous substance is contained in all of the homogeneous materials for the part is below the limit requirement in SJ/T11363-2006

X: This toxic or hazardous substance is contained in at least one of the homogeneous materials for this part is above the limit requirement in SJ/T11363-2006

## AFL2-MF-RFID-KIT Series

此附件旨在确保本产品符合中国 RoHS 标准。以下表格标示此产品中某有毒物质的含量符合中国 RoHS 标准规定的限量要求。

本产品上会附有“环境友好使用期限”的标签，此期限是估算这些物质“不会有泄漏或突变”的年限。本产品可能包含有较短的环境友好使用期限的可替换元件，像是电池或灯管，这些元件将会单独标示出来。

部件名称	有毒有害物质或元素					
	铅 (Pb)	汞 (Hg)	镉 (Cd)	六价铬 (CR(VI))	多溴联苯 (PBB)	多溴二苯 醚 (PBDE)
壳体	X	O	O	O	O	X
显示	X	O	O	O	O	X
印刷电路板	X	O	O	O	O	X
金属螺帽	X	O	O	O	O	O
电缆组装	X	O	O	O	O	X
风扇组装	X	O	O	O	O	X
电力供应组装	X	O	O	O	O	X
电池	O	O	O	O	O	O

O: 表示该有毒有害物质在该部件所有物质材料中的含量均在 SJ/T11363-2006 标准规定的限量要求以下。  
X: 表示该有毒有害物质至少在该部件的某一均质材料中的含量超出 SJ/T11363-2006 标准规定的限量要求。

## Данный компонент на территории Российской Федерации

### Вы можете приобрести в компании MosChip.

Для оперативного оформления запроса Вам необходимо перейти по данной ссылке:

<http://moschip.ru/get-element>

Вы можете разместить у нас заказ для любого Вашего проекта, будь то серийное производство или разработка единичного прибора.

В нашем ассортименте представлены ведущие мировые производители активных и пассивных электронных компонентов.

Нашей специализацией является поставка электронной компонентной базы двойного назначения, продукции таких производителей как XILINX, Intel (ex.ALTERA), Vicor, Microchip, Texas Instruments, Analog Devices, Mini-Circuits, Amphenol, Glenair.

Сотрудничество с глобальными дистрибьюторами электронных компонентов, предоставляет возможность заказывать и получать с международных складов практически любой перечень компонентов в оптимальные для Вас сроки.

На всех этапах разработки и производства наши партнеры могут получить квалифицированную поддержку опытных инженеров.

Система менеджмента качества компании отвечает требованиям в соответствии с ГОСТ Р ИСО 9001, ГОСТ РВ 0015-002 и ЭС РД 009

### Офис по работе с юридическими лицами:

105318, г.Москва, ул.Щербаковская д.3, офис 1107, 1118, ДЦ «Щербаковский»

Телефон: +7 495 668-12-70 (многоканальный)

Факс: +7 495 668-12-70 (доб.304)

E-mail: [info@moschip.ru](mailto:info@moschip.ru)

Skype отдела продаж:

moschip.ru

moschip.ru\_4

moschip.ru\_6

moschip.ru\_9