



## Features

- Push switch option
- Compact, rugged design
- High reliability
- Metal bushing/shaft



## PEC09 Series - 9 mm Incremental Encoder

### Electrical Characteristics

Output.....	2-bit quadrature code
Closed Circuit Resistance.....	3 ohms maximum
Contact Rating.....	10 mA @ 5 VDC
Insulation Resistance.....	100 megohms @ 250 VDC
Dielectric Withstanding Voltage	
Sea Level.....	300 VAC minimum
Electrical Travel.....	Continuous
Contact Bounce (15 RPM).....	5.0 ms maximum**
RPM (Operating).....	60 maximum**

### Environmental Characteristics

Operating Temperature Range.....	-10 °C to +70 °C (+14 °F to +158 °F)
Storage Temperature Range.....	-40 °C to +85 °C (-40 °F to +185 °F)
Humidity.....	MIL-STD-202, Method 103B, Condition B
Rotational Life.....	30,000 cycles minimum
IP Rating.....	IP 40

### Mechanical Characteristics

Mechanical Angle.....	360 ° continuous
Torque	
Running/Detent.....	30 to 200 gf.cm (0.42 to 2.7 oz.-in.)
Mounting.....	10.0 kgf.cm (8.67 lb.-in.) maximum
Terminal Bend Strength.....	300 gf (10.6 ozf)
Shaft Push-Pull Strength.....	10 kgf (22 lbf)
Weight.....	5 gm (0.17 oz.) maximum
Terminals.....	Printed circuit board terminals
Soldering Condition	
Wave Soldering.....	Sn95.5/Ag2.8/Cu0.7 solder with no-clean flux: 260 °C max. for 3-5 seconds
Hand Soldering.....	Not recommended
Hardware.....	One flat washer and one mounting nut supplied with each encoder

### Switch Characteristics

Switch Type.....	Contact Push ON Momentary SPST
Switch Life.....	20,000 cycles minimum
Power Rating (Resistive Load).....	10 mA at 5 V DC
Switch Travel.....	See How to Order
Switch Actuation Force.....	300 ± 200 gf (10.6 ± 7.0 ozf)

### How To Order

PEC09 - 2 0 20 F - S 0012

Model.....	PEC09 - 2 0 20 F - S 0012
Terminal Configuration.....	2 = PC Pin Vertical/Side Exit
Detent Option.....	0 = No Detents (12, 15 pulses) 1 = 12 Detents (12 pulses) 2 = 24 Detents (12 pulses) 3 = 30 Detents (15 pulses)
Standard Shaft Length.....	15 = 15.0 mm 20 = 20.0 mm 25 = 25.0 mm
Shaft Style.....	F = Metal Flatted Shaft K = Metal Knurled Shaft
Switch Configuration.....	N = No Switch S = Push Momentary (0.5 mm stroke) T = Push Momentary (1.5 mm stroke)
Resolution.....	0012 = 12 Pulses per 360 ° Rotation 0015 = 15 Pulses per 360 ° Rotation

### Quadrature Output Table



### Suggested Filter Circuit



### Switch Circuit



\* RoHS Directive 2002/95/EC Jan 27, 2003 including Annex.

\*\* Devices are tested using standard noise reduction filters.

For optimum performance, designers should use noise reduction filters in their circuits.

Specifications are subject to change without notice.

Customers should verify actual device performance in their specific applications.

## Applications

Level control, tuning and timer settings in:

- Audio-visual equipment
- Consumer electric appliances
- Environmental controls
- Musical instrumentation
- Communications equipment

# PEC09 Series - 9 mm Incremental Encoder

**BOURNS®**

## Product Dimensions

### PEC09-2xxxF-Nxxxx

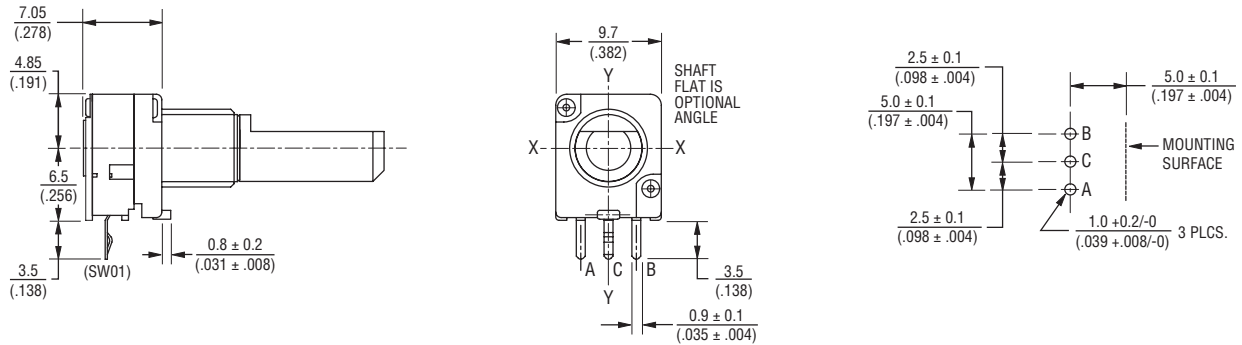

### PEC09-2xxxF-Sxxxx

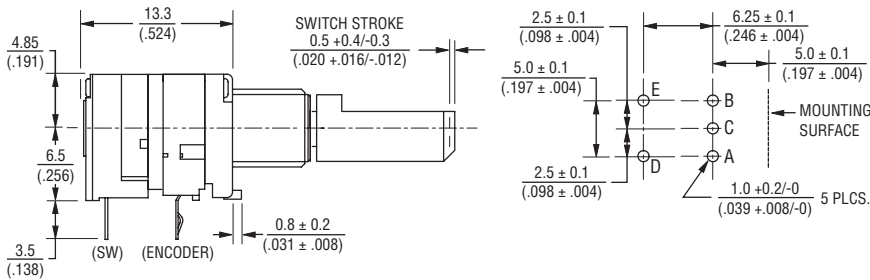

## Locating Lug Detail

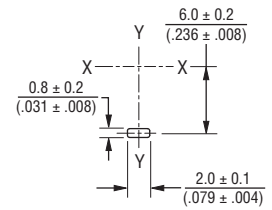

DIMENSIONS:  $\frac{\text{MM}}{\text{(INCHES)}}$

### PEC09-2xxxF-Txxxx

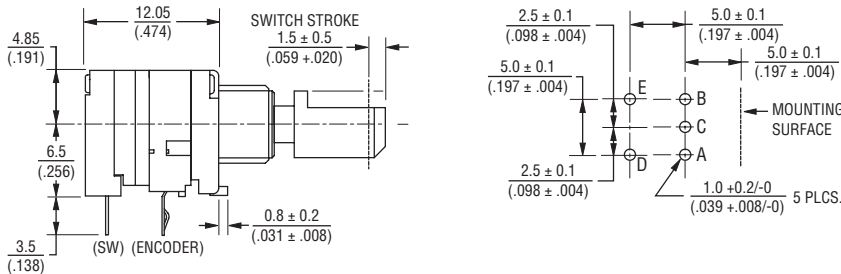

## Hardware



Specifications are subject to change without notice.  
Customers should verify actual device performance in their specific applications.

# PEC09 Series - 9 mm Incremental Encoder

# BOURNS®

## Shaft Options

### PEC09-2xxxx-Nxxxx

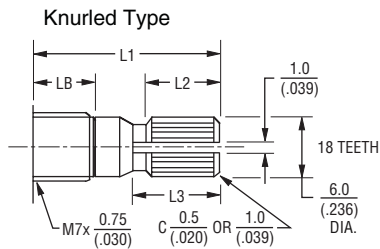

L1	LB	L2	L3
15 (.591)	5.0 (.197)	6.0 (.236)	7.0 (.276)
20 (.787)	7.0 (.276)	10.0 (.394)	11.0 (.433)
25 (.984)	10.0 (.394)	10.0 (.394)	11.0 (.433)

### PEC09-2xxxx-Sxxxx (0.5 mm Switch Stroke)

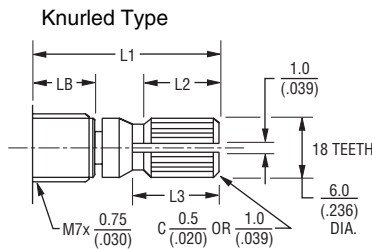

L1	LB	L2	L3
15 (.591)	5.0 (.197)	6.0 (.236)	7.0 (.276)
20 (.787)	7.0 (.276)	9.0 (.354)	10.0 (.394)
25 (.984)	10.0 (.394)	9.0 (.354)	10.0 (.394)

### PEC09-2xxxx-Txxxx (1.5 mm Switch Stroke)

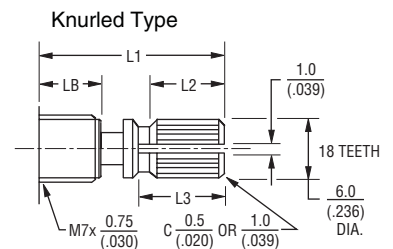

L1	LB	L2	L3
15 (.591)	5.0 (.197)	5.0 (.197)	6.0 (.236)
20 (.787)	7.0 (.276)	8.0 (.315)	9.0 (.354)
25 (.984)	10.0 (.394)	8.0 (.315)	9.0 (.354)



L1	LB	L2
15 (.591)	5.0 (.197)	7.0 (.276)
20 (.787)	7.0 (.276)	12.0 (.472)
25 (.984)	10.0 (.394)	12.0 (.472)



L1	LB	L2
15 (.591)	5.0 (.197)	7.0 (.276)
20 (.787)	7.0 (.276)	10.0 (.394)
25 (.984)	10.0 (.394)	10.0 (.394)



L1	LB	L2
15 (.591)	5.0 (.197)	7.0 (.276)
20 (.787)	7.0 (.276)	10.0 (.394)
25 (.984)	10.0 (.394)	10.0 (.394)

DIMENSIONS:  $\frac{\text{MM}}{\text{(INCHES)}}$

# BOURNS®

Asia-Pacific: Tel: +886-2 2562-4117 • Fax: +886-2 2562-4116

Europe: Tel: +41-41 768 5555 • Fax: +41-41 768 5510

The Americas: Tel: +1-951 781-5500 • Fax: +1-951 781-5700

[www.bourns.com](http://www.bourns.com)

REV. 10/11

Specifications are subject to change without notice.  
Customers should verify actual device performance in their specific applications.

## Данный компонент на территории Российской Федерации

### Вы можете приобрести в компании MosChip.

Для оперативного оформления запроса Вам необходимо перейти по данной ссылке:

<http://moschip.ru/get-element>

Вы можете разместить у нас заказ для любого Вашего проекта, будь то серийное производство или разработка единичного прибора.

В нашем ассортименте представлены ведущие мировые производители активных и пассивных электронных компонентов.

Нашей специализацией является поставка электронной компонентной базы двойного назначения, продукции таких производителей как XILINX, Intel (ex.ALTERA), Vicor, Microchip, Texas Instruments, Analog Devices, Mini-Circuits, Amphenol, Glenair.

Сотрудничество с глобальными дистрибьюторами электронных компонентов, предоставляет возможность заказывать и получать с международных складов практически любой перечень компонентов в оптимальные для Вас сроки.

На всех этапах разработки и производства наши партнеры могут получить квалифицированную поддержку опытных инженеров.

Система менеджмента качества компании отвечает требованиям в соответствии с ГОСТ Р ИСО 9001, ГОСТ РВ 0015-002 и ЭС РД 009

### Офис по работе с юридическими лицами:

105318, г.Москва, ул.Щербаковская д.3, офис 1107, 1118, ДЦ «Щербаковский»

Телефон: +7 495 668-12-70 (многоканальный)

Факс: +7 495 668-12-70 (доб.304)

E-mail: [info@moschip.ru](mailto:info@moschip.ru)

Skype отдела продаж:

moschip.ru

moschip.ru\_4

moschip.ru\_6

moschip.ru\_9