



# BIPOLAR ANALOG INTEGRATED CIRCUIT

## $\mu$ PC2745TB, $\mu$ PC2746TB

### 3 V, SUPER MINIMOLD SILICON MMIC WIDEBAND AMPLIFIER FOR MOBILE COMMUNICATIONS

#### DESCRIPTION

The  $\mu$ PC2745TB and  $\mu$ PC2746TB are silicon monolithic integrated circuits designed as buffer amplifier for mobile communications. These low current amplifiers operate on 3.0 V (1.8 V MIN.).

These ICs are manufactured using our 20 GHz fr NESATIII silicon bipolar process. This process uses silicon nitride passivation film and gold electrodes. These materials can protect chip surface from external pollution and prevent corrosion/migration. Thus, these IC have excellent performance, uniformity and reliability.

#### FEATURES

- Supply voltage : Recommended  $V_{CC} = 2.7$  to  $3.3$  V  
Circuit operation  $V_{CC} = 1.8$  to  $3.3$  V
- Upper limit operating frequency :  $\mu$ PC2745TB;  $f_u = 2.7$  GHz TYP. @3 dB bandwidth  
 $\mu$ PC2746TB;  $f_u = 1.5$  GHz TYP. @3 dB bandwidth
- High isolation :  $\mu$ PC2745TB; ISL = 38 dB TYP. @f = 500 MHz  
 $\mu$ PC2746TB; ISL = 45 dB TYP. @f = 500 MHz
- Power gain :  $\mu$ PC2745TB;  $G_P = 12$  dB TYP. @f = 500 MHz  
 $\mu$ PC2746TB;  $G_P = 19$  dB TYP. @f = 500 MHz
- Saturated output power :  $\mu$ PC2745TB;  $P_{O(sat)} = -1$  dBm TYP. @f = 500 MHz  
 $\mu$ PC2746TB;  $P_{O(sat)} = 0$  dBm TYP. @f = 500 MHz
- High-density surface mounting : 6-pin super minimold package ( $2.0 \times 1.25 \times 0.9$  mm)

#### APPLICATIONS

- 1.5 GHz to 2.5 GHz communication system :  $\mu$ PC2745TB
- 800 MHz to 900 MHz communication system :  $\mu$ PC2746TB

#### ORDERING INFORMATION

| Part Number         | Package              | Marking | Supplying Form   |
|---------------------|----------------------|---------|--|
| $\mu$ PC2745TB-E3-A | 6-pin super minimold | C1Q     | • Embossed tape 8 mm wide<br>• 1, 2, 3 pins face the perforation side of the tape<br>• Qty 3 kpcs/reel |
| $\mu$ PC2746TB-E3-A |                      | C1R     |  |

**Remark** To order evaluation samples, contact your nearby sales office.  
Part number for sample order:  $\mu$ PC2745TB-A,  $\mu$ PC2746TB-A

**Caution: Observe precautions when handling because these devices are sensitive to electrostatic discharge.**

The information in this document is subject to change without notice. Before using this document, please confirm that this is the latest version.

**PIN CONNECTION**

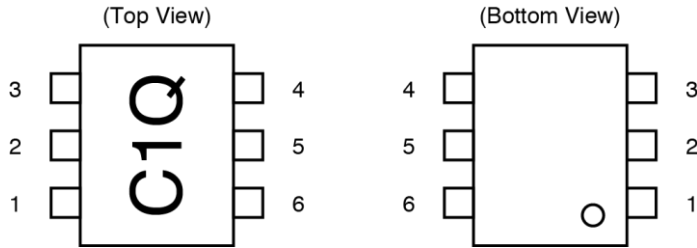

Marking is an example of  $\mu$ PC2745TB

| Pin No. | Pin Name        |
|---------|-----------------|
| 1       | INPUT           |
| 2       | GND             |
| 3       | GND             |
| 4       | OUTPUT          |
| 5       | GND             |
| 6       | V <sub>CC</sub> |

**PRODUCT LINE-UP (T<sub>A</sub> = +25°C, V<sub>CC</sub> = 3.0 V, Z<sub>S</sub> = Z<sub>L</sub> = 50 Ω)**

| Part No.       | f <sub>u</sub> (GHz) | P <sub>O(sat)</sub> (dBm) | G <sub>P</sub> (dB) | NF (dB) | I <sub>CC</sub> (mA) | Package              | Making |
|----------------|----------------------|---------------------------|---------------------|---------|----------------------|----------------------|--------|
| $\mu$ PC2745T  | 2.7                  | -1.0                      | 12                  | 6.0     | 7.5                  | 6-pin minimold       | C1Q    |
| $\mu$ PC2745TB |                      |                           |                     |         |                      | 6-pin super minimold |        |
| $\mu$ PC2746T  | 1.5                  | 0                         | 19                  | 4.0     | 7.5                  | 6-pin minimold       | C1R    |
| $\mu$ PC2746TB |                      |                           |                     |         |                      | 6-pin super minimold |        |
| $\mu$ PC2747T  | 1.8                  | -7.0                      | 12                  | 3.3     | 5.0                  | 6-pin minimold       | C1S    |
| $\mu$ PC2747TB |                      |                           |                     |         |                      | 6-pin super minimold |        |
| $\mu$ PC2748T  | 0.2 to 1.5           | -3.5                      | 19                  | 2.8     | 6.0                  | 6-pin minimold       | C1T    |
| $\mu$ PC2748TB |                      |                           |                     |         |                      | 6-pin super minimold |        |
| $\mu$ PC2749T  | 2.9                  | -6.0                      | 16                  | 4.0     | 6.0                  | 6-pin minimold       | C1U    |
| $\mu$ PC2749TB |                      |                           |                     |         |                      | 6-pin super minimold |        |

**Remark** Typical performance. Please refer to **ELECTRICAL CHARACTERISTICS** in detail.

**Caution** The package size distinguish between minimold and super minimold.

**SYSTEM APPLICATION EXAMPLE**

**DIGITAL CELLULAR SYSTEM BLOCK DIAGRAM**

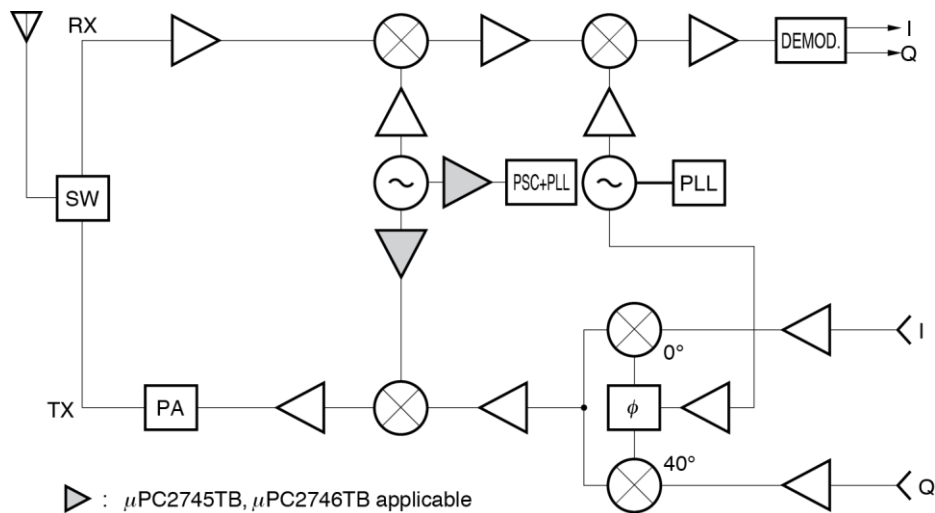

**PIN EXPLANATION**

| Pin No.     | Pin Name        | Applied Voltage (V) | Pin Voltage (V)<br><small>Note</small> | Function and Applications  | Internal Equivalent Circuit |
|-------------|-----------------|---------------------|--|--|-----------------------------|
| 1           | INPUT           | —                   | 0.87<br>-----<br>0.82                  | Signal input pin. A internal matching circuit, configured with resistors, enables 50 $\Omega$ connection over a wide band. this pin must be coupled to signal source with capacitor for DC cut.  |                             |
| 2<br>3<br>5 | GND             | 0                   | —                                      | Ground pin. This pin should be connected to system ground with minimum inductance. Ground pattern on the board should be formed as wide as possible. All the ground pins must be connected together with wide ground pattern to decrease impedance difference. |                             |
| 4           | OUTPUT          | —                   | 1.95<br>-----<br>2.54                  | Signal output pin. A internal matching circuit, configured with resistors, enables 50 $\Omega$ connection over a wide band. This pin must be coupled to next stage with capacitor for DC cut.  |                             |
| 6           | V <sub>CC</sub> | 2.7 to 3.3          | —                                      | Power supply pin. This pin should be externally equipped with bypass capacity to minimize ground impedance.  |                             |

**Note** Pin voltage is measured at V<sub>CC</sub> = 3.0 V. Above:  $\mu$ PC2745TB, Below:  $\mu$ PC2746TB

**ABSOLUTE MAXIMUM RATINGS**

| Parameter                     | Symbol           | Conditions                         | Ratings     | Unit |
|-------------------------------|------------------|------------------------------------|-------------|------|
| Supply Voltage                | V <sub>CC</sub>  | T <sub>A</sub> = +25°C             | 4.0         | V    |
| Circuit Current               | I <sub>CC</sub>  | T <sub>A</sub> = +25°C             | 16          | mA   |
| Power Dissipation             | P <sub>D</sub>   | T <sub>A</sub> = +85°C <b>Note</b> | 270         | mW   |
| Operating Ambient Temperature | T <sub>A</sub>   |                                    | -40 to +85  | °C   |
| Storage Temperature           | T <sub>stg</sub> |                                    | -55 to +150 | °C   |
| Input Power                   | P <sub>in</sub>  | T <sub>A</sub> = +25°C             | 0           | dBm  |

**Note** Mounted on double-sided copper-clad 50 × 50 × 1.6 mm epoxy glass PWB

**RECOMMENDED OPERATING RANGE**

| Parameter      | Symbol          | MIN. | TYP. | MAX. | Unit |
|----------------|-----------------|------|------|------|------|
| Supply Voltage | V <sub>CC</sub> | 2.7  | 3.0  | 3.3  | V    |

**ELECTRICAL CHARACTERISTICS**

(T<sub>A</sub> = +25°C, V<sub>CC</sub> = 3.0 V, Z<sub>S</sub> = Z<sub>L</sub> = 50 Ω, unless otherwise specified)

| Parameter                       | Symbol              | Test Conditions                          | $\mu$ PC2745TB |      |      | $\mu$ PC2746TB |      |      | Unit |
|---------------------------------|---------------------|--|----------------|------|------|----------------|------|------|------|
|                                 |                     |  | MIN.           | TYP. | MAX. | MIN.           | TYP. | MAX. |      |
| Circuit Current                 | I <sub>CC</sub>     | No signal                                | 5.0            | 7.5  | 10.0 | 5.0            | 7.5  | 10.0 | mA   |
| Power Gain                      | G <sub>P</sub>      | f = 500 MHz                              | 9              | 12   | 14   | 16             | 19   | 21   | dB   |
| Noise Figure                    | NF                  | f = 500 MHz                              | —              | 6.0  | 7.5  | —              | 4.0  | 5.5  | dB   |
| Upper Limit Operating Frequency | f <sub>u</sub>      | 3 dB down below from gain at f = 0.1 GHz | 2.3            | 2.7  | —    | 1.1            | 1.5  | —    | GHz  |
| Isolation                       | ISL                 | f = 500 MHz                              | 33             | 38   | —    | 40             | 45   | —    | dB   |
| Input Return Loss               | RL <sub>in</sub>    | f = 500 MHz                              | 8              | 11   | —    | 10             | 13   | —    | dB   |
| Output Return Loss              | RL <sub>out</sub>   | f = 500 MHz                              | 2.5            | 5.5  | —    | 5.5            | 8.5  | —    | dB   |
| Saturated Output Power          | P <sub>O(sat)</sub> | f = 500 MHz, P <sub>in</sub> = -6 dBm    | -4.0           | -1.0 | —    | -3.0           | 0    | —    | dBm  |

**STANDARD CHARACTERISTICS FOR REFERENCE (T<sub>A</sub> = +25°C, V<sub>CC</sub> = 3.0 V, Z<sub>S</sub> = Z<sub>L</sub> = 50 Ω)**

| Parameter                            | Symbol              | Test Conditions   | Reference Value |                | Unit |
|--------------------------------------|---------------------|---|-----------------|----------------|------|
|                                      |                     |   | $\mu$ PC2745TB  | $\mu$ PC2746TB |      |
| Circuit Current                      | I <sub>CC</sub>     | V <sub>CC</sub> = 1.8 V, No signal  | 4.5             | 4.5            | mA   |
| Power Gain                           | G <sub>P</sub>      | V <sub>CC</sub> = 3.0 V, f = 1.0 GHz  | 12.0            | 18.5           | dB   |
|                                      |                     | V <sub>CC</sub> = 3.0 V, f = 2.0 GHz  | 11.0            | —              |      |
|                                      |                     | V <sub>CC</sub> = 1.8 V, f = 0.5 GHz  | 7.0             | 14.0           |      |
| Noise Figure                         | NF                  | V <sub>CC</sub> = 3.0 V, f = 1.0 GHz  | 5.5             | 4.2            | dB   |
|                                      |                     | V <sub>CC</sub> = 3.0 V, f = 2.0 GHz  | 5.7             | —              |      |
|                                      |                     | V <sub>CC</sub> = 1.8 V, f = 0.5 GHz  | 8.0             | 5.0            |      |
| Upper Limit Operating Frequency      | f <sub>u</sub>      | V <sub>CC</sub> = 1.8 V, 3 dB down below from gain at f = 0.1 GHz   | 1.8             | 1.1            | GHz  |
| Isolation                            | ISL                 | V <sub>CC</sub> = 3.0 V, f = 1.0 GHz  | 33              | 38             | dB   |
|                                      |                     | V <sub>CC</sub> = 3.0 V, f = 2.0 GHz  | 30              | —              |      |
|                                      |                     | V <sub>CC</sub> = 1.8 V, f = 0.5 GHz  | 35              | 37             |      |
| Input Return Loss                    | RL <sub>in</sub>    | V <sub>CC</sub> = 3.0 V, f = 1.0 GHz  | 13.0            | 10.0           | dB   |
|                                      |                     | V <sub>CC</sub> = 3.0 V, f = 2.0 GHz  | 14.0            | —              |      |
|                                      |                     | V <sub>CC</sub> = 1.8 V, f = 0.5 GHz  | 6.5             | 10.0           |      |
| Output Return Loss                   | RL <sub>out</sub>   | V <sub>CC</sub> = 3.0 V, f = 1.0 GHz  | 6.5             | 8.5            | dB   |
|                                      |                     | V <sub>CC</sub> = 3.0 V, f = 2.0 GHz  | 8.5             | —              |      |
|                                      |                     | V <sub>CC</sub> = 1.8 V, f = 0.5 GHz  | 6.0             | 9.5            |      |
| Saturated Output Power               | P <sub>O(sat)</sub> | V <sub>CC</sub> = 3.0 V, f = 1.0 GHz, P <sub>in</sub> = -6 dBm  | -2.5            | -1.0           | dBm  |
|                                      |                     | V <sub>CC</sub> = 3.0 V, f = 2.0 GHz, P <sub>in</sub> = -6 dBm  | -3.5            | —              |      |
|                                      |                     | V <sub>CC</sub> = 1.8 V, f = 0.5 GHz, P <sub>in</sub> = -10 dBm   | -11.0           | -8.0           |      |
| 3rd Order Intermodulation Distortion | IM <sub>3</sub>     | V <sub>CC</sub> = 3.0 V, P <sub>out</sub> = -10 dBm, f <sub>1</sub> = 500 MHz, f <sub>2</sub> = 502 MHz     | -30.0           | -26.0          | dBc  |
|                                      |                     | V <sub>CC</sub> = 1.8 V, P <sub>out</sub> = -20 dBm, f <sub>1</sub> = 500 MHz, f <sub>2</sub> = 502 MHz     | -31.0           | -37.0          |      |
|                                      |                     | V <sub>CC</sub> = 3.0 V, P <sub>out</sub> = -10 dBm, f <sub>1</sub> = 1 000 MHz, f <sub>2</sub> = 1 002 MHz | -26.0           | —              |      |



**TEST CIRCUIT**

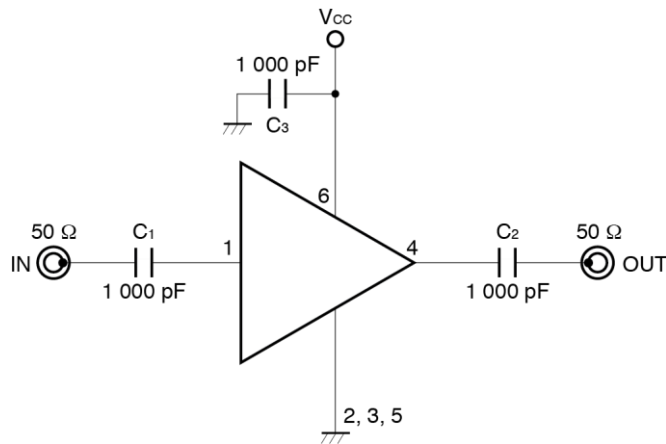

**EXAMPLE OF APPLICATION CIRCUIT**

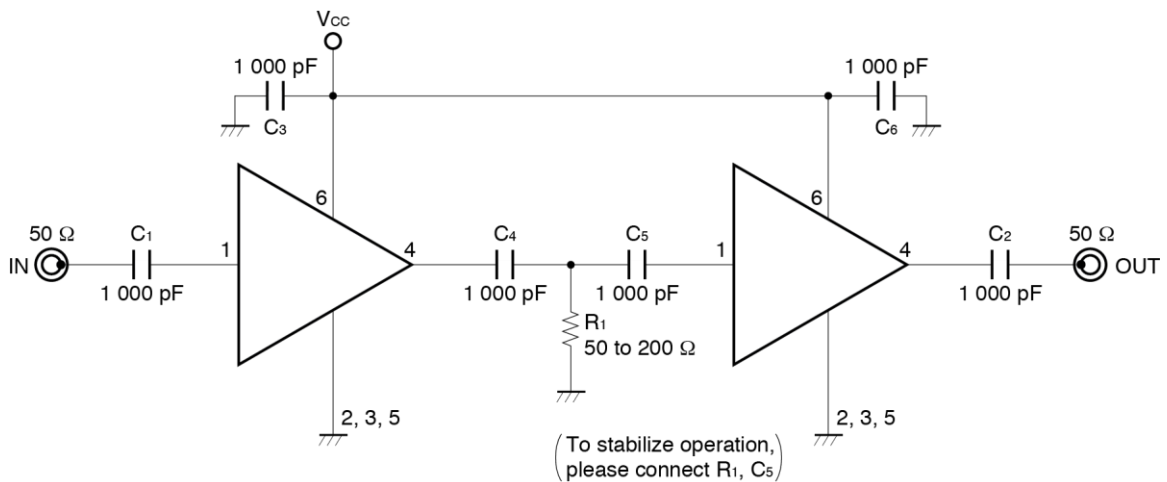

The application circuits and their parameters are for references only and are not intended for use in actual design-ins.

**CAPACITORS FOR THE V<sub>CC</sub>, INPUT, AND OUTPUT PINS**

Capacitors of 1 000 pF are recommendable as the bypass capacitor for the V<sub>CC</sub> pin and the coupling capacitors for the input and output pins.

The bypass capacitor connected to the V<sub>CC</sub> pin is used to minimize ground impedance of V<sub>CC</sub> pin. So, stable bias can be supplied against V<sub>CC</sub> fluctuation.

The coupling capacitors, connected to the input and output pins, are used to cut the DC and minimize RF serial impedance. Their capacitance are therefore selected as lower impedance against a 50  $\Omega$  load. The capacitors thus perform as high pass filters, suppressing low frequencies to DC.

To obtain a flat gain from 100 MHz upwards, 1 000 pF capacitors are used in the test circuit. In the case of under 10 MHz operation, increase the value of coupling capacitor such as 10 000 pF. Because the coupling capacitors are determined by equation,  $f_c = 1/(2\pi RC)$ .

ILLUSTRATION OF THE TEST CIRCUIT ASSEMBLED ON EVALUATION BOARD

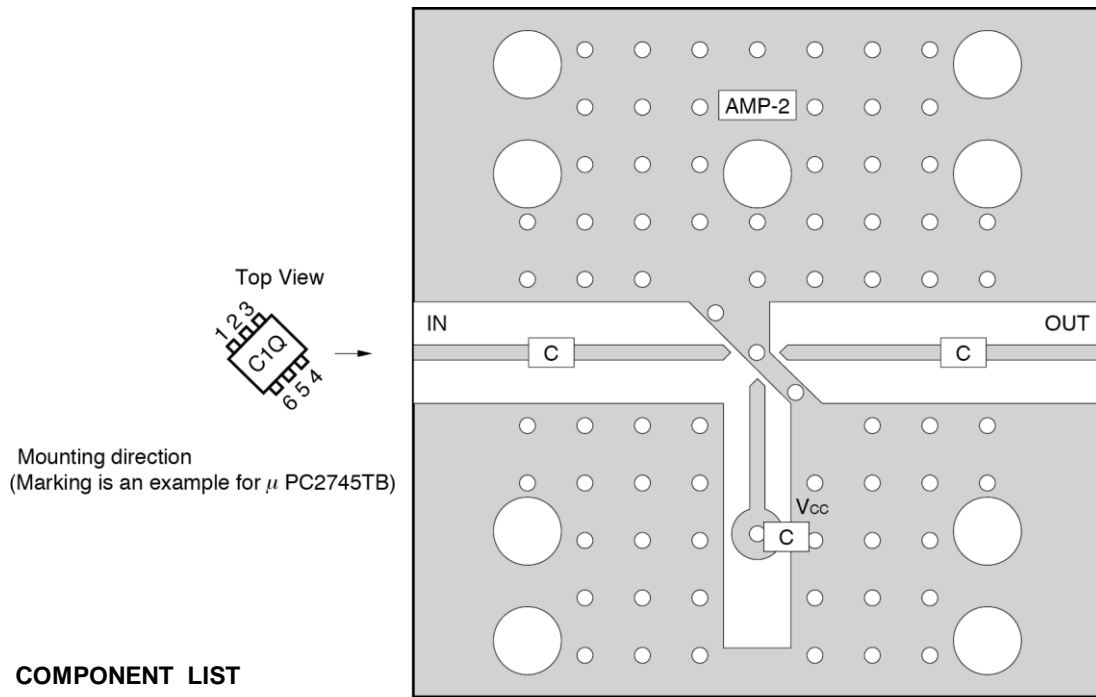

COMPONENT LIST

|   | Value    |
|---|----------|
| C | 1 000 pF |

Notes

1. 30 × 30 × 0.4 mm double sided copper clad polyimide board.
2. Back side: GND pattern
3. Solder plated on pattern
4.  $\oplus$   $\oplus$   $\oplus$ : Through holes

For more information on the use of this IC, refer to the following application note: **USAGE AND APPLICATIONS OF 6-PIN MINI-MOLD, 6-PIN SUPER MINI-MOLD SILICON HIGH-FREQUENCY WIDEBAND AMPLIFIER MMIC (P11976E).**

**TYPICAL CHARACTERISTICS ( $T_A = +25^\circ\text{C}$ , unless otherwise specified)**

—  $\mu$ PC2745TB —

CIRCUIT CURRENT vs. SUPPLY VOLTAGE

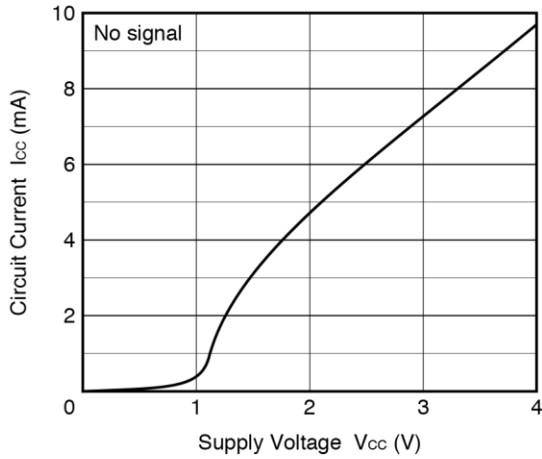

CIRCUIT CURRENT vs. OPERATING AMBIENT TEMPERATURE

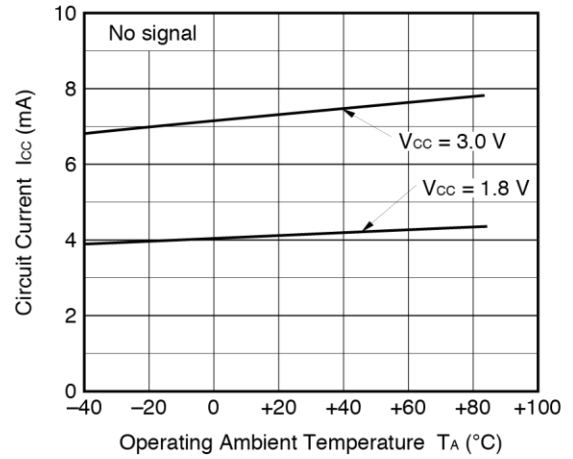

NOISE FIGURE, POWER GAIN vs. FREQUENCY

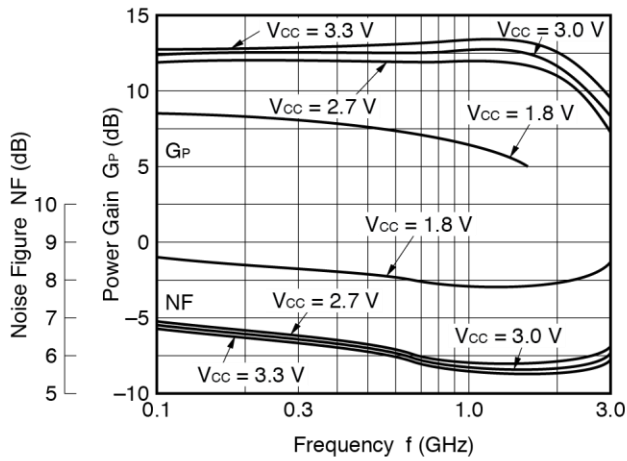

POWER GAIN vs. FREQUENCY

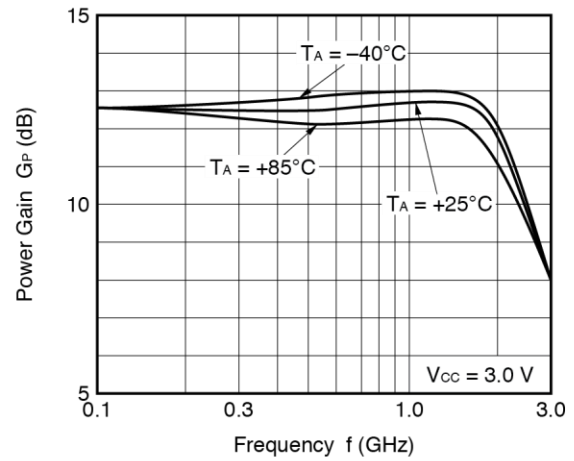

ISOLATION vs. FREQUENCY

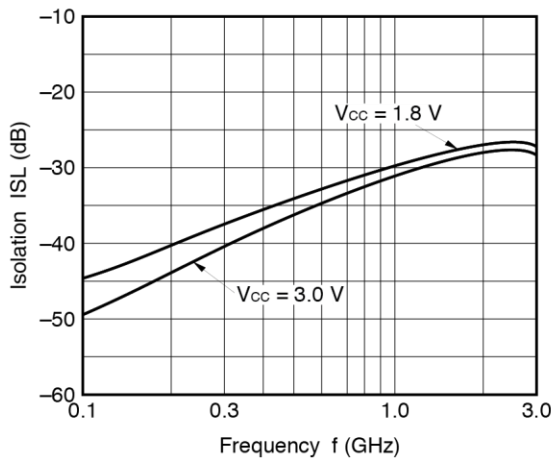

INPUT RETURN LOSS, OUTPUT RETURN LOSS vs. FREQUENCY

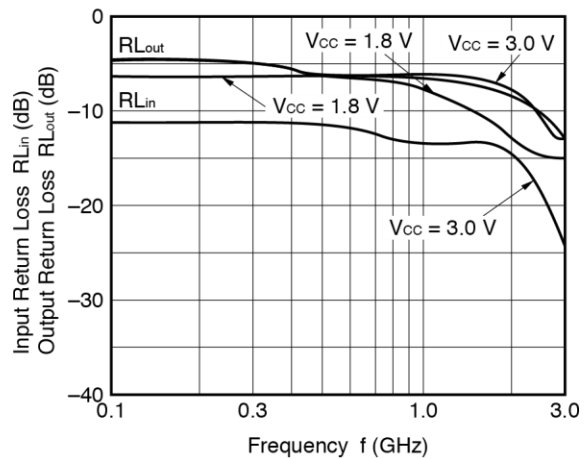

**Remark** The graphs indicate nominal characteristics.



—  $\mu$ PC2745TB —

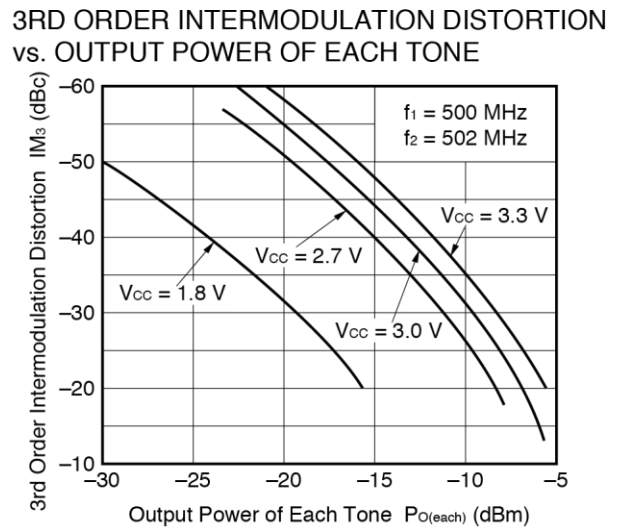
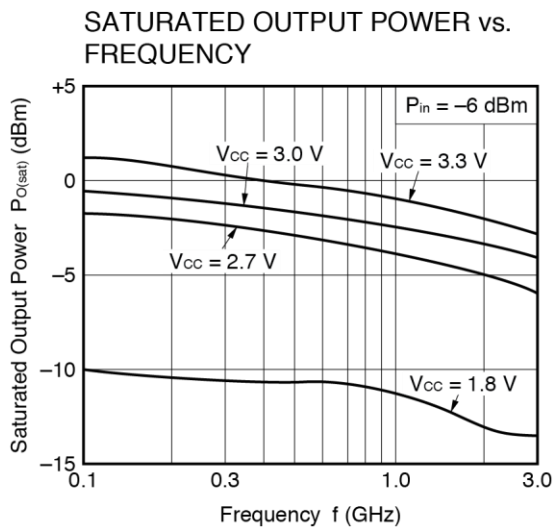
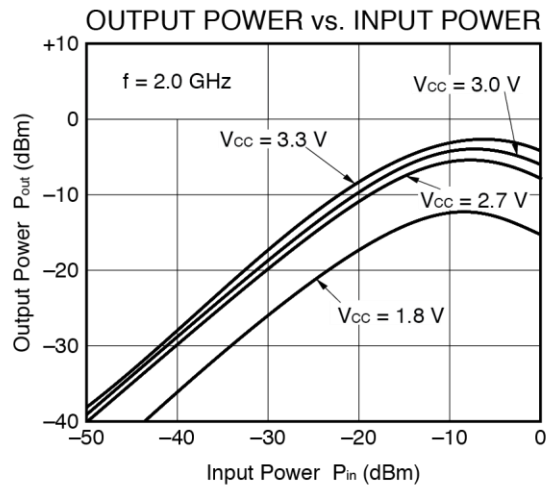
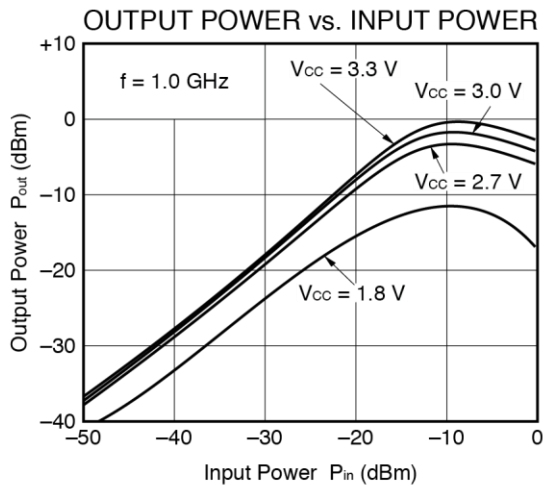
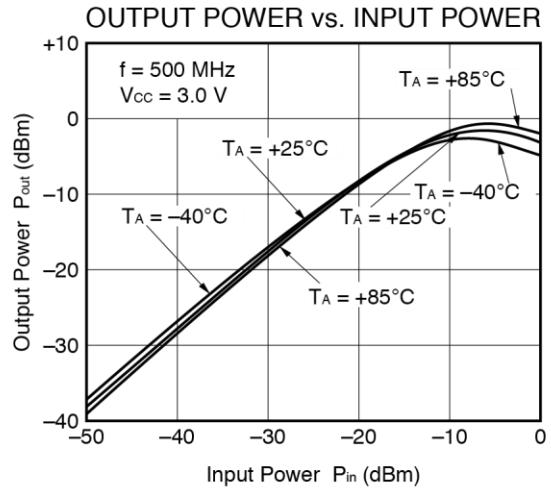
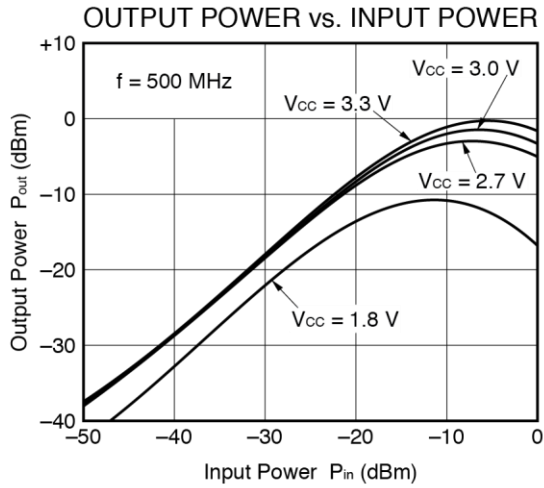

**Remark** The graphs indicate nominal characteristics.

**SMITH CHART ( $T_A = +25^\circ\text{C}$ ,  $V_{CC} = 3.0\text{ V}$ )**

—  $\mu$ PC2745TB —

S<sub>11</sub>-FREQUENCY

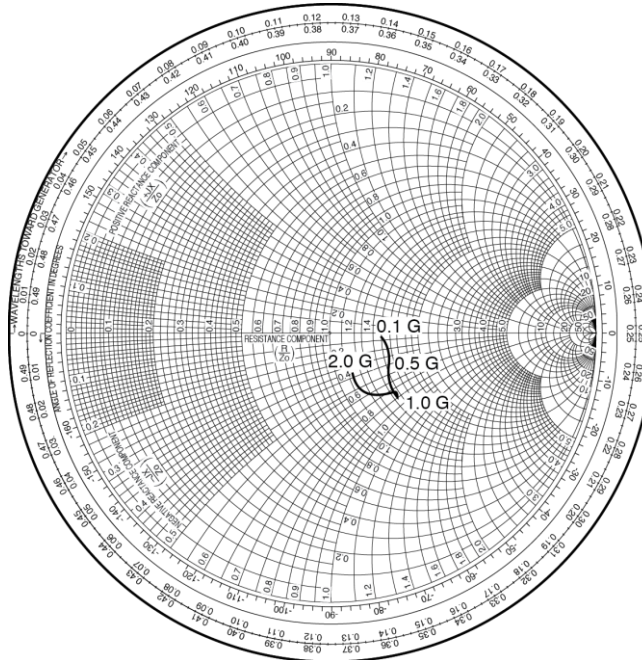

S<sub>22</sub>-FREQUENCY

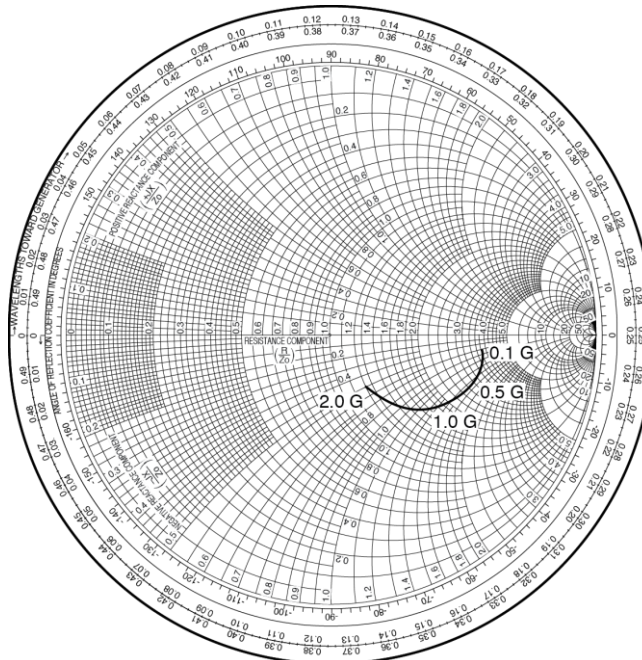

**S-PARAMETERS**

- S-parameters and noise parameters are provided on our Web site in a format (S2P) that enables the direct import of the parameters to microwave circuit simulators without the need for keyboard inputs.
- [Click here to download S-parameters.](#)
- [RF and Microwave] ® [Device Parameters]
- URL <http://www.necel.com/microwave/en/>

**TYPICAL CHARACTERISTICS ( $T_A = +25^\circ\text{C}$ , unless otherwise specified)**

—  $\mu$ PC2746TB —

CIRCUIT CURRENT vs. SUPPLY VOLTAGE

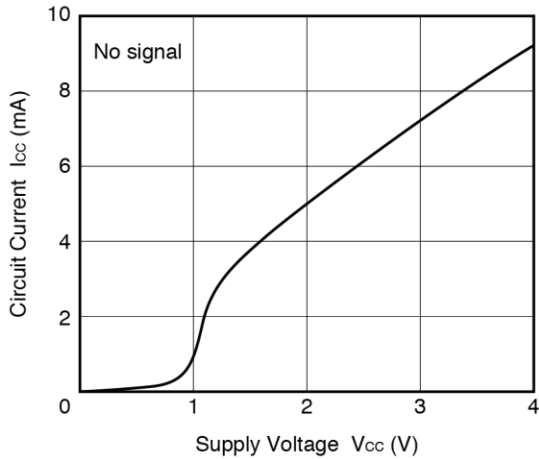

CIRCUIT CURRENT vs. OPERATING AMBIENT TEMPERATURE

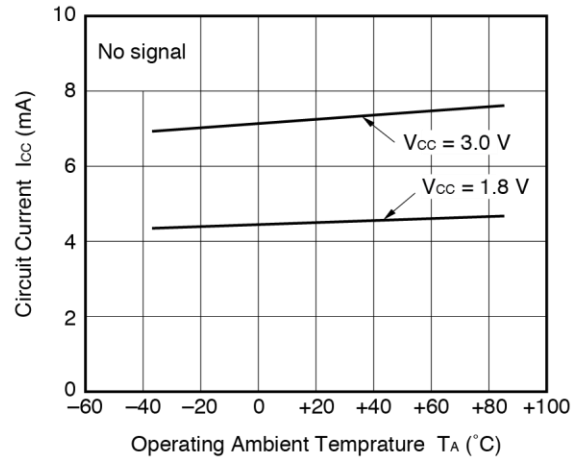

NOISE FIGURE, POWER GAIN vs. FREQUENCY

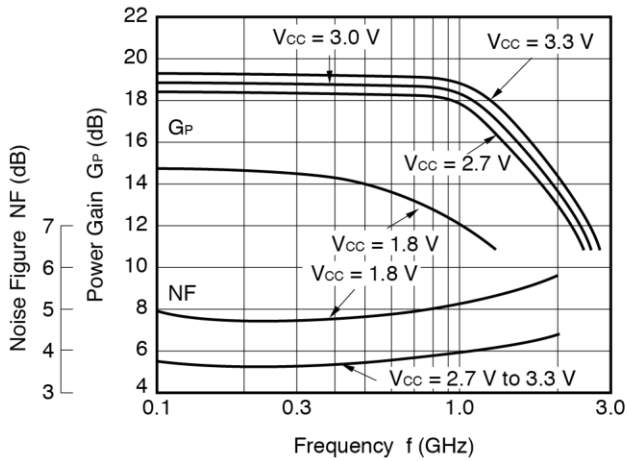

POWER GAIN vs. FREQUENCY

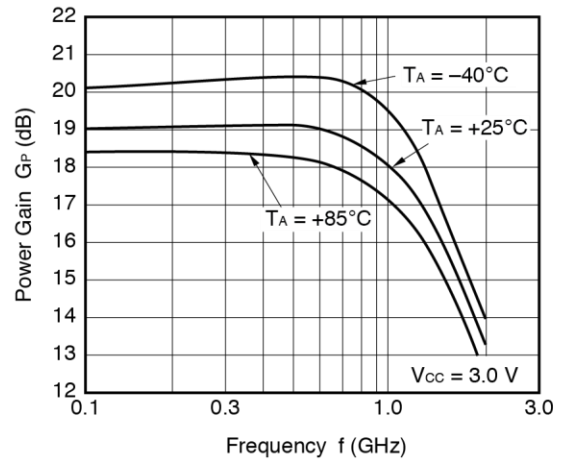

ISOLATION vs. FREQUENCY

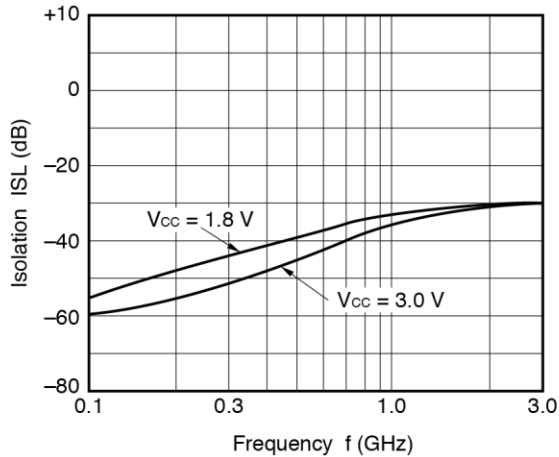

INPUT RETURN LOSS, OUTPUT RETURN LOSS vs. FREQUENCY

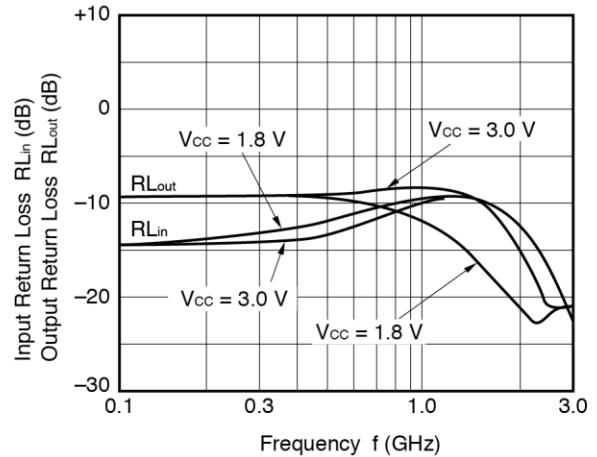

**Remark** The graphs indicate nominal characteristics.

—  $\mu$ PC2746TB —

OUTPUT POWER vs. INPUT POWER

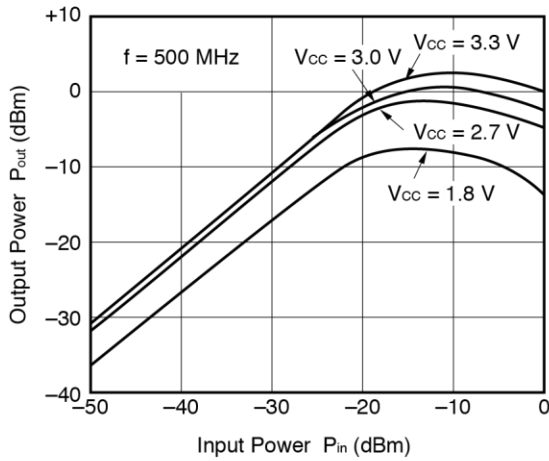

OUTPUT POWER vs. INPUT POWER

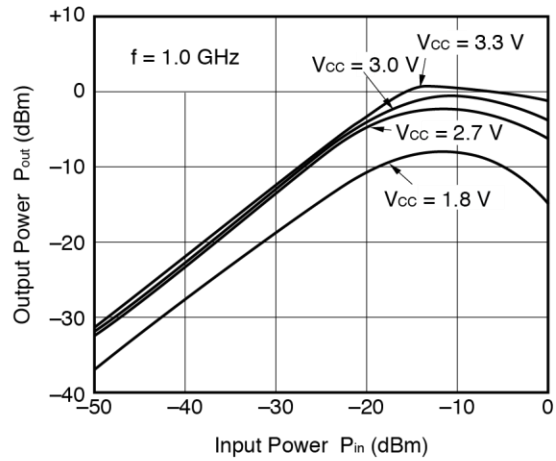

OUTPUT POWER vs. INPUT POWER

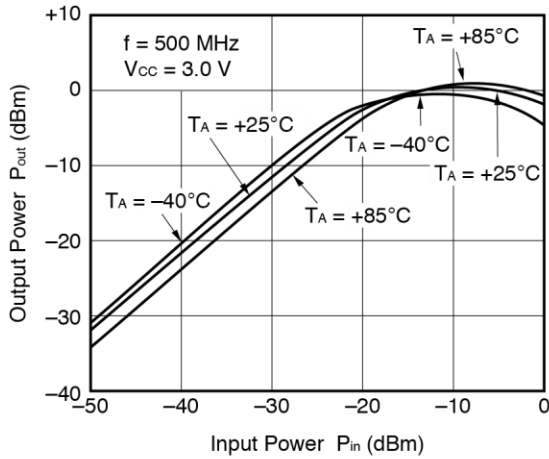

OUTPUT POWER vs. INPUT POWER

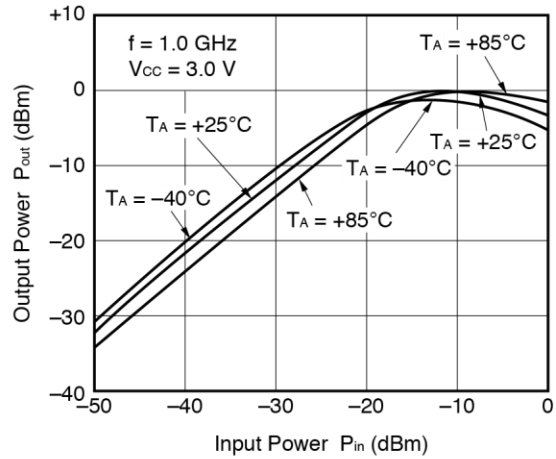

SATURATED OUTPUT POWER vs. FREQUENCY

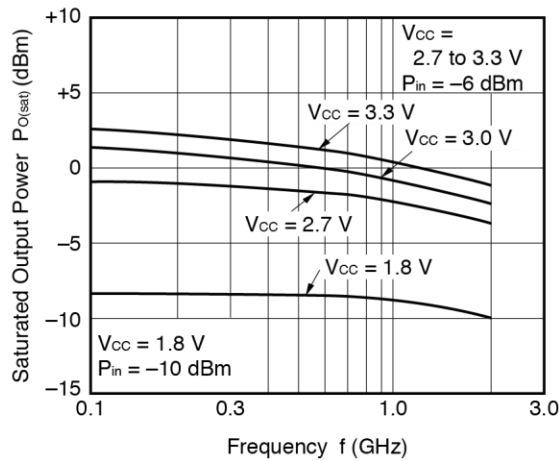

3RD ORDER INTERMODULATION DISTORTION vs. OUTPUT POWER OF EACH TONE

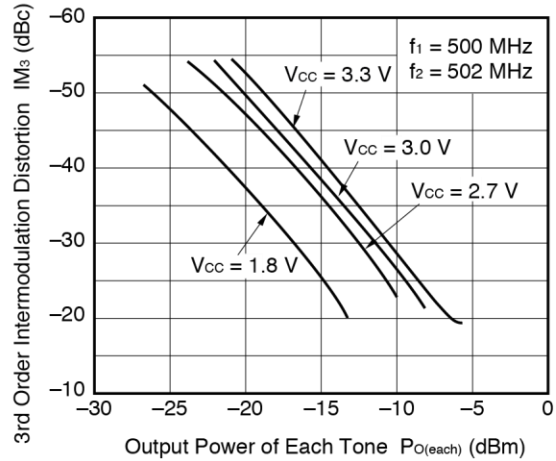

**Remark** The graphs indicate nominal characteristics.

SMITH CHART ( $T_A = +25^\circ\text{C}$ ,  $V_{CC} = 3.0\text{ V}$ )

—  $\mu$ PC2746TB —

S<sub>11</sub>-FREQUENCY

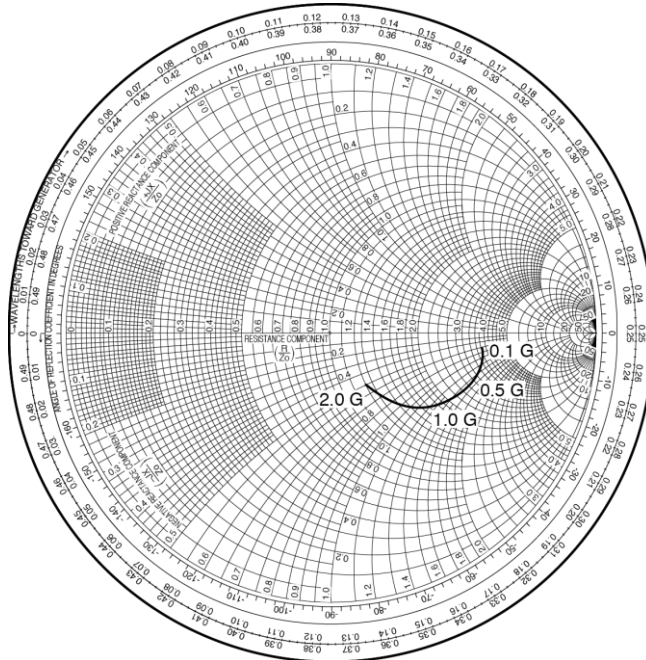

S<sub>22</sub>-FREQUENCY

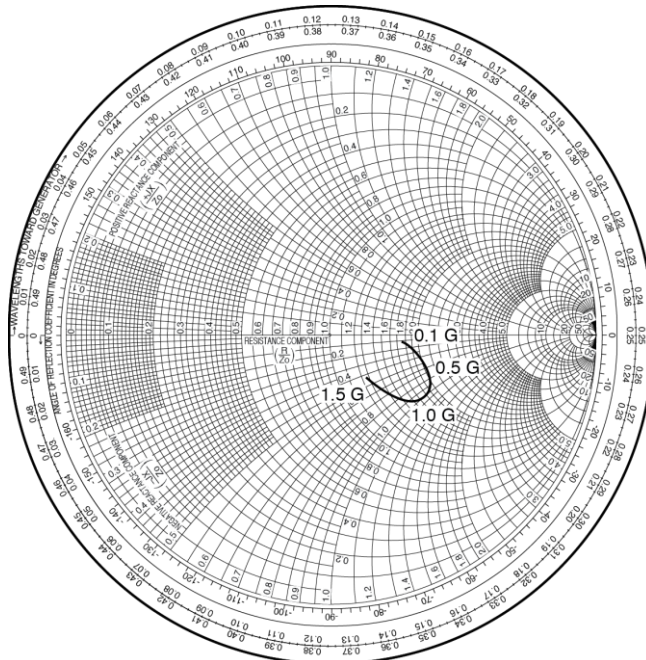

**S-PARAMETERS**

- S-parameters and noise parameters are provided on our Web site in a format (S2P) that enables the direct import of the parameters to microwave circuit simulators without the need for keyboard inputs.
- [Click here to download S-parameters.](#)
- [RF and Microwave] ® [Device Parameters]
- URL <http://www.necel.com/microwave/en/>

PACKAGE DIMENSIONS

6-PIN SUPER MINIMOLD (UNIT: mm)

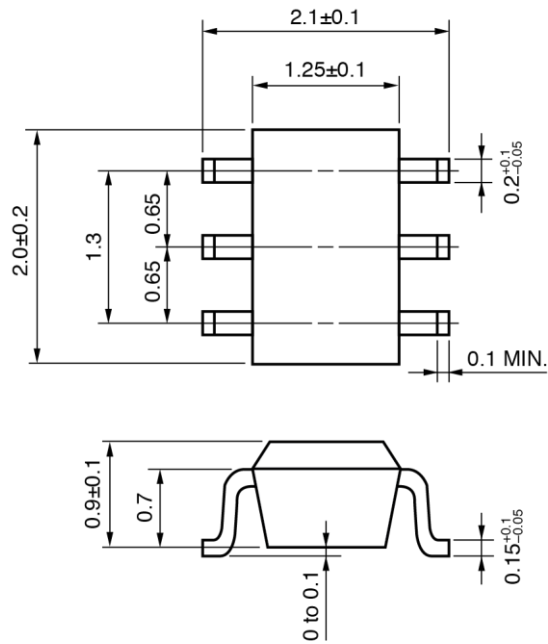



**NOTES ON CORRECT USE**

- (1) Observe precautions for handling because of electro-static sensitive devices.
- (2) Form a ground pattern as widely as possible to minimize ground impedance (to prevent undesired oscillation).  
All the ground pins must be connected together with wide ground pattern to decrease impedance difference.
- (3) The bypass capacitor should be attached to the V<sub>cc</sub> pin.
- (4) The DC cut capacitor must be attached to input pin and output pin.

**RECOMMENDED SOLDERING CONDITIONS**

This product should be soldered and mounted under the following recommended conditions. For soldering methods and conditions other than those recommended below, contact your nearby sales office.

| Soldering Method | Soldering Conditions  | Condition Symbol |
|------------------|---|------------------|
| Infrared Reflow  | Peak temperature (package surface temperature) : 260°C or below<br>Time at peak temperature : 10 seconds or less<br>Time at temperature of 220°C or higher : 60 seconds or less<br>Preheating time at 120 to 180°C : 120±30 seconds<br>Maximum number of reflow processes : 3 times<br>Maximum chlorine content of rosin flux (% mass) : 0.2%(Wt.) or below | IR260            |
| VPS              | Peak temperature (package surface temperature) : 215°C or below<br>Time at temperature of 200°C or higher : 25 to 40 seconds<br>Preheating time at 120 to 150°C : 30 to 60 seconds<br>Maximum number of reflow processes : 3 times<br>Maximum chlorine content of rosin flux (% mass) : 0.2%(Wt.) or below  | VP215            |
| Wave Soldering   | Peak temperature (molten solder temperature) : 260°C or below<br>Time at peak temperature : 10 seconds or less<br>Preheating temperature (package surface temperature) : 120°C or below<br>Maximum number of flow processes : 1 time<br>Maximum chlorine content of rosin flux (% mass) : 0.2%(Wt.) or below  | WS260            |
| Partial Heating  | Peak temperature (pin temperature) : 350°C or below<br>Soldering time (per side of device) : 3 seconds or less<br>Maximum chlorine content of rosin flux (% mass) : 0.2%(Wt.) or below  | HS350            |

**Caution Do not use different soldering methods together (except for partial heating).**

## Данный компонент на территории Российской Федерации

### Вы можете приобрести в компании MosChip.

Для оперативного оформления запроса Вам необходимо перейти по данной ссылке:

<http://moschip.ru/get-element>

Вы можете разместить у нас заказ для любого Вашего проекта, будь то серийное производство или разработка единичного прибора.

В нашем ассортименте представлены ведущие мировые производители активных и пассивных электронных компонентов.

Нашей специализацией является поставка электронной компонентной базы двойного назначения, продукции таких производителей как XILINX, Intel (ex.ALTERA), Vicor, Microchip, Texas Instruments, Analog Devices, Mini-Circuits, Amphenol, Glenair.

Сотрудничество с глобальными дистрибьюторами электронных компонентов, предоставляет возможность заказывать и получать с международных складов практически любой перечень компонентов в оптимальные для Вас сроки.

На всех этапах разработки и производства наши партнеры могут получить квалифицированную поддержку опытных инженеров.

Система менеджмента качества компании отвечает требованиям в соответствии с ГОСТ Р ИСО 9001, ГОСТ РВ 0015-002 и ЭС РД 009

### Офис по работе с юридическими лицами:

105318, г.Москва, ул.Щербаковская д.3, офис 1107, 1118, ДЦ «Щербаковский»

Телефон: +7 495 668-12-70 (многоканальный)

Факс: +7 495 668-12-70 (доб.304)

E-mail: [info@moschip.ru](mailto:info@moschip.ru)

Skype отдела продаж:

moschip.ru

moschip.ru\_4

moschip.ru\_6

moschip.ru\_9