



BIPOLAR ANALOG INTEGRATED CIRCUIT

μ PC2745TB, μ PC2746TB

3 V, SUPER MINIMOLD SILICON MMIC WIDEBAND AMPLIFIER FOR MOBILE COMMUNICATIONS

DESCRIPTION

The μ PC2745TB and μ PC2746TB are silicon monolithic integrated circuits designed as buffer amplifier for mobile communications. These low current amplifiers operate on 3.0 V (1.8 V MIN.).

These ICs are manufactured using our 20 GHz fr NESATIII silicon bipolar process. This process uses silicon nitride passivation film and gold electrodes. These materials can protect chip surface from external pollution and prevent corrosion/migration. Thus, these IC have excellent performance, uniformity and reliability.

FEATURES

- Supply voltage : Recommended $V_{CC} = 2.7$ to 3.3 V
Circuit operation $V_{CC} = 1.8$ to 3.3 V
- Upper limit operating frequency : μ PC2745TB; $f_u = 2.7$ GHz TYP. @3 dB bandwidth
 μ PC2746TB; $f_u = 1.5$ GHz TYP. @3 dB bandwidth
- High isolation : μ PC2745TB; ISL = 38 dB TYP. @f = 500 MHz
 μ PC2746TB; ISL = 45 dB TYP. @f = 500 MHz
- Power gain : μ PC2745TB; $G_P = 12$ dB TYP. @f = 500 MHz
 μ PC2746TB; $G_P = 19$ dB TYP. @f = 500 MHz
- Saturated output power : μ PC2745TB; $P_{O(sat)} = -1$ dBm TYP. @f = 500 MHz
 μ PC2746TB; $P_{O(sat)} = 0$ dBm TYP. @f = 500 MHz
- High-density surface mounting : 6-pin super minimold package ($2.0 \times 1.25 \times 0.9$ mm)

APPLICATIONS

- 1.5 GHz to 2.5 GHz communication system : μ PC2745TB
- 800 MHz to 900 MHz communication system : μ PC2746TB

ORDERING INFORMATION

Part Number	Package	Marking	Supplying Form
μ PC2745TB-E3-A	6-pin super minimold	C1Q	• Embossed tape 8 mm wide • 1, 2, 3 pins face the perforation side of the tape • Qty 3 kpcs/reel
μ PC2746TB-E3-A		C1R	

Remark To order evaluation samples, contact your nearby sales office.
Part number for sample order: μ PC2745TB-A, μ PC2746TB-A

Caution: Observe precautions when handling because these devices are sensitive to electrostatic discharge.

The information in this document is subject to change without notice. Before using this document, please confirm that this is the latest version.

PIN CONNECTION

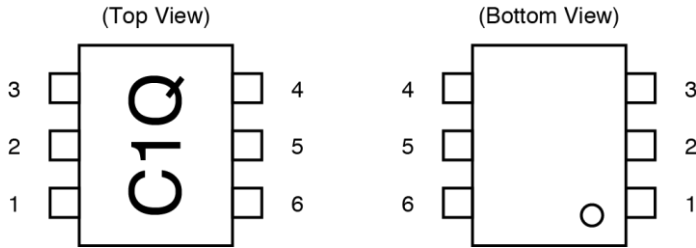

Marking is an example of μ PC2745TB

Pin No.	Pin Name
1	INPUT
2	GND
3	GND
4	OUTPUT
5	GND
6	V _{CC}

PRODUCT LINE-UP (T_A = +25°C, V_{CC} = 3.0 V, Z_S = Z_L = 50 Ω)

Part No.	f _u (GHz)	P _{O(sat)} (dBm)	G _P (dB)	NF (dB)	I _{CC} (mA)	Package	Making
μ PC2745T	2.7	-1.0	12	6.0	7.5	6-pin minimold	C1Q
μ PC2745TB						6-pin super minimold	
μ PC2746T	1.5	0	19	4.0	7.5	6-pin minimold	C1R
μ PC2746TB						6-pin super minimold	
μ PC2747T	1.8	-7.0	12	3.3	5.0	6-pin minimold	C1S
μ PC2747TB						6-pin super minimold	
μ PC2748T	0.2 to 1.5	-3.5	19	2.8	6.0	6-pin minimold	C1T
μ PC2748TB						6-pin super minimold	
μ PC2749T	2.9	-6.0	16	4.0	6.0	6-pin minimold	C1U
μ PC2749TB						6-pin super minimold	

Remark Typical performance. Please refer to **ELECTRICAL CHARACTERISTICS** in detail.

Caution The package size distinguish between minimold and super minimold.

SYSTEM APPLICATION EXAMPLE

DIGITAL CELLULAR SYSTEM BLOCK DIAGRAM

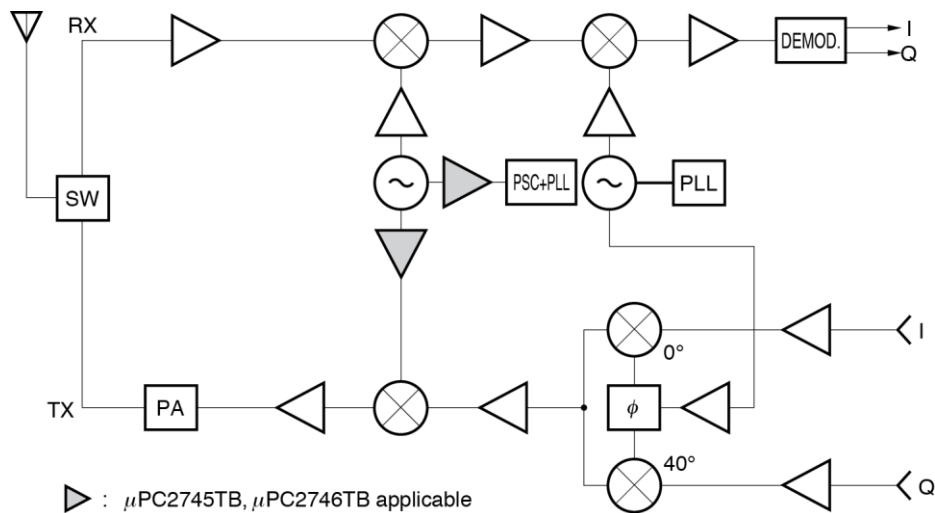

PIN EXPLANATION

Pin No.	Pin Name	Applied Voltage (V)	Pin Voltage (V) <small>Note</small>	Function and Applications	Internal Equivalent Circuit
1	INPUT	—	0.87 ----- 0.82	Signal input pin. A internal matching circuit, configured with resistors, enables 50 Ω connection over a wide band. this pin must be coupled to signal source with capacitor for DC cut.	
2 3 5	GND	0	—	Ground pin. This pin should be connected to system ground with minimum inductance. Ground pattern on the board should be formed as wide as possible. All the ground pins must be connected together with wide ground pattern to decrease impedance difference.	
4	OUTPUT	—	1.95 ----- 2.54	Signal output pin. A internal matching circuit, configured with resistors, enables 50 Ω connection over a wide band. This pin must be coupled to next stage with capacitor for DC cut.	
6	V _{CC}	2.7 to 3.3	—	Power supply pin. This pin should be externally equipped with bypass capacity to minimize ground impedance.	

Note Pin voltage is measured at V_{CC} = 3.0 V. Above: μ PC2745TB, Below: μ PC2746TB

ABSOLUTE MAXIMUM RATINGS

Parameter	Symbol	Conditions	Ratings	Unit
Supply Voltage	V _{CC}	T _A = +25°C	4.0	V
Circuit Current	I _{CC}	T _A = +25°C	16	mA
Power Dissipation	P _D	T _A = +85°C Note	270	mW
Operating Ambient Temperature	T _A		-40 to +85	°C
Storage Temperature	T _{stg}		-55 to +150	°C
Input Power	P _{in}	T _A = +25°C	0	dBm

Note Mounted on double-sided copper-clad 50 × 50 × 1.6 mm epoxy glass PWB

RECOMMENDED OPERATING RANGE

Parameter	Symbol	MIN.	TYP.	MAX.	Unit
Supply Voltage	V _{CC}	2.7	3.0	3.3	V

ELECTRICAL CHARACTERISTICS

(T_A = +25°C, V_{CC} = 3.0 V, Z_S = Z_L = 50 Ω, unless otherwise specified)

Parameter	Symbol	Test Conditions	μ PC2745TB			μ PC2746TB			Unit
			MIN.	TYP.	MAX.	MIN.	TYP.	MAX.	
Circuit Current	I _{CC}	No signal	5.0	7.5	10.0	5.0	7.5	10.0	mA
Power Gain	G _P	f = 500 MHz	9	12	14	16	19	21	dB
Noise Figure	NF	f = 500 MHz	—	6.0	7.5	—	4.0	5.5	dB
Upper Limit Operating Frequency	f _u	3 dB down below from gain at f = 0.1 GHz	2.3	2.7	—	1.1	1.5	—	GHz
Isolation	ISL	f = 500 MHz	33	38	—	40	45	—	dB
Input Return Loss	RL _{in}	f = 500 MHz	8	11	—	10	13	—	dB
Output Return Loss	RL _{out}	f = 500 MHz	2.5	5.5	—	5.5	8.5	—	dB
Saturated Output Power	P _{O(sat)}	f = 500 MHz, P _{in} = -6 dBm	-4.0	-1.0	—	-3.0	0	—	dBm

STANDARD CHARACTERISTICS FOR REFERENCE ($T_A = +25^\circ\text{C}$, $V_{CC} = 3.0\text{ V}$, $Z_S = Z_L = 50\ \Omega$)

Parameter	Symbol	Test Conditions	Reference Value		Unit
			μ PC2745TB	μ PC2746TB	
Circuit Current	I_{CC}	$V_{CC} = 1.8\text{ V}$, No signal	4.5	4.5	mA
Power Gain	G_P	$V_{CC} = 3.0\text{ V}$, $f = 1.0\text{ GHz}$	12.0	18.5	dB
		$V_{CC} = 3.0\text{ V}$, $f = 2.0\text{ GHz}$	11.0	—	
		$V_{CC} = 1.8\text{ V}$, $f = 0.5\text{ GHz}$	7.0	14.0	
Noise Figure	NF	$V_{CC} = 3.0\text{ V}$, $f = 1.0\text{ GHz}$	5.5	4.2	dB
		$V_{CC} = 3.0\text{ V}$, $f = 2.0\text{ GHz}$	5.7	—	
		$V_{CC} = 1.8\text{ V}$, $f = 0.5\text{ GHz}$	8.0	5.0	
Upper Limit Operating Frequency	f_u	$V_{CC} = 1.8\text{ V}$, 3 dB down below from gain at $f = 0.1\text{ GHz}$	1.8	1.1	GHz
Isolation	ISL	$V_{CC} = 3.0\text{ V}$, $f = 1.0\text{ GHz}$	33	38	dB
		$V_{CC} = 3.0\text{ V}$, $f = 2.0\text{ GHz}$	30	—	
		$V_{CC} = 1.8\text{ V}$, $f = 0.5\text{ GHz}$	35	37	
Input Return Loss	RL_{in}	$V_{CC} = 3.0\text{ V}$, $f = 1.0\text{ GHz}$	13.0	10.0	dB
		$V_{CC} = 3.0\text{ V}$, $f = 2.0\text{ GHz}$	14.0	—	
		$V_{CC} = 1.8\text{ V}$, $f = 0.5\text{ GHz}$	6.5	10.0	
Output Return Loss	RL_{out}	$V_{CC} = 3.0\text{ V}$, $f = 1.0\text{ GHz}$	6.5	8.5	dB
		$V_{CC} = 3.0\text{ V}$, $f = 2.0\text{ GHz}$	8.5	—	
		$V_{CC} = 1.8\text{ V}$, $f = 0.5\text{ GHz}$	6.0	9.5	
Saturated Output Power	$P_{O(sat)}$	$V_{CC} = 3.0\text{ V}$, $f = 1.0\text{ GHz}$, $P_{in} = -6\text{ dBm}$	-2.5	-1.0	dBm
		$V_{CC} = 3.0\text{ V}$, $f = 2.0\text{ GHz}$, $P_{in} = -6\text{ dBm}$	-3.5	—	
		$V_{CC} = 1.8\text{ V}$, $f = 0.5\text{ GHz}$, $P_{in} = -10\text{ dBm}$	-11.0	-8.0	
3rd Order Intermodulation Distortion	IM ₃	$V_{CC} = 3.0\text{ V}$, $P_{out} = -10\text{ dBm}$, $f_1 = 500\text{ MHz}$, $f_2 = 502\text{ MHz}$	-30.0	-26.0	dBc
		$V_{CC} = 1.8\text{ V}$, $P_{out} = -20\text{ dBm}$, $f_1 = 500\text{ MHz}$, $f_2 = 502\text{ MHz}$	-31.0	-37.0	
		$V_{CC} = 3.0\text{ V}$, $P_{out} = -10\text{ dBm}$, $f_1 = 1\ 000\text{ MHz}$, $f_2 = 1\ 002\text{ MHz}$	-26.0	—	



TEST CIRCUIT

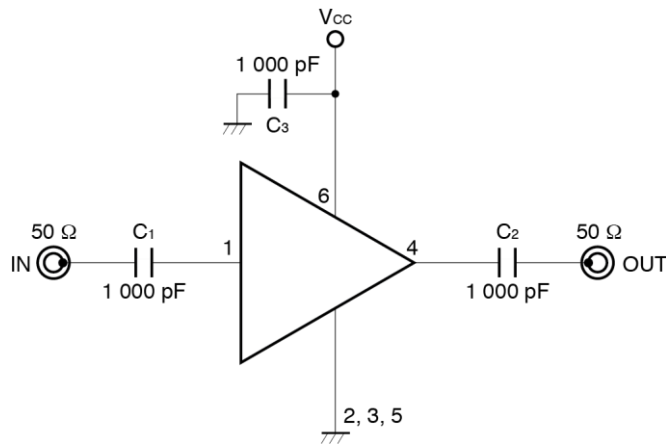

EXAMPLE OF APPLICATION CIRCUIT

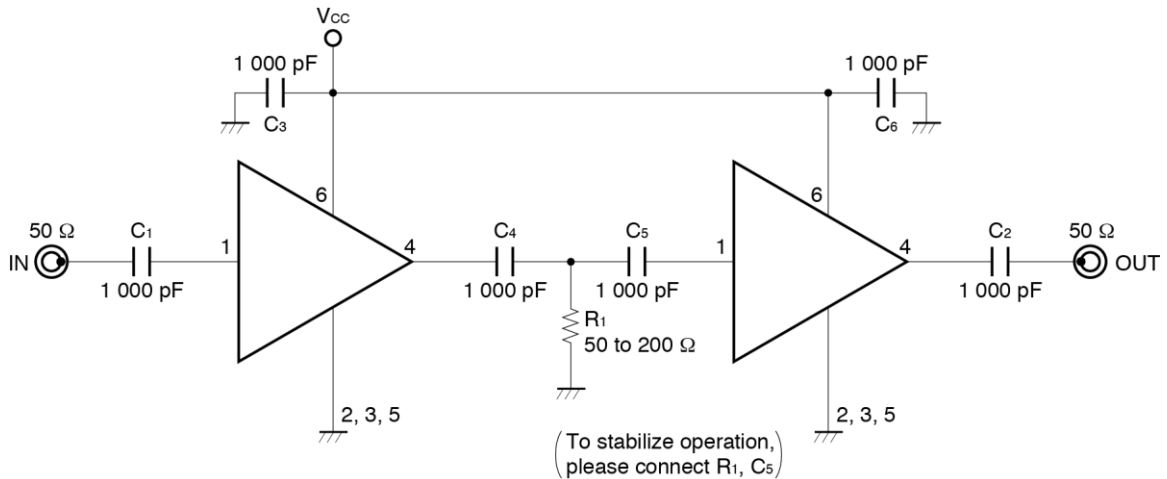

The application circuits and their parameters are for references only and are not intended for use in actual design-ins.

CAPACITORS FOR THE Vcc, INPUT, AND OUTPUT PINS

Capacitors of 1 000 pF are recommendable as the bypass capacitor for the Vcc pin and the coupling capacitors for the input and output pins.

The bypass capacitor connected to the Vcc pin is used to minimize ground impedance of Vcc pin. So, stable bias can be supplied against Vcc fluctuation.

The coupling capacitors, connected to the input and output pins, are used to cut the DC and minimize RF serial impedance. Their capacitance are therefore selected as lower impedance against a 50 Ω load. The capacitors thus perform as high pass filters, suppressing low frequencies to DC.

To obtain a flat gain from 100 MHz upwards, 1 000 pF capacitors are used in the test circuit. In the case of under 10 MHz operation, increase the value of coupling capacitor such as 10 000 pF. Because the coupling capacitors are determined by equation, $f_c = 1/(2\pi RC)$.

ILLUSTRATION OF THE TEST CIRCUIT ASSEMBLED ON EVALUATION BOARD

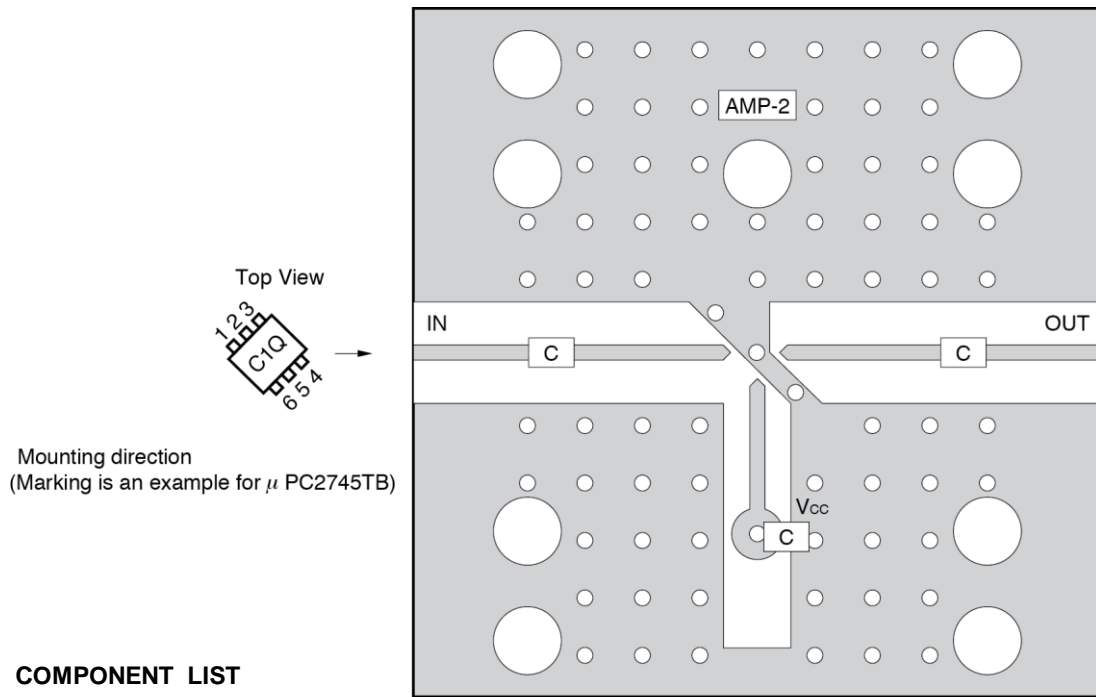

COMPONENT LIST

	Value
C	1 000 pF

Notes

1. 30 × 30 × 0.4 mm double sided copper clad polyimide board.
2. Back side: GND pattern
3. Solder plated on pattern
4. \oplus \oplus \oplus : Through holes

For more information on the use of this IC, refer to the following application note: **USAGE AND APPLICATIONS OF 6-PIN MINI-MOLD, 6-PIN SUPER MINI-MOLD SILICON HIGH-FREQUENCY WIDEBAND AMPLIFIER MMIC (P11976E).**

TYPICAL CHARACTERISTICS ($T_A = +25^\circ\text{C}$, unless otherwise specified)

— μ PC2745TB —

CIRCUIT CURRENT vs. SUPPLY VOLTAGE

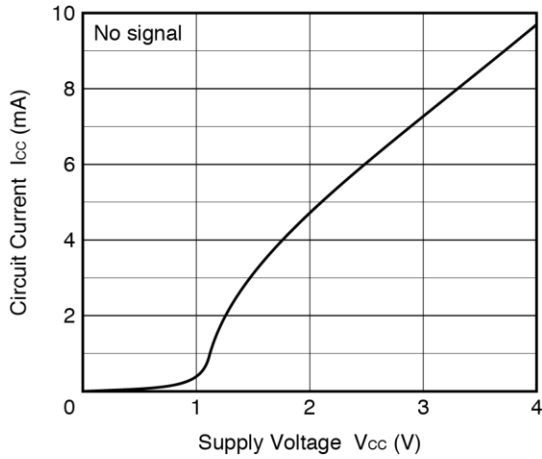

CIRCUIT CURRENT vs. OPERATING AMBIENT TEMPERATURE

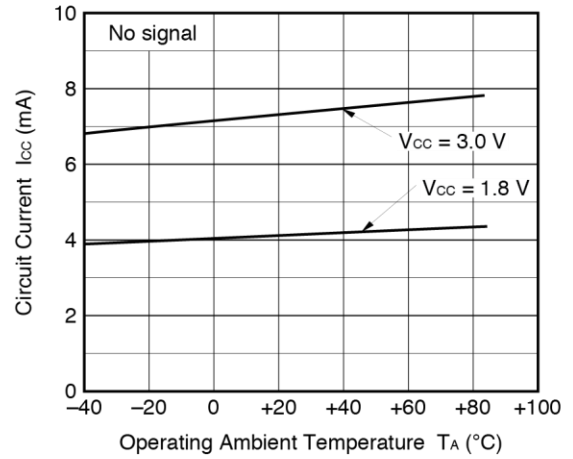

NOISE FIGURE, POWER GAIN vs. FREQUENCY

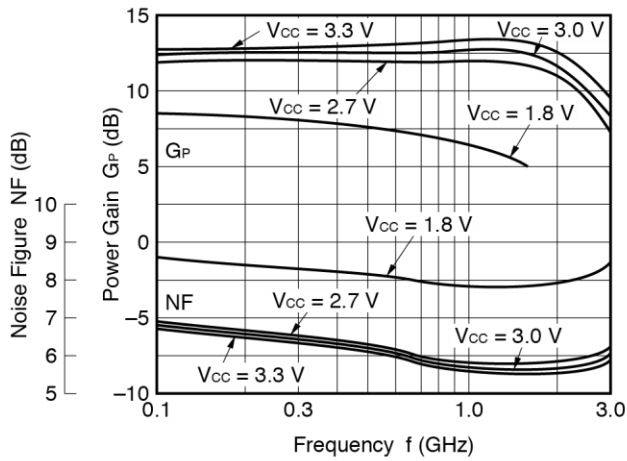

POWER GAIN vs. FREQUENCY

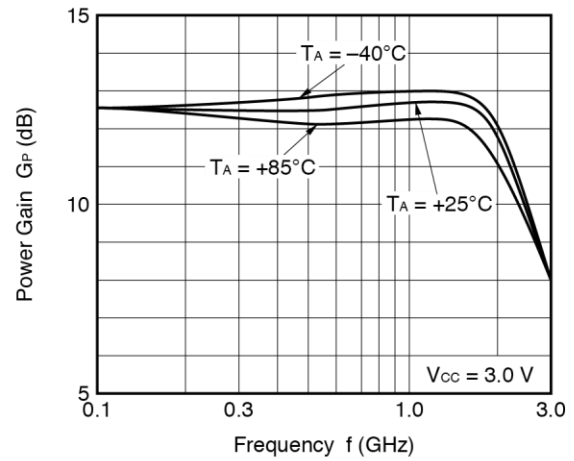

ISOLATION vs. FREQUENCY

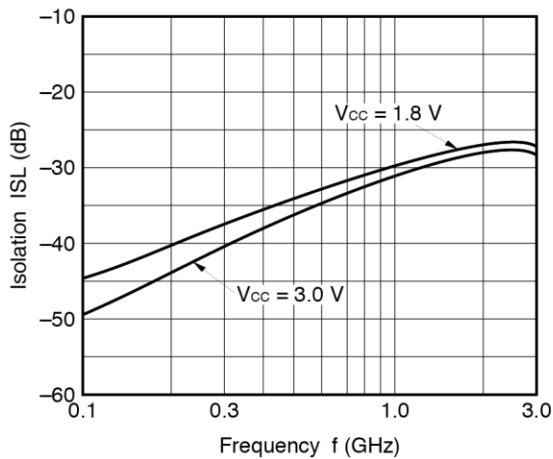

INPUT RETURN LOSS, OUTPUT RETURN LOSS vs. FREQUENCY

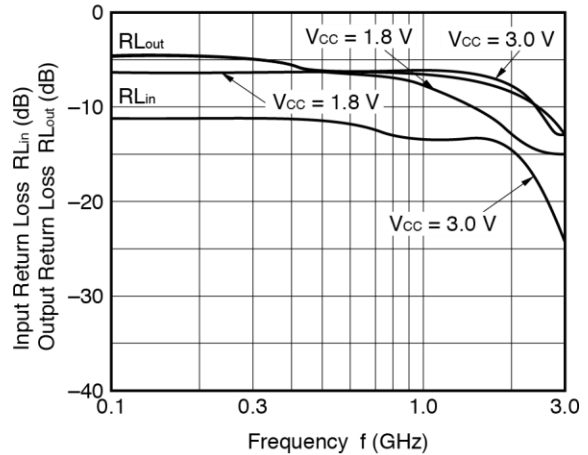

Remark The graphs indicate nominal characteristics.

— μ PC2745TB —

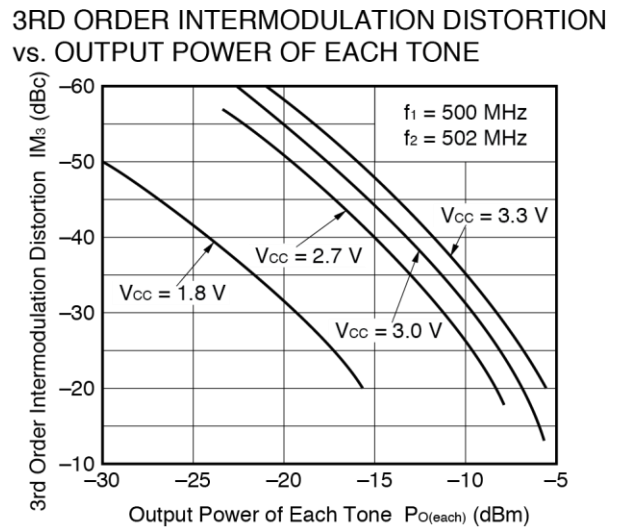
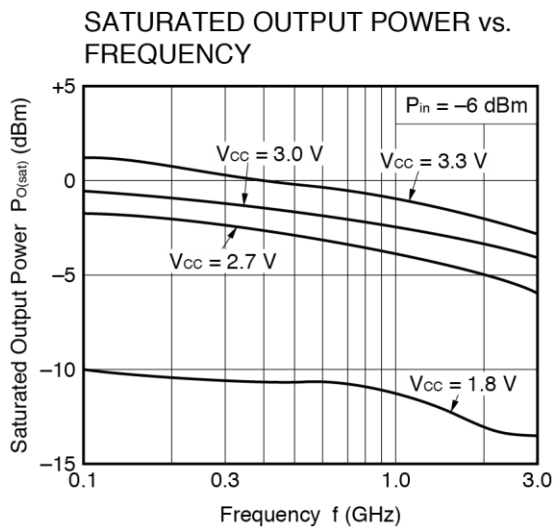
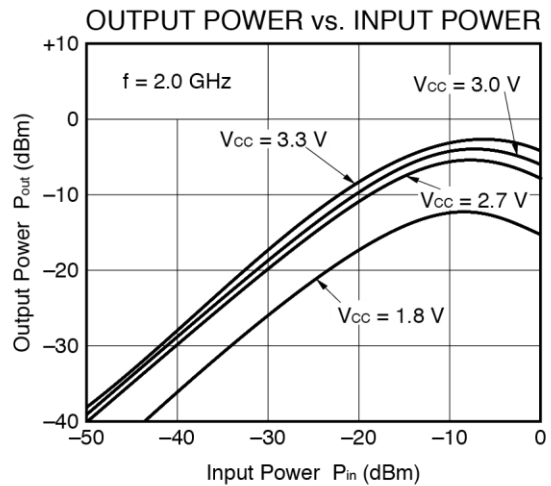
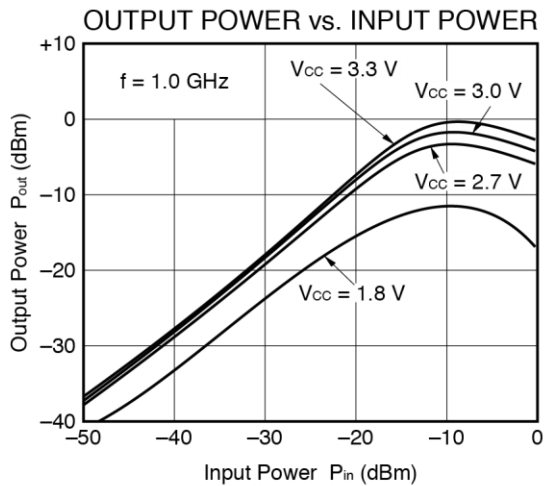
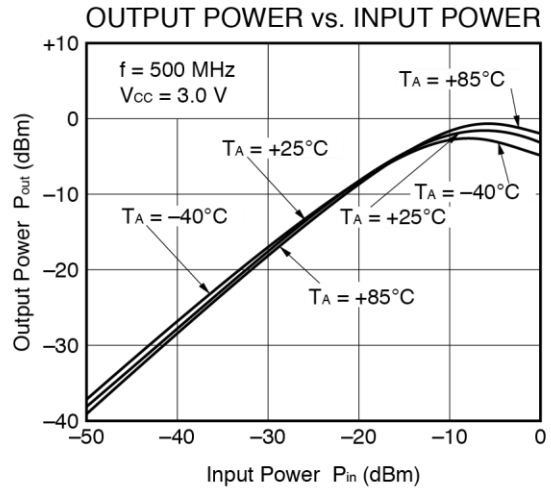
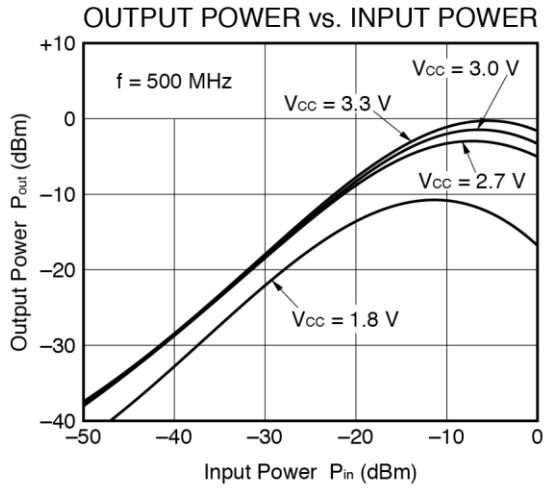

Remark The graphs indicate nominal characteristics.

SMITH CHART ($T_A = +25^\circ\text{C}$, $V_{CC} = 3.0\text{ V}$)

— μ PC2745TB —

S₁₁-FREQUENCY

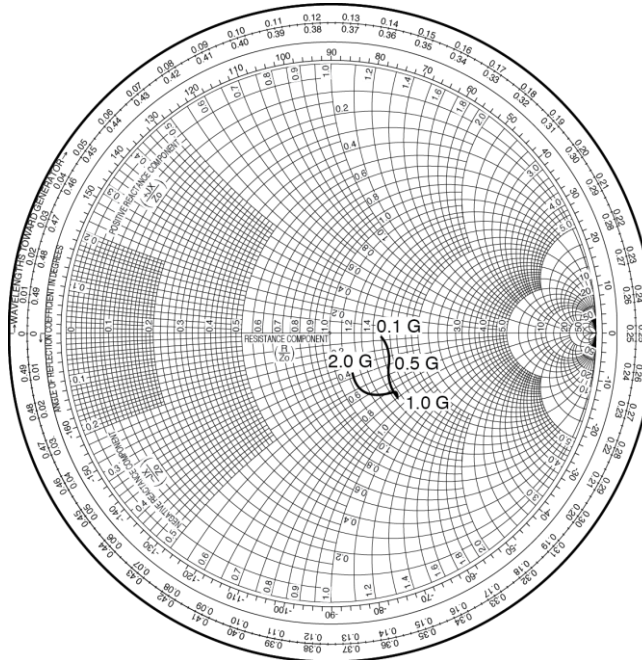

S₂₂-FREQUENCY

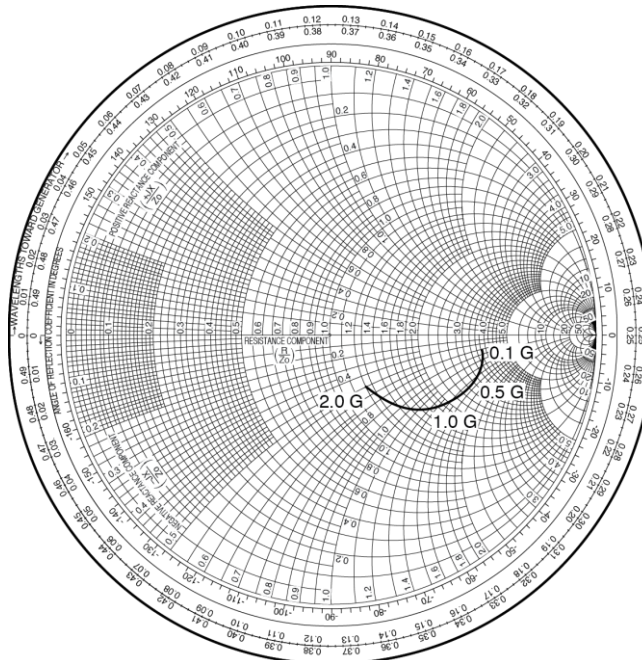

S-PARAMETERS

- S-parameters and noise parameters are provided on our Web site in a format (S2P) that enables the direct import of the parameters to microwave circuit simulators without the need for keyboard inputs.
- [Click here to download S-parameters.](#)
- [RF and Microwave] ® [Device Parameters]
- URL <http://www.necel.com/microwave/en/>

TYPICAL CHARACTERISTICS ($T_A = +25^\circ\text{C}$, unless otherwise specified)

— μ PC2746TB —

CIRCUIT CURRENT vs. SUPPLY VOLTAGE

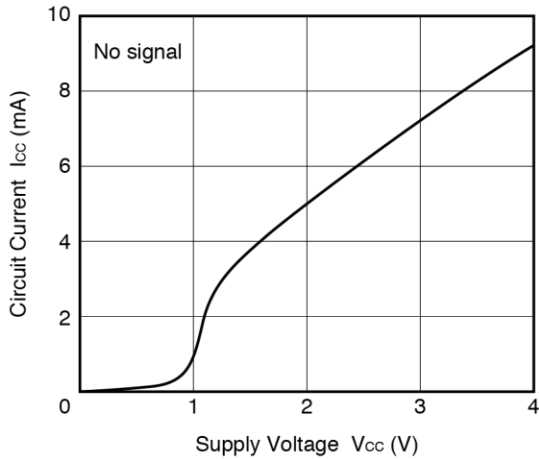

CIRCUIT CURRENT vs. OPERATING AMBIENT TEMPERATURE

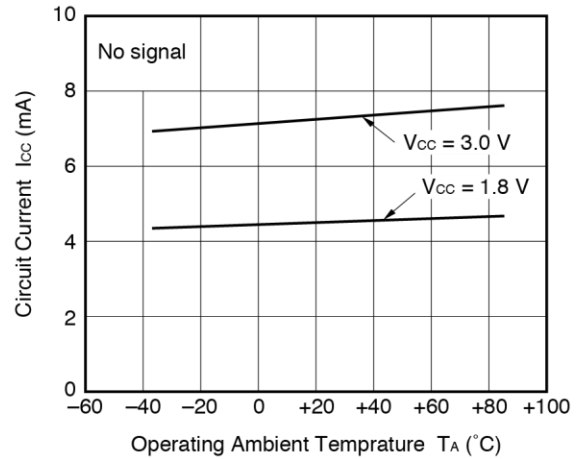

NOISE FIGURE, POWER GAIN vs. FREQUENCY

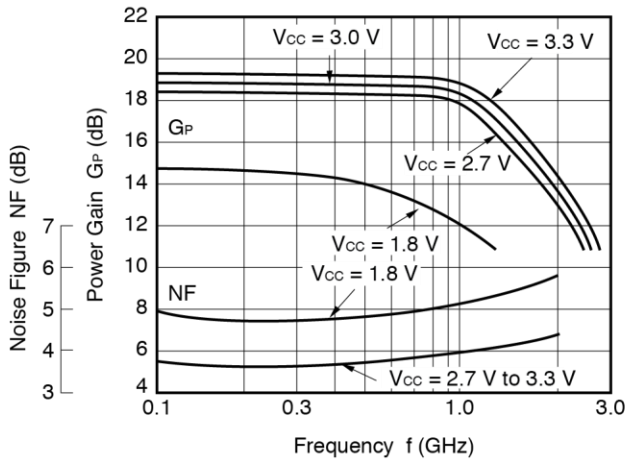

POWER GAIN vs. FREQUENCY

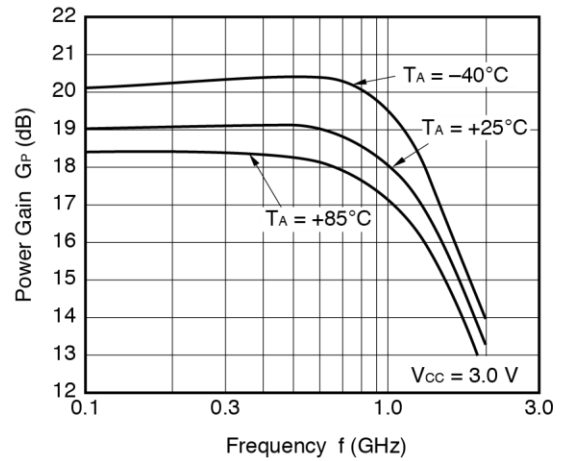

ISOLATION vs. FREQUENCY

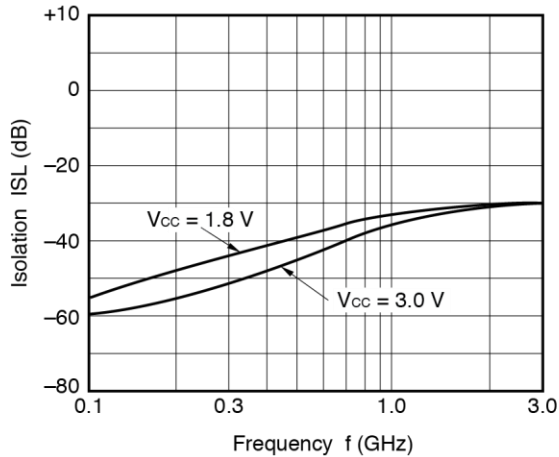

INPUT RETURN LOSS, OUTPUT RETURN LOSS vs. FREQUENCY

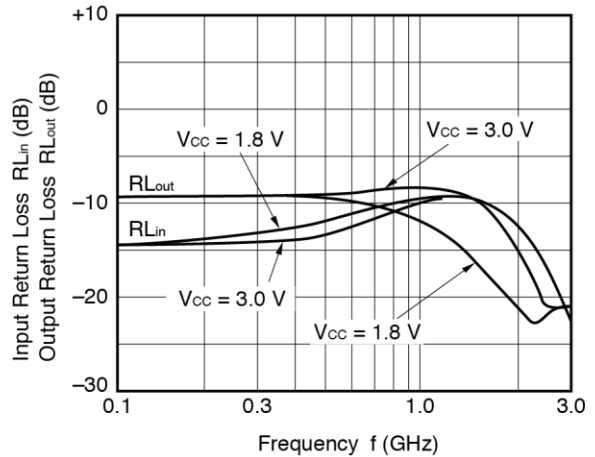

Remark The graphs indicate nominal characteristics.

— μ PC2746TB —

OUTPUT POWER vs. INPUT POWER

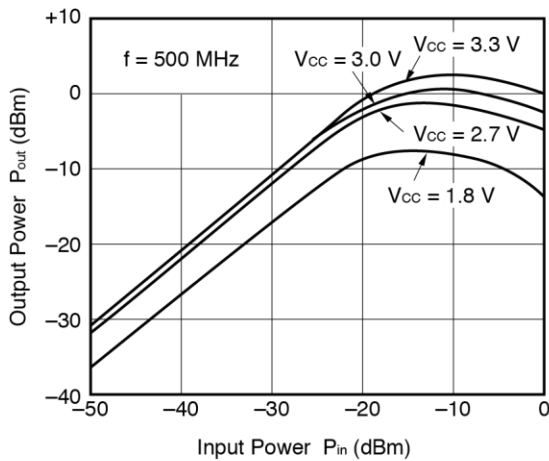

OUTPUT POWER vs. INPUT POWER

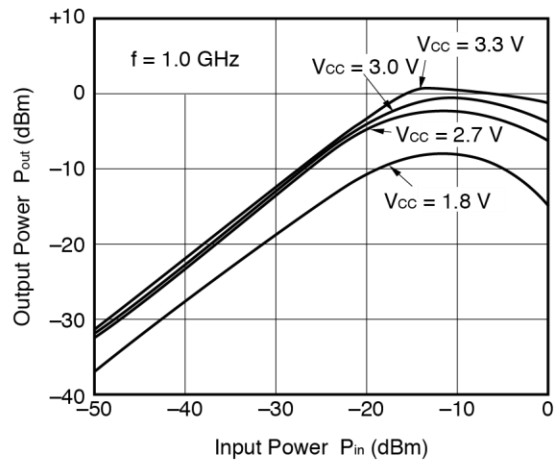

OUTPUT POWER vs. INPUT POWER

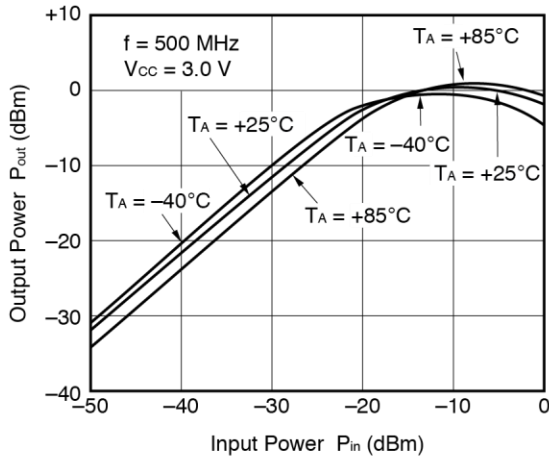

OUTPUT POWER vs. INPUT POWER

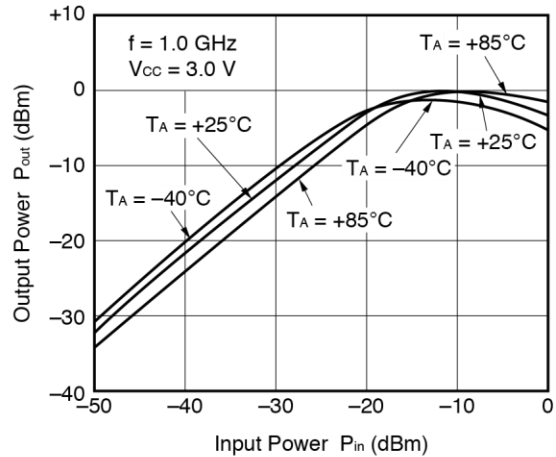

SATURATED OUTPUT POWER vs. FREQUENCY

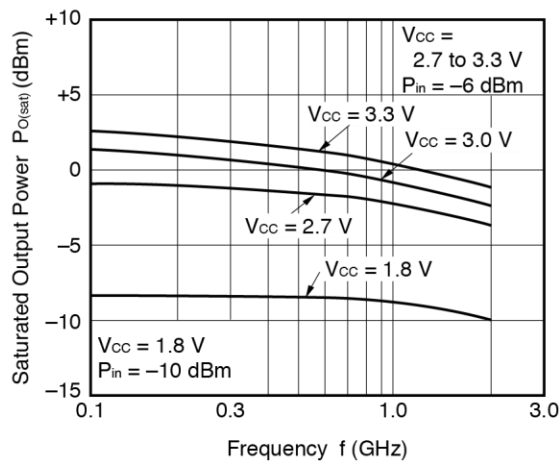

3RD ORDER INTERMODULATION DISTORTION vs. OUTPUT POWER OF EACH TONE

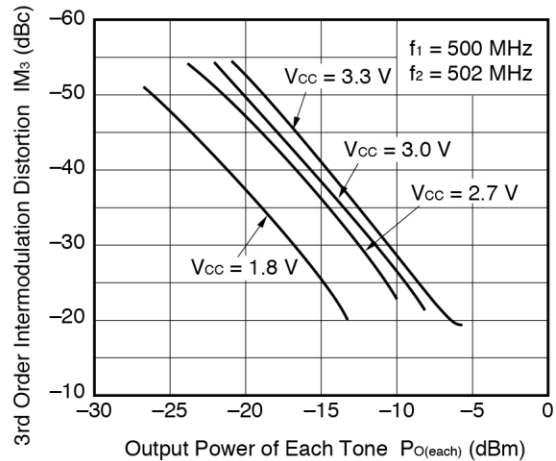

Remark The graphs indicate nominal characteristics.

SMITH CHART ($T_A = +25^\circ\text{C}$, $V_{CC} = 3.0\text{ V}$)

— μ PC2746TB —

S₁₁-FREQUENCY

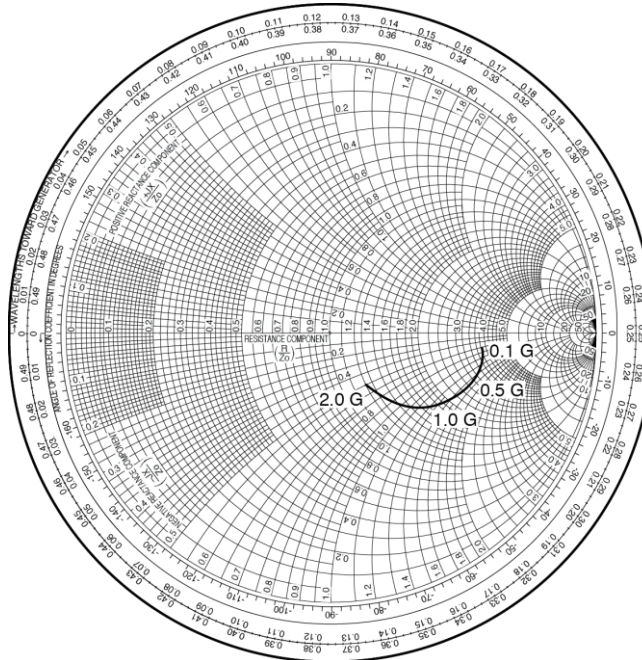

S₂₂-FREQUENCY

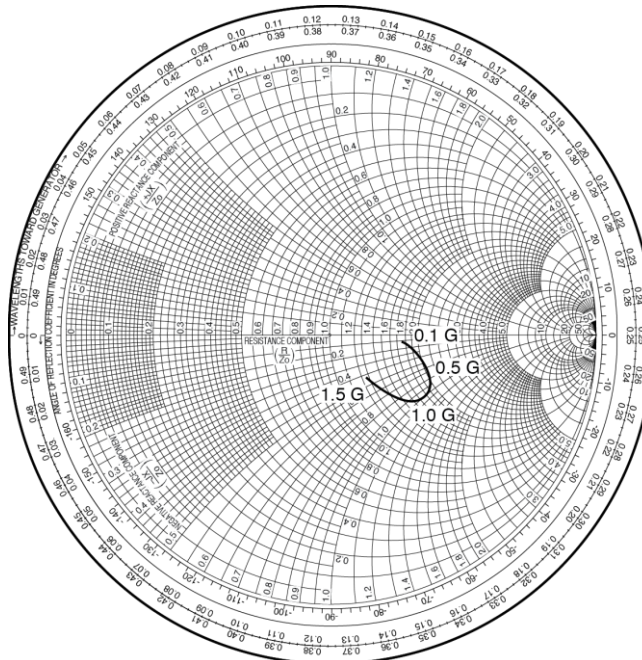

S-PARAMETERS

- S-parameters and noise parameters are provided on our Web site in a format (S2P) that enables the direct import of the parameters to microwave circuit simulators without the need for keyboard inputs.
- [Click here to download S-parameters.](#)
- [RF and Microwave] ® [Device Parameters]
- URL <http://www.necel.com/microwave/en/>

PACKAGE DIMENSIONS

6-PIN SUPER MINIMOLD (UNIT: mm)

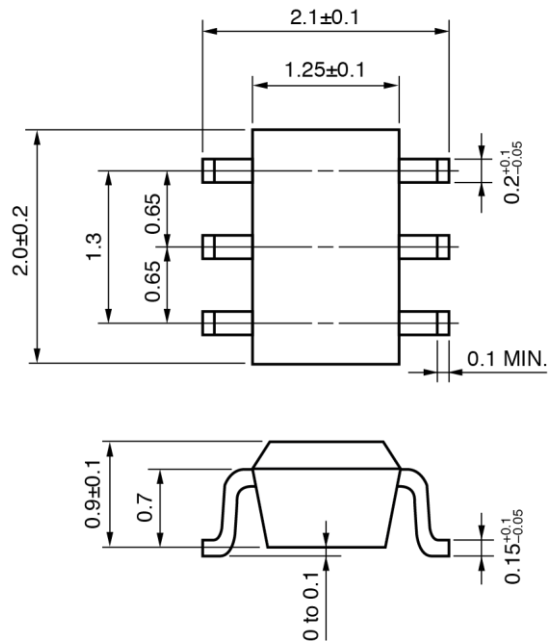

NOTES ON CORRECT USE

- (1) Observe precautions for handling because of electro-static sensitive devices.
- (2) Form a ground pattern as widely as possible to minimize ground impedance (to prevent undesired oscillation).
All the ground pins must be connected together with wide ground pattern to decrease impedance difference.
- (3) The bypass capacitor should be attached to the V_{cc} pin.
- (4) The DC cut capacitor must be attached to input pin and output pin.

RECOMMENDED SOLDERING CONDITIONS

This product should be soldered and mounted under the following recommended conditions. For soldering methods and conditions other than those recommended below, contact your nearby sales office.

Soldering Method	Soldering Conditions	Condition Symbol
Infrared Reflow	Peak temperature (package surface temperature) : 260°C or below Time at peak temperature : 10 seconds or less Time at temperature of 220°C or higher : 60 seconds or less Preheating time at 120 to 180°C : 120±30 seconds Maximum number of reflow processes : 3 times Maximum chlorine content of rosin flux (% mass) : 0.2%(Wt.) or below	IR260
VPS	Peak temperature (package surface temperature) : 215°C or below Time at temperature of 200°C or higher : 25 to 40 seconds Preheating time at 120 to 150°C : 30 to 60 seconds Maximum number of reflow processes : 3 times Maximum chlorine content of rosin flux (% mass) : 0.2%(Wt.) or below	VP215
Wave Soldering	Peak temperature (molten solder temperature) : 260°C or below Time at peak temperature : 10 seconds or less Preheating temperature (package surface temperature) : 120°C or below Maximum number of flow processes : 1 time Maximum chlorine content of rosin flux (% mass) : 0.2%(Wt.) or below	WS260
Partial Heating	Peak temperature (pin temperature) : 350°C or below Soldering time (per side of device) : 3 seconds or less Maximum chlorine content of rosin flux (% mass) : 0.2%(Wt.) or below	HS350

Caution Do not use different soldering methods together (except for partial heating).

Данный компонент на территории Российской Федерации

Вы можете приобрести в компании MosChip.

Для оперативного оформления запроса Вам необходимо перейти по данной ссылке:

<http://moschip.ru/get-element>

Вы можете разместить у нас заказ для любого Вашего проекта, будь то серийное производство или разработка единичного прибора.

В нашем ассортименте представлены ведущие мировые производители активных и пассивных электронных компонентов.

Нашей специализацией является поставка электронной компонентной базы двойного назначения, продукции таких производителей как XILINX, Intel (ex.ALTERA), Vicor, Microchip, Texas Instruments, Analog Devices, Mini-Circuits, Amphenol, Glenair.

Сотрудничество с глобальными дистрибьюторами электронных компонентов, предоставляет возможность заказывать и получать с международных складов практически любой перечень компонентов в оптимальные для Вас сроки.

На всех этапах разработки и производства наши партнеры могут получить квалифицированную поддержку опытных инженеров.

Система менеджмента качества компании отвечает требованиям в соответствии с ГОСТ Р ИСО 9001, ГОСТ РВ 0015-002 и ЭС РД 009

Офис по работе с юридическими лицами:

105318, г.Москва, ул.Щербаковская д.3, офис 1107, 1118, ДЦ «Щербаковский»

Телефон: +7 495 668-12-70 (многоканальный)

Факс: +7 495 668-12-70 (доб.304)

E-mail: info@moschip.ru

Skype отдела продаж:

moschip.ru

moschip.ru_4

moschip.ru_6

moschip.ru_9