

RO3144E/E-1/E-2

916.5 MHz SAW Resonator

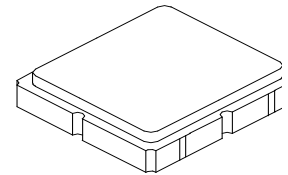

**SM3030-6 Case
3.0 X 3.0**

- Ideal for 916.5 MHz Remote Control and Data Telemetry Transmitters
- Very Low Series Resistance
- Quartz Stability
- Complies with Directive 2002/95/EC (RoHS)



The RO3144E is a true one-port, surface-acoustic-wave (SAW) resonator in a surface-mount ceramic case. It provides reliable, fundamental-mode stabilization of fixed-frequency transmitters operating at 916.5 MHz. This SAW is designed specifically for remote control and data telemetry transmitters operating in the USA under FCC Part 15 regulations and in Canada under DoC RSS-210.

Absolute Maximum Ratings

Rating	Value	Units
Input Power Level	0	dBm
DC Voltage	12	VDC
Storage Temperature	-40 to +125	°C
Operating Temperature Range	-40 to +125	°C
Soldering Temperature	260	°C

Electrical Characteristics

Characteristic	Sym	Notes	Minimum	Typical	Maximum	Units	
Frequency, +25 °C	RO3144E	2, 3, 4, 5	916.300		916.700	MHz	
	RO3144E-1		916.350		916.650		
	RO3144E-2		916.400		916.600		
Tolerance from 916.5 MHz	RO3144E	Δf _C			±200	kHz	
	RO3144E-1				±150		
	RO3144E-2				±100		
Insertion Loss		IL	2, 5, 6	1.2	1.6	dB	
Quality Factor	Unloaded Q	Q _U	5, 6, 7	6400			
	50 Ω Loaded Q	Q _L		780			
Temperature Stability	Turnover Temperature	T _O	6, 7, 8	15	25	40	°C
	Turnover Frequency	f _O			f _c		MHz
	Frequency Temperature Coefficient	FTC			0.032		ppm/°C ²
Frequency Aging	Absolute Value during the First Year	fA	1	10		ppm	
DC Insulation Resistance between Any Two Terminals			5	1.0		MΩ	
RF Equivalent RLC Model	Motional Resistance	R _M	5, 6, 7, 9	14		Ω	
	Motional Inductance	L _M		15.4		μH	
	Motional Capacitance	C _M		1.9		fF	
	Transducer Static Capacitance	C _O		1.9		pF	
Test Fixture Shunt Inductance		L _{TEST}	2, 7	16		nH	
Lid Symbolization			RO3144E 693, RO3144E-1 769, RO3144E-2 770 / YWWS				
Standard Reel Quantity	Reel Size 7 Inch		10	500 Pieces / Reel			
	Reel Size 13 Inch			3000 Pieces / Reel			



CAUTION: Electrostatic Sensitive Device. Observe precautions for handling.

NOTES:

- Frequency aging is the change in f_C with time and is specified at +65 °C or less. Aging may exceed the specification for prolonged temperatures above +65 °C. Typically, aging is greatest the first year after manufacture, decreasing in subsequent years.
- The center frequency, f_C, is measured at the minimum insertion loss point, IL_{MIN}, with the resonator in the 50 Ω test system (VSWR ≤ 1.2:1). The shunt inductance, L_{TEST}, is tuned for parallel resonance with C_O at f_C. Typically, f_{OSCILLATOR} or f_{TRANSMITTER} is approximately equal to the resonator f_C.
- One or more of the following United States patents apply: 4,454,488 and 4,616,197.
- Typically, equipment utilizing this device requires emissions testing and government approval, which is the responsibility of the equipment manufacturer.
- Unless noted otherwise, case temperature T_C = +25 ± 2 °C.
- The design, manufacturing process, and specifications of this device are subject to change without notice.
- Derived mathematically from one or more of the following directly measured parameters: f_C, IL, 3 dB bandwidth, f_C versus T_C, and C_O.
- Turnover temperature, T_O, is the temperature of maximum (or turnover) frequency, f_O. The nominal frequency at any case temperature, T_C, may be calculated from:
f = f_O [1 - FTC (T_O - T_C)²]. Typically oscillator T_O is approximately equal to the specified resonator T_O.
- This equivalent RLC model approximates resonator performance near the resonant frequency and is provided for reference only. The capacitance C_O is the static (nonmotional) capacitance between the two terminals measured at low frequency (10 MHz) with a capacitance meter. The measurement includes parasitic capacitance with "NC" pads unconnected. Case parasitic capacitance is approximately 0.05 pF. Transducer parallel capacitance can be calculated as: C_P ≈ C_O - 0.05 pF.
- Tape and Reel Standard for ANSI / EIA 481.

Electrical Connections

The SAW resonator is bidirectional and may be installed with either orientation. The two terminals are interchangeable and unnumbered. The callout NC indicates no internal connection. The NC pads assist with mechanical positioning and stability. External grounding of the NC pads is recommended to help reduce parasitic capacitance in the circuit.

Pin	Connection
1	NC
2	Terminal
3	NC
4	NC
5	Terminal
6	NC

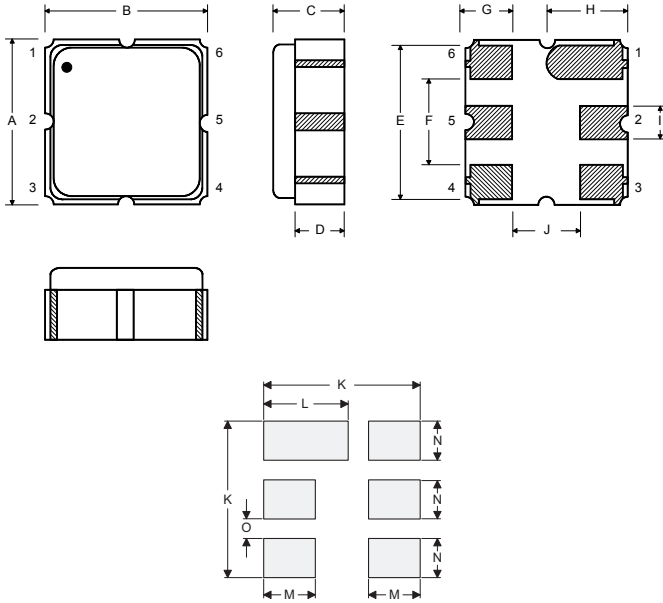

Case and Typical PCB Land Dimensions

Ref	mm			Inches		
	Min	Nom	Max	Min	Nom	Max
A	2.87	3.00	3.13	0.113	0.118	0.123
B	2.87	3.00	3.13	0.113	0.118	0.123
C	1.12	1.25	1.38	0.044	0.049	0.054
D	0.77	0.90	1.03	0.030	0.035	0.040
E	2.67	2.80	2.93	0.105	0.110	0.115
F	1.47	1.60	1.73	0.058	0.063	0.068
G	0.72	0.85	0.98	0.028	0.033	0.038
H	1.37	1.50	1.63	0.054	0.059	0.064
I	0.47	0.60	0.73	0.019	0.024	0.029
J	1.17	1.30	1.43	0.046	0.051	0.056
K		3.20			0.126	
L		1.70			0.067	
M		1.05			0.041	
N		0.81			0.032	
O		0.38			0.015	

Equivalent RLC Model



Temperature Characteristics

The curve shown accounts for resonator contribution only and does not include external LC component temperature effects.

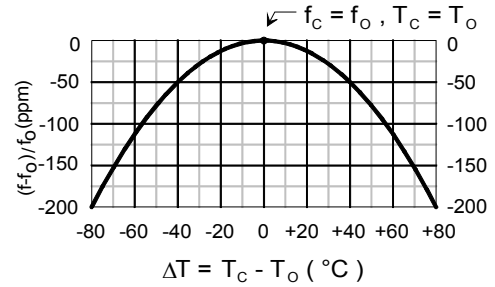

Characterization Test Circuit

Inductor L_{TEST} is tuned to resonate with the static capacitance, C_0 , at F_c .

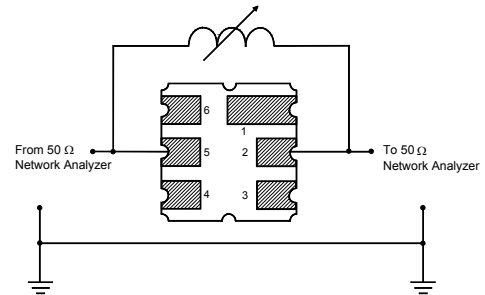

Power Dissipation Test

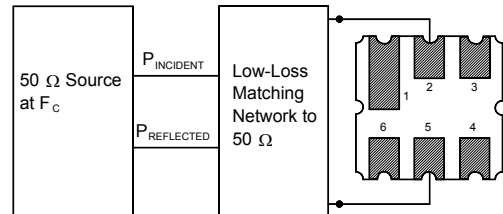

Example Application Circuits

Typical Low-Power Transmitter Application

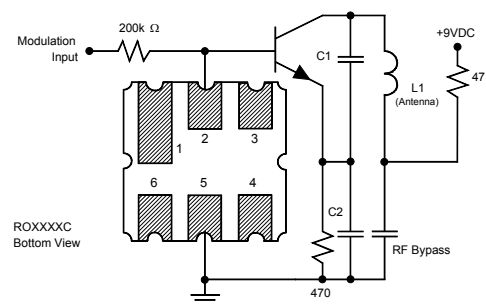

Typical Local Oscillator Application

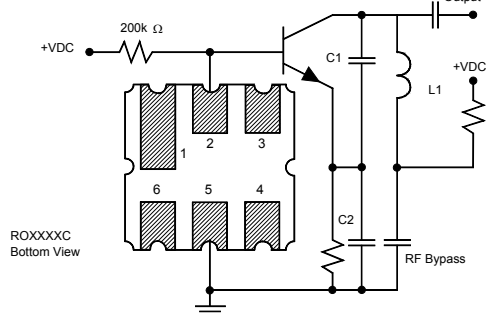

Данный компонент на территории Российской Федерации

Вы можете приобрести в компании MosChip.

Для оперативного оформления запроса Вам необходимо перейти по данной ссылке:

<http://moschip.ru/get-element>

Вы можете разместить у нас заказ для любого Вашего проекта, будь то серийное производство или разработка единичного прибора.

В нашем ассортименте представлены ведущие мировые производители активных и пассивных электронных компонентов.

Нашей специализацией является поставка электронной компонентной базы двойного назначения, продукции таких производителей как XILINX, Intel (ex.ALTERA), Vicor, Microchip, Texas Instruments, Analog Devices, Mini-Circuits, Amphenol, Glenair.

Сотрудничество с глобальными дистрибьюторами электронных компонентов, предоставляет возможность заказывать и получать с международных складов практически любой перечень компонентов в оптимальные для Вас сроки.

На всех этапах разработки и производства наши партнеры могут получить квалифицированную поддержку опытных инженеров.

Система менеджмента качества компании отвечает требованиям в соответствии с ГОСТ Р ИСО 9001, ГОСТ РВ 0015-002 и ЭС РД 009

Офис по работе с юридическими лицами:

105318, г.Москва, ул.Щербаковская д.3, офис 1107, 1118, ДЦ «Щербаковский»

Телефон: +7 495 668-12-70 (многоканальный)

Факс: +7 495 668-12-70 (доб.304)

E-mail: info@moschip.ru

Skype отдела продаж:

moschip.ru

moschip.ru_4

moschip.ru_6

moschip.ru_9