

THIS COPY IS PROVIDED ON A RESTRICTED BASIS AND IS NOT TO BE USED IN ANY WAY DETRIMENTAL TO THE INTERESTS OF PANDUIT CORP.

NOTES:

1. SEE SHEETS 2, 3 & 4 FOR PRODUCT DESCRIPTIONS AND TECHNICAL SPECIFICATIONS.
2. SEE CURRENT CATALOG FOR PATCH CORD LENGTHS AND PACKAGE QUANTITIES.
3. FOR LENGTHS OTHER THAN THOSE LISTED IN CATALOG, CONTACT YOUR PANDUIT SALES PERSON.
4. TESTED TO EIA/TIA 568-C.3.
5. PATCH CORD ROUTING CONFIGURATION A TO B.
6. ALL MATERIALS AND COMPONENTS USED MEET THE MATERIAL RESTRICTIONS OF RoHS, (EUROPEAN DIRECTIVE 2002/95/EC ON THE RESTRICTION OF HAZARDOUS SUBSTANCES) AS PROPOSED BY THE RoHS TECHNICAL ADAPTATION COMMITTEE.

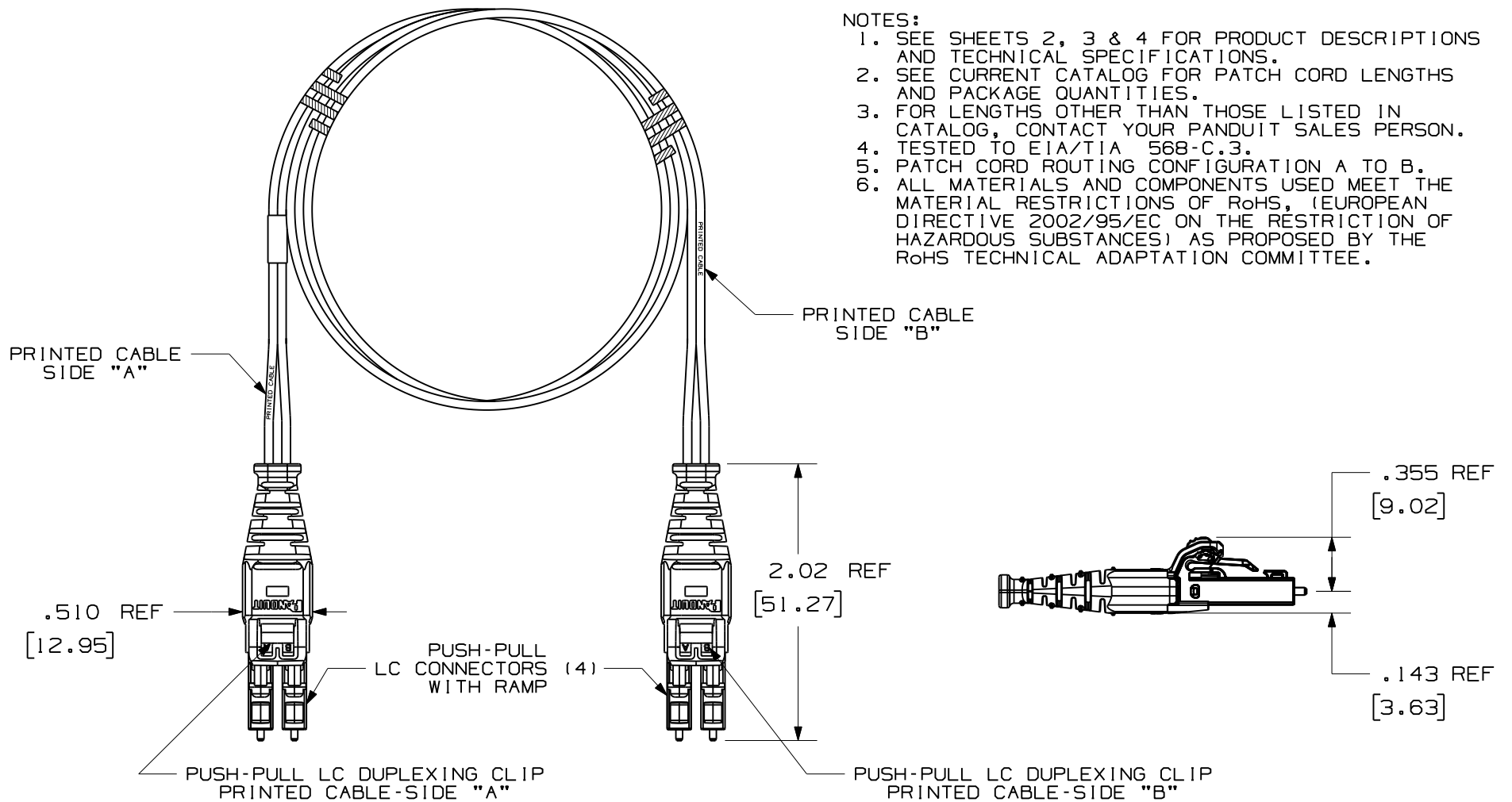

FIBER OPTIC PATCH CORD
 DUPLEX LC PUSH-PULL TO LC PUSH-PULL
 CUSTOMER DRAWING



PANDUIT™
 CORP.
 TINLEY PARK, ILL 60477

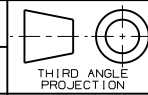

ALL DIMENSIONS ARE GIVEN IN INCHES
 UNLESS OTHERWISE SPECIFIED.
 DIMENSIONAL TOLERANCES ARE:
 (.X) ±.03 | (.XXX) ±.010 | (.3)
 (.XX) ±.03 | (.8) ANGLES

DRAWING FILENAME
 10F119BE_DC/00A

SCALE
 NONE

DRAWN BY
 SAT

REVIEW DRAWING NUMBERS

PART NO.
 SEE SHEETS 2, 3 & 4

REV	DATE	BY	CHK	DESCRIPTION	ECN	R	CUST	SUP	OTH
R	10-12-12	SAT	PJI	RELEASED TO PRODUCTION	10F119BE-DC				

DATE
 10-08-12

CHK'D
 PJI

DRAWING NO.
 10F119BE-DC

SIZE
 A

SHEET 1 OF 4

THIS COPY IS PROVIDED ON A RESTRICTED BASIS AND IS NOT TO BE USED IN ANY WAY DETRIMENTAL TO THE INTERESTS OF PANDUIT CORP.

DUPLEX LC PUSH-PULL TO LC PUSH-PULL FIBER OPTIC PATCH CORD					
PANDUIT PART NO.	CABLE				LC CONNECTOR
	RATING	FIBER TYPE	COUNT	COLOR	BOOT COLOR
FX2ERQNQNSNM***	RISER (OFNR)	10GbE OM3	DUPLEX 1.6mm ZIPCORD	AQUA	AQUA
FZ2ERQNQNSNM***		10GbE OM4		AQUA	AQUA
F92ERQNQNSNM***		9/125um OS1		YELLOW	BLUE

*** - DENOTES PATCH CORD LENGTH, WHERE M = METERS

REV	DATE	BY	CHK	DESCRIPTION	ECN	R	CUST	SUP	OTH
R	10-12-12	SAT	PJI	RELEASED TO PRODUCTION	10F119BE-DC				

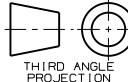
FIBER OPTIC PATCH CORD DUPLEX LC PUSH-PULL TO LC PUSH-PULL CUSTOMER DRAWING									
				PANDUIT ™ CORP. TINLEY PARK, ILL 60477					
 THIRD ANGLE PROJECTION				ALL DIMENSIONS ARE GIVEN IN INCHES UNLESS OTHERWISE SPECIFIED. DIMENSIONAL TOLERANCES ARE: (.X) ±.03 (.XXX) ±.010 (.3)				DRAWING FILENAME 10F119BE_DC/00A	
				(.XX) ±.03 (.8) ANGLES				SCALE NONE	
				DRAWN BY SAT				REVIEW DRAWING NUMBERS	
				DATE 10-08-12				PART NO. SEE SHEETS 2, 3 & 4	
				CHK'D PJI				DRAWING NO. 10F119BE-DC SHEET 2 OF 4	
								SIZE A	

THIS COPY IS PROVIDED ON A RESTRICTED BASIS AND IS NOT TO BE USED IN ANY WAY DETRIMENTAL TO THE INTERESTS OF PANDUIT CORP.

DUPLEX LC PUSH-PULL TO LC PUSH-PULL FIBER OPTIC PATCH CORD					
PANDUIT PART NO.	CABLE				LC CONNECTOR
	RATING	FIBER TYPE	COUNT	COLOR	BOOT COLOR
FX2EPQNSNM***	PLENUM (OFNP)	10GbE OM3	DUPLEX 1.6mm ZIPCORD	AQUA	AQUA
FZ2EPQNSNM***		10GbE OM4		AQUA	AQUA
F92EPQNSNM***		9/125um OS1		YELLOW	BLUE

*** - DENOTES PATCH CORD LENGTH, WHERE M = METERS

REV	DATE	BY	CHK	DESCRIPTION	ECN	R	CUST	SUP	OTH
R	10-12-12	SAT	PJI	RELEASED TO PRODUCTION	10F119BE-DC				

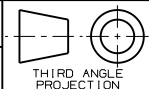
FIBER OPTIC PATCH CORD DUPLEX LC PUSH-PULL TO LC PUSH-PULL CUSTOMER DRAWING											
		PANDUIT ™ CORP. TINLEY PARK, ILL 60477									
 THIRD ANGLE PROJECTION		ALL DIMENSIONS ARE GIVEN IN INCHES UNLESS OTHERWISE SPECIFIED. DIMENSIONAL TOLERANCES ARE: (.X) ±.03 (.XXX) ±.010 (.3)				DRAWING FILENAME 10F119BE_DC/00A SCALE NONE					
DRAWN BY		SAT		REVIEW DRAWING NUMBERS				PART NO.		SEE SHEETS 2, 3 & 4	
DATE		10-08-12		DRAWING NO.				10F119BE-DC		SIZE	
CHK'D		PJI		SHEET 3 OF 4						A	

THIS COPY IS PROVIDED ON A RESTRICTED BASIS AND IS NOT TO BE USED IN ANY WAY DETRIMENTAL TO THE INTERESTS OF PANDUIT CORP.

DUPLEX LC PUSH-PULL TO LC PUSH-PULL FIBER OPTIC PATCH CORD					
PANDUIT PART NO.	CABLE				LC CONNECTOR
	RATING	FIBER TYPE	COUNT	COLOR	BOOT COLOR
FX2ELQNQNSNM***	LOW SMOKE ZERO HALOGEN (LSZH) IEC	10GbE OM3	DUPLEX 1.6mm ZIPCORD	AQUA	AQUA
FZ2ELQNQNSNM***		10GbE OM4		AQUA	AQUA
F92ELQNQNSNM***		9/125um OS1		YELLOW	BLUE

*** - DENOTES PATCH CORD LENGTH, WHERE M = METERS

REV	DATE	BY	CHK	DESCRIPTION	ECN	R	CUST	SUP	OTH
R	10-12-12	SAT		RELEASED TO PRODUCTION	10F119BE-DC				

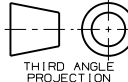
FIBER OPTIC PATCH CORD DUPLEX LC PUSH-PULL TO LC PUSH-PULL CUSTOMER DRAWING									
				PANDUIT TM CORP. TINLEY PARK, ILL 60477					
 THIRD ANGLE PROJECTION				ALL DIMENSIONS ARE GIVEN IN INCHES UNLESS OTHERWISE SPECIFIED. DIMENSIONAL TOLERANCES ARE: (.X) ±.03 (.XXX) ±.010 (.3) ±.005 ANGLES				DRAWING FILENAME 10F119BE_DC/00A	
				DRAWN BY: SAT DATE: 10-08-12 CHK'D: PJI				SCALE: NONE	
				REVIEW DRAWING NUMBERS				PART NO. SEE SHEETS 2, 3 & 4	
								DRAWING NO. 10F119BE-DC SHEET 4 OF 4	
								SIZE A	

Данный компонент на территории Российской Федерации

Вы можете приобрести в компании MosChip.

Для оперативного оформления запроса Вам необходимо перейти по данной ссылке:

<http://moschip.ru/get-element>

Вы можете разместить у нас заказ для любого Вашего проекта, будь то серийное производство или разработка единичного прибора.

В нашем ассортименте представлены ведущие мировые производители активных и пассивных электронных компонентов.

Нашей специализацией является поставка электронной компонентной базы двойного назначения, продукции таких производителей как XILINX, Intel (ex.ALTERA), Vicor, Microchip, Texas Instruments, Analog Devices, Mini-Circuits, Amphenol, Glenair.

Сотрудничество с глобальными дистрибьюторами электронных компонентов, предоставляет возможность заказывать и получать с международных складов практически любой перечень компонентов в оптимальные для Вас сроки.

На всех этапах разработки и производства наши партнеры могут получить квалифицированную поддержку опытных инженеров.

Система менеджмента качества компании отвечает требованиям в соответствии с ГОСТ Р ИСО 9001, ГОСТ РВ 0015-002 и ЭС РД 009

Офис по работе с юридическими лицами:

105318, г.Москва, ул.Щербаковская д.3, офис 1107, 1118, ДЦ «Щербаковский»

Телефон: +7 495 668-12-70 (многоканальный)

Факс: +7 495 668-12-70 (доб.304)

E-mail: info@moschip.ru

Skype отдела продаж:

moschip.ru

moschip.ru_4

moschip.ru_6

moschip.ru_9