

FDD6644/FDU6644

30V N-Channel PowerTrench® MOSFET

General Description

This N-Channel MOSFET has been designed specifically to improve the overall efficiency of DC/DC converters using either synchronous or conventional switching PWM controllers. It has been optimized for low gate charge, low $R_{DS(ON)}$ and fast switching speed.

Applications

- DC/DC converter

Features

- 67 A, 30 V. $R_{DS(ON)} = 8.5 \text{ m}\Omega @ V_{GS} = 10 \text{ V}$
 $R_{DS(ON)} = 10.5 \text{ m}\Omega @ V_{GS} = 4.5 \text{ V}$
- High performance trench technology for extremely low $R_{DS(ON)}$
- Low gate charge (25 nC typical)
- High power and current handling capability

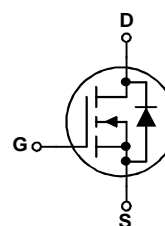
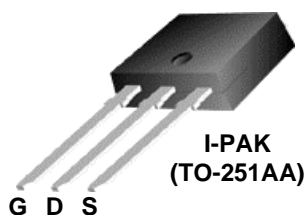
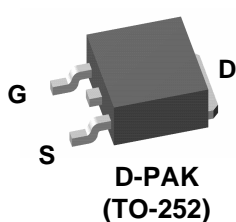

Absolute Maximum Ratings $T_A=25^\circ\text{C}$ unless otherwise noted

Symbol	Parameter	Ratings	Units
V_{DSS}	Drain-Source Voltage	30	V
V_{GSS}	Gate-Source Voltage	± 16	V
I_D	Drain Current – Continuous (Note 1a)	67	A
	– Pulsed	100	
P_D	Maximum Power Dissipation (Note 1)	68	W
		3.8	
		1.6 (Note 1b)	
T_J, T_{STG}	Operating and Storage Junction Temperature Range	-55 to +175	$^\circ\text{C}$

Thermal Characteristics

$R_{\theta JC}$	Thermal Resistance, Junction-to-Case (Note 1)	2.2	$^\circ\text{C/W}$
$R_{\theta JA}$	Thermal Resistance, Junction-to-Ambient (Note 1b)	96	$^\circ\text{C/W}$

Package Marking and Ordering Information

Device Marking	Device	Package	Reel Size	Tape width	Quantity
FDD6644	FDD6644	D-PAK (TO-252)	13"	12mm	2500 units
FDU6644	FDU6644	I-PAK (TO-251)	Tube	N/A	75

Electrical Characteristics $T_A = 25^\circ\text{C}$ unless otherwise noted

Symbol	Parameter	Test Conditions	Min	Typ	Max	Units
Drain-Source Avalanche Ratings (Note 2)						
W_{DSS}	Drain-Source Avalanche Energy	Single Pulse, $V_{DD} = 15\text{ V}$, $I_D = 17\text{ A}$			240	mJ
I_{AR}	Drain-Source Avalanche Current				17	A
Off Characteristics						
BV_{DSS}	Drain-Source Breakdown Voltage	$V_{GS} = 0\text{ V}$, $I_D = 250\ \mu\text{A}$	30			V
$\frac{\Delta BV_{DSS}}{\Delta T_J}$	Breakdown Voltage Temperature Coefficient	$I_D = 250\ \mu\text{A}$, Referenced to 25°C		27		mV/ $^\circ\text{C}$
I_{DSS}	Zero Gate Voltage Drain Current	$V_{DS} = 24\text{ V}$, $V_{GS} = 0\text{ V}$			1	μA
I_{GSSF}	Gate-Body Leakage, Forward	$V_{GS} = 16\text{ V}$, $V_{DS} = 0\text{ V}$			100	nA
I_{GSSR}	Gate-Body Leakage, Reverse	$V_{GS} = -16\text{ V}$, $V_{DS} = 0\text{ V}$			-100	nA
On Characteristics (Note 2)						
$V_{GS(th)}$	Gate Threshold Voltage	$V_{DS} = V_{GS}$, $I_D = 250\ \mu\text{A}$	1	1.5	3	V
$\frac{\Delta V_{GS(th)}}{\Delta T_J}$	Gate Threshold Voltage Temperature Coefficient	$I_D = 250\ \mu\text{A}$, Referenced to 25°C		-5		mV/ $^\circ\text{C}$
$R_{DS(on)}$	Static Drain-Source On-Resistance	$V_{GS} = 10\text{ V}$, $I_D = 16\text{ A}$ $V_{GS} = 4.5\text{ V}$, $I_D = 15\text{ A}$ $V_{GS} = 10\text{ V}$, $I_D = 16.5\text{ A}$, $T_J = 125^\circ\text{C}$		6.5 7.5 10	8.5 10.5 13	m Ω
$I_{D(on)}$	On-State Drain Current	$V_{GS} = 10\text{ V}$, $V_{DS} = 5\text{ V}$	50			A
g_{FS}	Forward Transconductance	$V_{DS} = 5\text{ V}$, $I_D = 16\text{ A}$		74		S
Dynamic Characteristics						
C_{iss}	Input Capacitance	$V_{DS} = 15\text{ V}$, $V_{GS} = 0\text{ V}$, $f = 1.0\text{ MHz}$		3087		pF
C_{oss}	Output Capacitance			489		pF
C_{riss}	Reverse Transfer Capacitance			185		pF
Switching Characteristics (Note 2)						
$t_{d(on)}$	Turn-On Delay Time	$V_{DD} = 15\text{ V}$, $I_D = 1\text{ A}$, $V_{GS} = 10\text{ V}$, $R_{GEN} = 6\ \Omega$		10	20	ns
t_r	Turn-On Rise Time			12	22	ns
$t_{d(off)}$	Turn-Off Delay Time			48	77	ns
t_f	Turn-Off Fall Time			10	20	ns
Q_g	Total Gate Charge	$V_{DS} = 15\text{ V}$, $I_D = 16\text{ A}$, $V_{GS} = 5\text{ V}$		25	35	nC
Q_{gs}	Gate-Source Charge			7.5		
Q_{gd}	Gate-Drain Charge			6.5		

Electrical Characteristics (continued) $T_A = 25^\circ\text{C}$ unless otherwise noted

Drain–Source Diode Characteristics and Maximum Ratings

I_S	Maximum Continuous Drain–Source Diode Forward Current			3.2	A
V_{SD}	Drain–Source Diode Forward Voltage	$V_{GS} = 0\text{ V}, I_S = 2.7\text{ A}$ (Note 2)		0.7	1.2
					V

Notes:

- $R_{\theta JA}$ is the sum of the junction-to-case and case-to-ambient thermal resistance where the case thermal reference is defined as the solder mounting surface of the drain pins. $R_{\theta JC}$ is guaranteed by design while $R_{\theta CA}$ is determined by the user's board design.

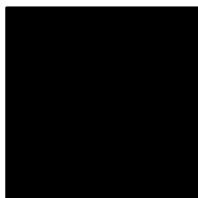

a) $R_{\theta JA} = 40^\circ\text{C/W}$ when mounted on a 1 in^2 pad of 2 oz copper



b) $R_{\theta JA} = 96^\circ\text{C/W}$ when mounted on a minimum pad.

Scale 1 : 1 on letter size paper

- Pulse Test: Pulse Width $< 300\mu\text{s}$, Duty Cycle $< 2.0\%$

- Maximum current is calculated as:
$$\sqrt{\frac{P_D}{R_{DS(ON)}}}$$

where P_D is maximum power dissipation at $T_C = 25^\circ\text{C}$ and $R_{DS(on)}$ is at $T_{J(max)}$ and $V_{GS} = 10\text{V}$. Package current limitation is 21A

Typical Characteristics

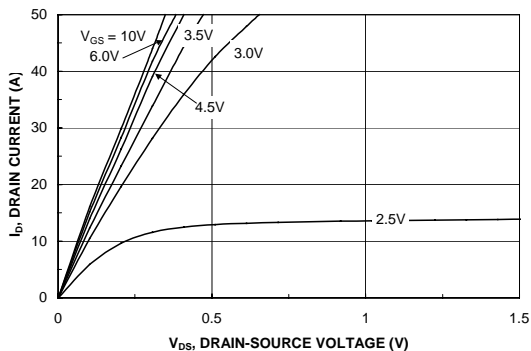

Figure 1. On-Region Characteristics.

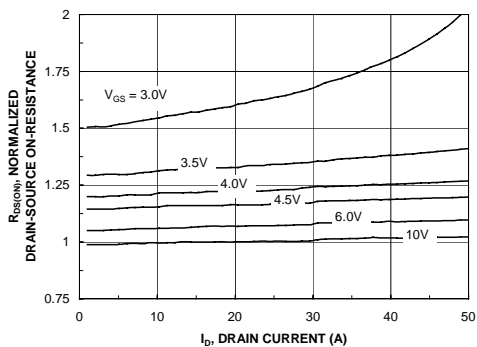

Figure 2. On-Resistance Variation with Drain Current and Gate Voltage.

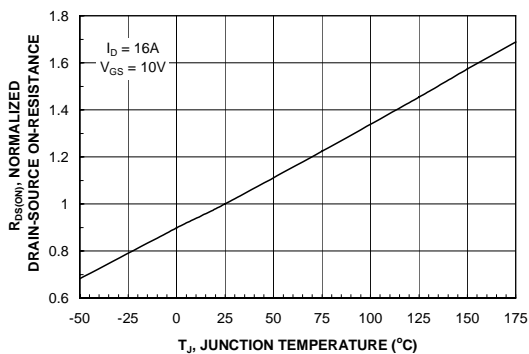

Figure 3. On-Resistance Variation with Temperature.

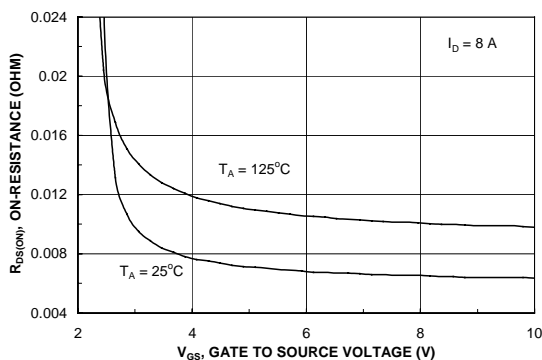

Figure 4. On-Resistance Variation with Gate-to-Source Voltage.

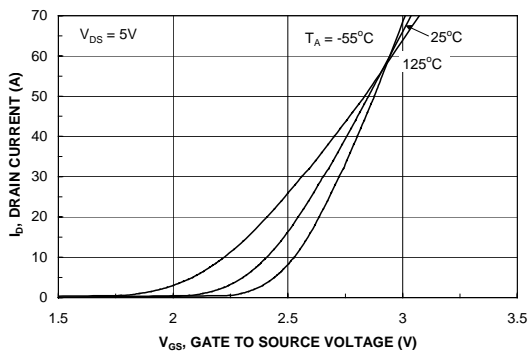

Figure 5. Transfer Characteristics.

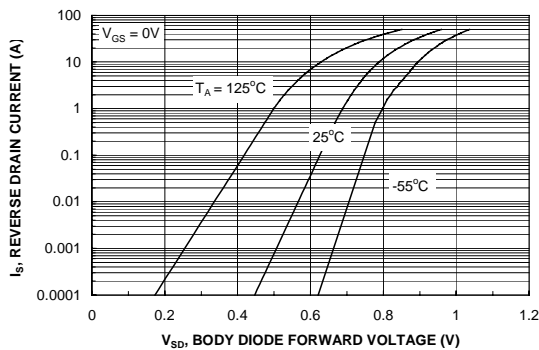

Figure 6. Body Diode Forward Voltage Variation with Source Current and Temperature.

Typical Characteristics

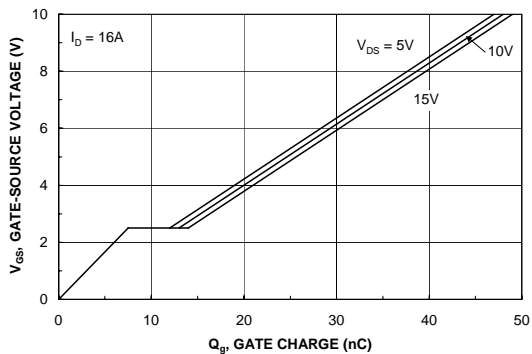

Figure 7. Gate Charge Characteristics.

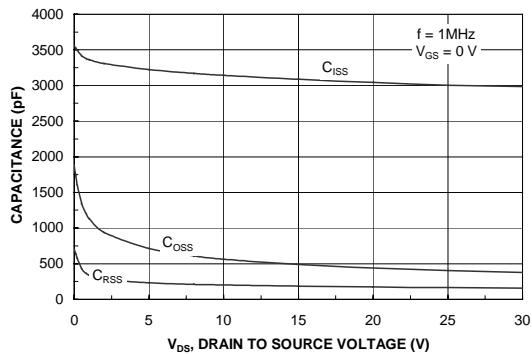

Figure 8. Capacitance Characteristics.

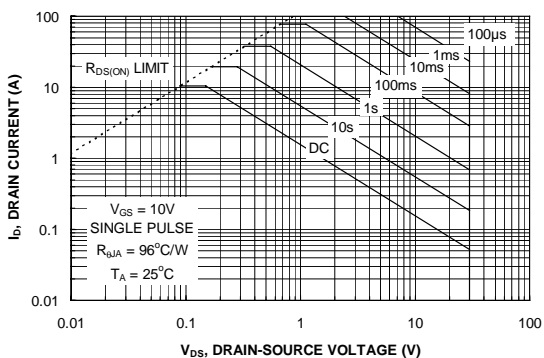

Figure 9. Maximum Safe Operating Area.

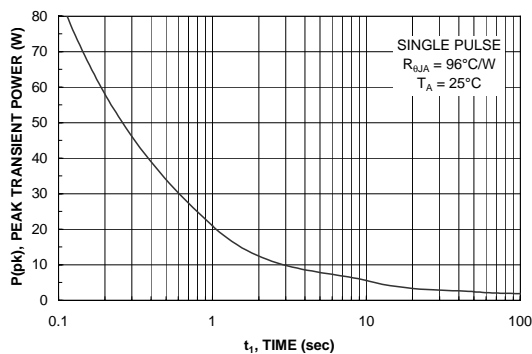

Figure 10. Single Pulse Maximum Power Dissipation.

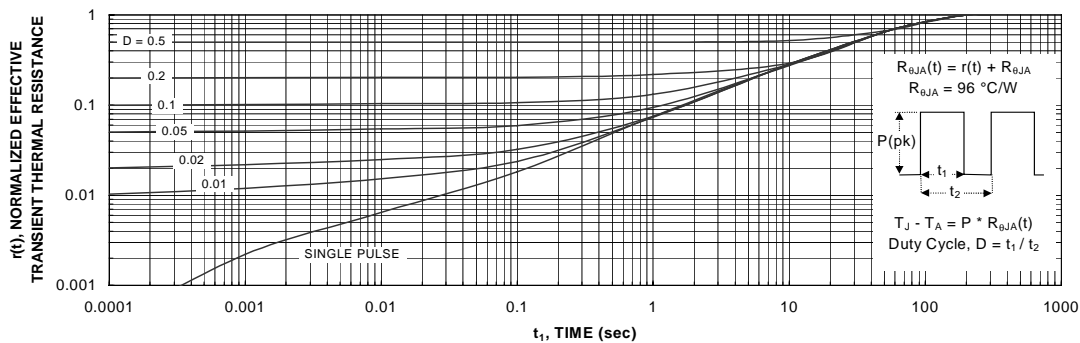

Figure 11. Transient Thermal Response Curve.

Thermal characterization performed using the conditions described in Note 1b
 Transient thermal response will change depending on the circuit board design.

TRADEMARKS

The following are registered and unregistered trademarks Fairchild Semiconductor owns or is authorized to use and is not intended to be an exhaustive list of all such trademarks.

ACE _x TM	FAST [®]	PACMAN TM	SuperSOT TM -3
Bottomless TM	FAST _r TM	POP TM	SuperSOT TM -6
CoolFET TM	GlobalOptoisolator TM	PowerTrench [®]	SuperSOT TM -8
CROSSVOLT TM	GTO TM	QFET TM	SyncFET TM
DenseTrench TM	HiSeC TM	QS TM	TinyLogic TM
DOMET TM	ISOPLANAR TM	QT Optoelectronics TM	UHC TM
EcoSPARK TM	LittleFET TM	Quiet Series TM	UltraFET [®]
E ² CMOS TM	MicroFET TM	SILENT SWITCHER [®]	VCX TM
EnSigna TM	MICROWIRE TM	SMART START TM	
FACT TM	OPTOLOGIC TM	Star* Power TM	
FACT Quiet Series TM	OPTOPLANAR TM	Stealth TM	

DISCLAIMER

FAIRCHILD SEMICONDUCTOR RESERVES THE RIGHT TO MAKE CHANGES WITHOUT FURTHER NOTICE TO ANY PRODUCTS HEREIN TO IMPROVE RELIABILITY, FUNCTION OR DESIGN. FAIRCHILD DOES NOT ASSUME ANY LIABILITY ARISING OUT OF THE APPLICATION OR USE OF ANY PRODUCT OR CIRCUIT DESCRIBED HEREIN; NEITHER DOES IT CONVEY ANY LICENSE UNDER ITS PATENT RIGHTS, NOR THE RIGHTS OF OTHERS.

LIFE SUPPORT POLICY

FAIRCHILD'S PRODUCTS ARE NOT AUTHORIZED FOR USE AS CRITICAL COMPONENTS IN LIFE SUPPORT DEVICES OR SYSTEMS WITHOUT THE EXPRESS WRITTEN APPROVAL OF FAIRCHILD SEMICONDUCTOR CORPORATION. As used herein:

1. Life support devices or systems are devices or systems which, (a) are intended for surgical implant into the body, or (b) support or sustain life, or (c) whose failure to perform when properly used in accordance with instructions for use provided in the labeling, can be reasonably expected to result in significant injury to the user.
2. A critical component is any component of a life support device or system whose failure to perform can be reasonably expected to cause the failure of the life support device or system, or to affect its safety or effectiveness.

PRODUCT STATUS DEFINITIONS

Definition of Terms

Datasheet Identification	Product Status	Definition
Advance Information	Formative or In Design	This datasheet contains the design specifications for product development. Specifications may change in any manner without notice.
Preliminary	First Production	This datasheet contains preliminary data, and supplementary data will be published at a later date. Fairchild Semiconductor reserves the right to make changes at any time without notice in order to improve design.
No Identification Needed	Full Production	This datasheet contains final specifications. Fairchild Semiconductor reserves the right to make changes at any time without notice in order to improve design.
Obsolete	Not In Production	This datasheet contains specifications on a product that has been discontinued by Fairchild semiconductor. The datasheet is printed for reference information only.

Общество с ограниченной ответственностью «МосЧип»
Адрес: 107023, г.Москва, Семеновский переулок, д.6, офис 409

Данный компонент на территории Российской Федерации

Вы можете приобрести в компании MosChip.

Для оперативного оформления запроса Вам необходимо перейти по данной ссылке:

<http://moschip.ru/get-element>

Вы можете разместить у нас заказ для любого Вашего проекта, будь то серийное производство или разработка единичного прибора.

В нашем ассортименте представлены ведущие мировые производители активных и пассивных электронных компонентов.

Распределительные склады, находящиеся в России, Европе и в Китае, позволяют нам оперативно поставить необходимые компоненты в оптимальные для Вас сроки.

На всех этапах разработки и производства наши партнеры могут получить квалифицированную поддержку опытных инженеров.

Система менеджмента качества компании отвечает требованиям ISO 9001:2011

Офис по работе с юридическими лицами:

107023, г.Москва, Семеновский переулок, д.6, Бизнес-центр «АВС»

Телефон: +7 495 668-12-70 (многоканальный)

Факс: +7 495 668-12-70 (доб.304)

E-mail: info@moschip.ru

Skype отдела продаж:

moschip.ru_3	moschip.ru_6
moschip.ru_4	moschip.ru_7
moschip.ru_11	moschip.ru_8
moschip.ru_12	moschip.ru_9