

HIGH POWER 8C-30C SERIES

8kV to 30kV High Voltage Cap-Charging Supplies

This High Power line of high-voltage regulated DC to DC converters is an extension of the C Series, directly addressing the high power density needs of >30 watt applications. High Power 8C - 30C units provide up to 60/125/250 watts. This high power density is especially suited to high-energy systems with large capacitances, fast repetition rates, or high continuous-DC-power requirements. See Application Note 10 for more changing information. Typical applications for the High Power 8C-30C Series include the following: laser, cap-charger, pulse generators, Q-switch, and TDR test equipment.

- 7 models from 0 to 8kV through 0 to 30kV
- 60, 125, or 250 watts of output power
- Maximum Iout capability down to 0 Volts
- Maximum Iout during charge/rise time
- Output short-circuit protection
- Very fast rise with very low overshoot



- High efficiency
- High power to voltage density
- Very low profile
- Output current & voltage monitors
- >200,000 hour MTBF @65°C
- Fixed-frequency, low-stored-energy design
- UL/cUL Recognized Component; CE Mark (LVD & RoHS)

PARAMETER	CONDITIONS	ALL TYPES																				UNITS																
INPUT		ALL TYPES																																				
Voltage Range	Full Power	+ 23 to 30																				VDC																
Voltage Range	Derated Power Range	60W, 125W: + 11 to 30, 250W: 15-30																				VDC																
Current	Standby / Disable	< 40																				mA																
Current	No Load, Max Eout	8C to 15C < 500, 20C to 25C < 600																				mA																
Current	Max Load, Max Eout	60W: 3.25, 125W: 6.5, 250W: 13																				A																
AC Ripple Current	Nominal Input, Full Load	< 50																				mA p-p																
OUTPUT		8C					10C					12C					15C					20C					25C					30C						
Voltage Range	Nominal Input	0 to 8,000					0 to 10,000					0 to 12,000					0 to 15,000					0 to 20,000					0 to 25,000					0 to 30,000					VDC	
Power	Nominal Input, Max Eout	60	125	250	60	125	250	60	125	250	60	125	250	60	125	250	60	125	250	60	125	250	60	125	250	60	125	250	60	125	250	60	125	250	60	125	250	Watts
Current	Iout, Entire Output Voltage Range	7.5	15.5	31.2	6	12.5	25	5	10.5	20.8	4	8.3	16.7	3	6.25	12.5	2.4	5	10	2	4.17	8.33																mA
Current Scale Factor	Full Load	4.7	14.2	6.25	4.1	10.9	5	4.0	7.4	4.17	4.0	7.5	3.33	.65	.653	2.5	.65	.650	2	.65	.642	1.67															mAV	
Voltage Monitor Scaling		60W & 125W Models - 1000:1 ± 2% into 10MΩ; 250W Models - 10,000:1 ± 2%																				-																
Internal Capacitance	Capacitance / 95% Decay (50Meg Load)	4400/659	2200/330	1500/225	2933/439	1467/220	1500/225	2933/439	1467/220	750/112	2200/330	1100/165	750/112	1320/200	880/132	750/112	1100/165	733/110	500/75	825/125	550/85	500/75															pF/mS	
Ripple	Full Load, Max Eout	< 1%																				V p-p																
Rise Time	Max Iout, Various C Loads & Eout	Figure A																				-																
Storage Capacitance	Internal	4400	2200	1500	2933	1467	1500	2933	1467	750	2200	1100	750	1320	880	750	1100	733	500	825	550	500														pF		
Overshoot	C Load, 0 Eout to Full Eout	< 1%																				V pk																
Line Regulation	Nom. Input, Max Eout, Full Power	< 0.01%																				VDC																
Static Load Regulation	No Load to Full Load, Max Eout	< 0.01%																				VDC																
Stability	30 Min. warmup, per 8 hr/ per day	< 0.01% / < 0.02%																				VDC																
PROGRAMMING & CONTROLS		ALL TYPES																																				
Input Impedance	Nominal Input	+ Output Models 1.1MΩ to GND, - Output Models 1.1MΩ to +5 Vref																				MΩ																
Adjust Resistance	Typical Potentiometer Values	10K to 100K (Pot across Vref. & Signal GND, Wiper to Adjust)																				Ω																
Adjust Logic	0 to +5 for +Out, +5 to 0 for - Out	+4.64 VDC for +Output or +0.36 for -Output = Nominal Eout																				-																
Output Voltage & Impedance	T=+25°C	+ 5.00VDC ± 1%, Zout = 464Ω ± 1%																				-																
Enable/Disable		0 to +0.8V Disable, +2.0 to 32 Enable (Default = Enable)																				VDC																
ENVIRONMENTAL		ALL TYPES																																				
Operating	Full Load, Max E out, Case Temperature	-40 to +65																				°C																
Coefficient	Over the Specified Temperature	±50 (±25 Optional)																				PPM/°C																
Thermal Shock	Mil-Std-810, Method 503-4, Proc. II	-40 to +65																				°C																
Storage	Non-Operating, Case Temp.	-55 to +105																				°C																
Humidity	All Conditions, Standard Package	0 to 95% non-condensing																				-																
Altitude	Standard Package, All Conditions	Sea Level through 70,000																				ft																
Shock	Mil-Std-810, Method 516.5, Proc. IV	20																				G's																
Vibration	Mil-Std-810, Method 514.5, Fig.514.5C-3	10																				G's																

Specifications subject to change without notice.

C = uF
V = Volts
I = mA
T = mS

$$T = \frac{C \times V}{I}$$

C = uF
V = kV
I = mA
F = Hz

$$I = C \times V \times F$$

C = uF
V = kV
I = mA
F = Hz

$$F = \frac{I}{C \times V}$$

C = uF
E² = kV
J = Ws

$$J = \frac{C \times E^2}{2}$$

Figure A - Rise Time Formulas

NOTES: Capacitance must include HVPS internal Capacitance.



Making High Voltage Easier!®

Higher Service, Higher Performance, Higher Reliability

©2011, UltraVolt Inc. All rights reserved.

HIGH POWER 8C-30C SERIES

8kV to 30kV High Voltage Cap-Charging Supplies

8C TO 15C - 60/125W



20C TO 30C - 60/125W

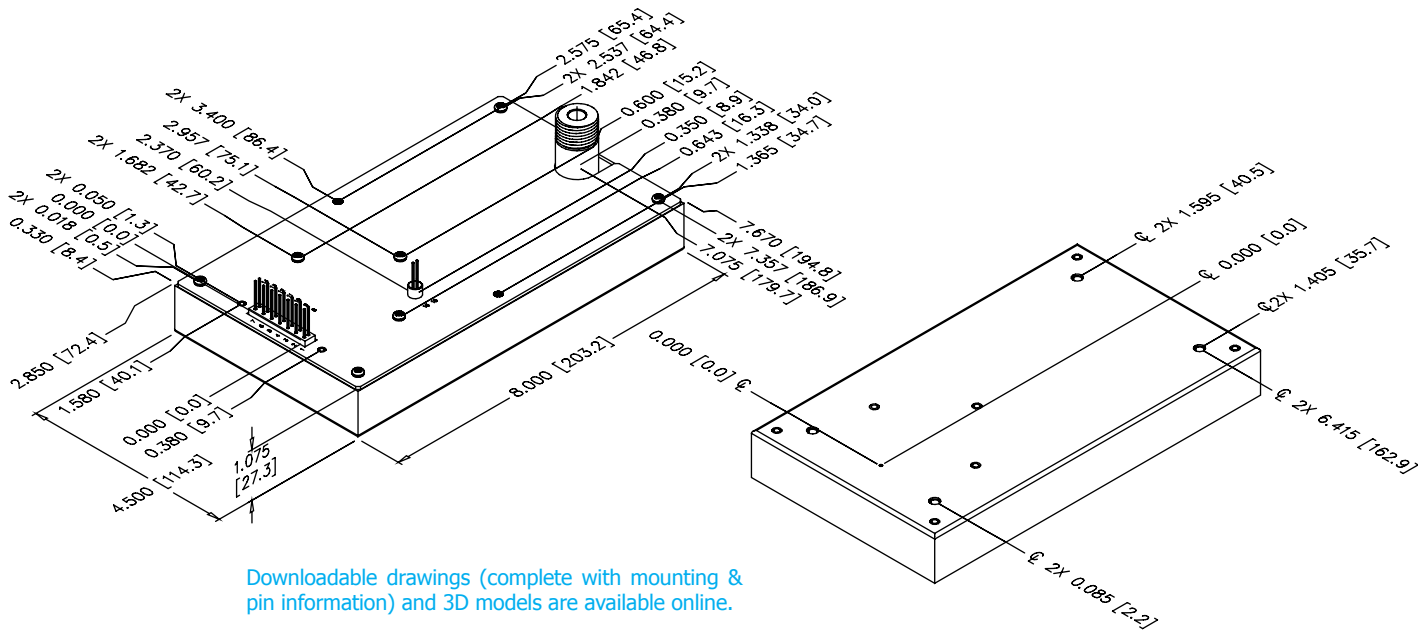

Downloadable drawings (complete with mounting & pin information) and 3D models are available online.



Making High Voltage Easier!®

1800 Ocean Avenue, Ronkonkoma, NY 11779
 Phone: 1-631-471-4444 Fax: 1-631-471-4696 www.ultravolt.com

HIGH POWER 8C-30C SERIES

8kV to 30kV High Voltage Cap-Charging Supplies

8C TO 30C - 250W (PRELIMINARY)

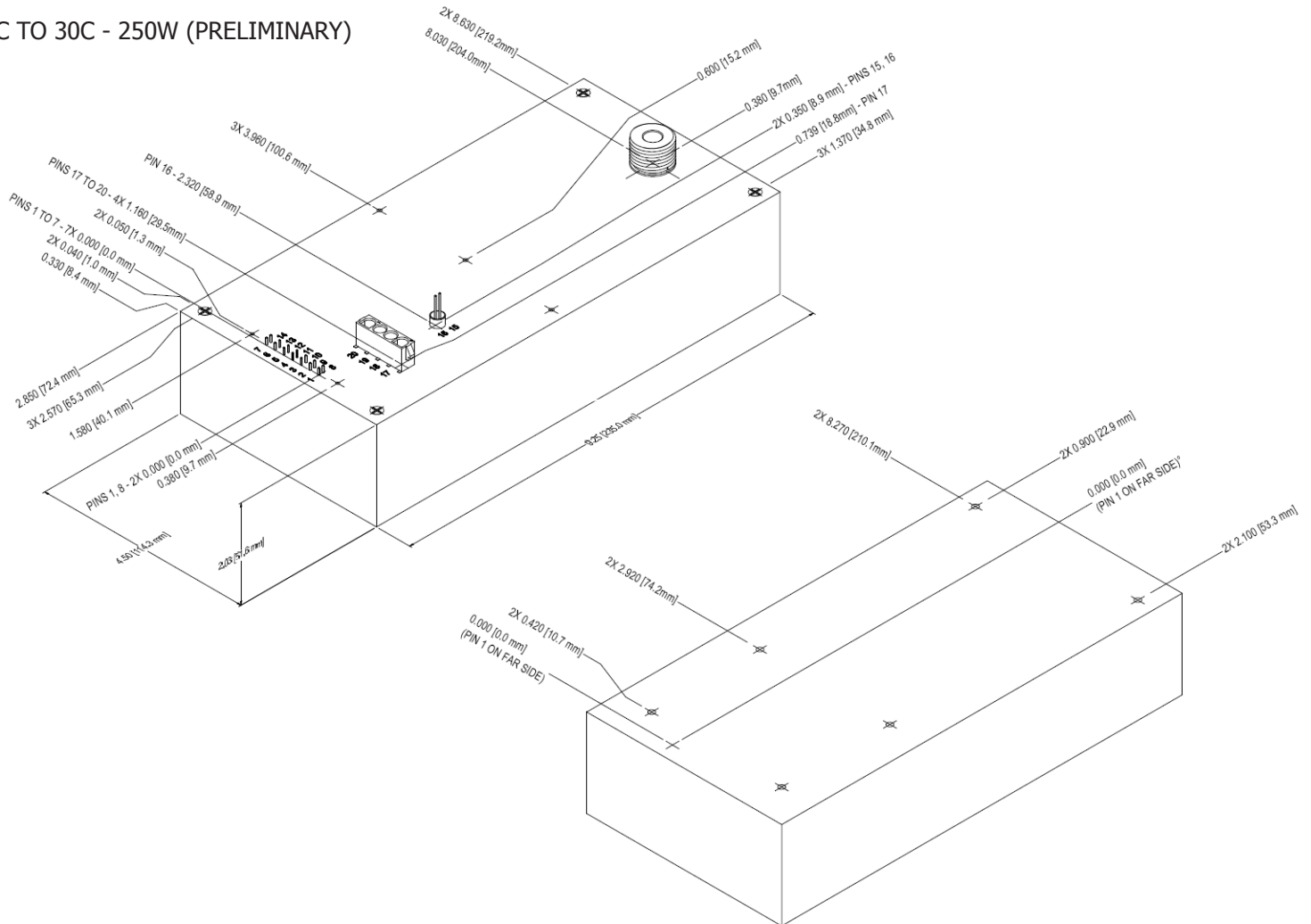

CONSTRUCTION

Epoxy-filled Aluminum Box
Chem film per MIL-A-8625 Type II (Anodizing)

SIZE - 60 & 125W MODELS

Volume 38.7 in³ (634cc)
Weight 2.6 lbs. (1.18kg)

SIZE - 250W MODELS

Volume 84.5 in³ (1386cc)
Weight 5.6 lbs. (2.54kg)

TOLERANCE

Overall $\pm 0.025''$ (0.64)
Pin to Pin $\pm 0.015''$ (0.38)
Hole to hole location $\pm 0.025''$ (0.64)

PINS

Gold-plated 0.025 (0.64) sq.
The center of the pins and mounting holes are located from the center of pin 1
Pins 1 thru 14 spacing 0.100 (2.54) x 0.200 (5.08) on center, height from cover 0.280 (7.11) min
Pins 15 and 16 spacing 0.100 (2.54) on center, height from cover 0.450 (11.43) min

HV OUTPUT CONNECTION

Unit requires an LGH flying lead connector for proper operation:
8C to 15C (60W & 125W Models) = CA-20KV-1000
20C to 30C (60W & 125W Models) = CA-40KV-1000
8C to 30C (250W Models) = CA-40KV-1000



Making High Voltage Easier!®

1800 Ocean Avenue, Ronkonkoma, NY 11779
Phone: 1-631-471-4444 Fax: 1-631-471-4696 www.ultravolt.com

HIGH POWER 8C-30C SERIES

8kV to 30kV High Voltage Cap-Charging Supplies

CONNECTIONS	
PIN	FUNCTION
1 & 8	Input-Power Ground Return
2 & 9	Positive Power Input
3	Iout Monitor
4	Enable/Disable
5	Signal Ground Return
6	Remote Adjust Input
7	+5VDC Reference Output
10	N/C (or Arc Detect option)
11, 12, & 13	N/C
14	Eout Monitor
15 & 16	HV Ground Return

All grounds joined internally. Power-supply mounting points isolated from internal grounds by >100kΩ, .01uF / 500V (Max).

ORDERING INFORMATION		
Type	0 to 8,000 VDC Output	8C
	0 to 10,000 VDC Output	10C
	0 to 12,000 VDC Output	12C
	0 to 15,000 VDC Output	15C
	0 to 20,000 VDC Output	20C
	0 to 25,000 VDC Output	25C
	0 to 30,000 VDC Output	30C
Input	24VDC Nominal	24
Polarity	Positive Output	-P
	Negative Output	-N
Power	60 Watts Output	60
	125 Watts Output	125
	250 Watts Output	250
Heat Sink	.400" High (sized to fit case)	-H
PCB Support	(5) 0.187" standoffs on top cover	-Z11
Enhanced Interface	5V Controls and Monitors	-I5
	10V Control and Monitors	-I10
Options	Arc Detect	-AD
	Arc Quench	-AQ
	25PPM Temperature Coefficient	-25PPM

Note: For more information on the enhanced interface options, download the [I5/I10 Option datasheet](#).

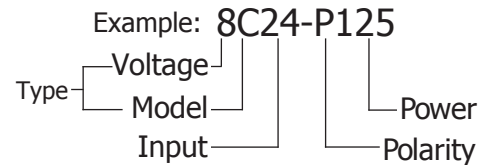

Popular accessories ordered with this product include CONN-KIT-HP, BR-7 and BR-8 mounting bracket kits and our full range of high voltage output connectors (see Accessories & Connectors datasheet).



Non-RoHS compliant units are available. Please contact the factory for more information.

Manufactured in USA



Данный компонент на территории Российской Федерации

Вы можете приобрести в компании MosChip.

Для оперативного оформления запроса Вам необходимо перейти по данной ссылке:

<http://moschip.ru/get-element>

Вы можете разместить у нас заказ для любого Вашего проекта, будь то серийное производство или разработка единичного прибора.

В нашем ассортименте представлены ведущие мировые производители активных и пассивных электронных компонентов.

Нашей специализацией является поставка электронной компонентной базы двойного назначения, продукции таких производителей как XILINX, Intel (ex.ALTERA), Vicor, Microchip, Texas Instruments, Analog Devices, Mini-Circuits, Amphenol, Glenair.

Сотрудничество с глобальными дистрибьюторами электронных компонентов, предоставляет возможность заказывать и получать с международных складов практически любой перечень компонентов в оптимальные для Вас сроки.

На всех этапах разработки и производства наши партнеры могут получить квалифицированную поддержку опытных инженеров.

Система менеджмента качества компании отвечает требованиям в соответствии с ГОСТ Р ИСО 9001, ГОСТ РВ 0015-002 и ЭС РД 009

Офис по работе с юридическими лицами:

105318, г.Москва, ул.Щербаковская д.3, офис 1107, 1118, ДЦ «Щербаковский»

Телефон: +7 495 668-12-70 (многоканальный)

Факс: +7 495 668-12-70 (доб.304)

E-mail: info@moschip.ru

Skype отдела продаж:

moschip.ru

moschip.ru_4

moschip.ru_6

moschip.ru_9