

CONTROL PANEL WITH FONTS, GRAPHICS COMMANDS AND MACROS

Touch Panel
optional



also available in
blue-white



EA KIT160-6LEDTP
Dimension 102 x 80 x 36mm
Viewing area 70 x 36 mm

TECHNICAL DATA

- * LCD GRAPHICS DISPLAY WITH DIVERSE GRAPHICS FUNCTIONS AND FONTS
- * 160x80 PIXELSWITH LED ILLUMINATION
- * BLACK, SNAP-IN HOUSINGWITH ANTI-GLARE SCREEN ORTOUCH PANEL
- * FONT ZOOM FROMapprox. 2.5mm VIAapprox. 5mm TOapprox. 35mm
- * SUPPLY VOLTAGE OF 5V/400mA OR OPTIONALLY 9..35V
- * BLUE-WHITEVERSION120mA/5V ONLY
- * RS-232 OR OPTIONALLY RS-422WITH BAUD RATES OF 1200..115200 BD
- * POSITIONING**ACCURATE TO THE PIXEL** WITH ALL FUNCTIONS
- * PROGRAMMING BY MEANS OF HIGH-LEVEL LANGUAGE-TYPE COMMANDS:
- * STRAIGHT LINE, POINT, AREA, AND/OR/EXOR, BAR GRAPH...
- * UP TO 256 MACROS PROGRAMMABLE
- * COMBINATIONS OF TEXT AND GRAPHICS
- * PULL-DOWN MENUS

ACCESSORIES

- * INTEGRATED TOUCH PANEL WITH 8x4 FIELDS (ANTI-GLARE, SCRATCH-RESISTANT)
- * FLOPPY DISK FOR MACRO PROGRAMMING (PC DOS): **EA DISK240**
- * CABLE (1.5m) FOR CONNECTING TO 9-PIN SUB-D (RS-232 FEMALE): **EA KV24-9B**

ORDER DESIGNATION

160x80 DOT SWITH LED ILLUMINATION GB/GN
160x80 DOT SWITH TOUCH PANEL, LED ILLUMINATION, GB/GN
BLUE-WHITE WITH TOUCH PANEL
SUPPLY VOLTAGE 9..35V INSTEAD OF 5V
RS-422 INSTEAD OF RS-232

EA KIT160-6LED
EA KIT160-6LEDTP
EA KIT160-6LWTP
EA OPT-9/35V
EA OPT-RS4224

GENERAL

The EA KIT160 is a fully assembled control and operating unit with a variety of integrated functions. The display has very compact dimensions and offers excellent super-twist contrast, which means the unit can be put into operation immediately. It is controlled via the standard RS-232 or RS-422 interface. In addition to complete graphics routines for display output, the operating unit also contains a wide variety of fonts. Graphics commands similar to high-level language are used for programming. There is no longer any need for the time-consuming programming of character sets and graphics routines. The ease of use offered by macros and input via touch panel make it a real power display.

HARDWARE

The control panel is designed to work with an operating voltage of +5V. A supply voltage of 9..35V is also possible. Serial asynchronous data transfer is carried out in RS-232 or RS-422 format. The transmission format is set permanently to 8 data bits, 1 stop bit, and no parity. Rates between 1,200 baud and 115,200 baud can be selected using a PC. RTS and CTS handshake lines are available.

Data format:



TOUCH PANEL

The EA KIT160-6 LEDTP version is equipped with an integrated touch panel. You can make entries and menu settings by touching the display. The labeling of the „keys“ is flexible and can also be changed during runtime (different languages, icons). The drawing of the individual „keys“ and the labeling or grouping of several fields is handled by the integrated software.

SOFTWARE

The control panel is programmed by means of commands, such as *Draw a rectangle from (0,0) to (64, 15)*. No additional software or drivers are required. Strings can be placed with **pixel accuracy**. Text and graphics can be combined at any time. Up to 16 different character sets can be used. Each one can be zoomed from 2 to 8 times. When the 8-times zoom is used with the largest character set (16x8), the words and numbers displayed will fill the screen (= 128x64).

SETTING THE CONTRAST

The contrast of the display is set by means of the integrated potentiometer and remains constant across the entire temperature range as a result of the on-board temperature compensation. If required, you can connect an external potentiometer (25 kOhm) at the eyelets (J11). The solder straps LB 6 and LB 7 must be open (see page 4).

ACCESSORIES

Floppy disk for macro creation

A floppy disk (EA DISK240) is required for macro programming^{*)}. This converts the commands entered in a text file into a code that can be read by the operating unit, and programs them into the EEPROM.

Cable for PC

To enable simple connection to PCs (macro programming), we provide a 1.5m cable and a 9-pin SUB-D female connector (EA KV24-9B). Simply insert it into COM 1 or COM 2 and get started. Note: The cable is not suitable for the RS-422 version EA OPT-RS4224.

^{*)} also available at <http://www.lcd-module.de/deu/disk/disk240.zip>

ELECTRONIC ASSEMBLY

EXTERNAL KEYBOARD (EA KIT160-6LED ONLY)

A keyboard (anything from individual keys to an 8x4 matrix keyboard) can be connected at the plug-in connection J4. The connected keys are debounced by means of software. Please note that it is only possible to connect an external keyboard to the EA KIT160-6LED version without an integrated touch panel.

Each key is switched between an output and an input. Each input has a 100kΩ pullup. Up to 8 keys can be connected at each output.

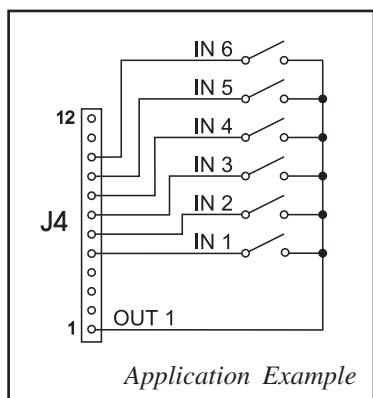

Transmitting the keystrokes

At each keystroke, the associated key number (1..32) is transmitted. The release of the key is not transmitted. If the release of the key is to be transmitted as well, this can be done by defining touch macro no. 0. The automatic keyboard scan can be deactivated by means of the „ESC T A 0“ command.

The key number can be determined as follows: Key number = (output - 1) * 8 + input (**output: a number between 1 and 4, input: between 1 and 8**).

Note: If the handshake line (e.g. CTS) does not permit transmission,

keystrokes can be lost.

Matrix Keypad Connector J4		
Pin	Symbol	Funktion
1	OUT 1	Output Column 1
2	OUT 2	Output Column 2
3	OUT 3	Output Column 3
4	OUT 4	Output Column 4
5	IN 1	Input line 1
6	IN 2	Input line 2
7	IN 3	Input line 3
8	IN 4	Input line 4
9	IN 5	Input line 5
10	IN 6	Input line 6
11	IN 7	Input line 7
12	IN 8	Input line 8

TOUCH PANEL (EA KIT160-6LEDTP ONLY)

The EA KIT160-6LEDTP version is equipped with an integrated touch panel with 32 fields. The ontpol panel offers convenient commands supporting this touch panel. It is possible, for example, to group a number of touch fields to form a single large key and then draw and label the key. You can also assign a return code (1..255) to the key you have defined. If a return code of 0 is assigned, the key is disabled and has no effect when pressed.

When the touch keys are touched, they can be automatically inverted and a tone can sound, indicating they have been touched. At the same time, the defined return code of the key is transmitted via the serial interface, or an internal touch macro with the number of the return code is started.

Example:

Definition of a key from field 11 to 21 with the return code 65= 'A' and the text „STOP“. Note: Before individual keys are defined, all fields should be disabled by means of „ESC T R“.

1	2	3	4	5	6	7	8
9	10	11	12	13	14	15	16
17	18	19	20	21	22	23	24
25	26	27	28	29	30	31	32

Exampel	Transmitted codes											Remarks	
for Compiler	#* 11, 21, 'A', 2, "STOP"											Number of texts will be not noted here ! Point '.' stands for not displayable ASCII-characters	
ASCII	ESC	*	.	.	A	.	.	S	T	O	P		.
Hex	\$1B	\$2A	\$0B	\$15	\$41	\$02	\$01	\$53	\$54	\$4F	\$50		\$00
Decimal	27	42	11	21	65	2	1	83	84	79	80		0
	Command for Touch	Touch field top left corner	Touch field top right corner	Touch field bottom left corner	Touch field bottom right corner	Return Code	Draw Frame	1-line-text				Text terminator	



SUPPLY 5V / (9-35V)

In the standard model, the supply voltage of +5V is fed in via screw-type terminal J1. Alternatively, the 5V can also be fed in at the 10-pin connector J3 (pin 1: 5V; pin 10: 0V) for the RS-232 interface.

In the case of the version for 9V to 35V (EA OPT-9/35V), the power is supplied via J2.

Important: It is imperative that the polarity is correct. Even very brief polarity reversal can damage the display immediately and irreparably.

RS-232/RS-422 CONNECTION

The operating unit is shipped with an RS-232 interface as standard. The pin assignment of connector J3 is then as shown in the table on the left. J3 has a grid of 2.54mm. If the operating unit is ordered together with the EA OPT-RS4224 option, special RS-422 drivers are fitted. The pin assignment in the table on the right then applies.

RS-232C connector J3			
Pin	Symb	In/Out	Function
1	VDD	-	+ 5V Supply
2	DCD	-	Via LB 4 to DTR
3	DSR	-	Via LB 3 to DTR
4	TxD	Out	Transmit Data
5	CTS	In	Clear To Send
6	RxD	In	Receive Data
7	RTS	Out	Request To Send
8	DTR	-	See Pin 2, Pin 3
9	NC	-	Not Connected
10	GND	-	0V Ground

Incidentally, the same serial data with 5V levels and TTL logic is available at the J5 eyelet strip. These levels are suitable for direct connection to a μ C. If these signals are used, the solder straps LB 10 and LB 11 must be opened (or the four RS422 75176 drivers removed)!

RS-422 Connector J3		
Pin	Symbol	Function
1	VDD	+5V, Supply
2	Data In -	Receive Data
3	Data In +	Receive Data
4	Data Out -	Transmit Data
5	Data Out +	Transmit Data
6	HS In -	Handshake
7	HS In +	Handshake
8	HS Out -	Handshake
9	HS Out +	Handshake
10	GND	0V, Ground

BAUD RATES

The baud rate is set in the factory to 9600. You can use the program KITBAUD.EXE (available on EA DISK240*) to configure it. To do this, you have to connect the KIT160 to COM1 or COM2 and pass the new baud rate as a parameter (e.g. KITBAUD 19200). The following baud rates can be set: 1200, 2400, 4800, 9600, 19200, 38400, 57600 and 115200.

Note: solder bridge WP must be open to change baudrate (see page 6 "WRITE PROTECTION"). Please note that the internal data buffer is only 45 bytes. The RTS handshake line must therefore be queried (+10V level: data can be accepted; -10V level: display is busy). The data format is set permanently to 8 data bits, 1 stop bit, no parity.

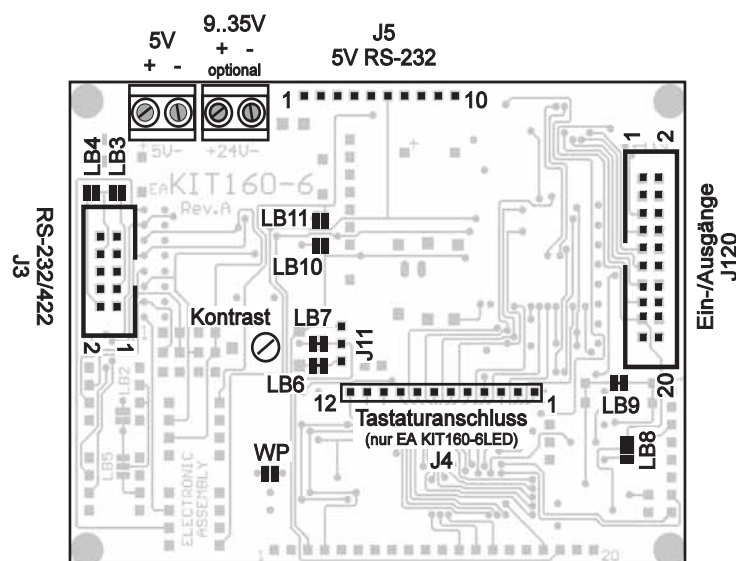

J5 add-on			
Pin	Symbol	In/Out	Function
1	VU	-	9..35V supply
2	VDD	-	+ 5V supply
3	GND	-	0V, ground
4	TxD5	Out	Transmit data (5V)
5	RxD	In	Receive data (5V)
6	RTS	Out	Request to send (5V)
7	CTS	In	Clear to send (5V)
8	RESET	In	H: reset
9	NC	-	not connected
10	NC	-	not connected



*) also available at <http://www.lcd-module.de/disk/disk240.zip>

ELECTRONIC ASSEMBLY

INPUTS AND OUTPUTS

The EA KIT160 is supplied with 8 digital inputs and 8 outputs (5V CMOS level, non-isolated). The connection is made at the 20-pin connector J120.

8 outputs: Each line can be controlled by means of the „ESC Y W“ command. The maximum current per line is 6mA. Output 8 (PIN 17) is used to switch the LED backlighting (ESC Y L n1). If this output is required, the LED backlighting can be separated from the output via the solder strap LB 8 and switched on permanently.

8 inputs: The inputs can be queried and evaluated („ESC Y R“) directly via the serial interface. Each change of logic level (0V or 5V) at the inputs can start an internal port macro. When the 8 lines are combined, 256 port macros can be addressed. Each of these port macros can change the contents of the screen or switch an output. This allows a wide range of control tasks to be carried out. To create the port macros, you need a PC and the floppy disk EA DISK240. You will find a more detailed description of this on page 6. Automatic poll querying can be disabled by means of the „ESC Y A 0“ command.

Digital In- and Outputs J120					
Pin	Symbol	Function	Pin	Symbol	Function
1	VDD	+5V Supply	2	GND	0V, Ground
3	OUT 1	Output 1	4	IN 1	Input 1
5	OUT 2	Output 2	6	IN 2	Input 2
7	OUT 3	Output 3	8	IN 3	Input 3
9	OUT 4	Output 4	10	IN 4	Input 4
11	OUT 5	Output 5	12	IN 5	Input 5
13	OUT 6	Output 6	14	IN 6	Input 6
15	OUT 7	Output 7	16	IN 7	Input 7
17	OUT 8	Output 8	18	IN 8	Input 8
19	GND	0V, Ground	20	VDD	+5V Supply

Note: The logic circuitry is designed for slow operations; in other words, more than 3 changes per second cannot be easily executed. If an input is open, this is evaluated as high (approx. 100 kOhm pullup).

Application examples:

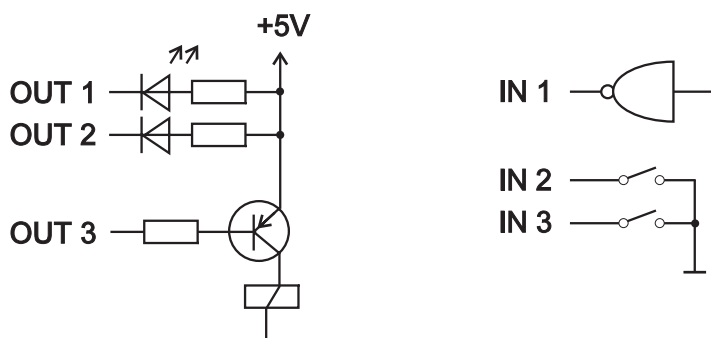

DEFAULT SETTINGS

After power-on or a manual reset, the registers shown here are set to a specific value.

Please note that all the settings can be overwritten by creating a power-on macro (normal macro no. 0).

Default settings		
Register	Command	After power-on/reset
Text mode	ESC L	Set, black
Terminal font	ESC FT	Font 3, no zoom
Cursor	ESC QC	On
Flashing time	ESC QZ	0.6 secs
User-defined characters	ESC E	Undefined
Graphics mode	ESC V	Set
Graphics font	ESC F	Font 3, no zoom
Last xy	ESC W	(0:0)
Bar graph 1..16	ESC B	Undefined
Clipboard	ESC C	Empty
Select/deselect	ESC K	Selected
Outputs OUT1..8	ESC Y	High level/open

MACRO PROGRAMMING

Single or multiple command sequences can be grouped together in macros and stored in the EEPROM. You can then start them by using the *Run macro* commands. There are 3 different types of macros:

Touch macros (1..255)

These are started when you touch a touch field (in versions with a touch panel - TP) or when you operate an external key/matrix keyboard. Touch macro no. 0 is different: It is started when you release a key.

Port macros (0..255)

These are started when voltage is applied to IN 1..8 (only in versions with EA OPT-OPTO8I8O inputs and outputs).

Normal macros (1..255)

These are started by means of a command via the serial interface or from another macro. A series of macros occurring one after the other can be called cyclically (movie, hourglass, multi-page help text).

Power-on macro

Normal macro no. 0 is different: It is executed automatically after power-on. It allows you to switch off the cursor and define an opening screen, for example. To prevent execution of power-on macro, after faulty programming the EEPROM for example, connect RTS line (J5 , pin 6) to GND.

STORING 256 IMAGES IN THE EEPROM

To reduce the transmission times of the serial interface or to save storage space in the processor system, up to 256 images can be stored in the internal EEPROM. They can be called using the "ESC U E" command via the serial interface or from within a touch/port/normal macro. All the images can be used in the Windows BMP format. They can be created and edit using widely available software such as Windows Paint or Photoshop (must be monochrome and correct size).

CREATING INDIVIDUAL MACROS

To create your own macros, you need the following:

- The EA DISK240^{*)} floppy disk, which contains a compiler, examples and fonts
- A PC with a COM1 or COM2 serial interface and approximately 500KB hard disk space
- A text editor such as WordPad or Norton Editor

To define a sequence of commands as a macro, all the commands are written to a file on the PC (e.g. DEMO.KMC). You specify which character sets are to be integrated and which command sequences are to be in which macros.

Once the macros are defined, you start the program C:>KITCOMP DEMO.KMC. This creates an EEPROM file called DEMO.EEP, which is then automatically stored in the display EEPROM with the baud rate entered. This only takes a few seconds, and you can then use your user-defined macros immediately. You will find a detailed description of how to program macros, together with a large number of examples, in the files DOKU.DOC (for WORD) and DOKU.TXT (DOS) on the EA DISK240^{*)} floppy disk.

WRITE PROTECTION FOR MACROS

To prevent overwriting stored macros and images close solder bridge WP (connection VDD-WP). Please note that baudrate is locked, too. So changing the baudrate by KITBAUD.EXE requires an open solder strap WP.

```
; Makro Demo
COM2: 115200 ; KIT ist an COM2 angeschlossen,
        ; Übertragung mit 115.200 Baud
;-----
;Konstanten definieren
AUS = 0
EIN = 1
FONT4x6 = 1
FONT5x6 = 2
FONT6x8 = 3
FONT8x8 = 4
FONT8x16 = 5
;-----
;Fonts einbinden
Font: FONT4x6, 32,95 INTERN4x6
Font: FONT5x6, 32,158 INTERN5x6
Font: FONT6x8, 32,158 INTERN6x8
Font: FONT8x8, 32,158 INTERN8x8
Font: FONT8x16, 32,158 INTERN8x16
;-----
Makro: 0          ; Power-On/Reset Makro
#QC EIN          ; Cursor sichtbar
#FT FONT8x16     ; Terminalfont einstellen
#UL 0,20,<EA2.BMP>; ELECTRONIC ASSEMBLY Logo
```

^{*)} also available at <http://www.lcd-module.de/deu/disk/disk240.zip>

ELECTRONIC ASSEMBLY

INTEGRATED FONTS

5 character sets are integrated in each graphics unit as standard. Each character set can be used at its normal height or at up to 8 times this height. Independently of the height, the width can also be increased two to eight times.

Font 1: 4x6

+ Lower Upper	\$0 (0)	\$1 (1)	\$2 (2)	\$3 (3)	\$4 (4)	\$5 (5)	\$6 (6)	\$7 (7)	\$8 (8)	\$9 (9)	\$A (10)	\$B (11)	\$C (12)	\$D (13)	\$E (14)	\$F (15)
\$20 (dez: 32)		!	"	#	\$	%	&	'	()	*	+	,	-	.	/
\$30 (dez: 48)	0	1	2	3	4	5	6	7	8	9	:	;	<	=	>	?
\$40 (dez: 64)	@	A	B	C	D	E	F	G	H	I	J	K	L	M	N	O
\$50 (dez: 80)	P	Q	R	S	T	U	V	W	X	Y	Z	[\]	^	_

+ Lower Upper	\$0 (0)	\$1 (1)	\$2 (2)	\$3 (3)	\$4 (4)	\$5 (5)	\$6 (6)	\$7 (7)	\$8 (8)	\$9 (9)	\$A (10)	\$B (11)	\$C (12)	\$D (13)	\$E (14)	\$F (15)
\$20 (dez: 32)		!	"	#	\$	%	&	'	()	*	+	,	-	.	/
\$30 (dez: 48)	0	1	2	3	4	5	6	7	8	9	:	;	<	=	>	?
\$40 (dez: 64)	@	A	B	C	D	E	F	G	H	I	J	K	L	M	N	O
\$50 (dez: 80)	P	Q	R	S	T	U	V	W	X	Y	Z	[\]	^	_
\$60 (dez: 96)	^	a	b	c	d	e	f	g	h	i	j	k	l	m	n	o
\$70 (dez: 112)	p	q	r	s	t	u	v	w	x	y	z	{		}	~	
\$80 (dez: 128)										¡	¢	£	¤	¥	¦	§
\$90 (dez: 144)	¨	©	ª	«	¬	­	®	¯	°	±	²	³	´	µ	¶	·

Font 3: 6x8

Each text can be output left justified, right justified or centered. 90° rotation (for vertical installation of the display) is also possible.

Macro programming permits the inclusion of up to 11 additional fonts and the complete redesign of the individual characters. A font editor on the EA DISKFONT6963 floppy disk allows you to create and program in any font you like with a size of up to 16x16 pixels.

Font 5: 8x16

+ Lower Upper	\$0 (0)	\$1 (1)	\$2 (2)	\$3 (3)	\$4 (4)	\$5 (5)	\$6 (6)	\$7 (7)	\$8 (8)	\$9 (9)	\$A (10)	\$B (11)	\$C (12)	\$D (13)	\$E (14)	\$F (15)
\$20 (dez: 32)		!	"	#	\$	%	&	'	()	*	+	,	-	.	/
\$30 (dez: 48)	0	1	2	3	4	5	6	7	8	9	:	;	<	=	>	?
\$40 (dez: 64)	@	A	B	C	D	E	F	G	H	I	J	K	L	M	N	O
\$50 (dez: 80)	P	Q	R	S	T	U	V	W	X	Y	Z	[\]	^	_
\$60 (dez: 96)	^	a	b	c	d	e	f	g	h	i	j	k	l	m	n	o
\$70 (dez: 112)	p	q	r	s	t	u	v	w	x	y	z	{		}	~	
\$80 (dez: 128)										¡	¢	£	¤	¥	¦	§
\$90 (dez: 144)	¨	©	ª	«	¬	­	®	¯	°	±	²	³	´	µ	¶	·

TIP: FONT EFFECTS

With large fonts, you can use the command ESC L TEXT mode (link, pattern) to produce interesting effects through overlaying (writing and offsetting a word several times).

TEST

Original font 8x16 with ZOOM 3 at position 0,0 with black pattern

TEST

"Outline font" produced by overlaying (EXOR) at pos. 1,1

TEST

Overlaying (EXOR) of the "outline font" at pos. 2,2. results in an "outline font with fill"

TEST

Overlaying (OR) with 50% gray pattern of the "outline font" at pos. 0,0. results in a "font with pattern fill"

ALL COMMANDS AT A GLANCE

Command table for the EA KIT160							
Command	Codes				Note		
Commands for terminal operation							
Form feed FF (dec:12)	^L					Deletes the screen and sets the cursor at position (1,1)	
Carriage return CR(13)	^M					Positions the cursor on the left at the beginning of the line	
Line feed LF (dec:10)	^J					Positions the cursor in the line below the current one. If the cursor is in the last line, positions it in the 1st line	
Cursor on/off	ESC	Q	C	n1		n1=0: cursor is not visible; n1=1: cursor flashes (inverse 6/10s)	
Position cursor	ESC	O	n1	n2		n1=column; n2=line; upper left origin is (1,1)	
Set terminal font	ESC	F	T	n1		n1=1: sets font no. n1 (1..16) for terminal operation	
Text output commands							
Text mode	ESC	L	n1	pat		Mode n1: 1=set; 2=delete; 3=inverse 4=replace; 5=inverse replace; pat: pattern no. 0..7	
Set font	ESC	F	n1	n2	n3	Sets font with the number n1 (1..16); n2=X- n3=Y-zoom factor (1x..8x)	
Output string horizontally	ESC	Z	L	x1	y1	Text ... NUL	
Output string rotated by 90° (vertically)			O				
			M				
Define character	ESC	E	n1		data ...	n1=character no.; data=number of bytes depending on current font	
Drawing commands							
Graphics mode	ESC	V	n1			Sets the drawing mode for the commands 'Set point', 'Draw straight line', 'Rectangle', 'Rounded rectangle' and 'Fill area with pattern' n1: 1=set; 2=delete; 3=inverse; 4=replace; 5=inverse replace	
Set point	ESC	P	x1	y1		Sets a pixel at position x1, y1	
Draw straight line	ESC	G	x1	y1	x2 y2	Draws a straight line from x1,y1 to x2,y2	
Continue straight line	ESC	W	x1	y1		Draws a straight line from the last end point to x1, y1	
Rectangle commands							
Draw rectangle	ESC	R	R	x1	y1	x2 y2	Draws a rectangle (frame) from x1,y1 to x2,y2
Draw rounded rectangle			N	x1	y1	x2 y2	Draws a rectangle with rounded corners from x1,y1 to x2,y2
Delete area			L	x1	y1	x2 y2	Deletes an area from x1,y1 to x2,y2 (all pixels off)
Invert area			I	x1	y1	x2 y2	Inverts an area from x1,y1 to x2,y2 (inverts all pixels)
Fill area			S	x1	y1	x2 y2	Fills an area from x1,y1 to x2,y2 (all pixels on)
Fill area with pattern			M	x1	y1	x2 y2 pat	Fills an area from x1,y1 to x2,y2 with the pattern pat (0..7)
Draw box			O	x1	y1	x2 y2 pat	Draws a rectangle with the fill pattern pat (0..7); (always replace)
Draw rounded box			J	x1	y1	x2 y2 pat	Draws a rectangle with the fill pattern mst (0..7); (always replace)
Bitmap image commands							
Image from EEPROM	ESC	U	E	x1	y1	no	Loads an internal image with the number (0..255) from the EEPROM to x1,y1
Load image			L	x1	y1	data ...	Loads an image to x1,y1; see image structure for the data of the image
Send hard copy			H	x1	y1	x2 y2	Requests an image. Sends the width and height in pixels followed by the actual image data via RS232
Display commands (which apply to the whole display)							
Delete display	ESC	D	L				Deletes the contents of the display (all pixels off)
Invert display			I				Inverts the contents of the display (inverts all pixels)
Fill display			S				Fills the contents of the display (all pixels on)
Switch display off			A				Makes the contents of the display invisible, but they remain there and further commands are possible
Switch display on			E				Makes the contents of the display visible again
Reset display			R				Resets and re-initializes the display controller
Macro commands							
Execute macro	ESC	M	N	n1			Calls the (normal) macro with the number n1 (max. 7 levels)
Execute touch macro			T	n1			Calls the touch macro with the number n1 (max. 7 levels)
Execute port macro			P	n1			Calls the port macro with the number n1 (max. 7 levels)
Macros autom. cyclical			A	n1	n2	n3	Processes macros n1..n2 automatically cyclically; n3=pause in 1/10s
Macros autom. ping-pong			J	n1	n2	n3	Processes macros n1..n2..n1 automatically (ping-pong); n3=pause in 1/10s

Bar graph commands													
Define bar graph	ESC	B	R	no	x1	y1	x2	y2	sv	ev	pat	Defines a bar graph to the left (L), right (R), top (O) or bottom (U) with the number no (1..16). x1,y1,x2,y2 define the rectangle enclosing the bar graph. sv,ev are the values for 0% and 100%. pat=pattern (0..7)	
Draw bar graph			no	value								Sets the bar graph with the number no (1..16) to the new user 'value'	
Keyboard/touch panel commands													
Define touch key with horizontal label	ESC	T	H	f1	f2	Ret code	Form	Text ...	NUL	Groups touch fields f1 to f2 (diametrically opposite corner fields) together to form a touch key with the return value 'Ret. code' (=1..255) (Ret. code=0 means the touch key is inactive). 'Form': Draws touch key (=0 nothing; =1 delete; =2 with frame) 'Text': Positions a string on the touch key (centered) using the current font; lines are separated by the character ' ' (\$7C, dec: 124); NUL character (\$00) = end of string			
Define touch key with vertical label (rotated by 90°)			V										
(P)reset touch keys			P	Activates all touch keys in ascending order (fields with code 1..60)									
			R	Deactivates all touch keys (all fields with code 0)									
Touch key response			I	n1	n1=0: Touch key is not inverted when touched n1=1: Touch key is automatically inverted when touched								
			S	n1	n1=0: No tone sounds when (touch) key is touched n1=1: Tone sounds briefly when (touch) key is touched								
Invert touch key			M	n1	The touch key assigned the return code n1 is inverted manually								
Query key manually			W	Sends the currently depressed (touch) key at the RS-232/RS-422 interface									
Key query on/off			A	n1	The keyboard query is n1=0:deactivated; n1=1:activated, keystrokes are sent automatically; n1=2:activated, keystrokes are not sent (query with ESC T W)								
Menu/pop-up commands													
Define menu with horizontal items	ESC	N	H	x1	y1	no	Text ...	NUL	Draws a menu from the corner x1,y1 (horizontal menu = upper left corner; vertical menu = upper right corner) using the current font. no=: currently inverted item (e.g.: 1 = 1st item) Text=: string with the menu items. The items are separated by the character ' ' (\$7C,dec:124), e.g. "Item1 Item2 Item3" The background of the menu is automatically saved to the clipboard. If a menu is already defined, it is automatically canceled and removed				
Define menu with vertical items (rotated by 90°)			V										
Invert menu box			I	Inverts the entire menu box. Useful for negative display									
Next item			N	Inverts the next item or remains at the end									
Previous item			P	Inverts the previous item or remains at the beginning									
Menu end/send			S	Removes the menu from the display and replaces it with the clipboard contents. The current item is sent as a number (1..n) (0=no menu displayed)									
Menu end/macro			M	no	Removes the menu from the display and replaces it with the contents of the clipboard. Macro 'no' is called for item 1; macro no+1 for item 2, and so on								
Menu end/cancel			A	Removes the menu from the display and replaces it with the contents of the clipboard									
Control/definition commands													
Automatic flashing area (cursor function)	ESC	Q	D	x1	y1	x2	y2	Defines a flashing area from x1,y1 to x2,y2; activates the flashing function					
			Z	n1	Sets the flashing time n1= 1..15 in 1/10s; 0=deactivates the flashing function								
			C	n1	Automatically flashing area as cursor for terminal operation n1=0: deactivates flashing function; n1=1: activates flashing function (inverse, 6/10s)								
Select/deselect	ESC	K	S	add	Activates the kit with the address n1 (n1=255: all)								
			D	add	Deactivates the kit with the address n1 (n1=255: all)								
			A	add	Assigns a new address (add) (in the power-on macro, for example)								
Wait (pause)	ESC	X	n1	Wait n1 tenths of a second before the next command is executed									
Buzzer on/off	ESC	J	n1	n1=0:tone off; n1=1:tone on; n1=2..255:for n1 1/10s long on									
Send bytes	ESC	S	num	data ... Sends num (1..255; 0=256) bytes at the RS-232/RS-422 interface; data ... = num bytes (e.g. control of an external serial printer)									
Port commands													
Write output port	ESC	Y	W	n1	n2	n1=0: Sets all 8 output ports in accordance with n2 (=8-bit binary value) n1=1..8: Resets (n2=0), sets (n2=1) or inverts (n2=2) output port n1							
Read input port			R	n1	n1=0: Reads in all 8 input ports as 8-bit binary value n1=1..8: Reads in input port <n1> (1=high level=5V, 0=low level=0V)								
Port scan on/off			A	n1	Deactivates (n1=0) or activates (n1=1) automatic scanning of the input port								
Input port inverse			I	n1	Evaluates the input port (n1=0: normal; n1=1: inverted)								
LED backlit on/off			L	n1	LED backlit n1=0: off, n1=1: on; n1=2: invert; n1=3..255 n1/10 sec. on								

PARAMETERS

The graphics kit can be programmed by means of various integrated commands. Each command begins with ESC followed by one or two command letters and then parameters. All the commands and their parameters, such as coordinates and other transfer values, are always expected as bytes. No separating characters, such as spaces or commas, must be used between them. The commands require **no final byte** such as a carriage return (except for the string \$00).

A..Z, L/R/O/U All commands are transferred as ASCII characters.
Example: G= 71 (dec.) = \$47 initiates the straight-line command.

x1, x2, y1, y2 Coordinates are transferred with 1 byte.
Example: x1= 10 (dec.) = \$0A

ESC 1 byte: 27(dec.) = \$1B

n1,n2,no,sv,ev,value,pat,ret, frm,data Numerical values are transferred with 1 byte.
Example: n1=15(dec.) = \$0F

PROGRAMMING EXAMPLE

The following table shows an example in which the string "Test" is output left justified at coordinate 7,3.

Example	Codes to be output									
	ESC	Z	L	BEL	ETX	T	e	s	t	NUL
In ASCII										
In hex	\$1B	\$5A	\$4C	\$07	\$03	\$54	\$65	\$73	\$74	\$00
In decimal	27	90	76	7	3	84	101	115	116	0
For Turbo Pascal	write(aux, chr(27), 'Z', 'L', chr(7), chr(3), 'Test', chr(0));									
For C	fprintf(stdaux, "\x1BZL%c%c%s\x00", 7, 3, "Test");									
For Q Basic	OPEN "COM1:9600,N,8,1,BIN" FOR RANDOM AS #1 PRINT #1,CHR\$(27)+"ZL"+CHR\$(7)+CHR\$(3)+"Test"+CHR\$(0)									

PATTERN

A pattern type (pat = 0..7) can be set as a parameter with some commands. In this way, rectangular areas, bar graphs and even texts can be linked to different patterns and displayed.

The following fill patterns are available:

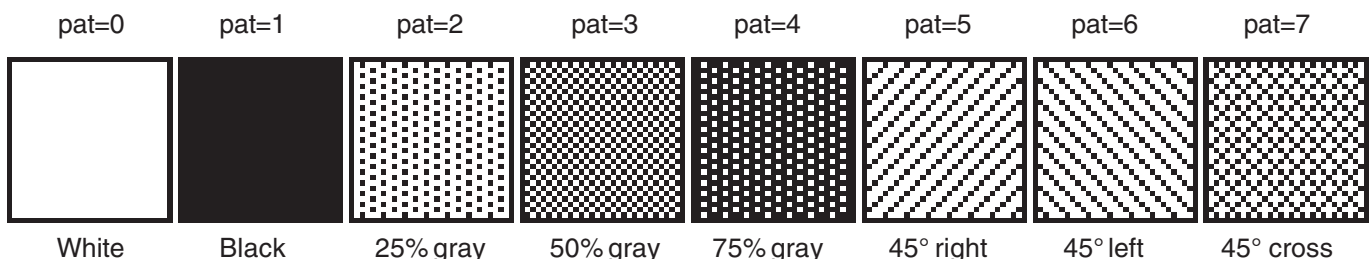

ELECTRONIC ASSEMBLY**DESCRIPTIONS OF THE VARIOUS GRAPHICS FUNCTIONS**

On the following pages you will find detailed descriptions of all of the functions in alphabetical order. In each case, an enlarged section of the image, 50x32 pixels in size, is shown as a hard copy example, indicating the contents of the display after the command is executed. The bytes to be transferred are shown as hex values in the examples.

ESC B L/R/O/U no x1 y1 x2 y2 sv ev pat Define bar graph

Up to 16 bar graphs (**no**=1..16) can be defined. These can extend to the left (**L**), right (**R**), up (**O**) or down (**U**). At its full extent, the bar graph occupies an area from **x1,y1** to **x2,y2**. It is scaled with the start value (no extension) **sv** (=0..254) and the end value (full extension) **ev** (=0..254). The bar graph is always drawn in inverse mode with the pattern (**pat**): The background is thus always retained. (Note: When this command is executed, it defines the bar graph but does not display it).

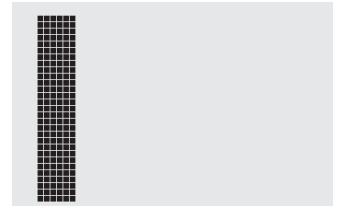

Example: \$1B \$42 \$4F \$01 \$04 \$02 \$09 \$1E \$04 \$14 \$01

Bar graph no. 1, which extends upwards, is defined. When it is fully extended, it takes up an area from 4,2 to 9,30. The start and end values correspond to a 4..20 mA display. (The diagram shows the bar graph fully extended, as represented with \$42 \$01 \$14.)

ESC B no value

The bar graph with the number **n1** (1..16) is set to the new value (**sv** <= **value** <= **ev**). If **value** > **ev**, the end value (**ev**) is displayed. The bar graph must be defined first (see above).

Example: \$1B \$42 \$01 \$0A

Bar graph no. 1 defined in the above example is set to a value of 10.

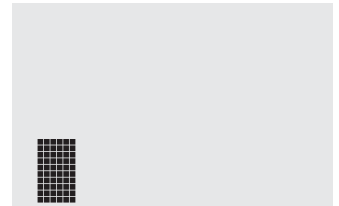
Draw bar graph**ESC D L/I/S****Change contents of display**

The entire contents of the display are deleted (**L** - white), inverted (**I**) or filled (**S** - black).

Example: \$1B \$44 \$49

Inverts the entire contents of the display.

ESC D A/E**Switch display on/off**

Switches the contents of the display off (**A** - not visible) or on (**E** - visible). Outputs are still possible when it is switched off.

Example: \$1B \$44 \$41

The contents of the display are no longer visible after this command.

ESC E n1 data

Define character

You can define up to 21 characters yourself (depending on the font size). These characters then have the ASCII codes 1 to max. 21 and remain in an invisible screen RAM 128 bytes in size until the supply voltage is switched off. In the case of a 4x6 font, up to 21 characters can be defined, whereas only 8 characters can be defined for an 8x16 font. Please note that if you want to define several characters in different fonts, you must bear in mind that a character with code 1 of the 8x16 font, for example, requires the same amount of RAM as the characters with the codes 1 to 3 in the 4x6 font (see the adjacent table).

User-definable characters (code)			
4x6	6x8	8x1	16x16
5x6	8x8	8x8	16
1	1		
2	2	1	
3	3		1
4	4	2	
5	5		
6	6		
7	7	3	
8	8		
9	9	4	2
10	10		
11	11	5	
12	12		
13	13	6	3
14	14		
15	15	7	
16	16		
17	17	8	4
18	18		
19	19	9	
20	20		
21	21	10	8

Example 1:

\$1B \$45 \$01

\$04 \$0E \$15 \$04 \$04 \$04 \$04 \$00

Defines an arrow pointing upward for ASCII no. 1 using the 6x8 character set.

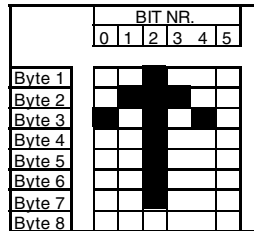

Example 2:

\$1B \$45 \$02

\$08 \$08 \$08 \$08 \$08 \$08 \$08 \$08 \$08 \$08 \$49 \$2A \$1C \$08 \$00 \$00

Defines an arrow pointing downward for ASCII no. 2 using the 8x16 character set.

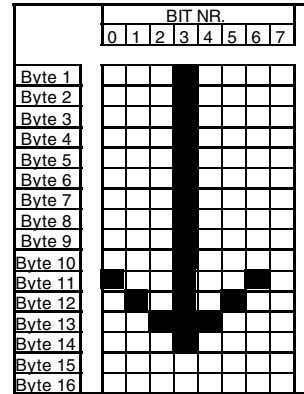

ESC F n1 n2 n3

Sets the font with the number **n1** (1=4x6 uppercase letters only; 2=6x8; 3=8x16). In addition, an enlargement factor (1..8 times) is set for the width (**n2**) and height (**n3**) separately.

Example: \$1B \$46 \$02 \$03 \$04

The 6x8 with 3 times the width and 4 times the height is set with immediate effect. In the adjacent figure, the character 'E' is shown in the 6x8 font and with various enlargement factors.

Set font

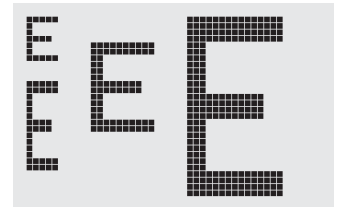

ESC F T n1

Set terminal font

Sets the font with the number **n1** for terminal operation. The font for the terminal is always used without zoom and in REPLACE mode.

Example: \$1B \$46 \$54 \$03

The 6x8 font is set as the terminal font with immediate effect.

ESC G x1 y1 x2 y2

Draw straight line

A straight line is drawn from **x1,y1** to **x2,y2** taking into account the graphics mode set 'V' (set/delete/inverse).

Example: \$1B \$47 \$03 \$14 \$28 \$06

A straight line is drawn from 3,20 to 50,6.

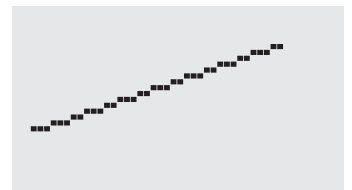

ESC H x1 y1 x2 y2

Create hard copy of display contents

Requests the area from the upper left corner (**x1,y1**) to the lower right corner (**x2,y2**). The graphics chip then immediately sends the width and height of the image section followed by the image data. See the upload image command ('U') for the structure of the image data.

Example: \$1B \$48 \$00 \$00 \$1F \$0F

The upper left part of the screen (32 x 16 pixels) is sent via RS-232.

ELECTRONIC ASSEMBLY

ESC J n1

Switch tone on/off manually

Switches the tone off (**n1=0**), on for an undefined period (**n1=1**) or on for n1/10 seconds (**n1=2..255**). (This only applies to versions with EA KIT160-6LEDTP touch panel.)

Example: \$1B \$4A \$0A

The tone sounds for 1 second after this command.

ESC K A add

Assign address

Assigns an address to the EA KIT160 (**add=0..254**). The best place for this command is in the power-on macro.

Example: \$1B \$4B \$41 \$01

The EA KIT160 is assigned the address \$01 with immediate effect.

ESC K S/Dadd

(De)select KIT160

Selects (**S**) or deselects (**D**) the EA KIT160 with the address **add** (0..254); the address 255=\$FF is a master address for all EA KIT160 units.

Example: \$1B \$4B \$44 \$01

All commands for the EA KIT160 with the address \$01 are ignored with immediate effect.

ESC L n1 pat

Set text mode

Sets the link mode (**n1**) and pattern (**pat**) for the string output text function (**ESC Z**).

Example: \$1B \$4C \$03 \$03

Sets the link mode for all subsequent text functions to gray characters (pattern 3 = 50% gray) inverted with the background.

Link mode n1:

- 1 = set: black pixels irrespective of the previous value (OR)
- 2 = delete: white pixels irrespective of the previous value
- 3 = inverse: changes black pixels to white pixels and vice versa (EXOR)
- 4 = replace: deletes the background and sets black pixels
- 5 = inverse replace: fills the background and sets white pixels

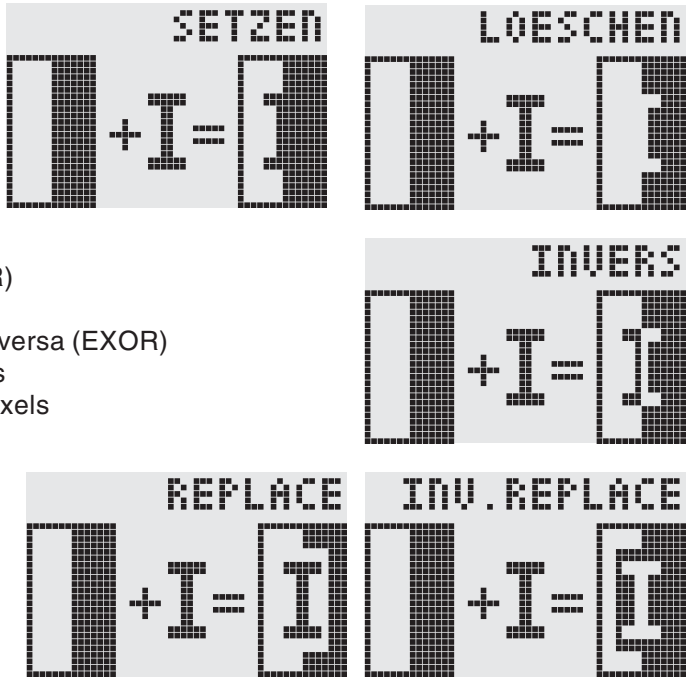

ESC M N/T/P n1

Call macro

Calls the normal macro (N), touch macro (T) or port macro (P) with the number n1 (0..255).

Example: \$1B \$4D \$4E \$0F

The (normal) macro with the number 15 is executed.

ESC M A/Jn1 n2 n3

Execute macros automatically

Calls the normal macros with the numbers n1 to n2 automatically every n3/10 seconds. A=cyclical call (e.g. 1,2,3,4,1,2,3,4, etc.); J=ping-pong call (e.g. 1,2,3,4,3,2,1,2,3,4, etc.).

Automatic execution is terminated:

- When a character is received from the RS-232 interface
- When a touch automatically executes a touch macro
- When an input change executes a port macro

Example: \$1B \$4D \$41 \$01 \$03 \$05

The macros with the numbers 1, 2 and 3 are executed automatically with a break of 1/2 second.

ESC N H/Vx1 y1 no Text... NUL

Display menu

Defines and displays a menu with the current font. The background of the menu box is automatically saved on the clipboard (**the previous contents of the clipboard are lost**): H=horizontal menu at x1,y1 (upper left corner) or V=vertical menu (rotated 90°) at x1,y1 (upper right corner). n1=currently inverted item; Text...=string containing the items. The individual items are separated by the character '|' (= \$7C). The string must be terminated with NUL= \$00.

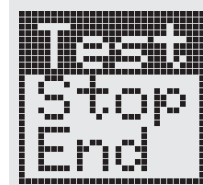

Example 1 - Horizontal menu:

\$1B \$4E \$48 \$02 \$02 \$01

\$54 \$65 \$73 \$74 \$7C \$53 \$74 \$6F \$70 \$7C \$45 \$6E \$64 \$00

Defines a horizontal menu containing the items "Test", "Stop" and "End" at position 2,2. The 1st item is inverted.

Example 2 - Vertical menu:

\$1B \$4E \$56 \$28 \$01 \$01

\$54 \$65 \$73 \$74 \$7C \$53 \$74 \$6F \$70 \$7C \$45 \$6E \$64 \$00

Defines a vertical menu containing the items "Test", "Stop" and "End" at position 40,1. The 1st item is inverted.

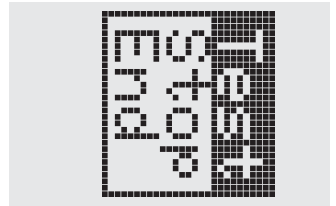

ESC N N/P

Next/previous menu item

Inverts the next (N) or previous (P) menu item. If the last/first item is already inverted, the command is ignored.

Example: \$1B \$4E \$4E

The next menu item is inverted.

ESC N I

Invert menu box

Inverts the entire menu box.

Example: \$1B \$4E \$49

ESC N S

Terminate and send menu

Removes the menu from the display and restores the background. The currently selected item is sent as a number (1..max. item) via the RS 232 interface.

Example: \$1B \$4E \$53

ESC N M n1

Terminate menu and call macro

Removes the menu from the display and restores the background. If item 1 is selected, the (normal) macro with the number n1 is called, for item 2 the macro n1+1 etc.

Example: \$1B \$4E \$4D \$0A

ESC N A

Cancel menu

Removes the menu from the display and restores the background.

Example: \$1B \$4E \$41

ELECTRONIC ASSEMBLY

ESC O n1 n2**Position cursor**

Sets the cursor to column **n1** and row **n2** for terminal operation. The origin in the upper left corner is 1,1.

Example: \$1B \$4F \$03 \$05

Sets the cursor to the 3rd column in row 5.

ESC P x1 y1**Set dot**

Sets a pixel at **x1,y1** taking into account the graphics set mode 'ESC V' (set/delete/invert).

Example: \$50 \$11 \$0D

Sets the pixel at 17,13.

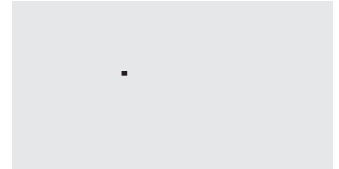
**ESC Q C n1****Cursor on/off**

n1=1: Switches the cursor on; it flashes at the current position on the terminal.

n1=0: Switches the cursor off.

Example: \$1B \$51 \$43 \$01

Switches the cursor off.

ESC Q D x1 y1 x2 y2**Define flashing area**

Defines the area from the upper left corner (**x1,y1**) to the lower right corner (**x2,y2**) as an automatically flashing area. The flashing function is started at the same time. This deactivates the terminal cursor.

Example: \$1B \$51 \$44 \$00 \$0F \$07 \$10

Defines the flashing area from 0,15 to 7,16.

ESC Q Z n1**Set flashing time**

Sets the flashing time to **n1** (=1..15) tenths of a second. When **n1= 0**, the flashing function is deactivated and the original screen restored.

Example: \$1B \$51 \$5A \$03

Sets the flashing time to 0.3 seconds.

ESC R R x1 y1 x2 y2**Draw rectangle**

Draws a rectangle from the upper left corner (**x1,y1**) to the lower right corner (**x2,y2**) taking into account the set graphics mode 'V' (set/delete/inverse). The contents of the rectangle are not changed. See 'ESC R O' (Draw box).

Example: \$1B \$52 \$52 \$15 \$08 \$30 \$25

Draws a rectangle from 21,8 to 48,37.

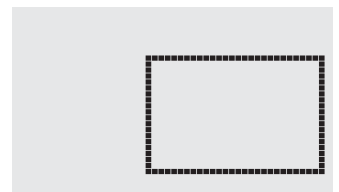

ESC R N x1 y1 x2 y2

Draw rounded rectangle

Draws a rectangle with rounded corners from the upper left corner (**x1,y1**) to the lower right corner (**x2,y2**) taking into account the set graphics mode 'V' (set/delete/inverse). The contents of the rounded rectangle are not changed. See 'ESC R J' (Rounded box).

Example: \$1B \$52 \$4E \$06 \$02 \$26 \$13

Draws a rounded rectangle from 6,2 to 38,19.

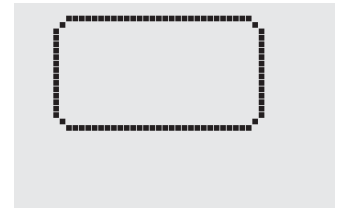

ESC R L x1 y1 x2 y2

Deletes the area from the upper left corner (**x1,y1**) to the lower right corner (**x2,y2**).

Example: \$1B \$44 \$53 \$1B \$52 \$4C \$06 \$04 \$28 \$19

The display is filled with **ESC D S** and then deleted from 6,4 to 40,25.

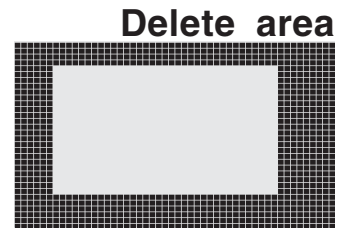

Delete area

ESC R I x1 y1 x2 y2

Inverts the area from the upper left corner (**x1,y1**) to the lower right corner (**x2,y2**) (black pixels turn white and vice versa).

Example: \$1B \$52 \$49 \$00 \$00 \$17 \$1B

Inverts the area from 0,0 to 23,27 with the display contents from the "Set font" example.

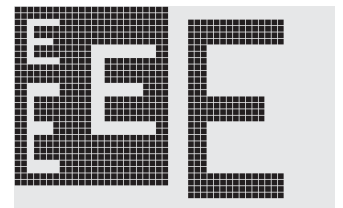

Invert area

ESC R S x1 y1 x2 y2

Fills the area from the upper left corner (**x1,y1**) to the lower right corner (**x2,y2**) (sets the pixels to black).

Example: \$1B \$52 \$53 \$09 \$05 \$16 \$16

Sets the area from 9,5 to 22,22 black.

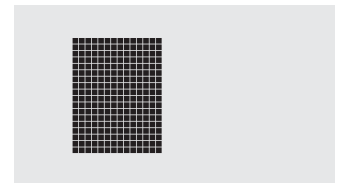

Fill area

ESC R M x1 y1 x2 y2 pat

Fills a rectangular area from the upper left corner (**x1,y1**) to the lower right corner (**x2,y2**) with the pattern **pat** taking into account the set graphics mode "ESC V" (set/delete/invert/replace/inverse replace).

Example: \$1B \$52 \$4D \$05 \$01 \$2D \$1A \$07

Fills the area with the pattern 7=45°cross from 5,1 to 45,26.

Fill area with pattern

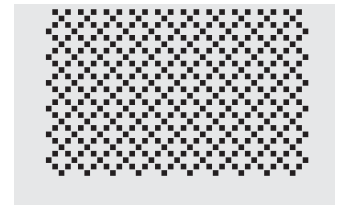

ESC R O x1 y1 x2 y2 pat

Draws a rectangle from the upper left corner (**x1,y1**) to the lower right corner (**x2,y2**) with the pattern **pat**. The background of the box is deleted. See 'ESC R R' (Draw rectangle).

Example: \$1B \$52 \$4F \$02 \$05 \$12 \$1E \$02

Draws a box from 2,5 to 18,30 with the pattern 2=25%gray.

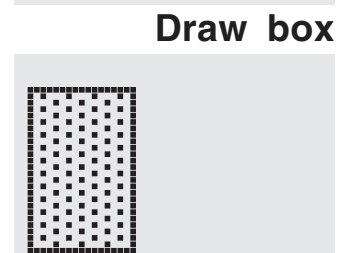

Draw box

ESC R J x1 y1 x2 y2 pat

Draws a rectangle with rounded corners from the upper left corner (**x1,y1**) to the lower right corner (**x2,y2**) with the pattern **pat**. The background is deleted. See 'ESC R N' (Draw rounded rectangle).

Example: \$1B \$52 \$4A \$07 \$03 \$23 \$16 \$03

Draws a rounded box from 7,3 to 35,22 with the pattern 3=50%gray.

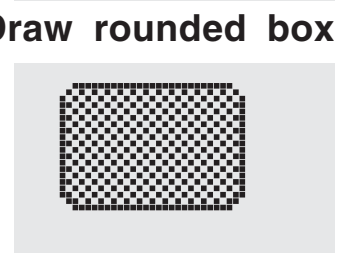

Draw rounded box

ESC S num data...

Send bytes via RS-232

Outputs the next **num** (1..255, 0=256) bytes at the serial interface.

Example: \$1B \$53 \$04 \$54 \$45 \$53 \$54

Transmits the word 'TEST' via the RS-232C interface.

ELECTRONIC ASSEMBLY

ESC T H/Vf1 f2 ret frm text... NUL**Define touch key**

Defines a touch key and labels it with the current font. **H**=horizontal or **V**=vertical labeling (rotated 90°). Several touch fields can be grouped together to form a single touch key (**f1**=upper left touch field; **f2**=lower right touch field of the new touch key). This touch key is assigned a return code with **ret** (1..255). When the touch key is touched, the touch macro with the number **ret** is called or, if no touch macro is defined, this return code is sent via the RS232. You use **frm** to define the format of the touch key (frm=0: don't draw anything; frm=1: delete touch key; frm=2: delete touch key and draw with frame). **text...**=string with the label (which is always centered on the touch key). The label can also have more than one line; in this case, the lines are separated by the character '|' (= \$7C). The string must be concluded with **NUL**= \$00. See example on page 3.

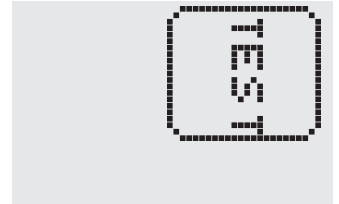
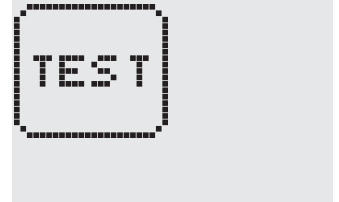
Example 1: Horizontal touch key:

```
$1B $54 $48 $01 $01 $41 $02 $54 $45 $53 $54 $00
```

Defines a horizontal touch key (field no. 1 only) with the return code 65='A'. The touch key is drawn with a frame and labeled with the word 'TEST'.

Example 2: Vertical touch key:

```
$1B $54 $56 $02 $02 $42 $02 $54 $45 $53 $54 $00
```

Defines a vertical touch key (touch field no. 2 only) with the return code 66='B'. The touch key is drawn with a frame and labeled with the word 'TEST'.

ESC T P/R**Preset/reset touch fields**

Assigns **P** (=ascending return code: 1..32) or **R** (=reset all touch fields) to all 32 touch fields. In the latter case all touch fields receive the return code 0 (i.e. they are deactivated).

Example: \$1B \$54 \$52

All touch fields are deactivated by this command and no longer recognized.

ESC T I/S n1**Touch key response**

These commands set the automatic response of the touch panel to touching. Both responses can be activated simultaneously.

I=automatic inversion when the touch key is touched (**n1**=0: off or **n1**=1: on)

S=automatic signal tone when the touch key is touched (**n1**=0: off or **n1**=1: on)

Example: \$1B \$54 \$49 \$01

After this command the tone sounds when a touch key is touched.

ESC T M ret**Invert touch key manually**

This command manually inverts the touch key with the return code **ret**.

Example: \$1B \$54 \$4D \$41

Inverts the touch key from the above example with the return code 65='A'.

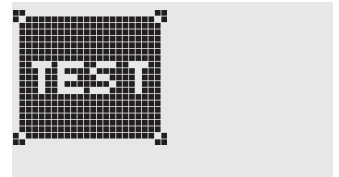
**ESC T A n1****(Touch) key query on/off**

This command sets the (touch) key query:

n1=0: Switches the key query off - no touch macros or manual key query possible.

n1=1: Activates the key query - keystrokes trigger touch macros or are sent via RS232.

n1=2: Activates the key query - keystrokes trigger touch macros; must be queried manually.

Example: \$1B \$54 \$41 \$02

Activates the (touch) key query. The keystrokes are not sent automatically via RS232; they have to be requested manually by means of the command **ESC T W**.

ESC T W**Query touch key manually**

Sends the return code of the currently depressed touch key at the RS232.

Example: \$1B \$54 \$57

ESC U E x1 y1 n1

Load image from EEPROM

Displays the image saved in the EEPROM with the number **n1** (0..255) at position **x1,y1**.

Example: \$1B \$55 \$45 \$02 \$03 \$0E Displays image number 14 from the EEPROM at position 2,3.

ESC U L x1 y1 data...

Upload image

Displays an image at position **x1,y1**.

data...:

- 1 byte for the image width in pixels
- 1 byte for the image height in pixels
- Image data: number = $((width+7) / 8) * height$ bytes.
- 1 byte stands for 8 horizontal pixels on the screen; 0=white, 1=black;
- LSB: left, MSB: right; the image is stored from the top down.
- The BMP2BLH.EXE -m program on the EA DISK240 floppy disk available as an accessory creates the image data, including the width and height, from monochrome Windows bitmap graphics (*.BMP).

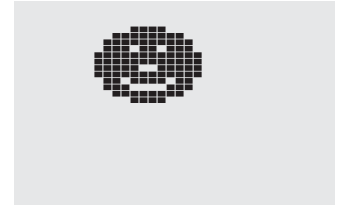

Example:

```
$1B $55 $4C $09 $04 $0C $0C
$F0 $00 $FC $03 $FE $07 $6E $07 $FF $0F $FF $0F
$9F $0F $FF $0F $F6 $06 $0E $07 $FC $03 $F0 $00
```

Loads the adjacent image at position 9,4.

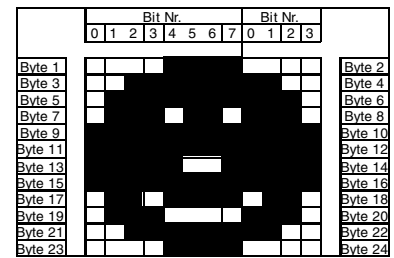

ESC V n1

Set graphics mode

Sets the link mode **n1** for the following graphics functions: ESC P (Set point), ESC G (straight line), ESC W (Continue straight line), ESC R R (rectangle), ESC R N (rounded rectangle), ESC R M (Fill area with pattern).

Example: \$1B \$56 \$03

Sets the link mode to inverse.

By way of example, a rectangle is drawn alongside with the link modes set, delete and inverse on an existing background.

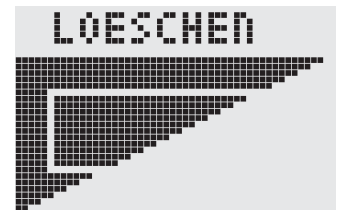
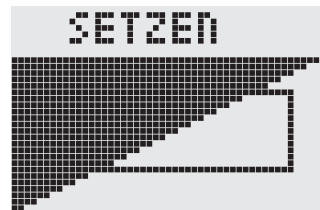

Link mode n1:

- 1 = set: black pixels irrespective of the previous value (OR)
- 2 = delete: white pixels irrespective of the previous value
- 3 = inverse: changes black pixels to white pixels and vice versa (EXOR)
- 4 = replace: deletes the background and sets black pixels; only area with fill pattern
- 5 = inverse replace: fills background and sets white pixels; only area with fill pattern

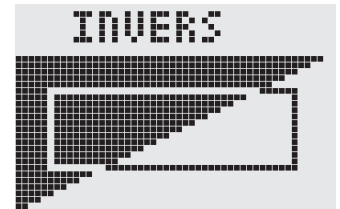

ESC W x1 y1

Continue straight line

Continues a straight line from the last end or point drawn to **x1,y1** taking into account the set graphics mode 'V'.

Example:

```
$1B $47 $00 $00 $10 $04
$1B $57 $16 $1B
$1B $57 $30 $0F
```

A straight line is drawn from 0,0 to 16,4. It is then continued to 22,27 and to 48,15.

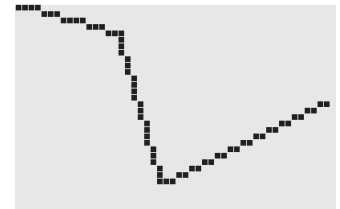

ESC X n1

Wait/pause

This command suspends the EA KIT160 for **n1/10** seconds.

Example: \$1B \$58 \$0A

After this command the EA KIT160 waits for a second before the next command is processed.

ESC Y R n1

Read input port

Reads in the input port (**n1=1..8 = IN1..IN8**). When **n1=0**, all the inputs are read in as 8-bit binary values (MSB:IN8...IN1:LSB); see application on page 5. The command "ESC Y I 1" puts this right (input open: 0).

Example: \$1B \$59 \$52 \$03

Reads in port IN3. The result is sent via RS232.

ELECTRONIC ASSEMBLY

ESC Y W n1 n2**Write output port**

Changes the output port ($n1=1..8 = \text{OUT1}..\text{OUT8}$) to the value $n2$ (0=low level; 1=high level; 2=invert port). When $n1=0$, all the outputs are output as a binary value $n2$ (MSB:OUT8...OUT1:LSB); see application on page 5.

Example: \$1B \$59 \$57 \$02 \$01

Switches the output port OUT2 to high level.

ESC Y A n1**Automatic port query on/off**

Each change at the input port (8-bit binary value IN8..IN1) can call a port macro (0..255). This command activates ($n1=1$) or deactivates ($n1=0$) the automatic port query. After power-on, the current port status is read and the associated port macro executed immediately.

Example: \$1B \$59 \$41 \$01

Activates the automatic port query and executes the associated port macro.

ESC Y I n1**Invert input port**

This command allows the logic of the input port to be inverted ($n1=0$ for normal or $n1=1$ for inverse). This is useful with the optocoupler inputs, for example.

Example: \$1B \$59 \$49 \$01

Inverts the input port logic.

ESC Y L n1**LED backlight On/Off**

LED backlight is switched off ($n1=0$) or permanently on ($n1=1$). At $n1=2$ backlight is inverted (on->off, off->on). $n1=3..255$ turns the backlight $n1/10$ sec. on and then off. Note: LED backlight is the same line as output port 8. If you need to use output port 8 then you have to cut backlight from output 8 by changing the solder strip LB8. Backlight will be turned on and cannot controlled by software anymore.

ESC Z L/Z/R x1 y1 text... NUL**Horizontal string**

Writes the string **text...** left justified (**L**), centered (**Z**) or right justified (**R**) at position $x1$ taking into account the set text mode (**ESC L**). Multi-line text can also be output, with the lines separated by the character '|' ($=\$7C$). The string must be concluded with **NUL** = \$00. Position $y1$ is the upper edge of the 1st line.

Example 1: Writes the text "Left|Ok" left justified at 0,0.

\$1B \$5A \$4C \$00 \$00 \$4C \$65 \$66 \$74 \$7C \$4F \$6B \$00

Example 2: Writes the text "Center|Ok" centered at 25,0.

\$1B \$5A \$5A \$19 \$00 \$43 \$65 \$6E \$74 \$65 \$72 \$7C \$4F \$6B \$00

Example 3: Writes the text "Right|Ok" right justified at 49,0.

\$1B \$5A \$52 \$31 \$00 \$52 \$69 \$67 \$68 \$74 \$7C \$4F \$6B \$00

Left|
Ok

Center|
Ok

Right|
Ok

ESC Z O/M/U x1 y1 text... NUL**Vertical string**

Writes the string **text...** rotated by 90° degrees top justified (**O**), vertically centered (**M**) or bottom justified (**U**) at position $y1$ taking into account the text mode (**ESC L**). Multi-line text can also be output, with the lines separated by the character '|' ($=\$7C$). The string must be concluded with **NUL** = \$00. Position $x1$ is the right edge of the 1st line.

Example 1: Writes the text "Top|Ok" top justified at 49,0.

\$1B \$5A \$4F \$31 \$00 \$54 \$6F \$70 \$7C \$4F \$6B \$00

Example 2: Writes the text "Mid|Ok" vertically centered at 49,15.

\$1B \$5A \$4D \$31 \$0F \$4D \$69 \$64 \$7C \$4F \$6B \$00

Example 3: Writes the text "Bot|Ok" bottom justified at 49,31.

\$1B \$5A \$55 \$31 \$1F \$42 \$6F \$74 \$7C \$4F \$6B \$00

Top|
Ok

Mid|
Ok

Bot|
Ok

EA KIT160-6

DIMENSIONS

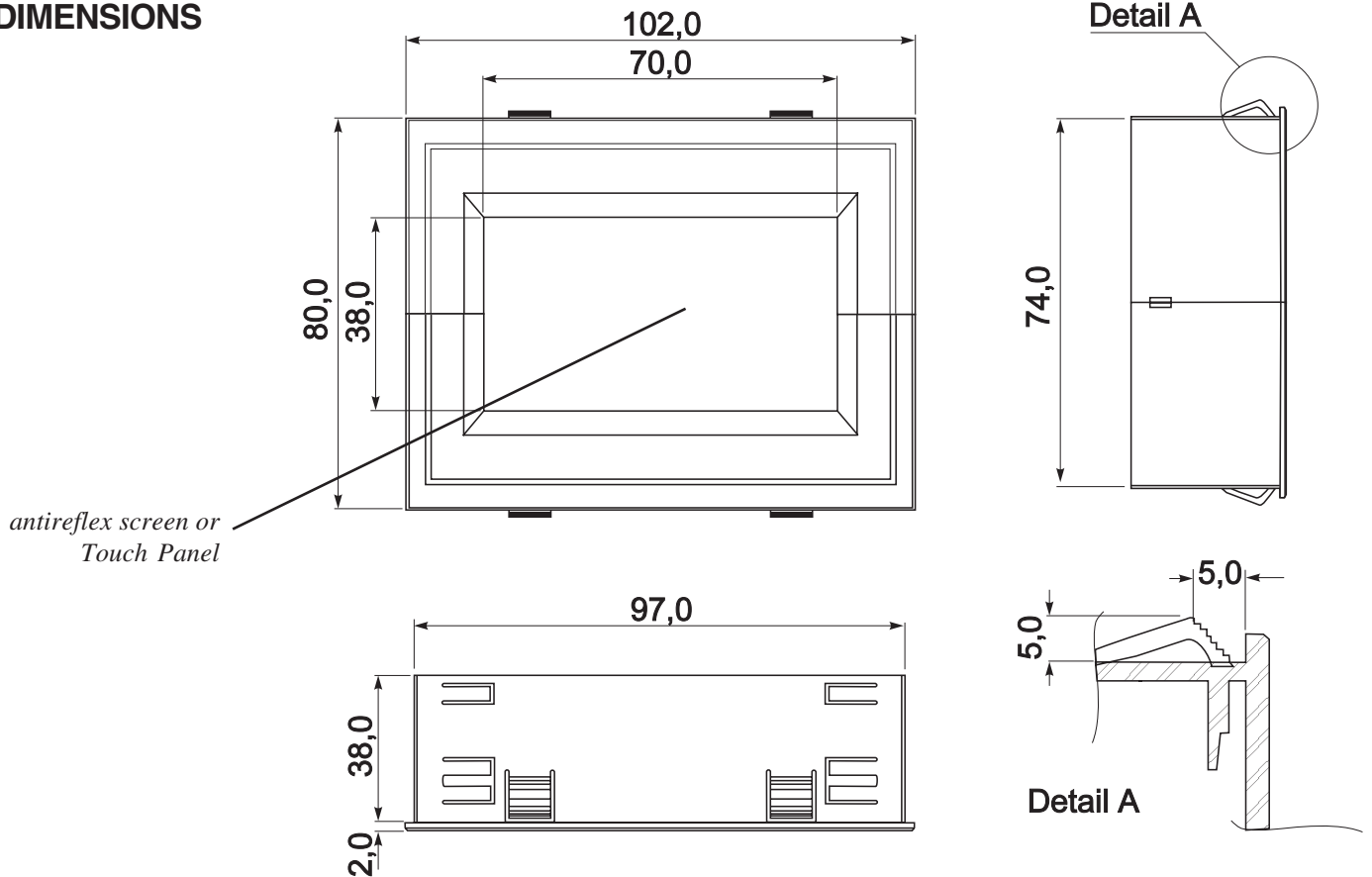

all dimensions are in mm
panel cutout 97,5x75,0 mm

HINTS FOR HANDLING AND OPERATING

- The module can be destroyed electrically by mispoled or overvoltage power supply, wrong polarity, overvoltage or static discharge on inputs or shortened outputs.
- Before disassembling the module, the power supply must be switched off. Also all inputs must not carry any current.
- Display, touch screen and cover glass are scratch- sensitive plastic materials and should not be touched with hard objects.
- Surfaces should be cleaned with soft fabric without using of chemical solvents.
- The module is designed for indoor use only. For operating in outside environment adequate precautions must be undertaken. Maximum operating temperature range from 0..+50°C should be not exceeded. In humid atmosphere or in condensing situations the module functions may drop out. Direct sun exposure to the display should be avoided. Storage temperature range is -20..+70°C.



Данный компонент на территории Российской Федерации

Вы можете приобрести в компании MosChip.

Для оперативного оформления запроса Вам необходимо перейти по данной ссылке:

<http://moschip.ru/get-element>

Вы можете разместить у нас заказ для любого Вашего проекта, будь то серийное производство или разработка единичного прибора.

В нашем ассортименте представлены ведущие мировые производители активных и пассивных электронных компонентов.

Нашей специализацией является поставка электронной компонентной базы двойного назначения, продукции таких производителей как XILINX, Intel (ex.ALTERA), Vicor, Microchip, Texas Instruments, Analog Devices, Mini-Circuits, Amphenol, Glenair.

Сотрудничество с глобальными дистрибьюторами электронных компонентов, предоставляет возможность заказывать и получать с международных складов практически любой перечень компонентов в оптимальные для Вас сроки.

На всех этапах разработки и производства наши партнеры могут получить квалифицированную поддержку опытных инженеров.

Система менеджмента качества компании отвечает требованиям в соответствии с ГОСТ Р ИСО 9001, ГОСТ РВ 0015-002 и ЭС РД 009

Офис по работе с юридическими лицами:

105318, г.Москва, ул.Щербаковская д.3, офис 1107, 1118, ДЦ «Щербаковский»

Телефон: +7 495 668-12-70 (многоканальный)

Факс: +7 495 668-12-70 (доб.304)

E-mail: info@moschip.ru

Skype отдела продаж:

moschip.ru

moschip.ru_4

moschip.ru_6

moschip.ru_9