

TRIMMER CAPACITORS

TUSONIX continues to lead the way in the miniaturization of ceramic trimmers. Developments such as the miniaturization of Trimmer Capacitors have established TUSONIX as a leader in state-of-the-art trimmer technology.

Table of Contents

McQ 512 Series	Page 1
513 Series.	Page 2
518 Series.	Page 3
528 Series.	Page 4
538 Series.	Page 5
Specifications	Page 6

Tusonix Quality

Quality and value are the key ingredients in all TUSONIX products with approval to MIL-PRF-15733, MIL-PRF-81 and MIL-C-11015. TUSONIX maintains a fully approved Quality Assurance laboratory and relies heavily on Statistical Process Control to monitor critical operations.

McQ 512 Series Trimmer Capacitor - Extra Miniaturized

Outstanding Features

- ◆ Ceramic Base & Dielectric - Very Stable
- ◆ Small Footprint - Save PCB Space
- ◆ High Q Factor - Ultra High Frequency Applications
- ◆ Wide Temperature Range - Functional under Extreme Conditions
- ◆ SMD on Tape and Reel - Suitable for Automatic Pick and Place



The Tusonix McQ 512 Trimmer is perfect for an endless variety of applications that require miniaturized capacitance trimming, including avionics apparatus, communications equipment, oscilloscopes, crystal oscillators and crystal filters.

By way of a unique manufacturing process, Tusonix offers a high quality product through low cost production, which means an attractive price for our customers. The dynamically designed McQ 512 Trimmer offers strong characteristics, including tape and reel feed, solder pad mount and small footprint.

Dimensions of McQ 512



Ordering Data

Part No.	Dielectric Type Code	Temp. COEF. PPM/°C	Cap pF	WVDC @125°C	Q Min.
0512-000	A	NPO ±200	1.0-3	100	750
0512-000	A	NPO ±200	1.5-5	100	750
0512-000	A	NPO ±400	3.0-10	100	500
0512-000	A	NPO ±400	4.5-20	100	500
0512-000	A	NPO ±400	5.0-25	100	300

Please combine part no., Dielectric Type Code and Cap pF when ordering. Example: 0512-000A3.0-10.

Specifications

Torque	0.14-2.0 oz-in/0.1-1.4 Ncm
Working Voltage	100 VDC
Dielectric Strength	200 VDC
Operating Temperature Range	-55°C +125°C
Q @ 1 MHz.	300 to 750
Tuning019 [0.48] Slot

Packaging: 12mm Tape & Reel per IEC No. 60286-3, Type II Available for Automatic Placement



The products listed in this catalog are only a few of the thousands of variations that TUSONIX produces. For custom applications please contact the factory direct.



513 Series Trimmer Capacitor



Outstanding Features

- ◆ Only .196"/4.98mm diameter x .100"/2.54 mm MAX high.
- ◆ Ideal for wide range of products requiring real miniaturized capacitance trimming.
- ◆ Operates efficiently at -55°C to +85°C.
- ◆ Available in your choice of three basic terminal arrangements.
- ◆ No metal or mechanical attachments protruding beneath the base plane.
- ◆ Monolithic Rotor design offers optimum stability for higher capacitance ranges. Eliminates need to use unstable higher K dielectric materials. Monolithic construction offers greater ruggedness which cannot be achieved when using single plate construction, particularly with fragile Hi-K Dielectric materials.

Terminal Variations

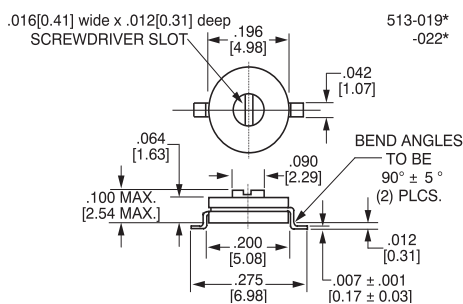
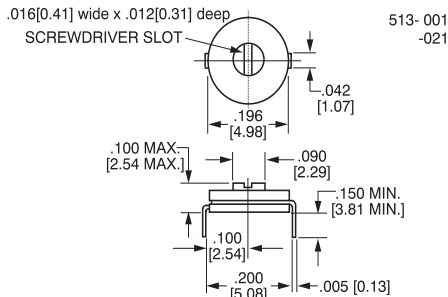
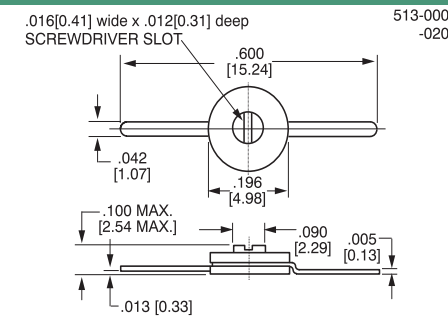

*Variation 513-019, -022 is supplied on tape and reel, for auto placement

For dimensions $\leq .125"/3.18\text{mm}$, tolerance is $\pm .005/0.13$

For dimensions $\geq .126"/3.20\text{mm}$, tolerance is $\pm .015/0.38$

Applications

The 513 VARI-Thin Ceramic Trimmer Capacitor is another miniaturized offering. Only .196" in diameter and .080" high the TUSONIX 513 is perfect for avionics apparatus, communications equipment, oscilloscopes, crystal oscillators,

and crystal filters—an almost endless variety of applications requiring miniaturized capacitance trimming. The tiny 513 VARI-Thin is available with three basic terminal arrangements as shown at left.

Ordering Data

	-000, -001, -019 Cap. (pF)	Dielectric Type Code	-020, -021, -022 Cap. (pF)
Begin with '0', specify series 513 followed by the three digit variation you select from the chart at the left. Then list the Dielectric type code from the table at the right and the corresponding Capacitance Range. Example: 0513-000A1-5		A	1.0-2.5
		A	1.5-3.0
	1.0-5.0	A	2.0-5.0
		A	2.5-9.0
	2.0-10.0	A	4.5-14.0
		A	
	3.5-20.0	A	
	5.0-30.0	A	
	6.0-35.0	A	
	7.0-40.0	F	6.0-20.0
	A		

Minimum to maximum capacitance achieved through 180° rotation.

Specifications

Working Voltage 100Vdc to 85°C
 Dielectric Strength Two Times WVdc for 1 to 5 seconds
 Operating Temperature Range -55°C to +85°C
 Q Factor @ 1 MHz 500 Min. (Dielectric Code A & F)
 Insulation Resistance. 10 gigaohms minimum at 25°C ±5°C
 Torque 0.3 to 2.0 oz.in.[0.2-1.4 Ncm]
 Performance Specification. Page 6

For other capacitance ranges and terminal arrangements, call the nearest TUSONIX Sales office or call Tusonix Headquarters at (520) 744-0400.

518 Series Trimmer Capacitor



Features of the 518 Trimmer

This tiny trimmer occupies less than .007 [.11 cc] cubic inches of space, while exhibiting the ruggedness and capacitance range of a unit many times its size. Its superb design assures rigid mounting stability.

A development of TUSONIX' exclusive Monolithic Process, the sealed-in-ceramic rotor electrode guarantees stability under extreme environmental conditions. Precision lapped bearing surfaces afford smooth linear tuning.

Terminal Variation Options



For dimensions $\leq .125"/3.18\text{mm}$, tolerance is $\pm .005/0.13$
 For dimensions $\geq .126"/3.20\text{mm}$, tolerance is $\pm .015/0.38$

How to Order

Begin with '0', then specify series '518' followed by the three digit Terminal Variation you select from the above options. Then list the Dielectric Type Code you select from the table and the corresponding Capacitance Range.

EXAMPLE: 0518-000A1.0-3

Ordering Data

TUSONIX Part Number	MIL PRF-81 Designation CV35 TUSONIX Style 518-016	Dielectric Type Code	Capacitance Range (pF)	TUSONIX Part Number	MIL PRF-81 Designation CV36 TUSONIX Style 518-017	Dielectric Type Code	Capacitance Range (pF)
518-000	CV35A030	A	1.0-3	518-002	CV36A030	A	1.25-3
518-000	CV35A050	A	2.0-5	518-002	CV36A050	A	2.0-5
518-000	CV35A090	A	2.5-9	518-002	CV36A090	A	2.5-9
518-000	CV35A200	A	3.5-20	518-002	CV36A200	A	3.5-20
518-000	CV35A150	A	5.0-15	518-002	CV36A150	A	5.0-15
518-000	CV35A250	A	5.0-25	518-002	CV36A250	A	5.0-25
518-000	--	A	6.0-22	518-002	--	A	6.0-22
518-000	CV35C400	C	7.0-40	518-002	CV36C400	C	7.0-40

Specifications

Working Voltage A & C: 100Vdc to 85°C; 50Vdc to 125°C
 Dielectric Strength Two times WVdc for 1 to 5 seconds
 Operating Temperature Range -55°C to 125°C
 Q Factor @ 1 MHz Code A & C: 500 Minimum
 Insulation Resistance. 10 gigaohms minimum at 25°C $\pm 5^\circ\text{C}$
 Torque. 0.3 to 3.0 oz. in. [0.2-2.0 Ncm]
 Performance Specification Page 6

Marking: All units will be marked with the TUSONIX trademark, capacitance range and dielectric type code.

Example: T 1-3 A



The products listed in this catalog are only a few of the thousands of variations that TUSONIX produces. For custom applications please contact the factory direct.



528 Series Trimmer Capacitor



Features of the 528 Trimmer

Incorporating the same fine design features that have made the 538 Series standard for the industry, TUSONIX' 528 Series featured here is miniaturized for today's circuitry. All ceramic construction with optically flat interfaces provides tuning, smoothness not obtainable with compression type trimmers. The silver electrodes are intimately bonded to the top surfaces of the base and rotor. The terminals and other metal parts are nonferrous and silver-plated for good conductivity and trouble free soldering.

A variety of capacitance ranges, terminations and mounting provisions make these popular trimmers ideal for nearly all applications.

Terminal Variation Options



For dimensions $\geq .126"/3.20\text{mm}$, tolerance is $\pm .015/0.38$
 For dimensions $\leq .125"/3.18\text{mm}$, tolerance is $\pm .005/0.13$

How to Order

Begin with '0', then specify series '528' followed by the three digit Terminal Variation you select from the above options. Then list the Dielectric Type Code you select from the table and the corresponding Capacitance Range.

EXAMPLE: 0528-002F6.0-22

Ordering Data

TUSONIX Part Number	Dielectric Type Code	Capacitance Range (pF)	TUSONIX Part Number	Dielectric Type Code	Capacitance Range (pF)
528-000	A	1.0-3	528-002	A	1.25-3
528-000	A	2.0-5	528-002	A	2-5
528-000	A	3.0-8	528-002	A	3-8
528-000	A	3.5-10	528-002	A	3.5-10
528-000	C	3.5-10	528-002	C	3.5-10
528-000	A	4.0-14	528-002	A	4-14
528-000	E	4.5-15	528-002	E	4.5-15
528-000	F	3.5-17	528-002	F	3.5-17
528-000	F	6.0-22	528-002	F	6-22

Specifications

Working Voltage: 100Vdc at 125°C
 Dielectric Strength 200 WVdc for 1 to 5 seconds
 Operating Temperature Range -55°C to 125°C
 Q Factor @ 1 MHz 500 Min
 Insulation Resistance. .10 gigaohms minimum at 25°C $\pm 5^\circ\text{C}$
 Torque. 0.3 to 3.0 oz. in. [0.2-2.0 Ncm]
 Performance Specification Page 6

Marking: All units will be marked with the TUSONIX trademark, capacitance range and dielectric type code.

Example: T 1-3•

538 Series Trimmer Capacitor



TUSONIX's 538 Series featured on this page is miniaturized for today's circuitry. All ceramic construction with optically flat interfaces provides tuning smoothness not obtainable with compression type trimmers.

The silver electrodes are intimately bonded to the top surfaces of the base and rotor. The terminals and other metal parts are nonferrous and silver-plated to provide excellent conductivity and trouble free soldering.

A variety of capacitance ranges, terminations and mounting provisions makes these popular trimmers ideal for nearly all applications.

Dimensions



Ordering Data

	MIL PRF-81 Designation CV31 TUSONIX Style 538-054	MIL PRF-81 Designation CV32 TUSONIX Style 538-067	Dielectric Type Code	Capacitance Range (pF)
Specify series 538 followed by the three digit Terminal Variation you select from the chart below. Then list the Dielectric type code from the table at the right and the corresponding Capacitance Range. EXAMPLE: 538-002 A 2-8	CV31A080	CV32A080	A	2.0 to 8
	CV31B110	CV32B110	B	2.5 to 11
	--	--	A	3.0 to 10
	CV31C100	CV32C100	C	3.0 to 10
	CV31D150	CV32D150	D	3.0 to 15
	--	--	B	3.5 to 14
	CV31A180	CV32A180	A	5.5 to 18
	--	--	F	5.0 to 25
	--	--	D	5.5 to 25
	CV31B250	CV32B250	B	7.0 to 25
	CV31C250	CV32C250	C	8.0 to 25
	CV31D350	CV32D350	D	9.0 to 35
	CV31E600	CV32E600	F	15.0 to 60

Terminal Variation Options



Specifications

Working Voltage A,B,C:350Vdc @ 85°C
 200Vdc @ 125°C
 Working Voltage D & F:200Vdc @ 85°C
 100Vdc @ 125°C
 Dielectric Strength: 500 Vdc for 1-5 Sec.
 Operating Temp. Range:-55°C to 125°C
 Q Factor @ 1 MHz: 500 Minimum
 I.R.: 10 gigaohms min. at 25°C ±5°C
 Torque: 1.0-6.0 oz. in.[0.7-4.3 Ncm]
 Performance Specification: Page 6

Marking: All units will be marked with the TUSONIX trademark, capacitance range and dielectric type code.

Example: T 2-8 A

For dimensions $\leq .125"/3.18\text{mm}$, tolerance is $\pm .015/0.38$
 For dimensions $\geq .126"/3.20\text{mm}$, tolerance is $\pm .030/0.76$

The products listed in this catalog are only a few of the thousands of variations that TUSONIX produces. For custom applications please contact the factory direct.

Trimmer Capacitor Specifications

CAPACITANCE: When measured at room temperature ($25^{\circ}\text{C} \pm 5^{\circ}\text{C}$) and at a frequency of 0.1 to 1 Megahertz, the minimum capacitance shall not be greater than that specified at minimum setting with a +10% tolerance and the maximum capacitance shall not be less than that specified maximum setting with a - 10% tolerance.

“Q” FACTOR: When measured at room temperature ($25^{\circ}\text{C} \pm 5^{\circ}\text{C}$) and at a frequency of approximately 1 Megahertz, the capacitor at approximately maximum rated capacitance setting shall have a “Q” Value not less than indicated for the respective style.

INSULATION RESISTANCE: The I.R. at approximately maximum capacitance setting shall be 10 gigaohms minimum at $25^{\circ}\text{C} \pm 5^{\circ}\text{C}$ when measured at 100 volts dc. The voltage shall be applied through a protective series resistance not exceeding 1 megaohm. The electrification time shall not exceed 1 minute.

DIELECTRIC STRENGTH: The capacitor, set at approximately maximum capacitance, shall withstand voltage between terminals for 1 to 5 sec. as indicated for the respective style. The surge current shall be limited to 50mA maximum.

TORQUE: When measured $25^{\circ}\text{C} \pm 5^{\circ}\text{C}$, the torque required to start and maintain rotation of the rotor through one full turn, shall be as indicated for the respective style.

TEMPERATURE CHARACTERISTIC: The T.C. of capacitance shall be within the limits shown in the table to the right. The T.C. shall be determined by measuring the capacitance (capacitor shall be set at approximately 75% of the guaranteed maximum capacitance) at +25, -55°C and either $+85^{\circ}\text{C}$ or $+125^{\circ}\text{C}$, whichever is applicable to the respective style, at a frequency of 0.1 to 1 Megahertz. Each measurement shall be made after the capacitor has reached thermal stability.

CAPACITANCE DRIFT: The capacitance drift shall be determined as the greatest difference between any two of the three 25°C measurements obtained during the temperature characteristic test. The capacitance drift shall not exceed 0.75% or 0.5pF, whichever is greater.

ACCELERATED LIFE TEST: The capacitor, at approximately 75% of the guaranteed maximum capacitance, shall be tested for 250 hours at twice rated voltage, and at a temperature equal to the maximum operating temperature $\pm 3^{\circ}\text{C}$ for the respective style. At the end of this period the capacitance shall not have changed more than $\pm 5\%$ or $\pm 0.5\text{pF}$, whichever is greater, from its value before the life test. The I.R. shall be 1 gigaohm minimum and the “Q” at 1 MHz shall be a minimum of 40% of the initial test limit.

TEMPERATURE CYCLING & HUMIDITY: The capacitor at approximately 75% of the guaranteed maximum capacitance, shall be given a treatment consisting of 5 temperature cycles as follows: Cool the capacitors to $-55^{\circ}\text{C} \pm 3^{\circ}\text{C}$. Remove the capacitor from the cooling chamber and allow to reach room temp.

Then place in an oven at a temperature equal to maximum operating temperature $\pm 3^{\circ}\text{C}$ of the respective style. Remove from oven and allow capacitor to cool to room temperature. The capacitor shall be held at the specified minimum and maximum temperatures long enough to reach equilibrium and in no case less than 15 minutes. The rate of change of temperature in cooling from room temperature, or heating above it shall not be less than 3°C per minute.

The temperature cycles shall be followed by exposures for 96 hours to a relative humidity of 95% at $40^{\circ}\text{C} \pm 3^{\circ}\text{C}$. The capacitor shall then be removed from the humidity chamber and held at $25^{\circ}\text{C} \pm 5^{\circ}\text{C}$ with a maximum humidity of 50% for four hours. The I.R. shall be at least 1 gigaohm, the “Q” at 1 MHz is at least 40% of initial test limit and the capacitance shall not have changed by more than $\pm 3\%$ or $\pm 0.5\text{pF}$, whichever is greater, from its value prior to the start of the temperature cycling.

Dielectric Type Code	Percent Capacitance Change From Value @ 25°C					
	-55°C		$+85^{\circ}\text{C}$		$+125^{\circ}\text{C}$	
	Min.	Max.	Min.	Max.	Min.	Max.
P/N 518, 528, 538						
A	-4.5	+2.0	-2.5	+2.0	-4.2	+3.4
B	-1.0	+3.5	-2.5	-0.5	-4.2	-0.8
C	-1.0	+6.5	-4.0	-1.0	-6.7	-1.7
D	+1.5	+8.2	-5.0	-1.5	-8.5	-2.5
F	+3.0	+14.0	-10.0	-3.0	-17.0	-5.0
P/N 513						
A	-2.1	+4.2	-3.8	+1.1	-	-
F	0.0	+14.0	-8.0	-3.0	-	-

TUSONIX on-line: www.tusonix.com

The TUSONIX Web Site provides visitors with a wide range of product and ordering information. At www.tusonix.com, customers can view product information, download catalogs and product data sheets in Adobe Acrobat® .pdf format, as well as view or link to Sales Offices, International Agents and Distributors. We also offer Stock Check and Cross Reference features for our customers' convenience. An on-line request form allows customers to immediately specify product requirements and request information or samples. TUSONIX continually strives to improve and enhance its web site in accordance with its customers' needs.

Mouser Electronics

Authorized Distributor

Click to View Pricing, Inventory, Delivery & Lifecycle Information:

Tusonix:

[518-002 A 2.0-5](#) [518-033 A 1.5](#) [518-033 A 1.0-6](#) [518-000 A 5-25](#) [538-011 D 9-35LF](#) [0528-000-F-3.5-17LF](#) [0538-002-A-5.5-18LF](#) [0538-006-B-2.5-11LF](#) [0538-006-C-8.0-25LF](#) [0528-002-F-6.0-22LF](#) [0538-002-C-3.0-10LF](#) [0528-002-A-2.0-5LF](#) [0518-000-A-5.0-30LF](#) [0518-002-A-2.0-5LF](#) [0518-002-A-3.5-20LF](#) [0518-000-A-2.0-5LF](#) [0528-000-A-1.0-3LF](#) [0538-000-B-2.5-11LF](#) [0518-002-A-5.0-15LF](#) [0518-000-A-5.0-15LF](#) [0528-000-F-6.0-22LF](#) [0538-000-A-2.0-8LF](#) [0538-000-B-7.0-25LF](#) [0538-002-C-8.0-25LF](#) [0538-006-D-3.0-15LF](#) [0518-002-A-6.0-22LF](#) [0528-000-A-4.0-14LF](#) [0518-002-A-5.0-30LF](#) [0528-002-A-3.0-8LF](#) [0538-000-D-9.0-35LF](#) [0518-002-C-7.0-40LF](#) [0538-002-F-15.0-60LF](#) [0528-000-A-3.0-8LF](#) [0518-000-A-6.0-22LF](#) [0538-006-D-9.0-35LF](#) [0528-002-C-3.5-10LF](#) [0518-000-A-5.0-25LF](#) [0518-002-A-5.0-25LF](#) [0528-000-C-3.5-10LF](#) [0518-002-A-2.5-9LF](#) [0538-006-A-5.5-18LF](#) [0538-011-C-8.0-25LF](#) [0538-000-C-3.0-10LF](#) [0538-006-B-7.0-25LF](#) [0538-000-F-15.0-60LF](#) [0538-006-A-2.0-8LF](#) [0538-002-D-3.0-15LF](#) [0518-000-A-1.0-3LF](#) [0518-000-A-3.0-9LF](#) [0528-002-A-4.0-14LF](#) [0538-011-B-2.5-11LF](#) [0538-011-C-3.0-10LF](#) [0528-000-A-3.5-10LF](#) [0518-002-A-3.0-9LF](#) [0538-002-B-7.0-25LF](#) [0538-006-C-3.0-10LF](#) [0538-000-A-5.5-18LF](#) [0528-002-F-3.5-17LF](#) [0528-002-A-1.0-3LF](#) [0538-002-B-2.5-11LF](#) [0538-011-A-2.0-8LF](#) [0528-002-A-3.5-10LF](#) [0528-002-E-4.5-15LF](#) [0518-002-A-1.25-3LF](#)

Данный компонент на территории Российской Федерации

Вы можете приобрести в компании MosChip.

Для оперативного оформления запроса Вам необходимо перейти по данной ссылке:

<http://moschip.ru/get-element>

Вы можете разместить у нас заказ для любого Вашего проекта, будь то серийное производство или разработка единичного прибора.

В нашем ассортименте представлены ведущие мировые производители активных и пассивных электронных компонентов.

Нашей специализацией является поставка электронной компонентной базы двойного назначения, продукции таких производителей как XILINX, Intel (ex.ALTERA), Vicor, Microchip, Texas Instruments, Analog Devices, Mini-Circuits, Amphenol, Glenair.

Сотрудничество с глобальными дистрибьюторами электронных компонентов, предоставляет возможность заказывать и получать с международных складов практически любой перечень компонентов в оптимальные для Вас сроки.

На всех этапах разработки и производства наши партнеры могут получить квалифицированную поддержку опытных инженеров.

Система менеджмента качества компании отвечает требованиям в соответствии с ГОСТ Р ИСО 9001, ГОСТ РВ 0015-002 и ЭС РД 009

Офис по работе с юридическими лицами:

105318, г.Москва, ул.Щербаковская д.3, офис 1107, 1118, ДЦ «Щербаковский»

Телефон: +7 495 668-12-70 (многоканальный)

Факс: +7 495 668-12-70 (доб.304)

E-mail: info@moschip.ru

Skype отдела продаж:

moschip.ru

moschip.ru_4

moschip.ru_6

moschip.ru_9