

# JSM Series Sub-Miniature Slide Switches

## Features/Benefits

- RoHS compliant and meets all requirements of RoHS directive 2002/95EC, Halogen Free
- Positive detent
- Low profile
- IR reflow to 260° solder profile
- Surface and thru hole mounting
- Maintained and momentary functions
- SPDT, SP3T models

## Typical Applications

- Telecommunication products
- Computer peripherals
- Thermostat select switch
- Instrumentations

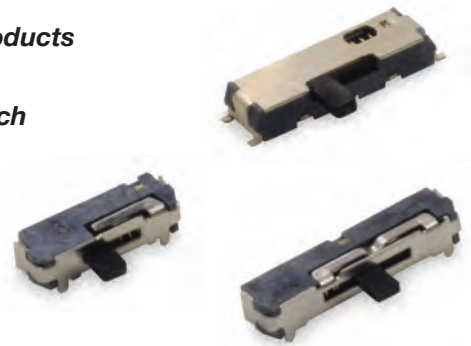

## Specifications

CONTACT RATING: 4 VDC @ 0.3A  
 ELECTRICAL LIFE: 10,000 make-and-break cycles at full load.  
 CONTACT RESISTANCE: 70 m Ω max.  
 INSULATION RESISTANCE: 100 M Ω min. @ 500V.  
 DIELECTRIC STRENGTH: 100 VAC min. @ sea level.  
 OPERATING TEMPERATURE: -10°C to +60°C  
 STORAGE TEMPERATURE: -30°C to +85°C

**NOTE:** Specifications and materials listed above are for switches with standard options.  
 For information on specific and custom switches, consult Customer Service Center.

## Materials

HOUSING: LCP, Glass filled (Halogen free)  
 ACTUATOR: 4/6 nylon (UL94V-2), black.  
 CONTACTS: Beryllium copper, silver plated.  
 TERMINALS: Brass, silver plated.  
 COVER: Stainless steel  
 RETURN SPRING: Stainless steel

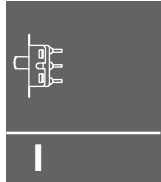

Slide

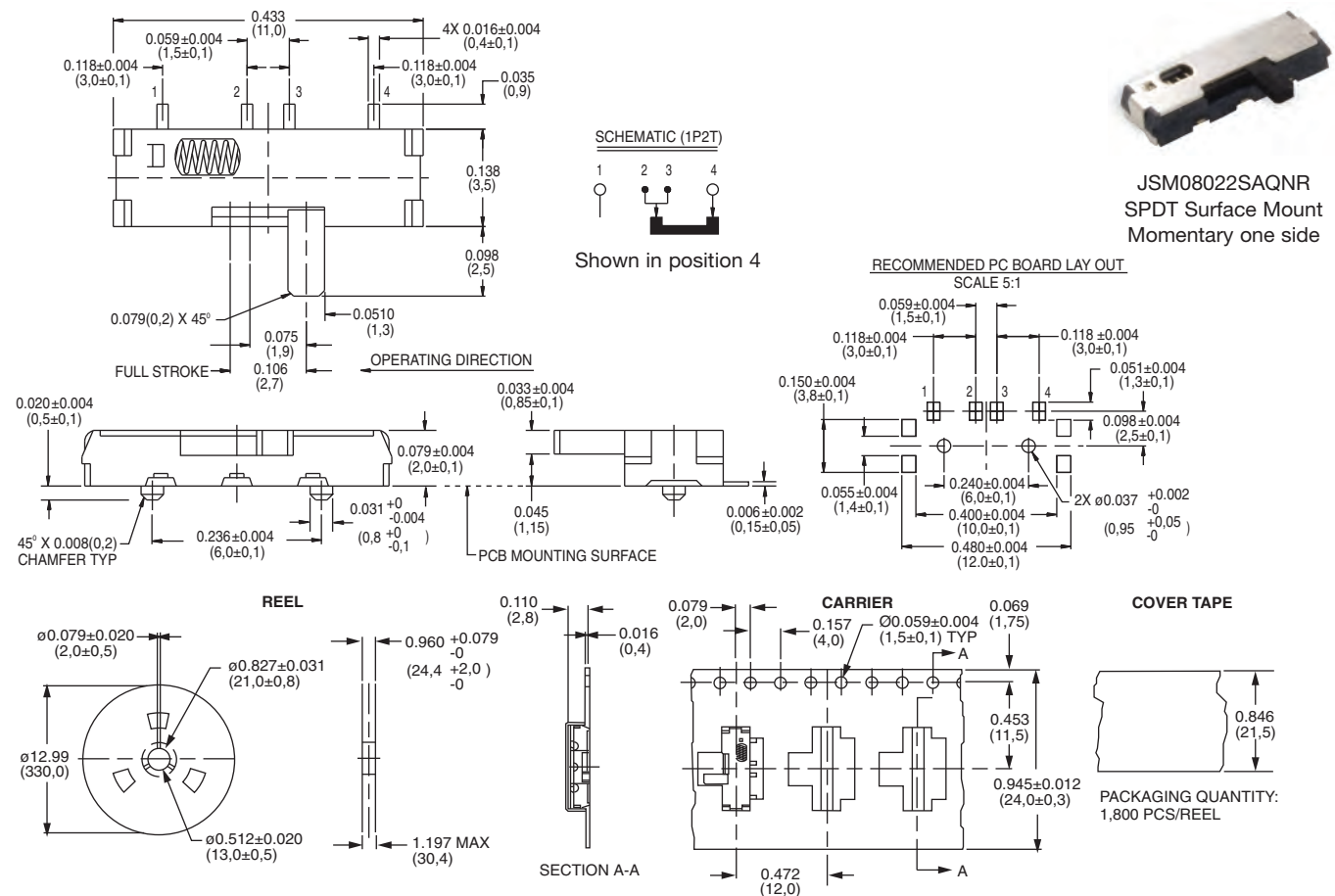

Third Angle  
 Projection  
 Dimensions are shown: Inches (mm)  
 Specifications and dimensions subject to change

# JSM Series Sub-Miniature Slide Switches

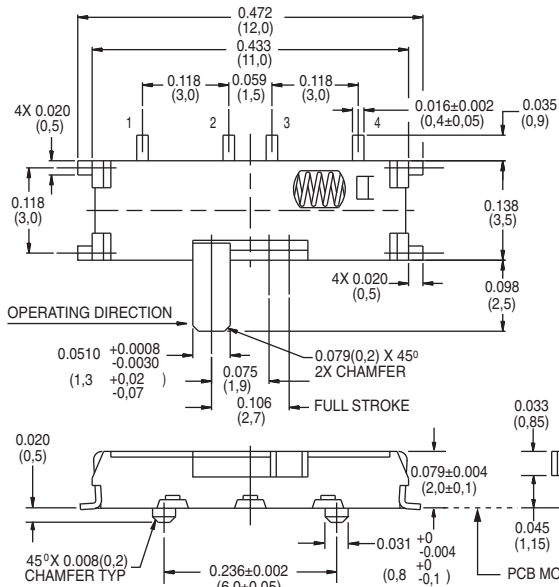

**SCHEMATIC (1P2T)**

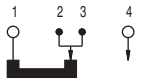

Shown in position 1



**JSM08022SAQNL**  
SPDT Surface Mount  
Momentary only

**RECOMMENDED PC BOARD LAY OUT**

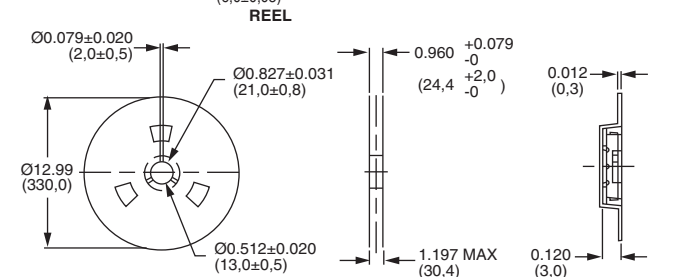
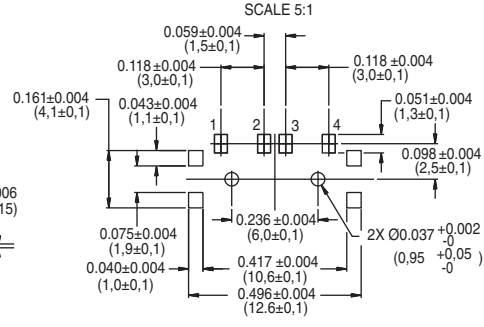

**CARRIER TAPE**

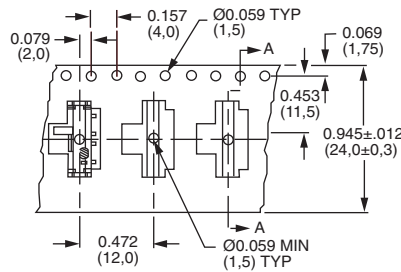

**COVER TAPE**

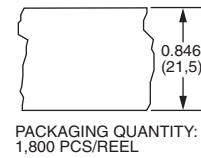

PACKAGING QUANTITY:  
1,800 PCS/REEL

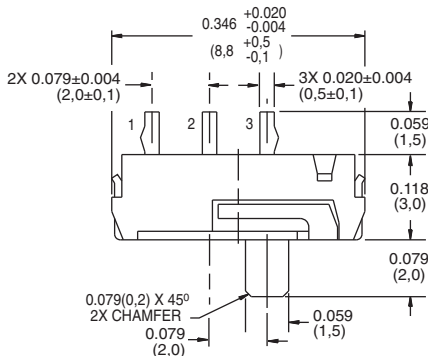

**SCHEMATIC (1P2T)**

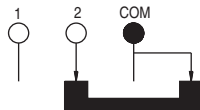

Shown in position 2



**JSM08011SAQNR**  
SPDT Surface Mount  
Momentary only

**RECOMMENDED PC BOARD LAY OUT**

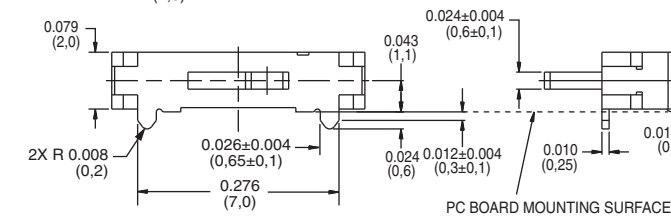
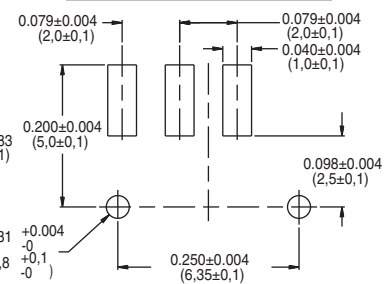

PC BOARD MOUNTING SURFACE

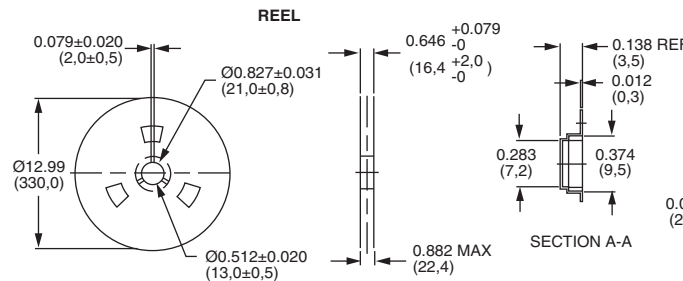

**CARRIER TAPE**

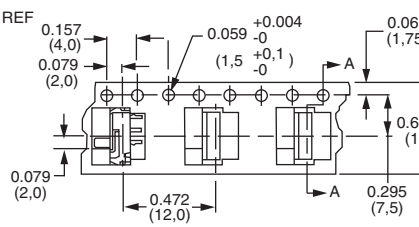

**COVER TAPE**



PACKAGING QUANTITY:  
1,800 PCS/REEL



Third Angle  
Projection  
Dimensions are shown: Inch (mm)  
Specifications and dimensions subject to change



# JSM Series Sub-Miniature Slide Switches

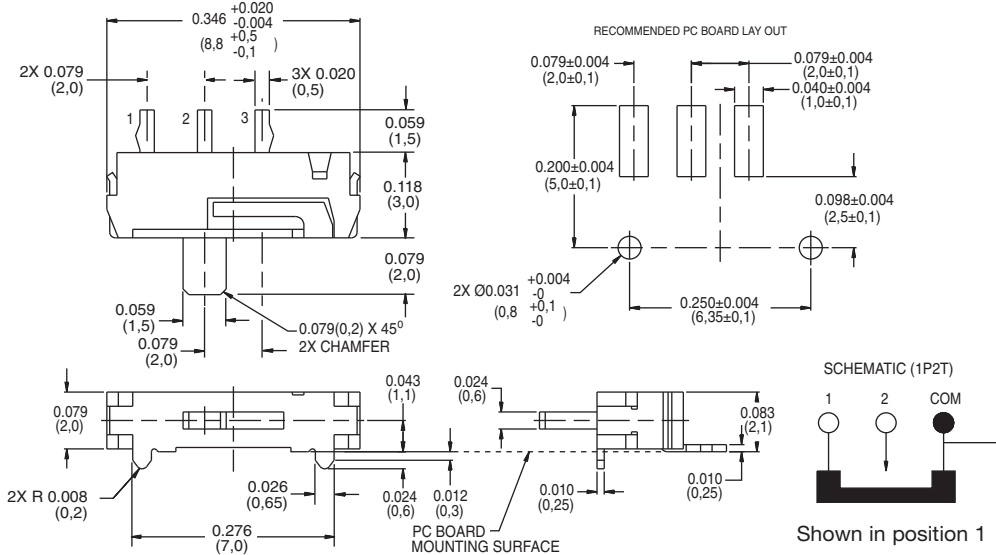

JSM08011SAQNL  
SPDT Surface Mount  
Momentary only

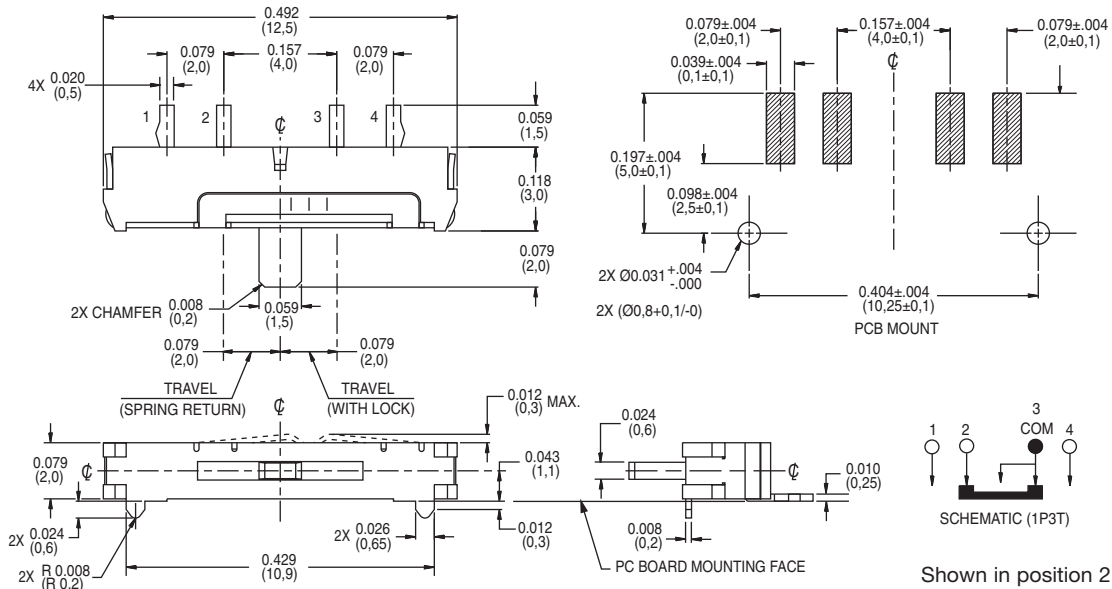
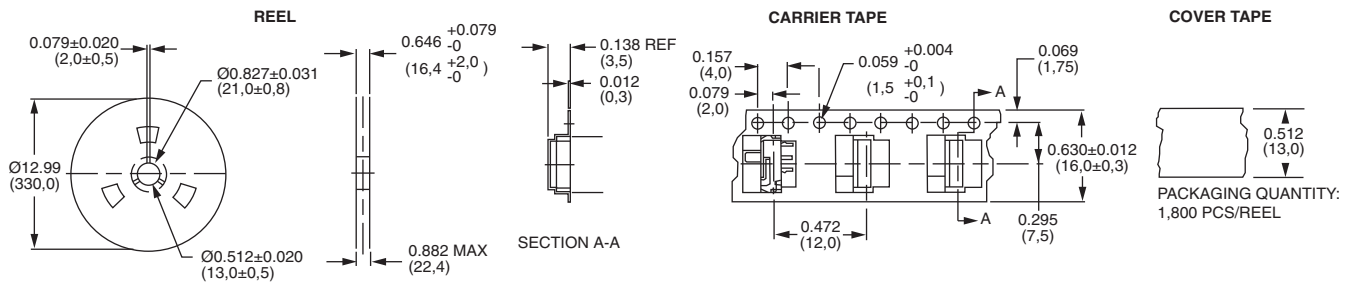
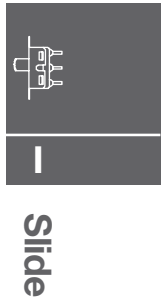

JSM07011SAQNR  
SP3T Surface Mount  
Momentary one side  
& Maintained the other



Dimensions are shown: Inches (mm)  
Specifications and dimensions subject to change

# JSM Series Sub-Miniature Slide Switches

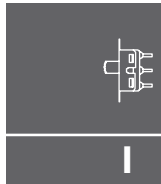

Slide

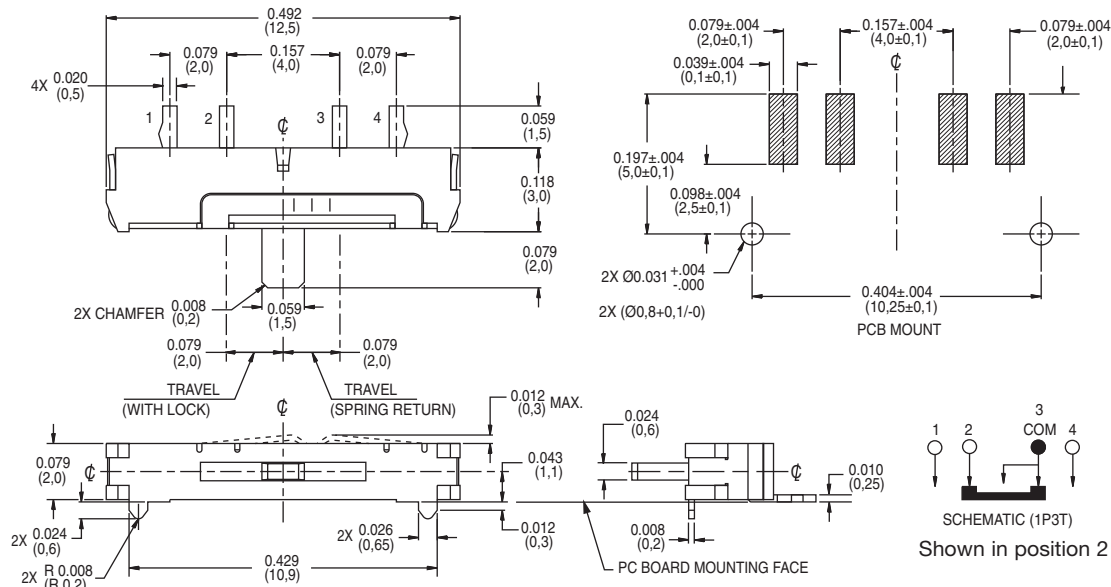

JSM07011SAQNL  
SP3T Surface Mount  
Momentary one side  
& Maintained the other

Packaging for JSM07011SAQNR and JSM07011SAQNL

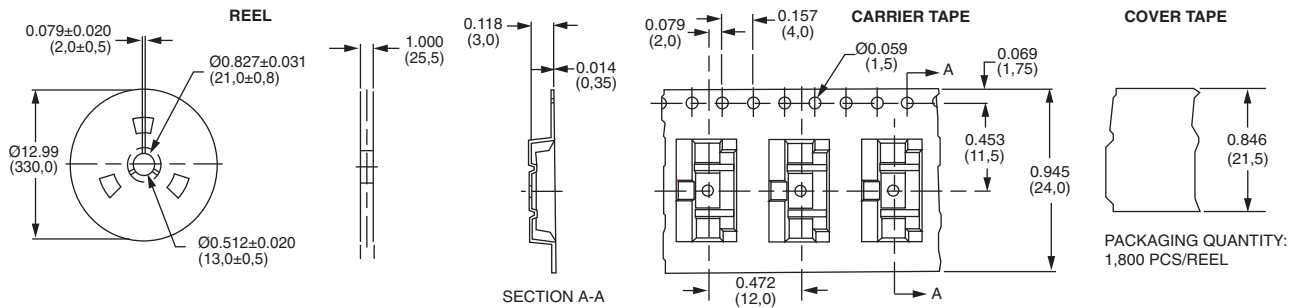

Dimensions are shown: Inch (mm)  
Specifications and dimensions subject to change

# JSM Series Sub-Miniature Slide Switches

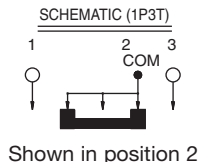
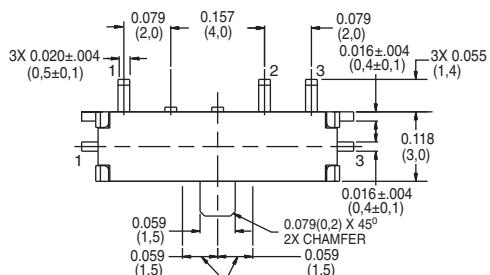

JSM05000SAQN  
SP3T Surface Mount  
Momentary both  
sides

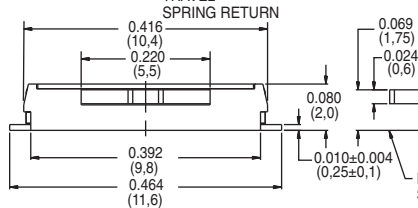

RECOMMENDED PC BOARD LAY OUT  
SCALE 5:1

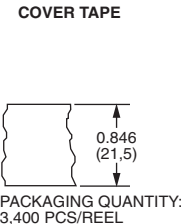
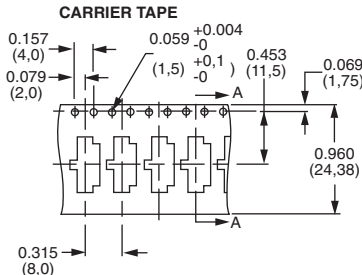
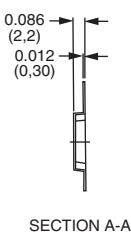
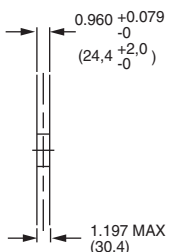
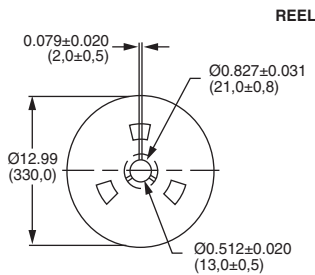
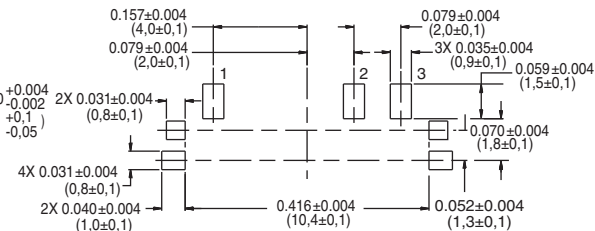

PACKAGING QUANTITY:  
3,400 PCS/REEL



Third Angle  
Projection  
Dimensions are shown: Inches (mm)  
Specifications and dimensions subject to change

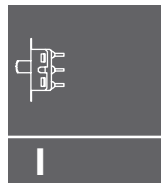

Side

## Данный компонент на территории Российской Федерации

### Вы можете приобрести в компании MosChip.

Для оперативного оформления запроса Вам необходимо перейти по данной ссылке:

<http://moschip.ru/get-element>

Вы можете разместить у нас заказ для любого Вашего проекта, будь то серийное производство или разработка единичного прибора.

В нашем ассортименте представлены ведущие мировые производители активных и пассивных электронных компонентов.

Нашей специализацией является поставка электронной компонентной базы двойного назначения, продукции таких производителей как XILINX, Intel (ex.ALTERA), Vicor, Microchip, Texas Instruments, Analog Devices, Mini-Circuits, Amphenol, Glenair.

Сотрудничество с глобальными дистрибьюторами электронных компонентов, предоставляет возможность заказывать и получать с международных складов практически любой перечень компонентов в оптимальные для Вас сроки.

На всех этапах разработки и производства наши партнеры могут получить квалифицированную поддержку опытных инженеров.

Система менеджмента качества компании отвечает требованиям в соответствии с ГОСТ Р ИСО 9001, ГОСТ РВ 0015-002 и ЭС РД 009

### Офис по работе с юридическими лицами:

105318, г.Москва, ул.Щербаковская д.3, офис 1107, 1118, ДЦ «Щербаковский»

Телефон: +7 495 668-12-70 (многоканальный)

Факс: +7 495 668-12-70 (доб.304)

E-mail: [info@moschip.ru](mailto:info@moschip.ru)

Skype отдела продаж:

moschip.ru

moschip.ru\_4

moschip.ru\_6

moschip.ru\_9