

Pushbutton Switch A16

Mounting Aperture of 16 mm

- Modular construction (Pushbutton + Case + Lamp + Switch)
- Wide Variety of Control and Signal Devices: Lighted, Non-Lighted, and Buzzer
- UL and cUL approved.
- Conforms to EN60947-5-1, IEC947-5-1
- Quick and easy assembly, snap-in Switch.
- Wide range of switching capacity from standard to microload
- High reliability, IP65
- Short mounting depth, less than 28.5 mm below panel



Model Number Structure

Model Number Legend

Completely Assembled

The model numbers used to order sets of Units are illustrated below. One set comprises the Pushbutton, Lamp (lighted models only), Case, and Switch.

A 1 6 5 L - J R M - 24D - 2

(1) Degree of Protection

| Symbol | Protection |
|-----------|--------------------|
| No symbol | IP40 |
| 5 | IP65 oil-resistant |

(2) Lighted/Non-lighted

| Symbol | Type |
|-----------|-------------|
| No symbol | Non-lighted |
| L | Lighted |

(3) Shape of Pushbutton

| Symbol | Shape |
|--------|-------------------------|
| J | Rectangular 2-way guard |
| A | Square 2-way guard |
| T | Round Projecting model |
| 3J | Rectangular 3-way guard |
| BA | Square 24-mm square |

(4) Color of Pushbutton

| Symbol | Color |
|--------|---------------------------------|
| R | Red |
| Y | Yellow |
| PY | Pure yellow |
| G | Green |
| W | White |
| A | Blue |
| B | Black (non-lighted models only) |

"Colored-illumination" models operate in the way shown below:

| Unlit | Lit |
|-------|-------|
| White | Color |

The built-in LED is colored.

(5) Switch Operation

| Symbol | Operation |
|--------|-----------|
| M | Momentary |
| A | Alternate |

Momentary-action: Self-resetting
Alternate-action: Self-holding

(6) Light Source

| Symbol | Type | Operating voltage | Rated voltage |
|-----------|-------------------|-------------------|---------------|
| No symbol | Non-lighted | | |
| 5 | Incandescent lamp | 5 VAC/VDC | 6 VAC/VDC |
| 12 | | 12 VAC/VDC | 14 VAC/VDC |
| 24 | | 24 VAC/VDC | 28 VAC/VDC |
| 5D | LED | 5 ±5% VDC | 5 VDC |
| 12D | | 12 ±5% VDC | 12 VDC |
| 24D | | 24 ±5% VDC | 24 VDC |

Voltage Reduction Unit (24-V Built-in LED)

| Symbol | Type | Operating voltage | Rated voltage |
|--------|------|--------------------|---------------|
| T1 | LED | 90 to 121 VAC/VDC | 110 VAC |
| T2 | | 180 to 242 VAC/VDC | 220 VAC |

(7) Contact Configuration

| Symbol | Type | Terminal |
|--------|------|------------------|
| 1 | SPDT | Solder Terminal |
| 2 | DPDT | Solder Terminal |
| 1P | SPDT | PCB Terminal |
| 2P | DPDT | PCB Terminal |
| 2S | DPDT | Screw-Less Clamp |







Only DPDT contacts are available with Screw-Less Clamp.

Note:

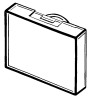
1. Solder terminals are available only with 100-V models.
2. The Voltage Reduction Unit is not available for models with PCB terminals.

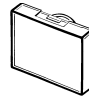
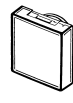
Pushbutton Switches

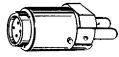
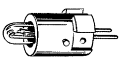
Neon lamps are not available with models that are ordered as a set. They must be ordered individually if required. Refer to page 13.

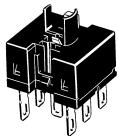
| Model | Lighted Pushbutton Switches | Non-lighted Pushbutton Switches |
|------------|---|---|
| Pushbutton | <p>Rectangular </p> <p>Square </p> <p>Round </p> | <p>Rectangular </p> <p>Square </p> <p>Round </p> |
| Lamp | <p>LED lamp  Incandescent lamp  Neon lamp </p> | |
| Case |  | |
| Switch | <p>Solder Terminals (Without Voltage Reduction Unit)</p>  | |

Note: There is no Lamp with non-lighted models.

Subassembled

1. Pushbutton

Non-lighted/Lighted

A16 L-
 1 2 3

1. Degree of Protection

None: IP40

5: IP65

2. Flange Shape

J: Rectangular

T: Round

A: Square

3. Illumination Color for Non-lighted Models

R: Red

G: Green

Y: Yellow

W: White

A: Blue

B: Black

Illumination Color for Lighted Models

LED/Incandescent Lamp

R: Red

Y: Yellow

PY: Pure yellow

W: White

A: Blue

LED

GY: Green

Incandescent Lamp

G: Green

Neon Lamp

RN: Red

GN: Green

2. Lamp

A16-□□
1 2

1. Operating Voltage (Rated Voltage)

Incandescent Lamp

- 5: 5 VAC/VDC (6 VAC/VDC)
- 12: 12 VAC/VDC (14 VAC/VDC)
- 24: 24 VAC/VDC (28 VAC/VDC)

LED

- 5DS: 5 VDC (5 VDC)
- 12DS: 12 VDC (12 VDC)
- 24DS: 24 VDC (24 VDC)

Neon Lamp

- 1N: 100 VAC (110 VAC)
- 2N: 200 VAC (220 VAC)

2. Illumination Color

- None: Incandescent Lamp
- R: Red (LED)
- G: Green (LED)
- Y: Yellow (LED)
- W: White (LED)
- A: Blue (LED)
- RN: Red (Neon Lamp)
- GN: Green (Neon Lamp)

3. Case

A16□-□□□
1 2 3

1. Degree of Protection

- None: IP40
- 5: IP65 Oil-resistant

2. Flange Shape

- CJ: Rectangular
- CT: Round
- CA: Square

3. Switch Action

- M: Momentary
- A: Alternate

4. Switch (Solder Terminals)

A16-□-□
1 2

1. Voltage Reduction Circuit

(Operating Voltage/Rated Voltage)

- None: Without Voltage Reduction Unit
- T1: 100 VAC/110 VAC

2. Contacts

- 1: SPDT
- 2: DPDT

5. Socket (Solder Terminals Only)

M16-□
1

1. Voltage Reduction Circuit

(Operating Voltage/Rated Voltage)

- 0: Without Voltage Reduction Unit
- T1: 100 VAC/110 VAC

Ordering Information

List of Models

Ordering as a Set

The model numbers used to order sets of Units are given in the following tables. One set comprises the Pushbutton, Lamp (lighted models only), Case, and Switch.

A16□-J (Rectangular) Models

Solder Terminal Models

IP40

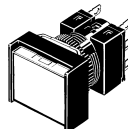

| Output | Lighting | Operating voltage | Momentary operation (Self-resetting) | Alternate operation (Self-holding) | Pushbutton color symbol (See note 1.) | | | |
|-------------------|------------------------------------|------------------------------------|--------------------------------------|------------------------------------|---|---|----------------|---|
| SPDT | LED without Voltage Reduction Unit | 5 VDC | A16L-J□M-5D-1 | A16L-J□A-5D-1 | R: red Y: yellow PY: pure yellow G: green A: blue W: white | | | |
| | | 12 VDC | A16L-J□M-12D-1 | A16L-J□A-12D-1 | | | | |
| | | 24 VDC | A16L-J□M-24D-1 | A16L-J□A-24D-1 | | | | |
| | Incandescent lamp | 5 VDC/VAC | A16L-J□M-5-1 | A16L-J□A-5-1 | | R: red Y: yellow PY: pure yellow G: green W: white A: blue B: black (See note 2.) | | |
| | | 12 VDC/VAC | A16L-J□M-12-1 | A16L-J□A-12-1 | | | | |
| | | 24 VDC/VAC | A16L-J□M-24-1 | A16L-J□A-24-1 | | | | |
| | Non-lighted | | | A16-J□M-1 | | | A16-J□A-1 | |
| | DPDT | LED without Voltage Reduction Unit | 5 VDC | A16L-J□M-5D-2 | | | A16L-J□A-5D-2 | R: red Y: yellow PY: pure yellow G: green A: blue W: white |
| | | | 12 VDC | A16L-J□M-12D-2 | | | A16L-J□A-12D-2 | |
| 24 VDC | | | A16L-J□M-24D-2 | A16L-J□A-24D-2 | | | | |
| Incandescent lamp | | 5 VDC/VAC | A16L-J□M-5-2 | A16L-J□A-5-2 | R: red Y: yellow PY: pure yellow G: green W: white A: blue B: black (See note 2.) | | | |
| | | 12 VDC/VAC | A16L-J□M-12-2 | A16L-J□A-12-2 | | | | |
| | | 24 VDC/VAC | A16L-J□M-24-2 | A16L-J□A-24-2 | | | | |
| Non-lighted | | | A16-J□M-2 | A16-J□A-2 | | | | |

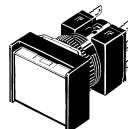

IP65 Oil-resistant

| Output | Lighting | Operating voltage | Momentary operation (Self-resetting) | Alternate operation (Self-holding) | Pushbutton color symbol (See note 1.) | | | |
|-------------------|------------------------------------|------------------------------------|--------------------------------------|------------------------------------|---|---|-----------------|---|
| SPDT | LED without Voltage Reduction Unit | 5 VDC | A165L-J□M-5D-1 | A165L-J□A-5D-1 | R: red Y: yellow PY: pure yellow G: green A: blue W: white | | | |
| | | 12 VDC | A165L-J□M-12D-1 | A165L-J□A-12D-1 | | | | |
| | | 24 VDC | A165L-J□M-24D-1 | A165L-J□A-24D-1 | | | | |
| | Incandescent lamp | 5 VDC/VAC | A165L-J□M-5-1 | A165L-J□A-5-1 | | R: red Y: yellow PY: pure yellow G: green W: white A: blue B: black (See note 2.) | | |
| | | 12 VDC/VAC | A165L-J□M-12-1 | A165L-J□A-12-1 | | | | |
| | | 24 VDC/VAC | A165L-J□M-24-1 | A165L-J□A-24-1 | | | | |
| | Non-lighted | | | A165-J□M-1 | | | A165-J□A-1 | |
| | DPDT | LED without Voltage Reduction Unit | 5 VDC | A165L-J□M-5D-2 | | | A165L-J□A-5D-2 | R: red Y: yellow PY: pure yellow G: green A: blue W: white |
| | | | 12 VDC | A165L-J□M-12D-2 | | | A165L-J□A-12D-2 | |
| 24 VDC | | | A165L-J□M-24D-2 | A165L-J□A-24D-2 | | | | |
| Incandescent lamp | | 5 VDC/VAC | A165L-J□M-5-2 | A165L-J□A-5-2 | R: red Y: yellow PY: pure yellow G: green W: white A: blue B: black (See note 2.) | | | |
| | | 12 VDC/VAC | A165L-J□M-12-2 | A165L-J□A-12-2 | | | | |
| | | 24 VDC/VAC | A165L-J□M-24-2 | A165L-J□A-24-2 | | | | |
| Non-lighted | | | A165-J□M-2 | A165-J□A-2 | | | | |

Note: 1. Enter the desired color symbol for the Pushbutton in the □.

2. Black ("B") Pushbuttons are only available for non-lighted models.

A16□-A (Square) Models

Solder Terminal Models

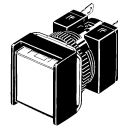

IP40

| Output | Lighting | Operating voltage | Momentary operation (Self-resetting) | Alternate operation (Self-holding) | Pushbutton color symbol (See note 1.) | | | |
|-------------------|------------------------------------|------------------------------------|--------------------------------------|------------------------------------|---|---|----------------|---|
| SPDT | LED without Voltage Reduction Unit | 5 VDC | A16L-A□M-5D-1 | A16L-A□A-5D-1 | R: red Y: yellow PY: pure yellow G: green A: blue W: white | | | |
| | | 12 VDC | A16L-A□M-12D-1 | A16L-A□A-12D-1 | | | | |
| | | 24 VDC | A16L-A□M-24D-1 | A16L-A□A-24D-1 | | | | |
| | Incandescent lamp | 5 VDC/VAC | A16L-A□M-5-1 | A16L-A□A-5-1 | | R: red Y: yellow PY: pure yellow G: green W: white A: blue B: black (See note 2.) | | |
| | | 12 VDC/VAC | A16L-A□M-12-1 | A16L-A□A-12-1 | | | | |
| | | 24 VDC/VAC | A16L-A□M-24-1 | A16L-A□A-24-1 | | | | |
| | Non-lighted | | A16-A□M-1 | A16-A□A-1 | | | | |
| | DPDT | LED without Voltage Reduction Unit | 5 VDC | A16L-A□M-5D-2 | | | A16L-A□A-5D-2 | R: red Y: yellow PY: pure yellow G: green A: blue W: white |
| | | | 12 VDC | A16L-A□M-12D-2 | | | A16L-A□A-12D-2 | |
| 24 VDC | | | A16L-A□M-24D-2 | A16L-A□A-24D-2 | | | | |
| Incandescent lamp | | 5 VDC/VAC | A16L-A□M-5-2 | A16L-A□A-5-2 | R: red Y: yellow PY: pure yellow G: green W: white A: blue B: black (See note 2.) | | | |
| | | 12 VDC/VAC | A16L-A□M-12-2 | A16L-A□A-12-2 | | | | |
| | | 24 VDC/VAC | A16L-A□M-24-2 | A16L-A□A-24-2 | | | | |
| Non-lighted | | A16-A□M-2 | A16-A□A-2 | | | | | |

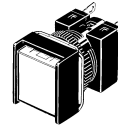

IP65 Oil-resistant

| Output | Lighting | Operating voltage | Momentary operation (Self-resetting) | Alternate operation (Self-holding) | Pushbutton color symbol (See note 1.) | | | |
|-------------------|------------------------------------|------------------------------------|--------------------------------------|------------------------------------|---|---|-----------------|---|
| SPDT | LED without Voltage Reduction Unit | 5 VDC | A165L-A□M-5D-1 | A165L-A□A-5D-1 | R: red Y: yellow PY: pure yellow G: green A: blue W: white | | | |
| | | 12 VDC | A165L-A□M-12D-1 | A165L-A□A-12D-1 | | | | |
| | | 24 VDC | A165L-A□M-24D-1 | A165L-A□A-24D-1 | | | | |
| | Incandescent lamp | 5 VDC/VAC | A165L-A□M-5-1 | A165L-A□A-5-1 | | R: red Y: yellow PY: pure yellow G: green W: white A: blue B: black (See note 2.) | | |
| | | 12 VDC/VAC | A165L-A□M-12-1 | A165L-A□A-12-1 | | | | |
| | | 24 VDC/VAC | A165L-A□M-24-1 | A165L-A□A-24-1 | | | | |
| | Non-lighted | | A165-A□M-1 | A165-A□A-1 | | | | |
| | DPDT | LED without Voltage Reduction Unit | 5 VDC | A165L-A□M-5D-2 | | | A165L-A□A-5D-2 | R: red Y: yellow PY: pure yellow G: green A: blue W: white |
| | | | 12 VDC | A165L-A□M-12D-2 | | | A165L-A□A-12D-2 | |
| 24 VDC | | | A165L-A□M-24D-2 | A165L-A□A-24D-2 | | | | |
| Incandescent lamp | | 5 VDC/VAC | A165L-A□M-5-2 | A165L-A□A-5-2 | R: red Y: yellow PY: pure yellow G: green W: white A: blue B: black (See note 2.) | | | |
| | | 12 VDC/VAC | A165L-A□M-12-2 | A165L-A□A-12-2 | | | | |
| | | 24 VDC/VAC | A165L-A□M-24-2 | A165L-A□A-24-2 | | | | |
| Non-lighted | | A165-A□M-2 | A165-A□A-2 | | | | | |

- Note:**
1. Enter the desired color symbol for the Pushbutton in the □.
 2. Black ("B") Pushbuttons are only available for non-lighted models.

A16□-T (Round) Models

Solder Terminals



IP40

| Output | Lighting | Operating voltage | Momentary operation (Self-resetting) | Alternate operation (Self-holding) | Pushbutton color symbol (See note 1.) | |
|-------------------|------------------------------------|------------------------------------|--------------------------------------|------------------------------------|---|---|
| SPDT | LED without Voltage Reduction Unit | 5 VDC | A16L-T□M-5D-1 | A16L-T□A-5D-1 | R: red Y: yellow PY: pure yellow G: green A: blue W: white | |
| | | 12 VDC | A16L-T□M-12D-1 | A16L-T□A-12D-1 | | |
| | | 24 VDC | A16L-T□M-24D-1 | A16L-T□A-24D-1 | | |
| | Incandescent lamp | 5 VDC/VAC | A16L-T□M-5-1 | A16L-T□A-5-1 | R: red Y: yellow PY: pure yellow G: green W: white A: blue B: black (See note 2.) | |
| | | 12 VDC/VAC | A16L-T□M-12-1 | A16L-T□A-12-1 | | |
| | | 24 VDC/VAC | A16L-T□M-24-1 | A16L-T□A-24-1 | | |
| | Non-lighted | | | A16-T□M-1 | A16-T□A-1 | |
| | DPDT | LED without Voltage Reduction Unit | 5 VDC | A16L-T□M-5D-2 | A16L-T□A-5D-2 | R: red Y: yellow PY: pure yellow G: green A: blue W: white |
| | | | 12 VDC | A16L-T□M-12D-2 | A16L-T□A-12D-2 | |
| 24 VDC | | | A16L-T□M-24D-2 | A16L-T□A-24D-2 | | |
| Incandescent lamp | | 5 VDC/VAC | A16L-T□M-5-2 | A16L-T□A-5-2 | R: red Y: yellow PY: pure yellow G: green W: white A: blue B: black (See note 2.) | |
| | | 12 VDC/VAC | A16L-T□M-12-2 | A16L-T□A-12-2 | | |
| | | 24 VDC/VAC | A16L-T□M-24-2 | A16L-T□A-24-2 | | |
| Non-lighted | | | A16-T□M-2 | A16-T□A-2 | | |



IP65 Oil-resistant

| Output | Lighting | Operating voltage | Momentary operation (Self-resetting) | Alternate operation (Self-holding) | Pushbutton color symbol (See note 1.) | |
|-------------------|------------------------------------|------------------------------------|--------------------------------------|------------------------------------|---|---|
| SPDT | LED without Voltage Reduction Unit | 5 VDC | A165L-T□M-5D-1 | A165L-T□A-5D-1 | R: red Y: yellow PY: pure yellow G: green A: blue W: white | |
| | | 12 VDC | A165L-T□M-12D-1 | A165L-T□A-12D-1 | | |
| | | 24 VDC | A165L-T□M-24D-1 | A165L-T□A-24D-1 | | |
| | Incandescent lamp | 5 VDC/VAC | A165L-T□M-5-1 | A165L-T□A-5-1 | R: red Y: yellow PY: pure yellow G: green W: white A: blue B: black (See note 2.) | |
| | | 12 VDC/VAC | A165L-T□M-12-1 | A165L-T□A-12-1 | | |
| | | 24 VDC/VAC | A165L-T□M-24-1 | A165L-T□A-24-1 | | |
| | Non-lighted | | | A165-T□M-1 | A165-T□A-1 | |
| | DPDT | LED without Voltage Reduction Unit | 5 VDC | A165L-T□M-5D-2 | A165L-T□A-5D-2 | R: red Y: yellow PY: pure yellow G: green A: blue W: white |
| | | | 12 VDC | A165L-T□M-12D-2 | A165L-T□A-12D-2 | |
| 24 VDC | | | A165L-T□M-24D-2 | A165L-T□A-24D-2 | | |
| Incandescent lamp | | 5 VDC/VAC | A165L-T□M-5-2 | A165L-T□A-5-2 | R: red Y: yellow PY: pure yellow G: green W: white A: blue B: black (See note 2.) | |
| | | 12 VDC/VAC | A165L-T□M-12-2 | A165L-T□A-12-2 | | |
| | | 24 VDC/VAC | A165L-T□M-24-2 | A165L-T□A-24-2 | | |
| Non-lighted | | | A165-T□M-2 | A165-T□A-2 | | |

- Note:** 1. Enter the desired color symbol for the Pushbutton in the □.
 2. Black ("B") Pushbuttons are only available for non-lighted models.

Other Models

Models with Reduced-voltage Lighting and Solder Terminals

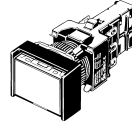

IP40

| Output | Lighting | Operating voltage | Momentary operation (Self-resetting) | Alternate operation (Self-holding) | Pushbutton color symbol (See note 1.) |
|--------|---|-------------------|--------------------------------------|------------------------------------|---|
| SPDT | LED (with built-in reduced-voltage lighting function) | 100/110 VAC/VDC | A16L-Δ□M-T1-1 | A16L-Δ□A-T1-1 | R: red Y: yellow PY: pure yellow G: green W: white A: blue |
| DPDT | | 100/110 VAC/VDC | A16L-Δ□M-T1-2 | A16L-Δ□A-T1-2 | |

IP65

| Output | Lighting | Operating voltage | Momentary operation (Self-resetting) | Alternate operation (Self-holding) | Pushbutton color symbol (See note 1.) |
|--------|---|-------------------|--------------------------------------|------------------------------------|---|
| SPDT | LED (with built-in reduced-voltage lighting function) | 100/110 VAC/VDC | A165L-Δ□M-T1-1 | A165L-Δ□A-T1-1 | R: red Y: yellow PY: pure yellow G: green W: white A: blue |
| DPDT | | 100/110 VAC/VDC | A165L-Δ□M-T1-2 | A165L-Δ□A-T1-2 | |

- Note:** 1. Enter the desired shape for the Pushbutton in Δ: J (rectangular), A (square), or T (round). Enter the desired color symbol for the Pushbutton in the □.
 2. Models with rated voltage 200 to 220 VAC/VDC (T2 models) are only available with Screw-Less Clamps.

Screw-Less Clamp Models

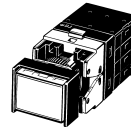

IP40

| Output | Lighting | Operating voltage | Momentary operation (Self-resetting) | Alternate operation (Self-holding) | Pushbutton color symbol (See note 1.) |
|-------------|---|-------------------|--------------------------------------|------------------------------------|---|
| DPDT | LED | 5 VDC | A16L-Δ□M-5D-2S | A16L-Δ□A-5D-2S | R: red Y: yellow PY: pure yellow G: green W: white A: blue B: black (See note 2.) |
| | | 12 VDC | A16L-Δ□M-12D-2S | A16L-Δ□A-12D-2S | |
| | | 24 VDC | A16L-Δ□M-24D-2S | A16L-Δ□A-24D-2S | |
| | LED (with built-in reduced-voltage lighting function) | 100/110 VAC/VDC | A16L-Δ□M-T1-2S | A16L-Δ□A-T1-2S | |
| | | 200/220 VAC/VDC | A16L-Δ□M-T2-2S | A16L-Δ□A-T2-2S | |
| Non-lighted | | | A16-Δ□M-2S | A16-Δ□A-2S | |

IP65

| Output | Lighting | Operating voltage | Momentary operation (Self-resetting) | Alternate operation (Self-holding) | Pushbutton color symbol (See note 1.) |
|-------------|---|-------------------|--------------------------------------|------------------------------------|---|
| DPDT | LED | 5 VDC | A165L-Δ□M-5D-2S | A165L-Δ□A-5D-2S | R: red Y: yellow PY: pure yellow G: green W: white A: blue B: black (See note 2.) |
| | | 12 VDC | A165L-Δ□M-12D-2S | A165L-Δ□A-12D-2S | |
| | | 24 VDC | A165L-Δ□M-24D-2S | A165L-Δ□A-24D-2S | |
| | LED (with built-in reduced-voltage lighting function) | 100/110 VAC/VDC | A165L-Δ□M-T1-2S | A165L-Δ□A-T1-2S | |
| | | 200/220 VAC/VDC | A165L-Δ□M-T2-2S | A165L-Δ□A-T2-2S | |
| Non-lighted | | | A165-Δ□M-2S | A165-Δ□A-2S | |

- Note:** 1. Enter the desired shape for the Pushbutton in Δ: J (rectangular), A (square), or T (round). Enter the desired color symbol for the Pushbutton in the □.
 2. Black ("B") Pushbuttons are only available for non-lighted models.

A165□-BA (24-mm Square) Models

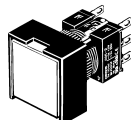

Solder Terminals

IP65

| Output | Lighting | Operating voltage | Momentary operation (Self-resetting) | Alternate operation (Self-holding) | Pushbutton color symbol (See note 1.) |
|--------|-------------|-------------------|--------------------------------------|------------------------------------|---|
| SPDT | LED | 5 VDC | A165L-BA□M-5D-1 | A165L-BA□A-5D-1 | R: red Y: yellow PY: pure yellow G: green W: white A: blue B: black (See note 2.) |
| | LED | 12 VDC | A165L-BA□M-12D-1 | A165L-BA□A-12D-1 | |
| | LED | 24 VDC | A165L-BA□M-24D-1 | A165L-BA□A-24D-1 | |
| | Non-lighted | | A165-BA□M-1 | A165-BA□A-1 | |
| DPDT | LED | 5 VDC | A165L-BA□M-5D-2 | A165L-BA□A-5D-2 | |
| | LED | 12 VDC | A165L-BA□M-12D-2 | A165L-BA□A-12D-2 | |
| | LED | 24 VDC | A165L-BA□M-24D-2 | A165L-BA□A-24D-2 | |
| | Non-lighted | | A165-BA□M-2 | A165-BA□A-2 | |

- Note:**
1. Enter the desired color symbol for the Pushbutton in the □.
 2. Black ("B") Pushbuttons are only available for non-lighted models.

Ordering Individually

Pushbuttons, Lamps, Cases, and Switches (Sockets) can be ordered separately. Combinations that are not available as sets can be created using individual Units. Also, store the parts as spares for maintenance and repairs.

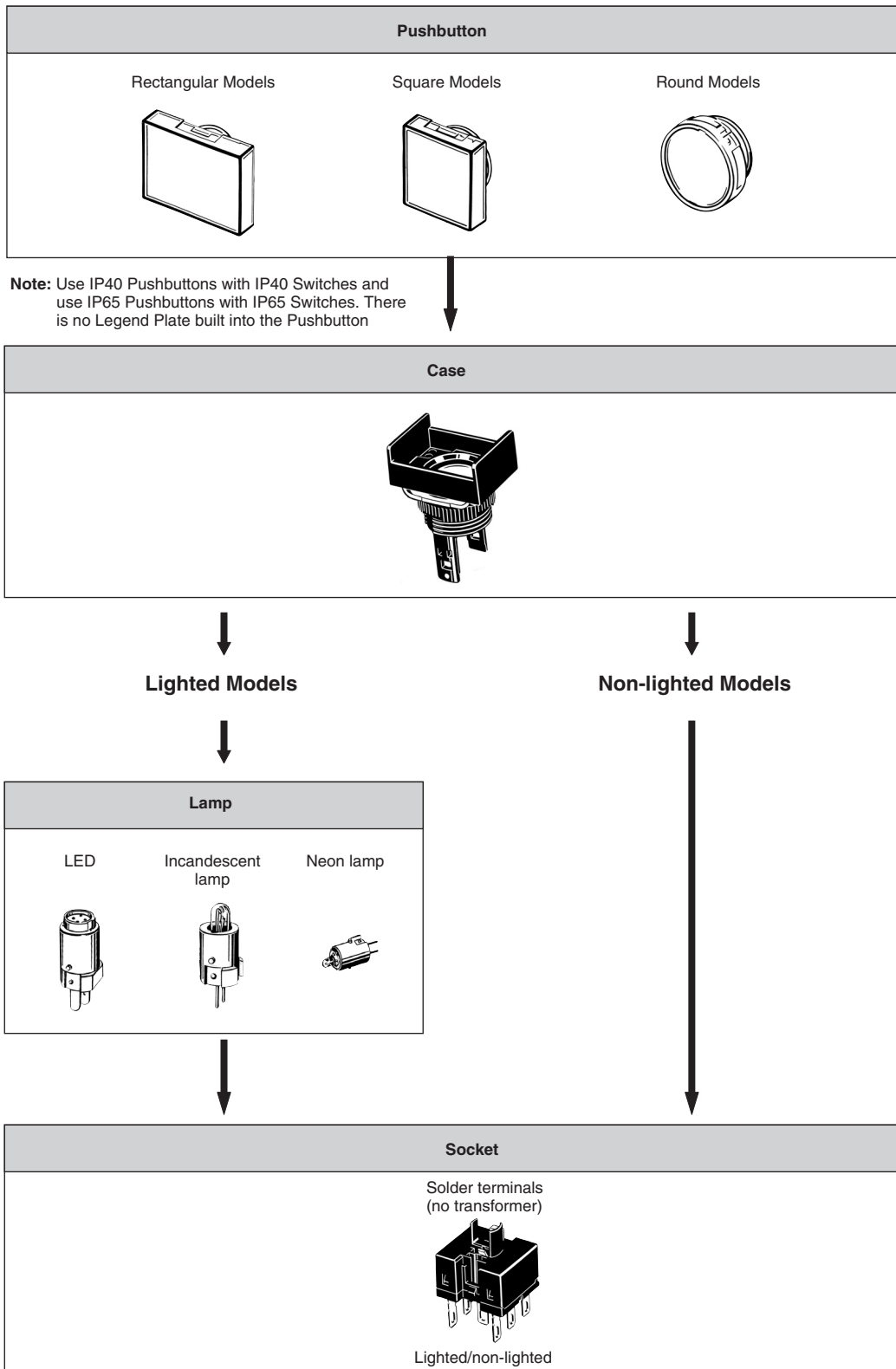







Pushbutton Switches







Pushbuttons

Illumination: red, yellow, and white use either LED or incandescent lamps.







LED

| Degree of protection | IP40 | | | Oil-resistant IP65 | | |
|----------------------|--|---|--|---|---|--|
| | Rectangular  | Square  | Round  | Rectangular  | Square  | Round  |
| Red | A16L-JR | A16L-AR | A16L-TR | A165L-JR | A165L-AR | A165L-TR |
| Yellow | A16L-JY | A16L-AY | A16L-TY | A165L-JY | A165L-AY | A165L-TY |
| Pure yellow | A16L-JPY | A16L-APY | A16L-TPY | A165L-JPY | A165L-APY | A165L-TPY |
| Green | A16L-JGY | A16L-AGY | A16L-TGY | A165L-JGY | A165L-AGY | A165L-TGY |
| White | A16L-JW | A16L-AW | A16L-TW | A165L-JW | A165L-AW | A165L-TW |
| Blue | A16L-JA | A16L-AA | A16L-TA | A165L-JA | A165L-AA | A165L-TA |







Incandescent Lamps (With the exception of green, the Units are the same as for LEDs.)

| Degree of protection | IP40 | | | Oil-resistant IP65 | | |
|----------------------|--|---|--|---|---|--|
| | Rectangular  | Square  | Round  | Rectangular  | Square  | Round  |
| Red | A16L-JR | A16L-AR | A16L-TR | A165L-JR | A165L-AR | A165L-TR |
| Yellow | A16L-JY | A16L-AY | A16L-TY | A165L-JY | A165L-AY | A165L-TY |
| Pure yellow | A16L-JPY | A16L-APY | A16L-TPY | A165L-JPY | A165L-APY | A165L-TPY |
| Green | A16L-JG | A16L-AG | A16L-TG | A165L-JG | A165L-AG | A165L-TG |
| White | A16L-JW | A16L-AW | A16L-TW | A165L-JW | A165L-AW | A165L-TW |
| Blue | A16L-JA | A16L-AA | A16L-TA | A165L-JA | A165L-AA | A165L-TA |



Non-lighted (Same as Units for incandescent lamps.)

| Degree of protection | IP40 | | | Oil-resistant IP65 | | |
|----------------------|--|---|--|---|---|--|
| | Rectangular  | Square  | Round  | Rectangular  | Square  | Round  |
| Red | A16L-JR | A16L-AR | A16L-TR | A165L-JR | A165L-AR | A165L-TR |
| Yellow | A16L-JY | A16L-AY | A16L-TY | A165L-JY | A165L-AY | A165L-TY |
| Pure yellow | A16L-JPY | A16L-APY | A16L-TPY | A165L-JPY | A165L-APY | A165L-TPY |
| Green | A16L-JG | A16L-AG | A16L-TG | A165L-JG | A165L-AG | A165L-TG |
| White | A16L-JW | A16L-AW | A16L-TW | A165L-JW | A165L-AW | A165L-TW |
| Blue | A16L-JA | A16L-AA | A16L-TA | A165L-JA | A165L-AA | A165L-TA |
| Black | A16L-JB | A16L-AB | A16L-TB | A165L-JB | A165L-AB | A165L-TB |

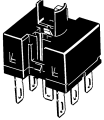
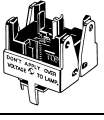

Neon Lamps

| Degree of protection | IP40 | | | Oil-resistant IP65 | | |
|----------------------|--|---|--|---|---|--|
| | Rectangular  | Square  | Round  | Rectangular  | Square  | Round  |
| Red | A16L-JRN | A16L-ARN | A16L-TRN | A165L-JRN | A165L-ARN | A165L-TRN |
| Green | A16L-JGN | A16L-AGN | A16L-TGN | A165L-JGN | A165L-AGN | A165L-TGN |
| White | A16L-JWN | A16L-AWN | A16L-TWN | A165L-JWN | A165L-AWN | A165L-TWN |

Switches

| Appearance | Classification | | | Model | |
|---|----------------------------------|--------------------------------------|------|------------------|--------|
|  | Lighted/non-lighted (common use) | Standard load/microload (common use) | SPDT | Solder terminal | A16-1 |
| | | | DPDT | | A16-2 |
|  | | | SPDT | PCB terminal | A16-1P |
| | | | DPDT | | A16-2P |
|  | | | DPDT | Screw-Less Clamp | A16-2S |

Switches with Reduced-voltage Lighting

| Appearance | Classification | | | Model | |
|--|----------------|--------------------------------------|------|------------------|------------------------|
|  | 100 V | Standard load/microload (common use) | SPDT | Solder terminal | A16-T1-1 |
| | | | DPDT | | A16-T1-2 |
|  | 100 V 200 V | | DPDT | Screw-less clamp | A16-T1-2S A16-T2-2S |

Lamps

LED

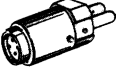
| Operating voltage | 5 VDC | 12 VDC | 24 VDC |
|---|----------|-----------|-----------|
|  | | | |
| Light color | | | |
| Red | A16-5DSR | A16-12DSR | A16-24DSR |
| Yellow | A16-5DSY | A16-12DSY | A16-24DSY |
| Green | A16-5DSG | A16-12DSG | A16-24DSG |
| White (See note.) | A16-5DSW | A16-12DSW | A16-24DSW |
| Blue | A16-5DA | A16-12DA | A16-24DA |

Note: Use the white LED together with white or pure yellow Pushbuttons.

Incandescent Lamp

| Operating voltage | 5 VAC/VDC | 12 VAC/VDC | 24 VAC/VDC |
|---|-----------|------------|------------|
|  | | | |
| Model | A16-5 | A16-12 | A16-24 |

Neon Lamp

| Operating voltage | 100 VAC | 200 VAC |
|---|----------|----------|
|  | | |
| Red (See note.) | A16-1NRN | A16-2NRN |
| Green | A16-1NGN | A16-2NGN |



Note: Use the red neon lamp with red or white Pushbuttons.

Cases





| Appearance | Classification | | | Model |
|---|--------------------|---------------------|---------------------------|-----------|
|  | IP40 | Momentary operation | Rectangular (2-way guard) | A16-CJM |
| | | | Rectangular (3-way guard) | A16-C3JM |
| | | | Square | A16-CAM |
| | | | Round | A16-CTM |
| | | Alternate operation | Rectangular (2-way guard) | A16-CJA |
| | | | Rectangular (3-way guard) | A16-C3JA |
| | | | Square | A16-CAA |
| | | | Round | A16-CTA |
| | Oil-resistant IP65 | Momentary operation | Rectangular (2-way guard) | A165-CJM |
| | | | Rectangular (3-way guard) | A165-C3JM |
| | | | Square | A165-CAM |
| | | Alternate operation | Round | A165-CTM |
| Rectangular (2-way guard) | | | A165-CJA | |
| Rectangular (3-way guard) | | | A165-C3JA | |
| | Square | A165-CAA | | |
| | Round | A165-CTA | | |

Accessories (Order Separately)



Accessories

| Name | Appearance | Classification | Model | Remarks |
|---------------|---|-----------------------------|------------|---|
| Switch Guards |  | For rectangular models | A16ZJ-5050 | Cannot be used with the Dust Cover. |
| | | For square and round models | A16ZA-5050 | |
| Dust Covers |  | For rectangular models | A16ZJ-5060 | Cannot be used with the Switch Guard. |
| | | For square models | A16ZA-5060 | |
| | | For round models | A16ZT-5060 | |
| Panel Plugs |  | For rectangular models | A16ZJ-3003 | Used for covering the panel cutouts for future panel expansion. |
| | | For square models | A16ZA-3003 | |
| | | For round models | A16ZT-3003 | |

Replacements

| Name | Appearance | Classification | | Model | Remarks | | |
|---|--|---|---|--------------|--|--|------------|
| Legend Plates |  | Rectangular | IP40 | Milky | A16ZJ-5204 | A single Legend Plate (transparent) is included with a standard model. The milky Legend Plate can be used with the IP40 and oil-resistant IP65. | |
| | | | | Transparent | A16ZJ-5202 | | |
| | | | Oil-resistant IP65 | Milky | A16ZJ-5204 | | |
| | | | | Transparent | A16ZJ-5203 | | |
| | | | Square | IP40 | Milky | | A16ZA-5204 |
| | | | | | Transparent | | A16ZA-5202 |
| | | Oil-resistant IP65 | | Milky | A16ZA-5204 | | |
| | | | | Transparent | A16ZA-5203 | | |
| | | Round | IP40 | Milky | A16ZT-5204 | | |
| | | | | Transparent | A16ZT-5202 | | |
| | | | Oil-resistant IP65 | Milky | A16ZT-5204 | | |
| | | | | Transparent | A16ZT-5203 | | |
| Color Caps (for IP40) | Rectangular  | LED indicator/incandescent lamp/non-lighted | White | A16Z□-5001W | Insert one of the following letters into the box (□). J: Rectangular A: Square T: Round The Color Cap is usually supplied. Replace the Cap if the color is to be changed. When using an LED indicator, be sure to use a Color Cap that matches the luminescent color of the LED. The materials used for the IP40 and oil-resistant IP65 are different so be sure to use a Color Cap that matches the specifications of the Switch. | | |
| | | | Red | A16Z□-5001R | | | |
| | | | Yellow | A16Z□-5001Y | | | |
| | | LED indicator | Pure yellow | A16Z□-5001PY | | | |
| | | | Green | A16Z□-5001GY | | | |
| | | | Incandescent lamp/non-lighted | Blue | | A16Z□-5001A | |
| | Green | A16Z□-5001G | | | | | |
| | Square  | Non-lighted | Black | A16Z□-5011B | | | |
| | | | LED indicator/incandescent lamp/non-lighted | White | | A16Z□-5101W | |
| | | Red | | A16Z□-5101R | | | |
| Yellow | | A16Z□-5101Y | | | | | |
| Round  | LED indicator | Pure yellow | A16Z□-5101PY | | | | |
| | | Green | A16Z□-5101GY | | | | |
| | Incandescent lamp/non-lighted | Blue | A16Z□-5101A | | | | |
| | | Green | A16Z□-5101G | | | | |
| Non-lighted | Black | A16Z□-5111B | | | | | |

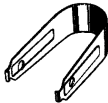
Tools

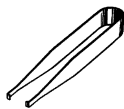
| Name | Appearance | Model | Applicable types | | | | | Remarks |
|----------------------|---|-----------|-------------------|---------------------------|--------------------------|-----------------------|-----------|---|
| | | | Pushbutton Switch | Knob-type Selector Switch | Key-type Selector Switch | Emergency Stop Switch | Indicator | |
| Extractor |  | A3PJ-5080 | Yes | No | No | No | Yes | Convenient for extracting Pushbutton Switches |
| Screw Fitting |  | A16Z-3004 | Yes | Yes | Yes | Yes | Yes | Convenient for ganged installation. Tighten to a torque of 0.39 N · m min. |
| Extractor |  | A16Z-5080 | Yes | Yes | Yes | Yes | Yes | Convenient for extracting the Switch and Lamps. |

Specifications

■ Approved Standards

| Agency | Standards | File No. |
|---------------------|-------------|----------|
| UL, cUL (See note.) | UL508 | E41515 |
| --- | EN60947-5-1 | --- |

Note: cUL: CSA, C22.2 No. 14

■ Approved Standard Ratings

UL, cUL (File No. E41515)

5 A at 125 VAC, 3 A at 250 VAC (general use)
3 A at 30 VDC (resistive)

EN60947-5-1 (Low Voltage Directive)

3 A at 250 VAC (AC12), 3 A at 30 VDC (DC12)

■ Ratings

Contacts

| AC resistive load | DC resistive load |
|----------------------------------|-------------------|
| 3 A at 250 VAC 5 A at 125 VAC | 3 A at 30 VDC |

Minimum applicable load: 1 mA at 5 VDC

Rated values are obtained from tests conducted under the following conditions.

1. Load: Resistive load
2. Mounting conditions: No vibration and no shock
3. Temperature: 20±2°C
4. Operating frequency: 20 operations/min

Super-bright LED

| Rated voltage | Rated current | Operating voltage | Internal limiting resistor |
|---------------|---------------|-------------------|----------------------------|
| 5 VDC | 30 mA (15 mA) | 5 VDC±5% | 33 Ω (68 Ω) |
| 12 VDC | 15 mA | 12 VDC±5% | 270 Ω (560 Ω) |
| 24 VDC | 10 mA | 24 VDC±5% | 1600 Ω (2,000 Ω) |

Note: The values in parentheses are for models with blue Pushbuttons.

Incandescent Lamp

| Rated voltage | Rated current | Operating voltage |
|---------------|---------------|-------------------|
| 6 VAC/VDC | 60 mA | 5 VAC/VDC |
| 14 VAC/VDC | 40 mA | 12 VAC/VDC |
| 28 VAC/VDC | 24 mA | 24 VAC/VDC |

■ Characteristics

| Item | | Pushbutton Switch |
|---------------------------------|-------------|---|
| Allowable operating frequency | Mechanical | Momentary operation: 120 operations/minute max. (See note 1.) Alternate operation: 60 operations/minute max. (See note 1.) |
| | Electrical | 20 operations/minute max. (See note 1.) |
| Insulation resistance | | 100 MΩ min. (at 500 VDC) |
| Dielectric strength | | 1,000 VAC, 50/60 Hz for 1 min between terminals of same polarity 2,000 VAC, 50/60 Hz for 1 min between terminals of different polarity and also between each terminal and ground 1,000 VAC, 50/60 Hz for 1 min between lamp terminals (See note 2.) |
| Vibration resistance | Malfunction | 10 to 55 Hz, 1.5-mm double amplitude (malfunction within 1 ms) |
| Shock resistance | Mechanical | 500 m/s ² |
| | Malfunction | 150 m/s ² max. (malfunction within 1 ms) |
| Durability | Mechanical | Momentary operation: 2,000,000 operations min. Alternate operation: 200,000 operations min. (See note 1.) |
| | Electrical | 100,000 operations min. (See note 1.) |
| Ambient temperature | | Operating: -10°C to 55°C (with no icing or condensation) Storage: -25°C to 65°C (with no icing or condensation) |
| Ambient humidity | | Operating: 35% to 85% |
| Electric shock protection class | | Class II |
| PTI (tracking characteristic) | | 175 |
| Degree of contamination | | 3 (IEC947-5-1) |
| Weight | | Approx. 10 g (in the case of a lighted DPDT switch with solder terminals) |

- Note: 1. Set and reset constitute one operation.
2. With LED and incandescent lamp not mounted.

Screw-Less Clamp

| Item | | Screw-Less Clamp | | | |
|-----------------------------------|------------------|--|---------------------|----------------------|----------------------|
| Recommended wire size | | 0.5 mm ² twisted wire or 0.8 mm-dia. solid wire | | | |
| Usable wires and tensile strength | Twisted wire | 0.3 mm ² | 0.5 mm ² | 0.75 mm ² | 1.25 mm ² |
| | Solid wire | 0.5 mm dia. | 0.8 mm dia. | 1.0 mm dia. | --- |
| | Tensile strength | 10 N | 20 N | 30 N | 40 N |
| Length of exposed wire | | 10 ±1 mm | | | |

■ Operating Characteristics

| Features | Type | Pushbutton Switch | | | |
|---------------------------------------|------|-------------------|--------|--------------------|--------|
| | | IP40 | | Oil-resistant IP65 | |
| | | SPDT | DPDT | SPDT | DPDT |
| Operating force (OF) max. | | 2.45 N | 4.41 N | 2.94 N | 4.91 N |
| Releasing force (RF) min. | | 0.29 N | | | |
| Total travel (TT) | | Approx. 3 mm | | | |
| Pretravel (PT) max. | | 2.5 mm | | | |
| Lock stroke (LTA) min. (See note.) | | 0.5 mm | | | |

Note: Lock stroke is only for alternate operation.

■ Contact Form

| Name | Contact |
|------|---------|
| DPDT | |

Nomenclature

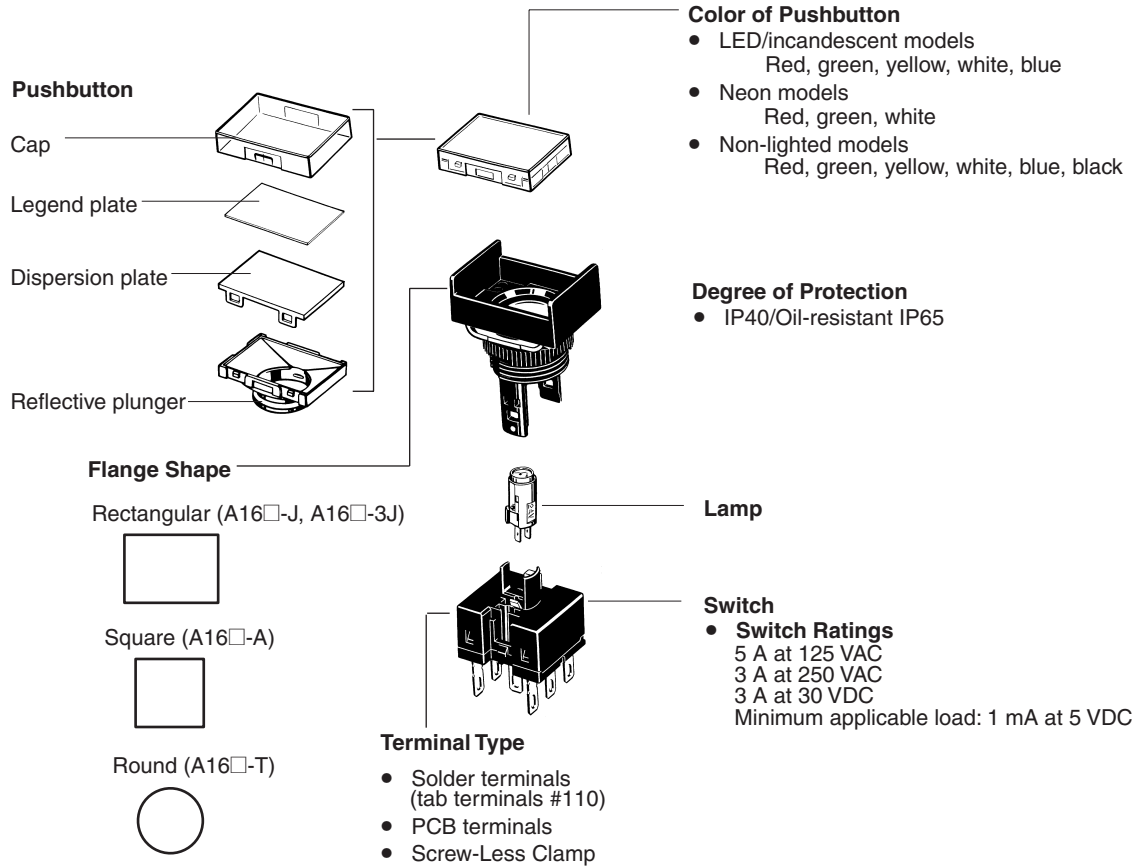

Dimensions

Note: All units are in millimeters unless otherwise indicated.

Lighted/Non-lighted Pushbutton Switches without Voltage Reduction Unit

The lamp terminal is also provided with non-lighted models.

Solder terminals and tab terminals (#110) can be both used with Lighted and Non-lighted Pushbutton Switches.

Rectangular

A16□-J

Solder terminals (tab terminals #110)

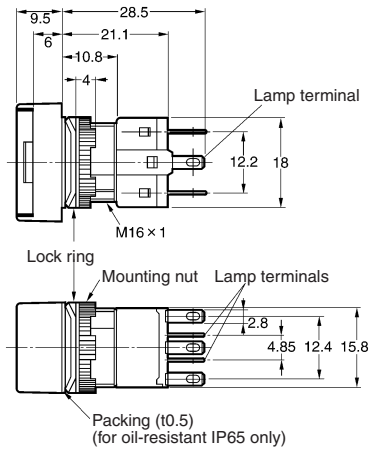
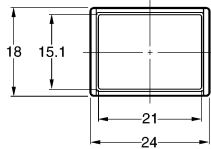
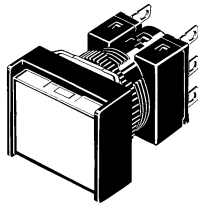

Panel Cutouts

See page 25 for panel cutouts

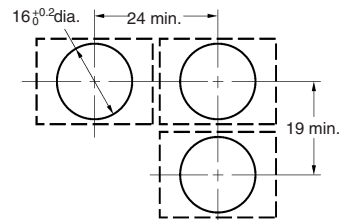

Square

A16□-A

Solder terminals (tab terminals #110)

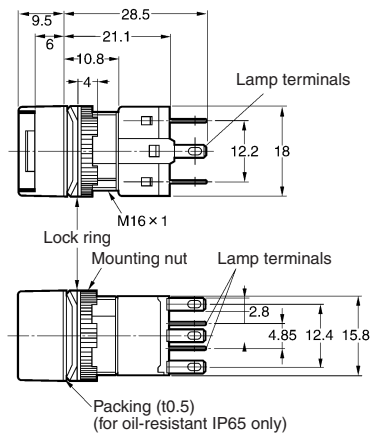
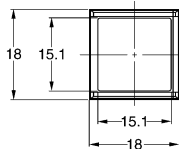
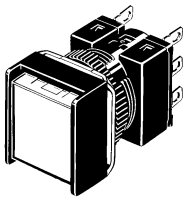

Panel Cutouts

See page 25 for panel cutouts

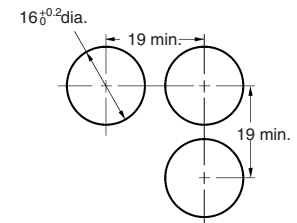

Rectangular

A16□-3J

Solder terminals (tab terminals #110)

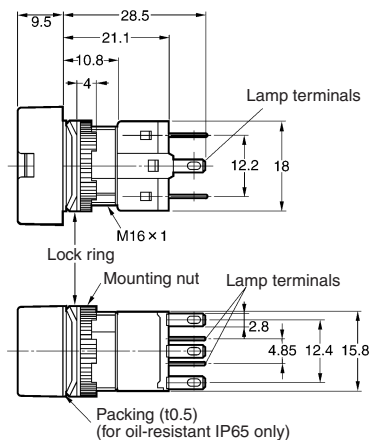
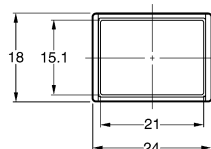
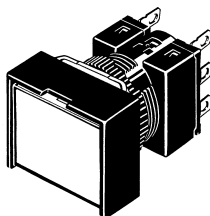

Panel Cutouts

See page 25 for panel cutouts

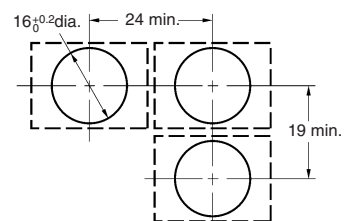

Pushbutton Switches

**Round
A16□-T**

Solder terminals (tab terminals #110)

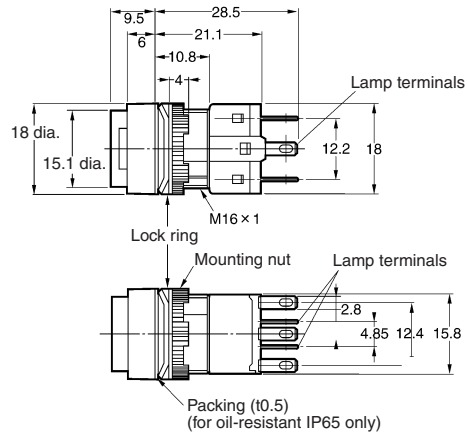
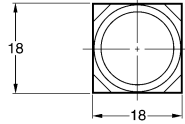
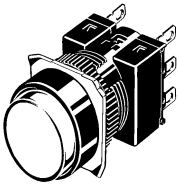

Panel Cutouts

See page 25 for panel cutouts

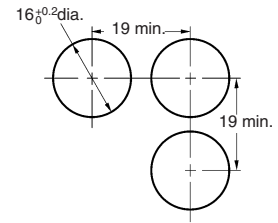

The following diagrams show the rectangular model as a representative example.

**Rectangular
A16□-J**
PCB terminals

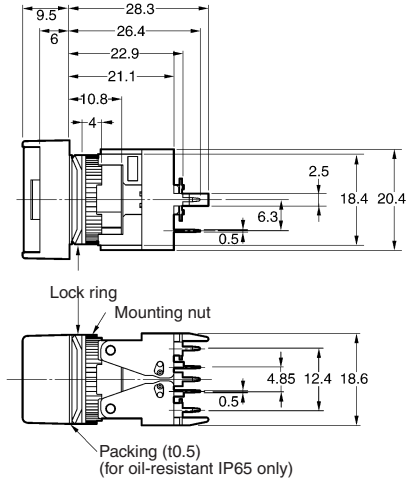
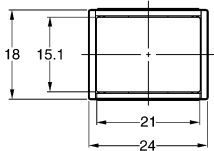
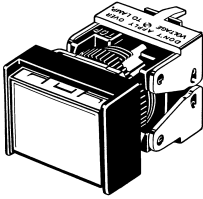

Panel Cutouts
See page 25 for panel cutouts

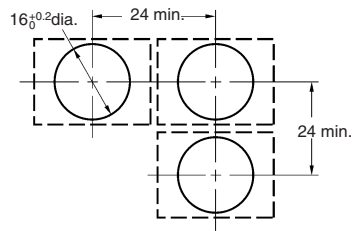

**Rectangular
A16□-T1, T2**
Voltage-reduction lighting,
solder terminals
(tab terminals #110)

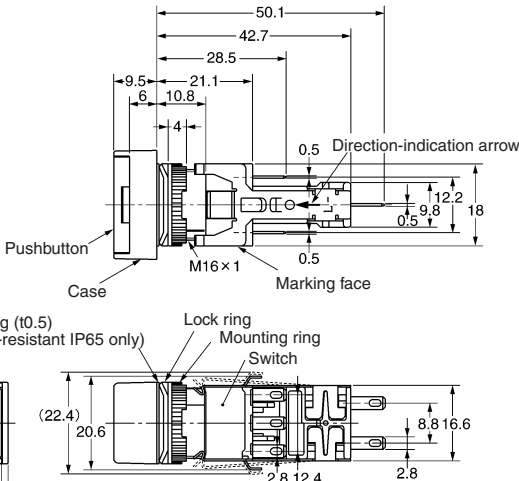
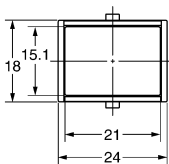
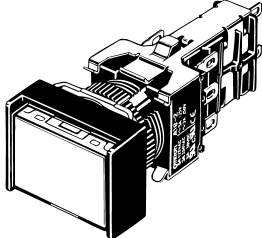

Panel Cutouts
See page 25 for panel cutouts

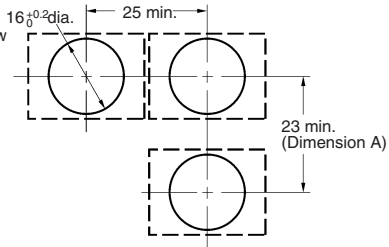

Recommended panel thickness: 0.5 to 3.2 mm

**Rectangular
A16□-2S**
Screw-Less Clamp

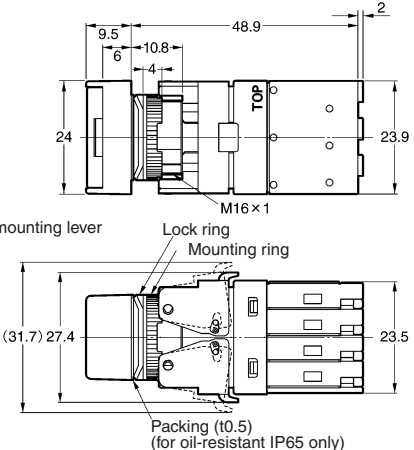
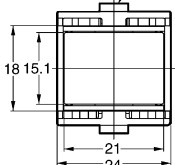
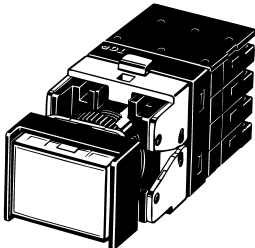

Panel Cutouts
See page 25 for panel cutouts

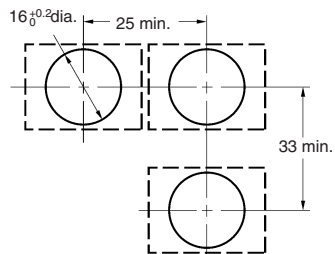

■ Lamps

LED
A16-5DS□/-12DS□/-24DS□

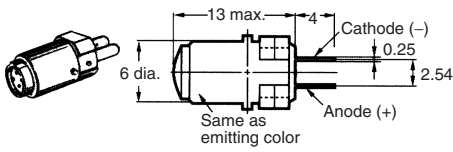

Incandescent Lamp
A16-5/-12/-24

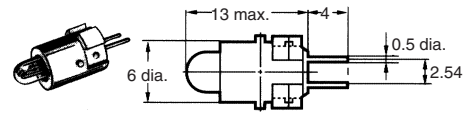

Neon Lamp
A16-1N/-2N

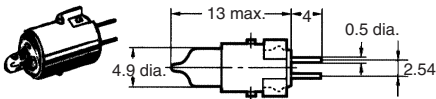

■ Accessories, Tools, and Components

Extractor
A3PJ-5080

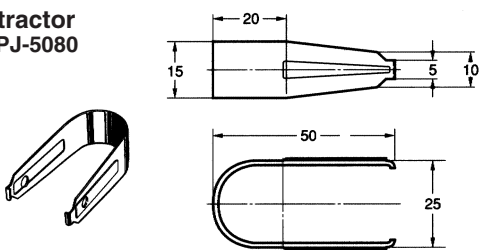

Legend Plates
A16ZJ-520□

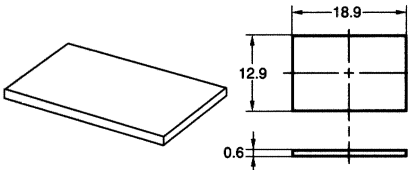

A16ZA-520□

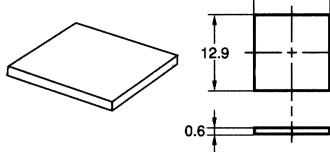

A16ZT-520□

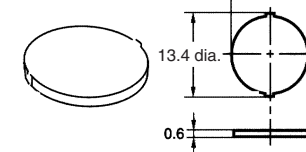

Note: 1. The panel is 0.6 mm thick.
2. The panel is made of the materials listed in the following table.

| Color | Degree of protection | Materials |
|-------------|----------------------|---------------------|
| Milky | IP40 | Polyacrylate resin |
| | IP65 | |
| Transparent | IP40 | Polycarbonate resin |
| | IP65 | Polyacrylate resin |

Note: The standard model is transparent.

Screw Fitting
A16Z-3004

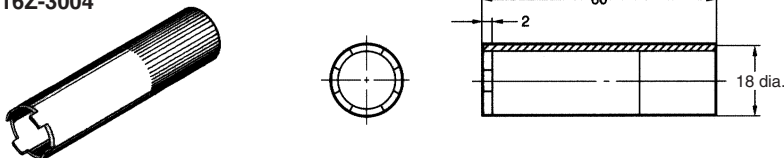

Panel Plugs (Black Resin)

Select the Plug that fits the panel design and mount from the front of the Panel. Panel cutouts are the same as those for Switches.

**Rectangular
A16ZJ-3003**

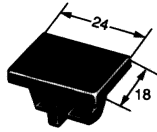

**Square
A16ZA-3003**

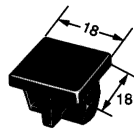

**Round
A16ZT-3003**



Lock Ring

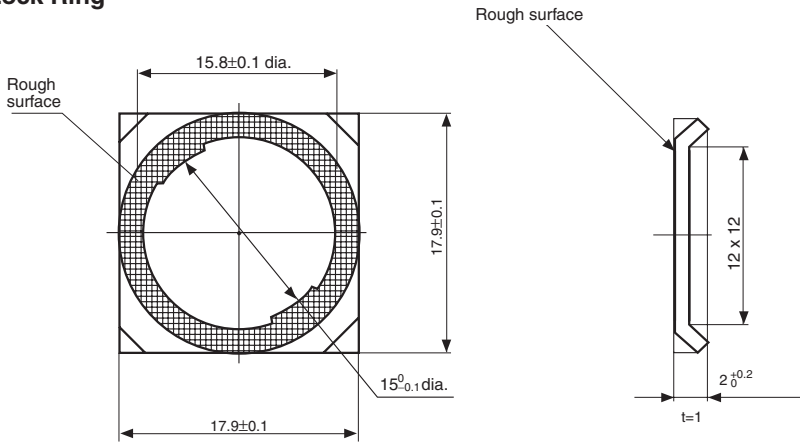

**Extractor
A16Z-5080**

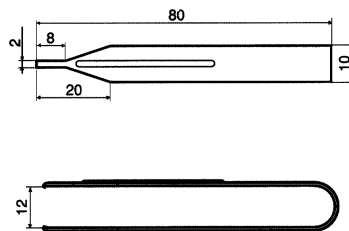
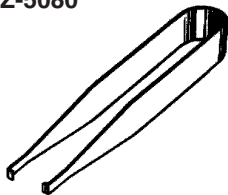

■ Dimensions with Accessories

Switch Guards

Rectangular A16ZJ-5050

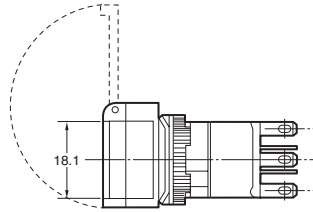
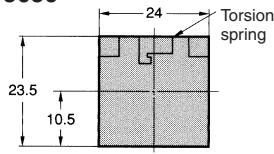

Panel Cutouts (Top View)

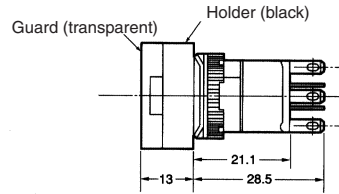
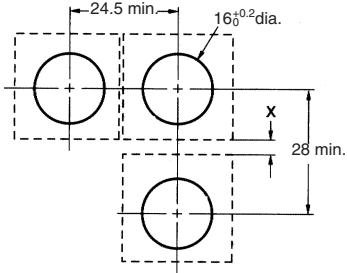

Note: The above illustration shows the case where 4.5 mm is provided for the distance "x." If no clearance is required for the "x" section, the vertical mounting dimension can be as small as 24 mm. Set this distance according to operating conditions.

Square A16ZA-5050

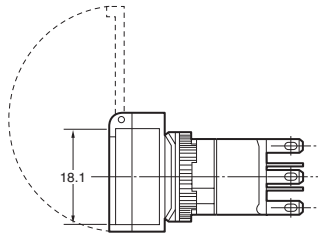
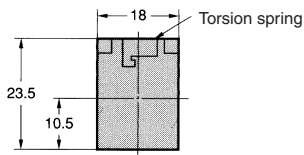

Panel Cutouts (Top View)

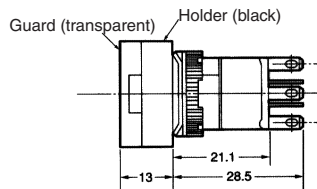
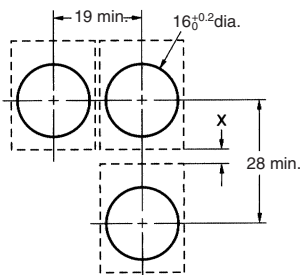

Note: The above illustration shows the case where 4.5 mm is provided for the distance "x." If no clearance is required for the "x" section, the vertical mounting dimension can be as small as 24 mm. Set this distance according to operating conditions. For models with PCB terminals, the horizontal mounting dimension is 24 mm min.

Dust Covers

**Rectangular
A16ZJ-5060**

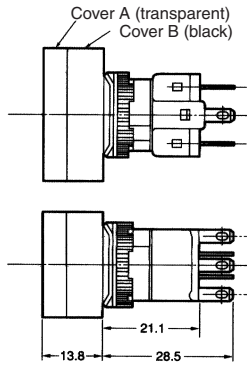
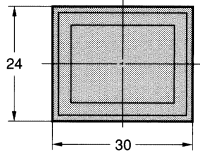

Panel Cutouts

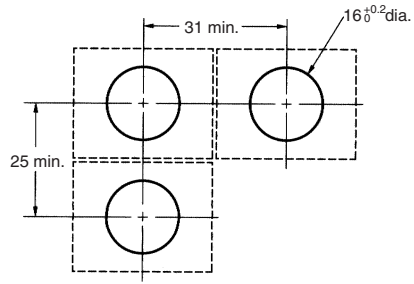

**Square
A16ZA-5060**

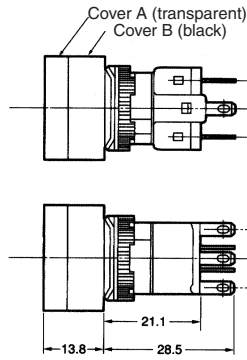
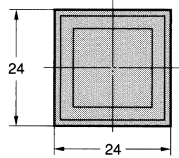

Panel Cutouts

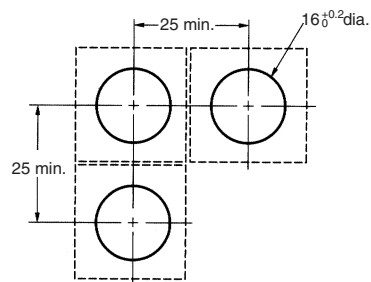

**Round
A16ZT-5050**

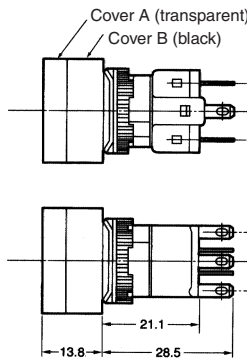
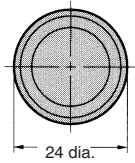

Panel Cutouts

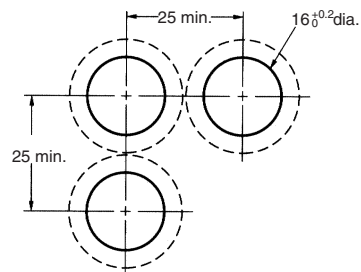

Terminal Arrangement

Models without Reduced-voltage Lighting

Non-lighted Pushbutton Switches are also provided with lamp terminals.

Solder Terminals

Lighted SPDT Switches

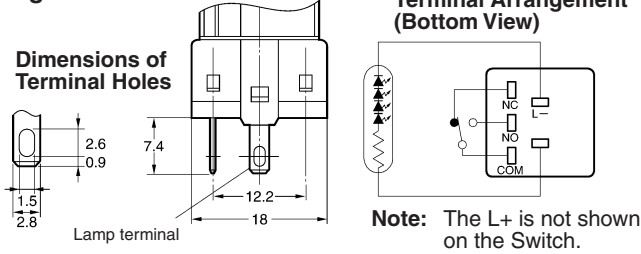

Lighted DPDT Switches

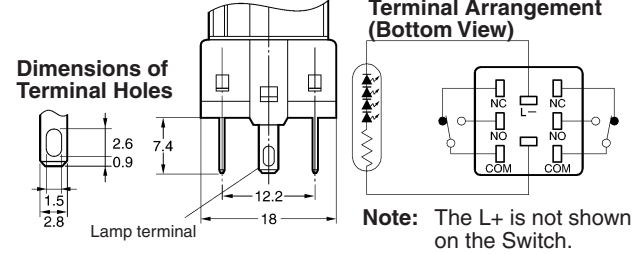

PCB Terminals

Lighted SPDT Switches

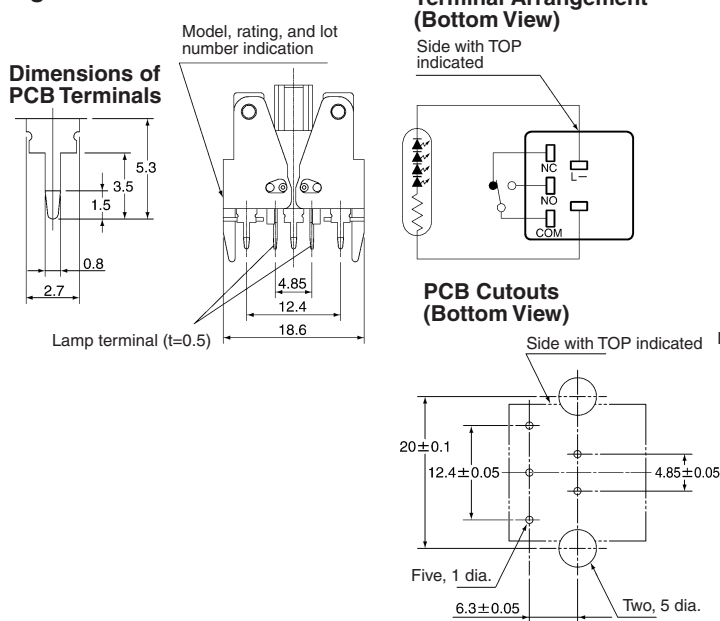

Lighted DPDT Switches

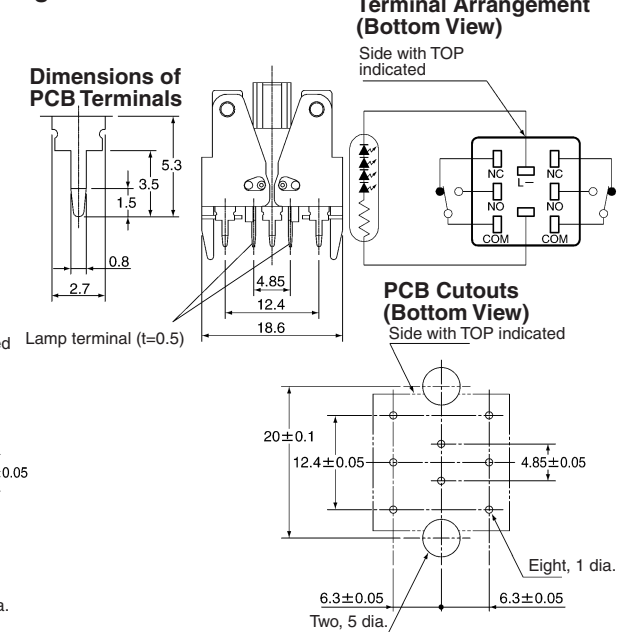

Voltage Reduction Units

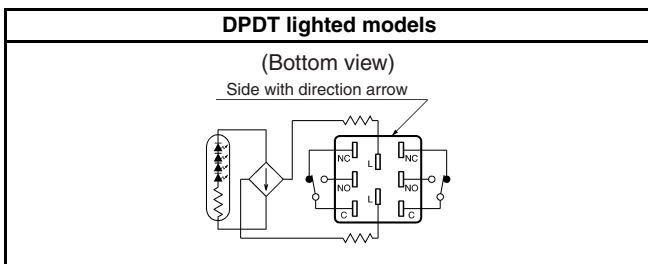

- The voltage-reduction circuit is built in.

Screw-Less Clamps

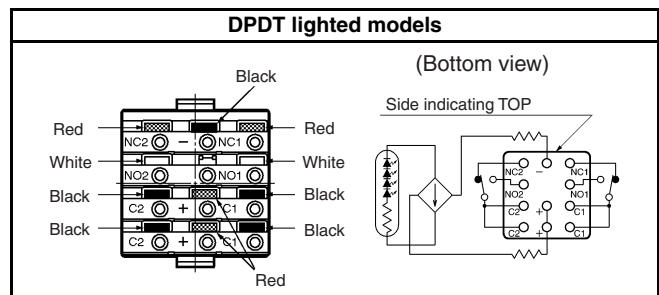

- Voltage-reduction lighting models with Screw-Less Clamps (A16L-□T1-2S, A16L-□T2-2S) incorporate voltage-reduction circuits.

■ Panel Cutouts

Solder Terminals

Rectangular A16□-J/M16□-□J
(Top View)

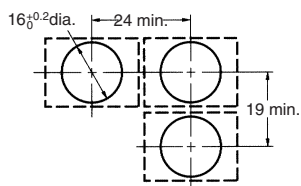

Square A16□-A/M16□-A
Round A16□-T/M16□-T
(Top View)

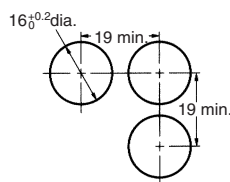

- Note:**
1. Make sure the thickness of the mounting panel is between 0.5 and 3.2 mm. If, however, a Switch Guard or Dust Cover is used, the thickness of the mounting panel must be between 0.5 and 2 mm.
 2. If the panel is to be finished with coating, etc., make sure that the panel meets the specified dimensions after coating.

PCB Terminals

Rectangular A16□-J/M16□-J
(Top View)

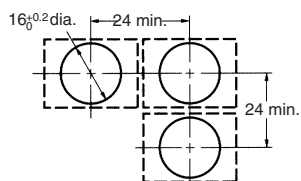

Square A16□-A/M16□-A, A165□-BA, M165-BA
Round A16□-T/M16□-T
(Top View)

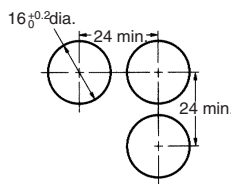

- Note:**
1. Ensure that the variation in the distance between the centers of neighboring mounting holes is less than ± 0.1 mm.
 2. Make sure the thickness of the mounting panel is between 0.5 and 3.2 mm. If, however, a Switch Guard or Dust Cover is used, the thickness of the mounting panel must be between 0.5 and 2 mm.
 3. If the panel is to be finished with coating, etc., make sure that the panel meets the specified dimensions after coating.

Installation

■ Panel Mounting

After mounting the Pushbutton Unit (i.e., the Pushbutton and the Case) to the panel, snap in the Switch Unit (i.e., the Switch and the Lamp) from the back of the panel.

Mounting to the Panel

Insert the Pushbutton Unit into the front of the panel, and fix the lock ring and mounting nut from the terminal side.

Make sure that the lock ring is aligned with the thread of the Case and the edge of the lock ring is touching the panel.

Tighten the mounting nuts to a torque of 0.29 to 0.49 N·m.

The maximum tightening torque is 0.49 N·m.

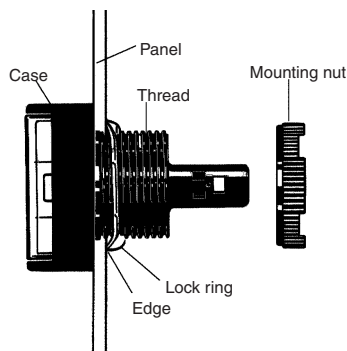

Mounting the Switch Unit

Snap on the Switch Unit to the Pushbutton Unit.

Make sure that the Switch Unit has the correct orientation when snapping it onto the Case. Align the • mark on the Case with the groove between the case guards on the NC terminal side of the Switch Unit in the way shown below, and push the Switch Unit into the Case until it clicks into place. Confirm that the Switch Unit is securely in place before using.

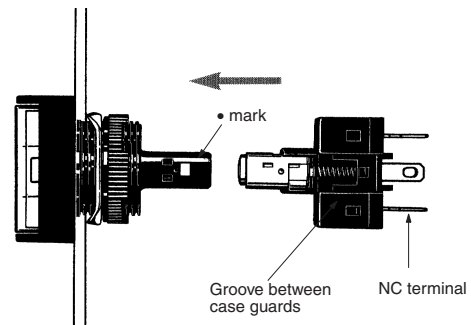

Mounting the Switch Unit for Voltage Reduction Types

1. The mounting panel thickness must be 0.5 to 3.2 mm.
2. The mounting ring must be tightened to a torque 0.29 to 0.49 N·m.
3. The mounting hole must be cut out in the way described previously. The dimension A is the length required for removing the Switch when it is in the mounted state. If Switches are mounted side-by-side separated by less than the specified distance, it may not be possible to remove the Switch.
4. Be sure to mount the Case to the Switch with the correct orientation. Mount with the • mark on the Case facing in the same direction as the side of the Switch with the direction arrow or the word TOP.



Removing the Switch Unit

Grip the part between the Switch holder of the Case and the Switch Unit using the A16Z-5080 Extractor, and pull to remove the Switch Unit.

- 16-mm Models

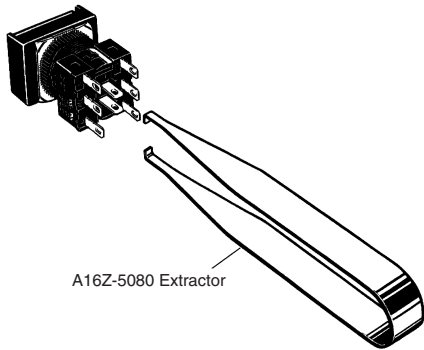

- A16-P Models (with PCB Terminals)

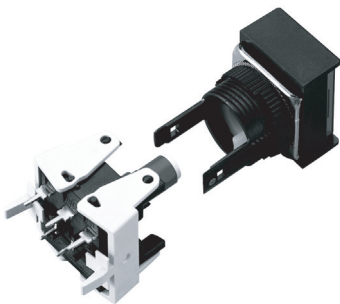

The Switch Unit can be mounted or dismounted by simply opening or closing the lever.

Mounting and Replacing the Pushbutton

Removing and Mounting the Pushbutton

1. Remove the Pushbutton as shown in the following diagram. If the Pushbutton cannot be removed by hand, use the A3PJ-5080 Extractor.

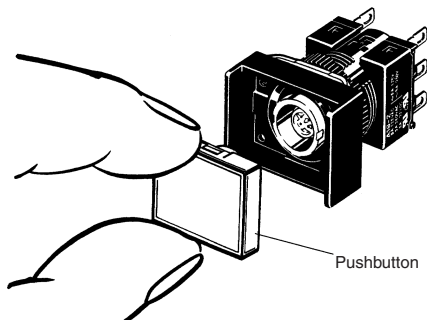

2. To attach the Pushbutton, push until it clicks into place.

Removing the Lamp

Removing from the Pushbutton End

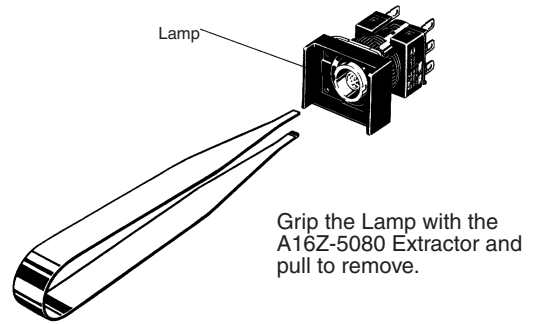

Removing from the Switch End

The Lamp can be removed by hand once the Switch is removed using the A16Z-5080 Extractor.

Installing the Lamp

When mounting the Lamp, make sure it is facing the direction shown in the following diagram. Insert the Lamp while matching the protruding part of the Lamp and the small guides on the outer surface of the Case.

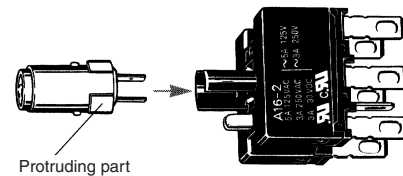

The Lamp can be mounted from the Pushbutton end by using the A16Z-5080 Extractor. The lamp can be mounted by following the opposite procedure for removing the Lamp.

■ Mounting the A16Z Dust Cover

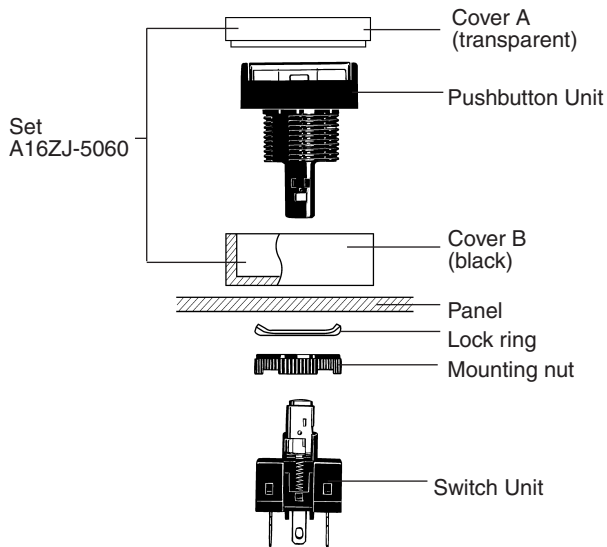

1. Separate the Dust Cover into 2 parts: cover A and cover B.
2. Insert the Case into cover B.
3. Mount these parts together onto the panel.
4. From the back of the panel, mount the lock ring and secure with the mounting nut.
5. Insert cover A into cover B. Ensure that the entire perimeter of cover A is securely attached to cover B by pressing in different directions.
6. Mount the Switch Unit to the Case.

Note: Recommended panel thickness: 0.5 to 2 mm.

■ Mounting the A16Z Switch Guard

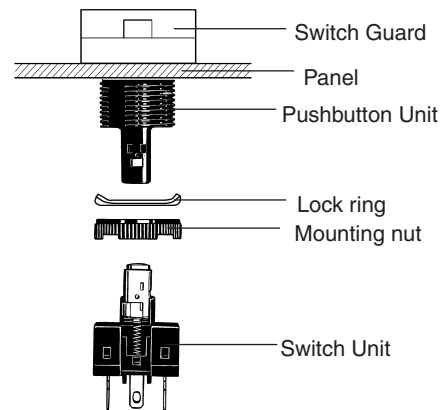

1. Insert the Case into the Switch Guard.
2. Mount these parts together onto the panel.
3. From the back of the panel, mount the lock ring and secure with the mounting nut.
4. Attach the Switch Unit to the Case.

Note: Recommended panel thickness: 0.5 to 2 mm.

Precautions

Refer to the *Technical Information for Pushbutton Switches* (Cat. No. A143).

⚠ WARNING

Do not apply a voltage between the incandescent lamp and the terminal that is greater than the rated voltage. If the incandescent lamp is broken, the operating part may pop out.

Always turn OFF the power and wait for 10 minutes before replacing the incandescent lamp. If the lamp is replaced immediately after the power is turned OFF, the remaining heat may cause burns.

Correct Use

Mounting

Always make sure that the power is turned OFF before mounting, removing, or wiring the Switch, or performing maintenance.

Do not tighten the mounting nut more than necessary using tools such as pointed-nose pliers. Doing so will damage the mounting nut. The tightening torque is 0.29 to 0.49 N·m.

Wiring

Solder Terminal

Solder terminals and quick-connect terminals (#110) are commonly used for terminals.

Be sure to use electrical wires that are a size appropriate for the applied voltage and carry current (conductor size is 0.5 to 0.75 mm²). Perform soldering according to the conditions provided below. If the soldering is not properly performed, the lead wires will become detached, resulting in short-circuits.

1. Hand soldering: 30 W, within 5 s
2. Dip soldering: 240°C, within 3 s

Wait for one minute after soldering before exerting any external force on the solder.

Use non-corrosive resin fluid as the flux.

Make sure that the electric cord is wired so that it does not touch the Unit. If the electric cord touches the Unit, then electric wires with a heat resistance of 100°C min. must be used.

After wiring the Switch, maintain an appropriate clearance and creepage distance.

Screw-Less Clamps

Mounting Procedure

1. Strip a length of 10 mm off the end of the wire (allowable range: 10±1 mm).
2. Bunch wire strands together and straighten them.
3. Insert the wire into the insertion hole while pressing the release button at the side of the hole. (Using a precision screwdriver is recommended.)
4. Let go of the release button to lock the wire into place.
5. After locking, pull on the wire gently to confirm that it is securely locked.

Removing Procedure

Remove wires by pulling them while pressing the release button.

Note: When reusing wires that have already been locked, cut off the end of the wire and strip the wire again before using.

Operating Environment

The IP65 model is designed with a degree of protection so that it will not sustain damage if it is subjected to water from any direction to the front of the panel.

Using the Microload

Insert a contact protection circuit, if necessary, to prevent the reduction of life expectancy due to extreme wear on the contacts caused by loads where inrush current occurs when the contact is opened and closed.

The A16 allows both a standard load (125 V at 5A, 250 V at 3 A) and a microload. If a standard load is applied, however, the microload area cannot be used. If the microload area is used with a standard load, the contact surface will become rough, and the opening and closing of the contact for a microload may become unreliable.

The minimum applicable load is the N-level reference value. This value indicates the malfunction reference level for the reliability level of 60% (λ 60) (conforming to JIS C5003).

The equation, λ 60 = 0.5×10^{-4} /operations indicates that the estimated malfunction rate is less than 1/2,000,000 operations with a reliability level of 60%.

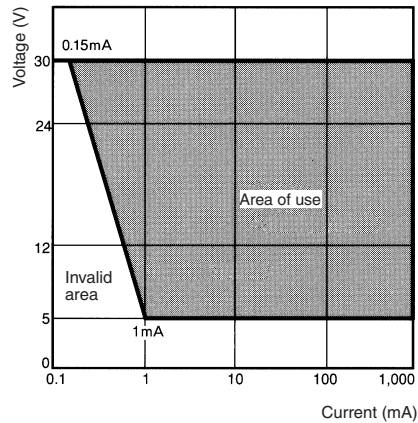

LED

The LED current-limiting resistor is built-in, so internal resistance is not required.

| Rated voltage | Internal limiting resistor |
|---------------|----------------------------|
| 5 VDC | 33 Ω (82 Ω) |
| 12 VDC | 270 Ω (470 Ω) |
| 24 VDC | 1600 Ω (2400 Ω) |

Note: The values in parentheses are for models with blue Pushbutton Units.

Others

The oil-resistant IP65 uses NBR rubber and is resistant to general cutting oil and cooling oil. Some particular oils cannot be used with the oil-resistant IP65, however, so contact your OMRON representative for details.

If the panel is to be finished with coating, etc., make sure that the panel meets the specified dimensions after the coating.

Do not subject the Switch to extreme shock or vibration. Doing so will cause malfunctions and damage to the Switch.

Do not let sharp objects come into contact with the Switches that are made of resin. Doing so will damage the Switches, causing scratches on the outside of the operating parts, and malfunction.

When handling the Switches, do not throw or drop them.

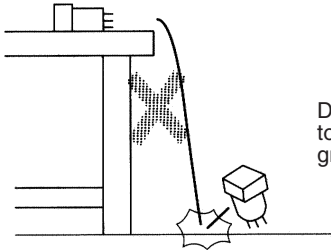

Do not allow the Switch to drop and hit the ground.

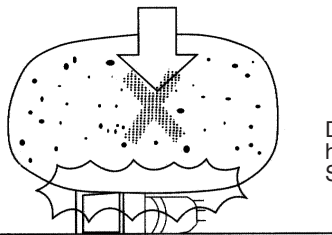

Do not place or drop heavy objects on the Switch.

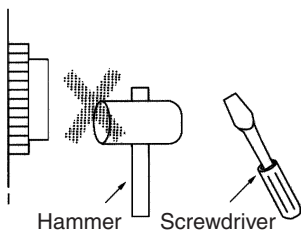

Do not operate the Switch with hard or sharp objects.

ALL DIMENSIONS SHOWN ARE IN MILLIMETERS.

To convert millimeters into inches, multiply by 0.03937. To convert grams into ounces, multiply by 0.03527.

Данный компонент на территории Российской Федерации

Вы можете приобрести в компании MosChip.

Для оперативного оформления запроса Вам необходимо перейти по данной ссылке:

<http://moschip.ru/get-element>

Вы можете разместить у нас заказ для любого Вашего проекта, будь то серийное производство или разработка единичного прибора.

В нашем ассортименте представлены ведущие мировые производители активных и пассивных электронных компонентов.

Нашей специализацией является поставка электронной компонентной базы двойного назначения, продукции таких производителей как XILINX, Intel (ex.ALTERA), Vicor, Microchip, Texas Instruments, Analog Devices, Mini-Circuits, Amphenol, Glenair.

Сотрудничество с глобальными дистрибьюторами электронных компонентов, предоставляет возможность заказывать и получать с международных складов практически любой перечень компонентов в оптимальные для Вас сроки.

На всех этапах разработки и производства наши партнеры могут получить квалифицированную поддержку опытных инженеров.

Система менеджмента качества компании отвечает требованиям в соответствии с ГОСТ Р ИСО 9001, ГОСТ РВ 0015-002 и ЭС РД 009

Офис по работе с юридическими лицами:

105318, г.Москва, ул.Щербаковская д.3, офис 1107, 1118, ДЦ «Щербаковский»

Телефон: +7 495 668-12-70 (многоканальный)

Факс: +7 495 668-12-70 (доб.304)

E-mail: info@moschip.ru

Skype отдела продаж:

moschip.ru

moschip.ru_4

moschip.ru_6

moschip.ru_9