



opticalCON



NEUTRIK®

Content

PAGE

Introduction	4
Design Criteria	5
Features & Benefits - opticalCON ADVANCED	6
opticalCON DUO	8
Cable Connector Assembly	8
Chassis Connector	8
Custom Entertainment Cables - Hybrid DUO Cable	9
Cables & Applications	9
opticalCON QUAD	10
Cable Connector Assembly	10
Chassis Connector	10
Custom Entertainment Cables - X-TREME / ARMORED Cable	11
Cables & Applications	11
opticalCON MTP®	12
Cable Connector Assembly	12
Chassis Connector	12
MTP® MPO-style Connector	13
Cables & Applications	13
opticalCON SPLIT Cables	14
12 Channel Cable	14
Cables & Applications	14
POWER-SPLIT Cable	15
Cables & Applications	15
Technical Data	16
Cable & Chassis Connectors	16
Mobile Field Cables	17
Ordering Information	18
Mobile Cables	18
Chassis Connectors	22
Coupler	22
Breakout Adapter	22
Transceiver Adapter	23
Accessories	23
Pulling Solutions	23
Fiber Optic Measurement & Cleaning Kit	24
opticalCON Connector Field Assembly	24



photo: Swiss TV



photo: Jaro Hollan



Fiber Optic Accessories	25
Breakout & Panel Solutions	26
Breakout Box	26
19" Z-Panels & Plates	26
opticalCON powerMONITOR	27
powerMONITOR	27
1RU & 3RU 19" Rack Units	27
Breakout Box	27
Ordering Information	28
D-shape Z-panels	28
powerMONITOR	29
Breakout Box	29
Power supply for powerMONITOR	29
opticamSWITCH	30
Applications	31
Audio Application	32
Video/Lighting Application	33
Broadcast Application OB Truck	34
Broadcast Application SNG/ENG	36
Broadcast Application Studio Routing	37
Wiring And Hook Up Suggestion	38
opticalCON DUO Or QUAD?	38
Cable Wiring	38



Introduction

Only a few years ago, the use of fiber optic cabling was limited to such special cases as HD broadcast cameras. Since then, the adoption of fiber optics has increased immensely. Today, fiber optic cables are widely used for digital signal transmission and network applications in the pro audio, broadcast, and touring / rental industries.

THE APPLICATIONS FOR FIBER ARE EXTENSIVE. SOME EXAMPLES ARE:

- Network (audio, data, or DMX) transmissions with >70m (mobile) or >100m (installation) lengths, connected to professional equipment (e.g. mixers) that uses fiber optic connectors or fiber optic switching
- Digital HD video transmissions >15m (e.g. DVI, HDMI, or KVM projection) using fiber optic media converters
- Future-proof installations designed to eliminate bandwidth limitations
- Noise and EMI protection on audio or video (LED wall) applications
- Increased bandwidth, especially for broadcast applications
- Minimized cabling by embedding multiple data signals

As pro audio and broadcast equipment has evolved from analog to digital data transmission, the industry has attempted to adapt connectors originally designed for the data communication and computer industries (e.g. RJ45 connectors). Today, that trend continues with fiber optic connectors. But this is problematic. Conventional data-communication fiber optic connectors (ST, SC, LC, etc.) are optimized for permanent, one-time connection. These connectors were never designed for, and cannot withstand, the rough handling of mobile applications or the multiple mating cycles required in the entertainment industry. Alternative connectors, originally developed for military applications, have not been cost effective and have been deficient either in regards to dust protection and maintenance or attenuation and return loss.



Design Criteria

Neutrik solved the various problems associated with mobile fiber optic connectivity with the launch of the opticalCON DUO fiber optic connection system in 2005. opticalCON's reliable and simple concept, with ruggedness and low maintenance at its core, has gained wide acceptance in the pro audio and broadcast industries. Well-known professional equipment manufacturers as well as key users in broadcast and rental / touring trust in opticalCON. It is our goal to turn opticalCON into an industry standard comparable to the widely used etherCON series.

opticalCON is based on LC-Duplex connectors but eliminates their inherent weaknesses, guaranteeing a safe, dust protected, and ruggedized connection. opticalCON DUO's compatibility with conventional LC connectors at both the front and the rear of the chassis connectors offers users the choice of using cost effective LC cables or ruggedized opticalCON cabling, depending on the requirements at hand. This flexibility to choose cost-effective LC cabling for system integration or ruggedized opticalCON for mobile applications benefits both OEMs and system integrators.

opticalCON DUO is most typically used for equipment connections, including various audio, lighting, and video applications. Typical uses include audio and DMX network (ring switch) applications, video projection based on fiber optic DVI, HDMI, or KVM signal converters, mobile LED panels, and various broadcast applications.

Following on the success of opticalCON DUO, the newer opticalCON QUAD series doubles the fiber count to four per cable and is designed with point-to-point connections in mind. opticalCON QUAD has been successfully deployed in such applications as data routing for touring / rental events and, especially, OB outdoor broadcast applications.

The brand new opticalCON MTP® increases the numbers of fibers in one connector to 12 and is the ideal solution for multi-fiber point-to-point applications as often required for broadcast applications. Alternatively SPLIT cables, assembled with opticalCON DUO or QUAD, support a connector standardization and offers advantages with regard to field assembly or repair costs.

The opticalCON line continues to grow in response to our users' requirements our very successfully X-TREME cable and the brand new ARMORED cable, available for both opticalCON DUO and opticalCON QUAD, provide most possible reliability. A combined opticalCON / powerCON cable provides both multichannel fiber and power. A series of patch panels, couplers, breakout boxes, color-coded springs and gaskets, and on-air powerMONITOR products eases system integration and helps assure flawless operation.

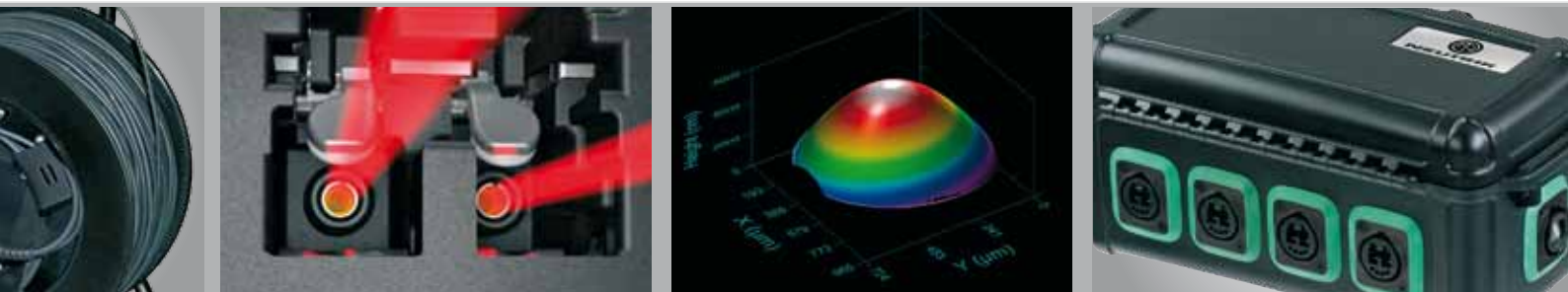

opticalCON ADVANCED

Features & Benefits

- MOBILE USE
- RUGGED
- LOW MAINTENANCE
- SIMPLE INTEGRATION
- COST EFFECTIVE



Lockable, O-ring sealed metal protection cap

Ratched lock bushing

Custom color coding

Protective rubber coating

Ergonomic anti-kink boot for various cable O.D.



opticalCON DUO

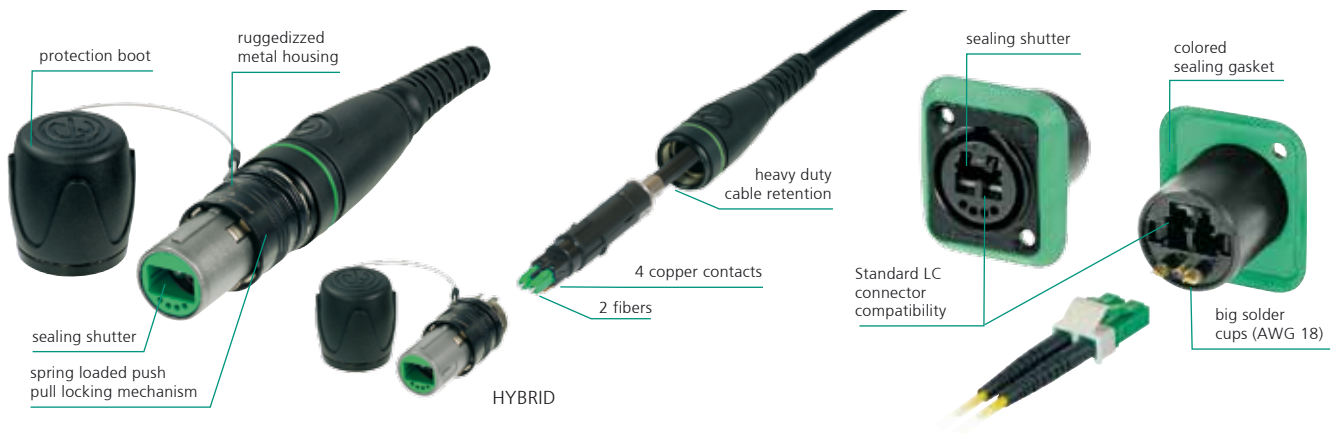

opticalCON QUAD



opticalCON MTP®

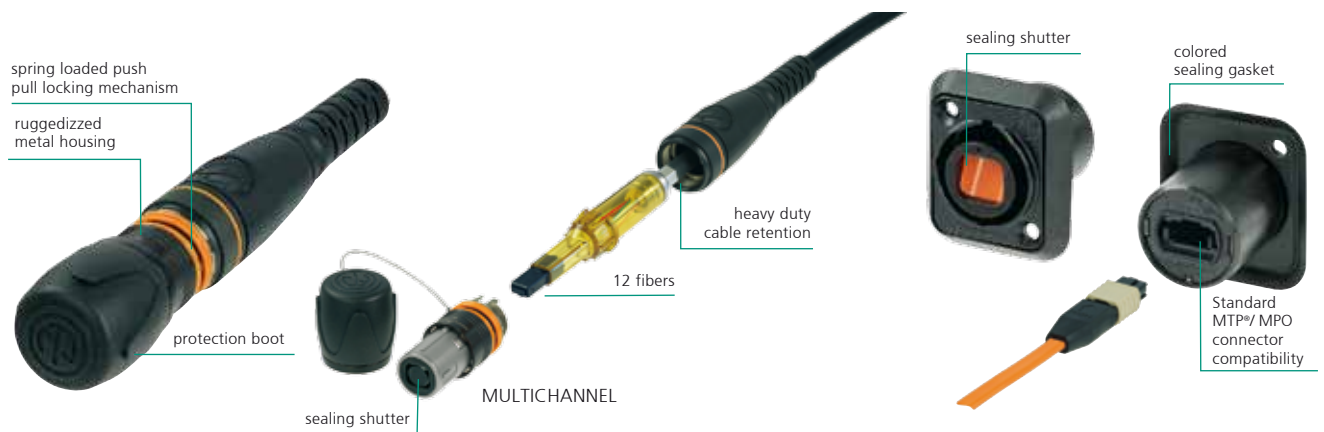

opticalCON DUO

Cable Connector Assembly

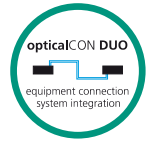

- Ruggedized and dirt-protected 2-channel fiber optic connection system
- Cable connector features rugged all-metal housing and heavy-duty cable retention
- Automatic sealing shutter with silicone gasket
- Dust and water resistant according to IP65 in mated condition
- Accommodates standard optical LC-Duplex connectors
- Field repairable
- Easy to clean, no tools required
- Reliable Push-Pull locking mechanism
- Color-coded cable connector comes pre-assembled with a choice of mobile field cables

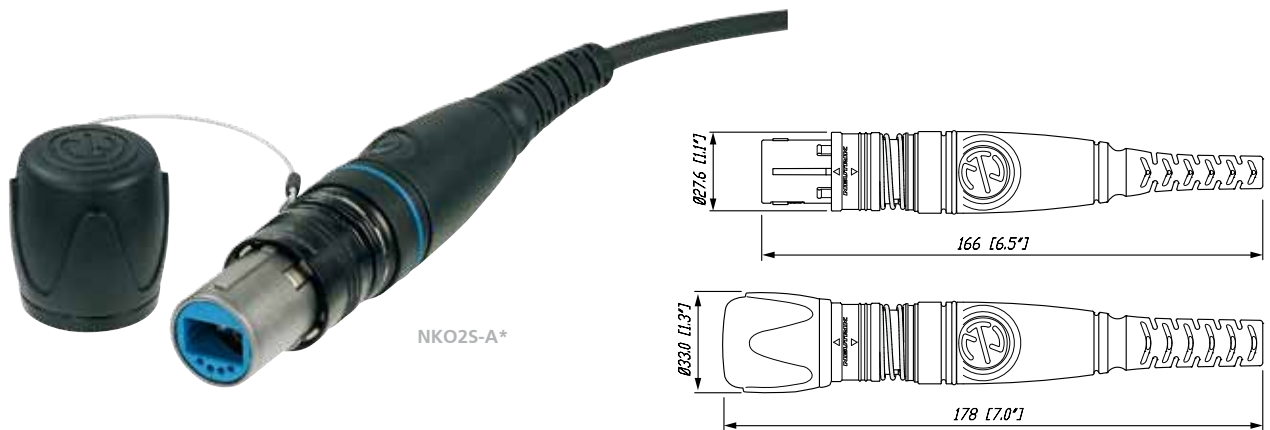

Chassis Connector

- Ruggedized and dirt-protected 2-channel fiber optic connection system
- Shutter with silicon gasket protects optical connection from dust and dirt
- Suggested OEM equipment connectors due to LC front compatibility
- Accommodates standard LC connectors on the rear for simple installation
- Dust and water resistant according to IP65 in mated condition
- Connection on the front side either by rugged opticalCON or standard LC connector
- Color-coded rubber sealing gasket SCDP-* (black, blue, green to identify fiber mode)



NO2-4FDW-A with SCDP-0

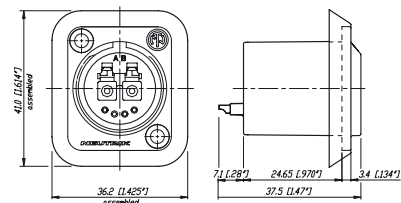

Hybrid DUO Cables













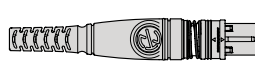

- Range of 3 hybrid cables for powered applications:
 - SMPTE cable for indoor HD camera routing applications ¹
 - Hybrid multimode cable
 - Low voltage camera / SM hybrid cable for ENG/SNG applications

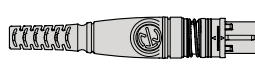
¹ ... Not compatible to SMPTE 304M standard. Suitable for indoor (studio) camera links considering specific conditions acc. to IEC 60664-1 like pollution degree 1, overvoltage category 1 and rated voltage. For detailed information ask for the White Paper "opticalCON @ SMPTE Indoor Applications".

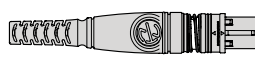

Cables & Applications

The opticalCON DUO is the ideal solution for equipment connections and system integration, offering LC compatibility on both the front and rear of the chassis connector. The wide range of hybrid cables covers the need for powered applications such as camera powering, SNG / ENG applications, etc.

 <p>2M / 2S (A)</p>	<p>opticalCON DUO</p>  <p>Rugged and lightweight 2 channel mobile field cable, excellent cable retention due to aramid yarn, black PUR outer jacket, available in multi- and single mode (PC or APC), military approved.</p>		<div style="display: flex; justify-content: space-around; width: 100%;"> <div style="writing-mode: vertical-rl; transform: rotate(180deg);">BROADCAST</div> <div style="writing-mode: vertical-rl; transform: rotate(180deg);">SYSTEM INTEGRATION (S.I.)</div> <div style="writing-mode: vertical-rl; transform: rotate(180deg);">LIVE / RENTAL</div> <div style="writing-mode: vertical-rl; transform: rotate(180deg);">INDUSTRIAL</div> </div>
 <p>XM / X2S (A)</p>	<p>opticalCON DUO X-TREME</p>  <p>2 channel X-TREME cable offering a cut-proof and rodent resistant double jacket glass yarn armoured cable construction, excellent cable retention due to aramid yarn, black PUR outer jacket.</p>		
 <p>XX2M / XX2S (A)</p>	<p>opticalCON DUO ARMORED</p>  <p>Extra rugged and lightweight stainless steel, jacket absorbs lateral forces up to 2.000 kg. Ultra flexible due to the special spring shape construction, available in multi- and single mode (PC or APC).</p>		
 <p>H1</p>	<p>opticalCON DUO MULTIMODE HYBRID</p>  <p>Extra rugged hybrid cable with 2 multimode channels and 4 x 0.75mm² copper conductors, GFK strength member and aramid yarn as cable retention.</p>		
 <p>S1</p>	<p>opticalCON DUO SMPTE</p>  <p>SMPTE cable with 2 single mode channels (PC or APC), 2 x AWG24 and 2 x AWG16 stranded copper conductors, overall copperbraided shield and stainless steel strength member, 118 kg/km.</p>		
 <p>S5</p>	<p>opticalCON DUO LOW VOLTAGE HYBRID</p>  <p>Ultra flexible, cost effective and lightweight (65 kg/km) low voltage camera / SM hybrid cable with 2 single mode channels and 2 x AWG16 copper conductors, aramid yarn cable retention.</p>		

opticalCON QUAD

Cable Connector Assembly

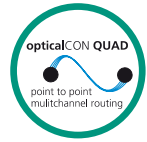

- Ruggedized and dirt-protected 4-channel fiber optic connection system
- For POINT-TO-POINT multichannel routing
- Cable connector features rugged all-metal housing and heavy-duty cable retention
- Innovative spherical shutter guarantees low maintenance
- Dust and water resistant according to IP65 in mated condition
- Easy to clean, no tools required
- Reliable Push-Pull locking mechanism
- Color-coded cable connector comes pre-assembled with a choice of mobile field cables
- Field repairable



NK045-A*

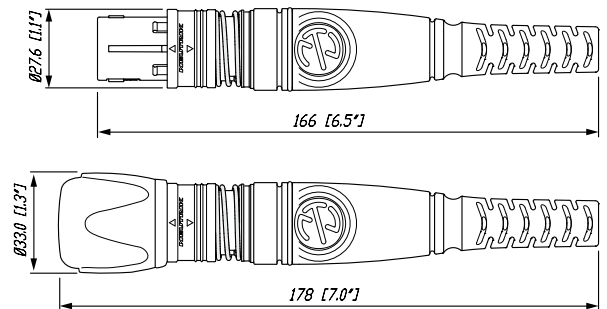

Chassis Connector

- Ruggedized and dirt-protected 4-channel fiber optic connection system
- For POINT-TO-POINT multichannel routing
- Laser protective metal shutter seals dust proof with two-component rubber gasket
- Dust and water resistant according to IP65 in mated condition
- Accommodates standard LC connectors on the rear for simple installation
- Color-coded rubber sealing gasket (black, blue, green to identify fiber mode)



NO4FDW-A with SCDP-0

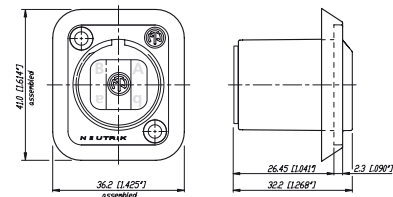

X-TREME / ARMORED Cables

- Up to 12 channel assembly possible (X-TREME)
- opticalCON X-TREME cable for demanding applications like touring / rental or outdoor broadcast
- A cut and rodent-protected double-jacket, glass-yarn armored cable construction
- Available for opticalCON DUO, QUAD and split cables



opticalCON X-TREME



opticalCON ARMORED



Cables & Applications

The opticalCON QUAD is preferably used for POINT-TO-POINT multichannel routing applications.



4M / 4S (A)

opticalCON QUAD



Rugged and lightweight 4 channel mobile field cable, excellent cable retention due to aramid yarn, black PUR outer jacket, available in multi- and single mode (PC or APC).



X4M / X4S (A)

opticalCON QUAD X-TREME



4 channel X-TREME cable offering a cut-proof and rodent resistant double jacket glass yarn armoured cable construction, excellent cable retention due to aramid yarn, black PUR outer jacket.

opticalCON QUAD X-TREME



XX4M / XX4S (A)

opticalCON QUAD ARMORED



Extra rugged and lightweight stainless steel jacket absorbs lateral forces of 200kg/cm². Ultra flexible due to the special spring shape construction, available in multi- and single mode (PC or APC).

opticalCON ARMORED

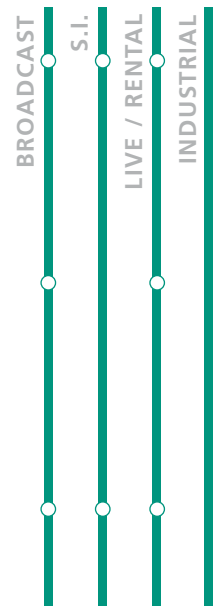

opticalCON MTP® Cable Connector Assembly

NEW

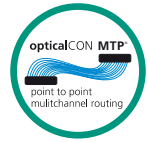

- Ruggedized and dirt-protected 12-channel fiber optic connection system
- For POINT-TO-POINT multichannel routing based on MTP® technology
- Cable connector features rugged all-metal housing and heavy-duty cable retention
- Innovative spherical shutter guarantees low maintenance
- Dust and water resistant according to IP65 in mated condition
- Easy to clean, no tools required
- Reliable Push-Pull locking mechanism
- Color-coded cable connector comes pre-assembled with a choice of mobile field cables

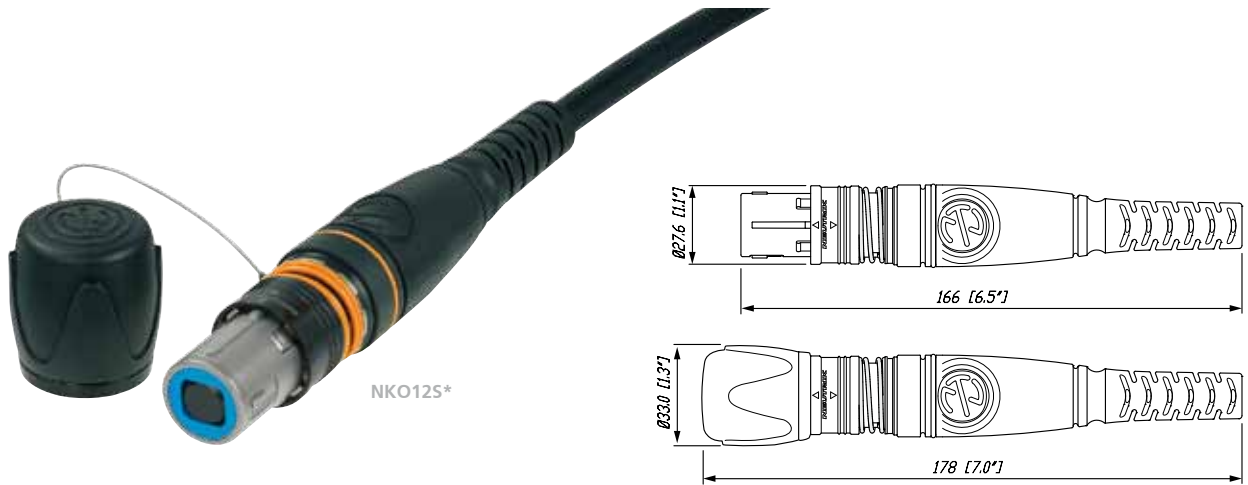

Chassis Connector

- Ruggedized and dirt-protected 12-channel fiber optic connection system
- For POINT-TO-POINT multichannel routing
- Laser protective metal shutter seals dust proof with two-component rubber gasket
- Dust and water resistant according to IP65 in mated condition
- Accommodates standard MTP® / MPO connectors on the rear for simple installation
- Rubber sealing gasket (black, blue, green to identify fiber mode)



NO12FDW-A with SCDP-0

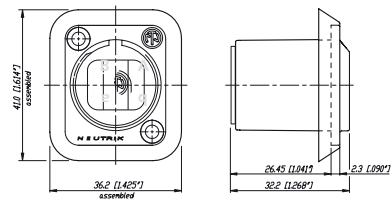

MTP® / MPO-style Connector

The MTP® is a multichannel fiber optic connector based on MPO (“Multifiber Push on”) technology (IEC-61754-7). MTP® connectors are fully compatible to MPO connectors and offer 12 fibers in a very small form factor. Patch- and breakout cables to standard connectors as LC, SC, ST are widely available in specialised shops.

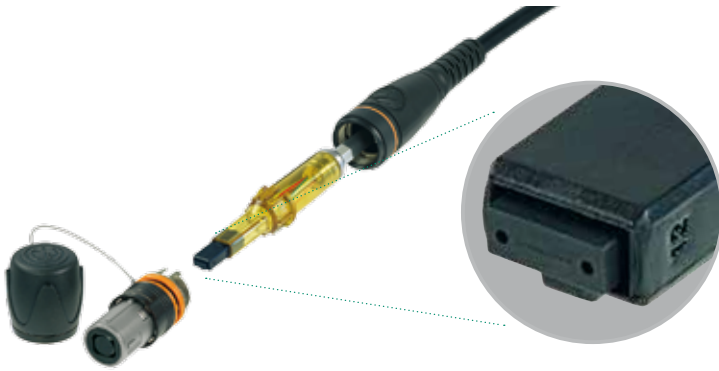







Neutrik opticalCON MTP® / MPO-style connector

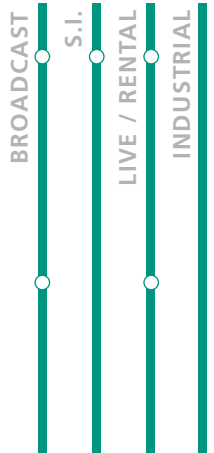

MTP® / MPO breakout cable (LC)
opticalCON MTP®

Cables & Applications

The opticalCON MTP® is preferably used for POINT-TO-POINT multichannel applications. The MTP® 12 channel cables offer a lightweight cable design with a small outer diameter perfect for long cable runs, while the X-TREME cable is custom designed for most demanding applications.

 12M / 12S (A)	<p>opticalCON MTP®</p>  <p>Rugged and lightweight 12 channel mobile field cable, excellent cable retention due to aramid yarn, black PUR outer jacket, available in multi- and single mode (PC or APC).</p>		
 X12M / X12S (A)	<p>opticalCON MTP® X-TREME</p>  <p>12 channel X-TREME cable offering a cut-proof and rodent resistant double jacket glass yarn armoured cable construction, excellent cable retention due to aramid yarn, black PUR outer jacket.</p>		

opticalCON Split Cables

SPLIT Cables

- opticalCON multichannel solution based on opticalCON DUO, QUAD or opticalCON MTP® connectors
- maximum flexibility, combining up to 12 channel cables
- 1m TRIPLE SPLIT: mechanically damaged connectors can be reassembled with a slightly shortened cable split
- Color coding for channel identification

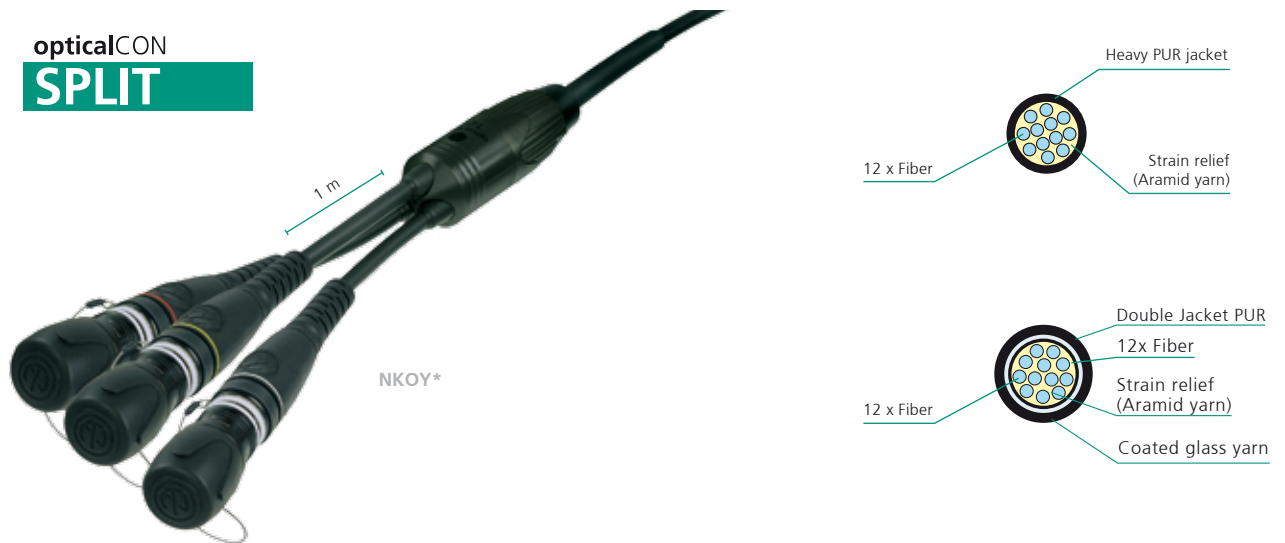

Cables & Applications

The SPLIT cable offers simple installation combined with a flexible connectivity system with up to 12 fibers, while the X-TREME cable is custom designed for most demanding applications.

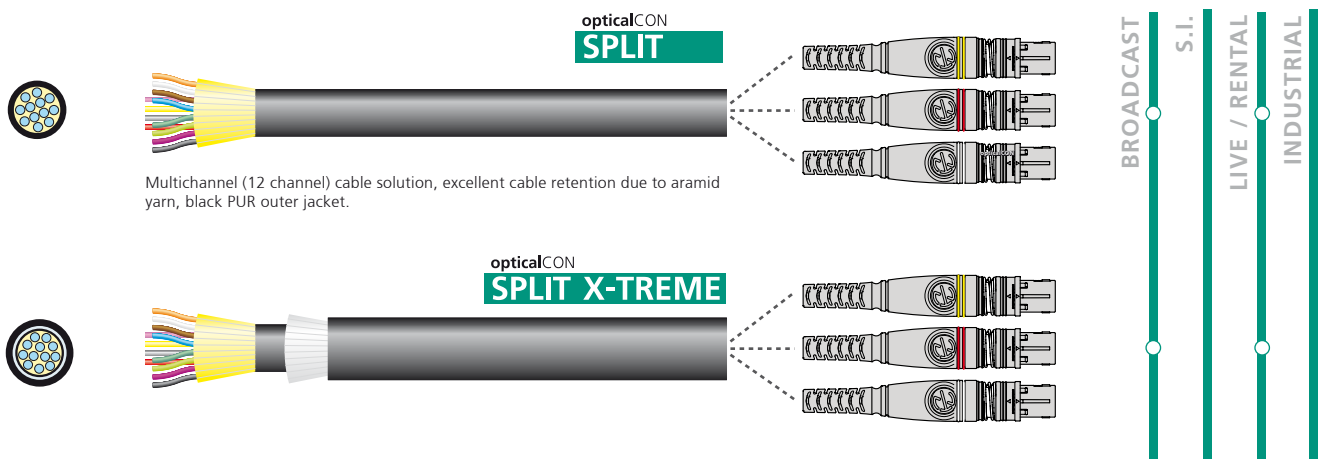

POWER SPLIT Cables

- Hybrid opticalCON / Power (240 Vac / 16A) solution
- 2, 4, 6 and 8 channel assembly available
- Custom made cable, optimized for ENG / SNG applications

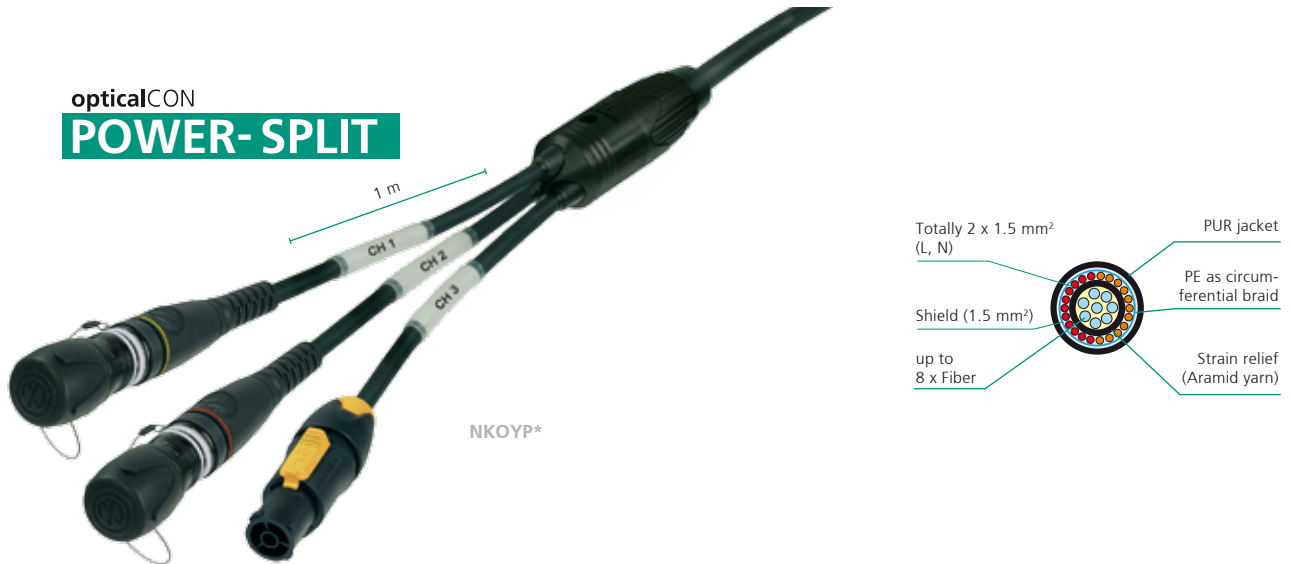

Cables & Applications

The POWER-SPLIT cables combine up to 8 fibres and 240 VAC power in a rugged and very well protectet hybrid cable design.

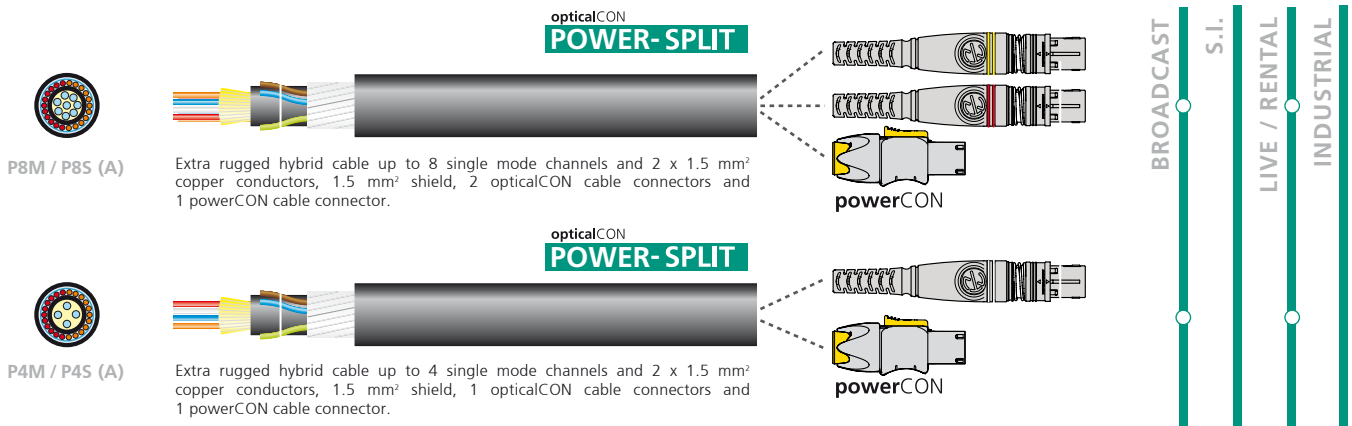

Technical Data

Connectors

	OPTICAL		opticalCON DUO		opticalCON QUAD		opticalCON MTP®	
			Cable	Chassis	Cable	Chassis	Cable	Chassis
Optical connector			LC-Duplex	LC-Duplex Feedthrough	PC	LC-Duplex (rear)		MTP® (rear)
Fiber		Multi mode, Single mode	●	●	●	●	●	●
Insertion loss		< 0.5 dB / connection	●	●	●	●	●	●
min. Return Loss		PC 45 dB	●	●	●	●	●	●
		APC 60 dB	●	●	●	●	●	●
MECHANICAL								
Insertion / withdrawal force		< 45 N	●	●	●	●	●	●
Lifetime (mating cycles)		> 5'000	●	●	●	●	> 2'500	> 2'500
Cable retention force	Fiber only	> 500 N	●	-	●	-	●	-
	Hybrid	> 500 N	●	-	-	-	-	-
	SMPTE	> 350 N	●	-	-	-	-	-
ELECTRICAL								
Number of electrical contacts			4	4 (5)	-	-	-	-
Rated current		6 A	NKO2M-4S75*	●	-	-	-	-
		10 A (contact 1+4)	NKO2S(A)-SMPTE*	●	-	-	-	-
Contact resistance		< 7 mΩ	●	●	-	-	-	-
Insulation resistance	- initial:	> 10 GΩ	●	●	-	-	-	-
	- after damp heat test:	> 1 GΩ	●	●	-	-	-	-
Dielectric strength		1500 V dc	●	●	-	-	-	-
Rated voltage		50 V ac	● ¹	● ¹	-	-	-	-
MATERIAL								
Shell Zinc diecast (ZnAl4Cu1)	(black chrome plating)		●	●	●	●	●	●
Insert / Insulation	Polyamid PA 6, PBT 30% GR, PBT 50% GR		●	●	●	●	●	●
Insert colour	MM: black, SM PC: blue, SM APC: green		●	●	●	●	●	●
Contacts	- male:	Brass (CuZn39Pb3)	●	-	-	-	-	-
	- female:	Bronze (CuSn6)	-	●	-	-	-	-
Contact surface	Gold (gal 0.2 μm Au over 2 μm Ni)		●	●	-	-	-	-
Strain relief	Brass, Ni plated		●	-	●	-	●	-
Bushing	ZnAl4Cu1		●	-	●	-	●	-
Boot	EPDM, rubber boot		●	-	●	-	●	-
Slit sleeve	ceramics		-	●	-	●	-	-
ENVIRONMENTAL								
Operating temperature	-25°C to +75°C	flammability UL94 HB	●	●	●	●	●	●
Solderability	complies with IEC 68-2-20		●	●	-	-	-	-
Protection class in mated condition	IP65		●	●	●	●	●	●

¹... Not compatible to SMPTE 304M standard. Suitable for indoor (studio) camera links considering specific conditions acc. to IEC 60664-1 like pollution degree 1, overvoltage category 1 and rated voltage. For detailed information ask for the White Paper "opticalCON @ SMPTE Indoor Applications".

Cables

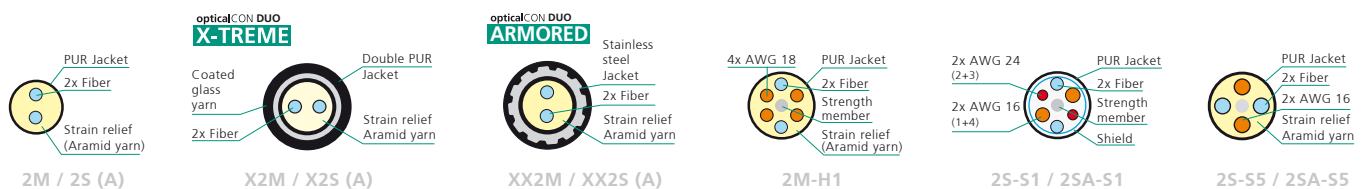

Mobile Field Cables

	Max. numbers of fibers	MODE		FIBER		Bend optimized fiber		Laser optimized fiber		Copper wires			Outer shield			Strength member		Cable retention		Overall diameter (mm)	Jacket	Optical connector		Min. bending radius (cm)	Weight (kg / km)	Attenuation (dB / km)	Bandwidth (MHz-km)	Refraction index	Power solution 240 V ac / 16A
		Multimode PC	Single mode PC / APC	50 / 125-OM3	9 / 125-G657A			AWG 16	AWG 18 (0.75 mm ²)	AWG 24	Copperbraid	Coated glass yarn	Stainless steel Jacket	GFK	Stainless Steel	Aramid yarn	Crimp type	PUR black matte	LC-Duplex			LC based							
2M	2	•	-	•		•	•	-	-	-	-	-	-	-	•	-	•	•	-	5	•	•	-	5	21	@ 850 nm - 3.5 @ 1300 nm - 1.5	@ 850 nm >1500 @ 1300 nm >500	@ 850 nm - 1.483 @ 1300 nm - 1.479	-
2S (A)	2	-	•	-	•	•	N/A	-	-	-	-	-	-	-	•	-	•	•	-	5	•	•	-	5	23	@ 1310 nm - 0.5 @ 1550 nm - 0.5		@ 1310 nm - 1.458 @ 1550 nm - 1.458	-
2M-H1	2	•	-	OM2	-	-	-	-	-	4x	-	-	-	-	•	-	•	•	-	8.9	•	•	-	8.9	78	@ 850 nm - 2.5 @ 1300 nm - 0.7	@ 850 nm - 500 @ 1300 nm - 500	@ 850 nm - 1.482 @ 1300 nm - 1.477	-
S1	2	-	•	-	•	•	N/A	2x	-	2x	•	-	-	-	•	-	•	•	-	9.2	•	•	-	10	118	@ 1310 nm - 0.45 @ 1550 nm - 0.5		@ 1310 nm - 1.468 @ 1550 nm - 1.468	-
S5	2	-	•	-	•	•	N/A	2x	-	-	-	-	-	-	•	-	•	•	-	7.5	•	•	-	7.5	65	@ 1310 nm - 0.5 @ 1550 nm - 0.5		@ 1310 nm - 1.458 @ 1550 nm - 1.458	-
4M	4	•	-	•	-	•	•	-	-	-	-	-	-	-	•	-	•	•	-	5.8	•	-	•	5.8	31	@ 850 nm - 2.5 @ 1300 nm - 0.5	@ 850 nm ≥1500 @ 1300 nm ≥500	@ 850 nm - 1.482 @ 1300 nm - 1.477	-
4S (A)	4	-	•	-	•	•	N/A	-	-	-	-	-	-	-	•	-	•	•	-	5.8	•	-	•	5.8	31	@ 1310 nm - 0.35 @ 1550 nm - 0.21		@ 1310 nm - 1.467 @ 1550 nm - 1.467	-
X2M	2	•	-	•	-	•	•	-	-	-	-	-	-	-	•	-	•	•	-	8.5	•	•	-	8.5	79	@ 850 nm - 2.5 @ 1300 nm - 0.5	@ 850 nm ≥1500 @ 1300 nm ≥500	@ 850 nm - 1.482 @ 1300 nm - 1.477	-
X2S	2	-	•	-	•	•	N/A	-	-	-	-	-	-	-	•	-	•	•	-	8.5	•	-	•	8.5	79	@ 1310 nm - 0.35 @ 1550 nm - 0.21		@ 1310 nm - 1.467 @ 1550 nm - 1.467	-
XX2M	2	•	-	•	-	•	•	-	-	-	-	-	-	-	•	-	•	•	-	10.5	•	-	•	10.5	131	@ 850 nm - 3.5 @ 1300 nm - 1.5	@ 850 nm ≥1500 @ 1300 nm ≥500	@ 850 nm - 1.483 @ 1300 nm - 1.479	-
XX2S	2	-	•	-	•	•	N/A	-	-	-	-	-	-	-	•	-	•	•	-	10.5	•	-	•	10.5	133	@ 1310 nm - 0.5 @ 1550 nm - 0.5		@ 1310 nm - 1.458 @ 1550 nm - 1.458	-
X4M	4	•	-	•	-	•	•	-	-	-	-	-	-	-	•	-	•	•	-	8.5	•	-	•	8.5	79	@ 850 nm - 2.5 @ 1300 nm - 0.5	@ 850 nm ≥1500 @ 1300 nm ≥500	@ 850 nm - 1.482 @ 1300 nm - 1.477	-
X4S	4	-	•	-	•	•	N/A	-	-	-	-	-	-	-	•	-	•	•	-	8.5	•	-	•	8.5	79	@ 1310 nm - 0.35 @ 1550 nm - 0.21		@ 1310 nm - 1.467 @ 1550 nm - 1.467	-
XX4M	4	•	-	•	-	•	•	-	-	-	-	-	-	-	•	-	•	•	-	10.5	•	-	•	10.5	141	@ 850 nm - 2.5 @ 1300 nm - 0.5	@ 850 nm ≥1500 @ 1300 nm ≥500	@ 850 nm - 1.482 @ 1300 nm - 1.477	-
XX4S	4	-	•	-	•	•	N/A	-	-	-	-	-	-	-	•	-	•	•	-	10.5	•	-	•	10.5	141	@ 1310 nm - 0.35 @ 1550 nm - 0.21		@ 1310 nm - 1.467 @ 1550 nm - 1.467	-
12M	12	•	-	•	-	•	•	-	-	-	-	-	-	-	•	-	•	•	-	8.2	•	-	•	8.2	76	@ 850 nm - 2.5 @ 1300 nm - 0.5	@ 850 nm ≥1500 @ 1300 nm ≥500	@ 850 nm - 1.482 @ 1300 nm - 1.477	-
12S (A)	12	-	•	-	•	•	N/A	-	-	-	-	-	-	-	•	-	•	•	-	8.2	•	-	•	8.2	76	@ 1310 nm - 0.5 @ 1550 nm - 0.3		@ 1310 nm - 1.467 @ 1550 nm - 1.467	-
X12M	12	•	-	•	-	•	•	-	-	-	-	-	-	-	•	-	•	•	-	10.9	•	•	•	10.9	126	@ 850 nm - 2.5 @ 1300 nm - 0.5	@ 850 nm ≥1500 @ 1300 nm ≥500	@ 850 nm - 1.482 @ 1300 nm - 1.477	-
X12S (A)	12	-	•	-	•	•	N/A	-	-	-	-	-	-	-	•	-	•	•	-	10.9	•	•	•	10.9	126	@ 1310 nm - 0.5 @ 1550 nm - 0.3		@ 1310 nm - 1.467 @ 1550 nm - 1.467	-
P8M	8	•	-	•	-	•	•	3 x 1.5 mm ²	•	-	-	-	-	-	•	-	•	•	-	11.7	•	•	•	11.7	138	@ 850 nm ≤ 2.3 @ 1300 nm ≤ 0.6	@ 850 nm ≥1500 @ 1300 nm ≥500	@ 850 nm - 1.482 @ 1300 nm - 1.477	•*
P8S (A)	8	-	•	-	•	•	N/A	3 x 1.5 mm ²	•	-	-	-	-	-	•	-	•	•	-	11.7	•	•	•	11.7	138	@ 1310 nm ≤ 0.33 @ 1550 nm ≤ 0.19		@ 1310 nm - 1.467 @ 1550 nm - 1.467	•*

* Cable must be unreeled completely before use!

Cables

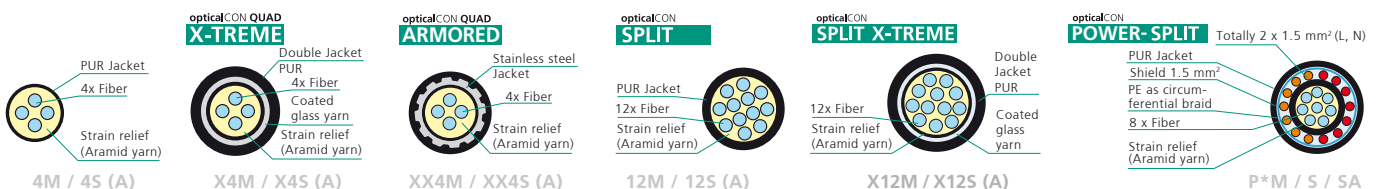

Ordering Information

Mobile Cables

Connect System

Cable

opticalCON DUO

NKO2*



Multimode

2M
X2M
XX2M
2M-H1

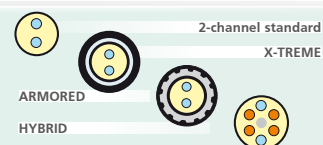

Single mode

2S (A)
X2S (A)
XX2S
2S (A) - S1
2S (A) - S5

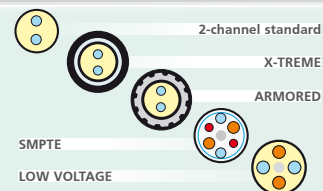

opticalCON QUAD

NKO4*



Multimode

4M
X4M
XX4M



Single mode

4S (A)
X4S (A)
XX4S (A)

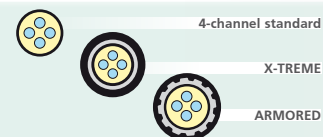

opticalCON MTP®

NKO12*



Multimode

12M
X12M



Single mode

12S (A)
X12S (A)

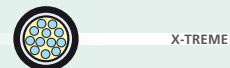

opticalCON SPLIT

NKOY*

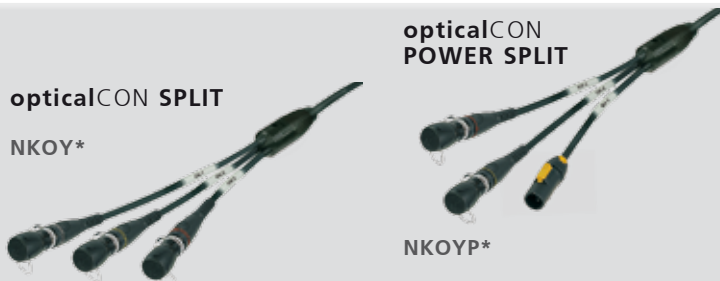

opticalCON
POWER SPLIT

NKOYP*

Multimode

YPM



Single mode

YPS (A)

Multimode

YM
YXM

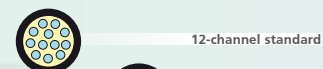

Single mode

YS (A)
YXS (A)

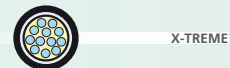

Find the free Download of opticalCON part number generator on www.neutrik.com section „opticalCON“.

Packaging



0 ... Airspool 1 ... opticalCON Case 2 ... Drum Schill GT310 3 ... Drum Schill GT380 4 ... Drum Schill HT582 5 ... Drum Schill GT450

Cable length [m] for Packaging ...

0	1	2	3	4	5
< 2000	< 30	< 200	< 400	< 1000	< 500
< 2000	< 30	-	< 100	< 300	< 150
< 100	< 30	-	< 75	-	< 100
< 2000	< 30	-	< 125	< 300	< 150
< 2000	< 30	< 200	< 400	< 1000	< 500
< 2000	< 30	-	< 100	< 300	< 150
< 100	< 30	-	< 75	-	< 100
< 2000	< 30	-	< 100	< 300	< 150
< 2000	< 30	-	< 150	< 500	< 250
< 2000	< 30	< 150	< 300	< 800	< 400
< 2000	< 30	-	< 100	< 300	< 150
< 100	< 30	-	< 75	-	< 100
< 2000	< 30	< 150	< 300	< 800	< 400
< 2000	< 30	-	< 100	< 300	< 150
< 100	< 30	-	< 75	-	< 100
< 2000	-	< 75	< 125	< 400	< 200
< 2000	-	-	-	< 200	< 100
< 2000	-	< 75	< 125	< 400	< 200
< 2000	-	-	-	< 200	< 100
< 2000	-	-	- *	< 200	< 100
< 2000	-	-	- *	< 200	< 100
< 2000	-	-	- *	< 400	< 200
< 2000	-	-	-	< 200	< 100
< 2000	-	-	- *	< 400	< 200
< 2000	-	-	-	< 200	< 100

Ordering example:

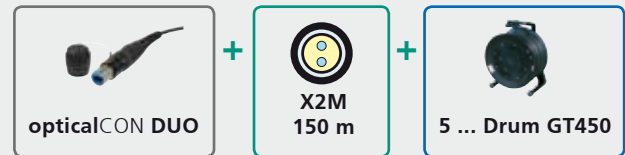

N K O X 2 M - A - 5 - 1 5 0

Neutrik opticalCON cable
Connector / cable type
Length
Packaging
Advanced

Ordering example SPLIT Cables:

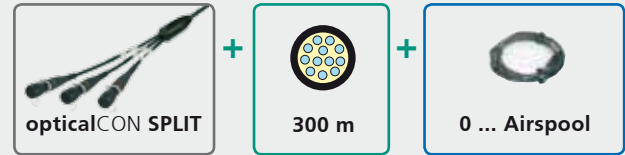

N K O Y M - 0 1 - A - 0 - 3 0 0

Neutrik opticalCON cable
Cable type
Length
Packaging
Advanced

SPLIT CODE

CODE	Combination	CODE	Combination	CODE	Combination	CODE	Combination
01	QQQ - QQQ	11	QQ - QQ	21	QQP - QQP	31	M - QQQ
02	QQD - QQD	12	QD - QD	22	QDP - QDP		
03	QDD - QDD	13	DD - DD	23	DDP - DDP		
04	DDD - DDD	14	Q - DD	24	QP - QP		
				25	QP - DDP		
				26	DP - DP		

D ... DUO; Q ... QUAD; P ... powerCON; M ... MTP*

* ... DUO-SPLIT on request

Ordering Information

Mobile Cables

Custom Cable Assembly Attributes

Custom color coding

0... black	5... green
1... brown	6... blue
2... red	7... violet
3... orange	8... grey
4... yellow	9... white

Breakout assembly

Crossed fiber wiring (A-A, B-B)

Neutrik standard: wiring acc. IEC 11801

Gray coding ring

Custom cable labeling

1 or 2 lines (max. 18 characters)

Female assembly on cable drums

Cable extension solution eliminating the need for couplers.

Attributes

X	Crossed fiber wiring A-A, B-B	T [L1, L2]	Custom cable labeling
F	Female drum assembly, only packaging -2 to -5	H	translucent heat sink
C []	Connector color coding (0-9)	BO []	Breakout assembly (LC, SC, ST)

Ordering Example

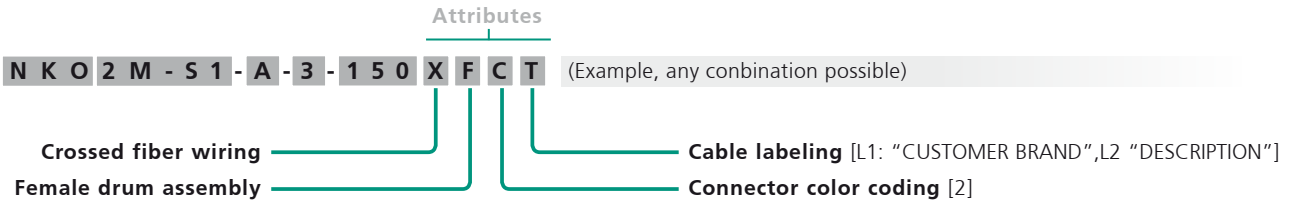

Mobile Cables

Custom Cable Assembly Attributes for Split Cables

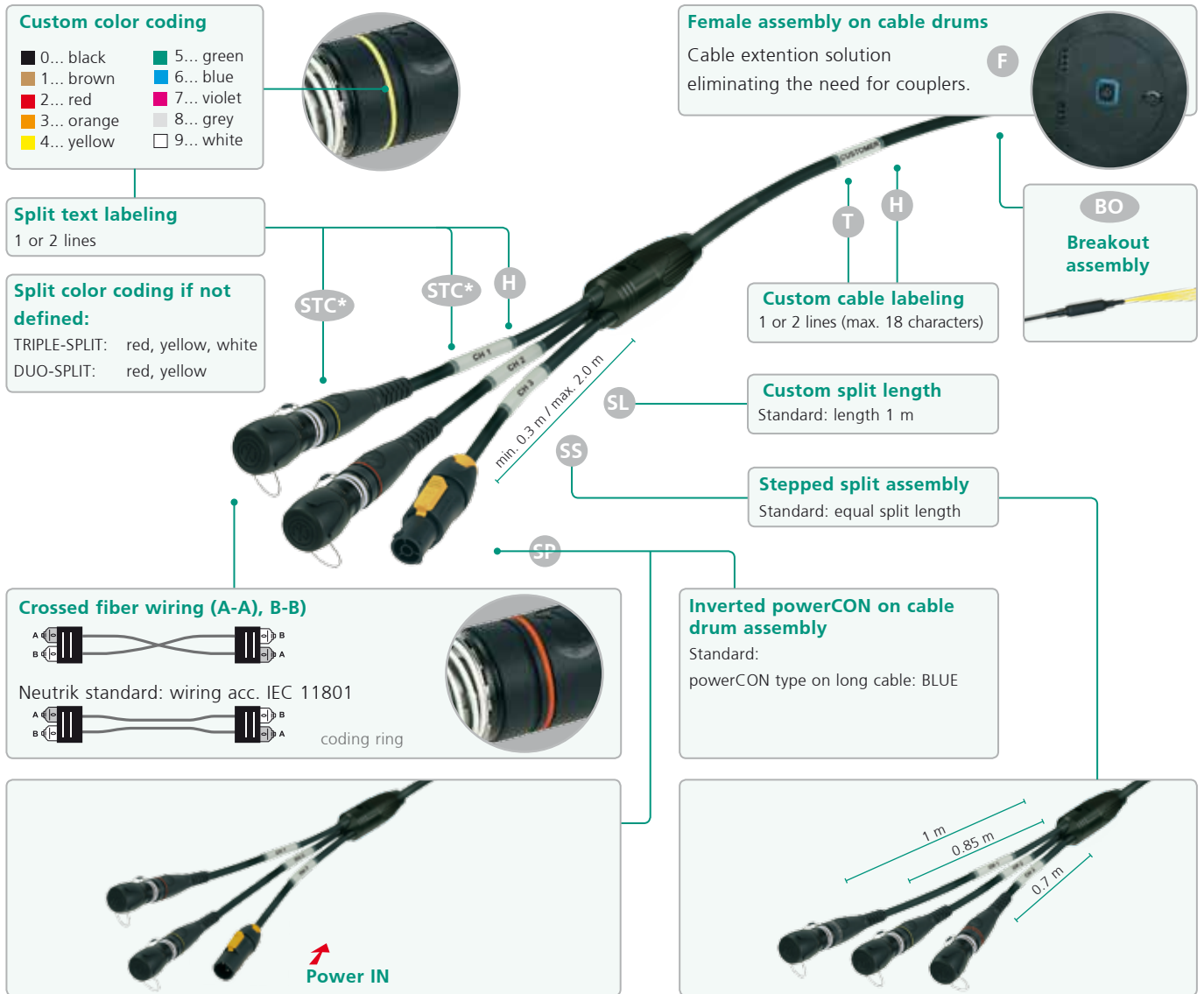

Attributes for Split Cables

X	crossed wired fibers A-A, B-B	SS	stepped split assembly
F	female drum assembly, only packaging -2 to -5	SL []	split length in meter
T [L1, L2]	custom cable labeling	SP	inverted powerCON IN/OUT, only packaging -2 to -5
H	translucent heat shrink	BO []	Breakout assembly (LC, SC, ST)
STC* [L1 " "; L2 " "]	split text to color (0-9)		

Ordering Examples

Attributes

N K O Y S - 0 5 - 3 - 1 5 0 S L S T C 2 S T C 4 T

Ordering Examples for cable show above

N K O Y S - 0 5 - A - 3 - 1 5 0 S L [1 . 5] T [L 1 : " C U S T O M E R "] S T C 2 [L 1 : " C H 1 "] S T C 4 [L 1 : " C H 2 "]

Ordering Information

Chassis Connectors & Breakout Adapter

CHASSIS



NO2-4FDW-A



NO4FDW-A

NEW



NO12FDW-A

	Type	Colour	Plating	Fiber	Solder contacts	Shell ground contact	Wiring
NO2-4FDW-A	Chassis	¹⁾	Black Chrome	2	4	-	-
NO2-4FDW-1-A	Chassis	¹⁾	Black Chrome	2	4	1	-
NO4FDW-A	Chassis	¹⁾	Black Chrome	4	-	-	-
NO12FDW-A	Chassis	¹⁾	Black Chrome	12	-	-	-

¹⁾ ... Coloured labeling to indicate the fiber mode included (black: M, blue: SM PC, green: SM APC)

COUPLER



NAO2S-H1W-A



NAO4MW-A



NAO4MW-A X ²⁾

NEW



NAO12MW-A

	Type	Colour	Plating	Fiber	Solder contacts	Shell ground contact	Wiring
NAO2M-H1W-A ²⁾	Coupler	black	black	2 x LC-Duplex Multimode PC	4 x 0.75 mm ²	-	
NAO2S-H1W-A ²⁾	Coupler	blue	black	2 x LC-Duplex Single mode PC	4 x 0.75 mm ²	-	
NAO2SA-H1W-A ²⁾	Coupler	green	black	2 x LC-Duplex Single mode APC	4 x 0.75 mm ²	-	
NAO4MW-A ²⁾	Coupler	black	black	4 x Multimode PC	-	-	
NAO4SW-A ²⁾	Coupler	blue	black	4 x Single mode PC	-	-	
NAO4SAW-A ²⁾	Coupler	green	black	4 x Single mode APC	-	-	
NAO12MW-A	Coupler	black	black				
NAO12SA-A	Coupler	blue	black				

²⁾ ... add attribute X for crossed fiber wiring

NAOBO – Breakout Adapter

- Flexible chassis mounting solution
- Adaption solution to meet existing non-opticalCON fiber installation



NAOBO (KIT)

Application example



Transceiver Adapter & Accessories

TRANSCEIVER ADAPTER



NAO2M-SFP-LC	grey	MM Transceiver Adapter + opticalCON chassis (NO2-4FDWR) without copper contacts
NAO2S-SFP-LC	blue	SM Transceiver Adapter + opticalCON chassis (NO2-4FDWR) without copper contacts
NAO2SA-SFP-LC	green	SM APC Transceiver Adapter + opticalCON chassis (NO2-4FDWR) without copper contacts

ACCESSORIES



SCNO-FDW-A	Rugged sealing cover for opticalCON chassis connectors
SCNO*X-R ¹⁾	Rubber coated cable connector cover including front housing
SCDP-*	D-Size sealing gaskets for chassis color coding
NOR-*	Color coding ring for cable connector chassis
SCDR	Rear end protection cover for D-size chassis connectors
SCDX	Hinged cover seals D-size chassis connectors, IP42 rated
NAO4ML-R	opticalCON QUAD LOOP connector, multimode
NAO4SL-R	opticalCON QUAD LOOP connector, single mode

*: 0- black, 2- red, 4- yellow, 5- green, 6- blue, 9- white ¹⁾: find part numbers on www.neutrik.com

Advanced Pulling Solutions

- Pulling sock simplifies installation
- Pulling force > 100 kg
- Protects connectors in mated / unmated condition



FOPS-SPLIT	Split cable pulling sock
FOPS-SINGLE	Single cable pulling sock for DUO / QUAD or MTP® cables.

Ordering Information

Fiber Optic Measurement & Cleaning Kit



CAS-FOCD



FOCD-CF

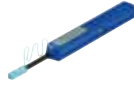

FOCD-DC125/250



CAS-FOMD



FOMD-TC-SM1550



FOMD-FM-MM

CAS-FOCD	Fiber Optic Cleaning Devices - CASE contains hand microscope, opticalCON measurement adapter, cleaning set	
	FOCD-CF ¹⁾	Cleaning Fluid
	FOCD-DC125 ¹⁾	DRY Cleaner 1.25 mm
	FOCD-DC250 ¹⁾	DRY Cleaner 2.5 mm
	FOCD-DW ¹⁾	Lint-free dry wipes for fiber cleaning
CAS-FOMD	Fiber Optic Measurement Devices - CASE contains power source frame, 1.25 mm adapter and multimode attenuator	
	FOMD-TC-MM850 ²⁾	Transceiver 850 nm multimode
	FOMD-TC-SM1310 ²⁾	Transceiver 1310 nm single mode
	FOMD-TC-SM1550 ²⁾	Transceiver 1550 nm single mode
	FOMD-FM-MM ²⁾	Fiber meter multimode
	FOMD-FM-SM ²⁾	Fiber meter single mode

¹⁾ ... refill consumable, in CAS-FOCD included

²⁾ ... combine with CAS-FOMD

opticalCON Connector Field Assembly

- Neutrik opticalCON field assembly kit
- Based on Corning UniCam pre-polished LC connectors
- No additional tooling required
- Requires completion of a certified Neutrik opticalCON field assembly training
- Find more details on www.neutrik.com



opticalCON connector Field assembly

- Field Assembly option now also available with fusion splice technology (fusion splice machine not included)





Fiber Optic Accessories



Breakout & Panel Solutions

Breakout Box

- The breakout boxes are used to split a 4-channel point-to-point opticalCON QUAD connection to either 2 dual channels or 4 single channels based on the opticalCON DUO
- Dust and waterproof according to IP65 in mated condition



NO4SABB4D-A

19" Z-Panels & Plates

- Space saving design, ideal for cramped rack applications such as OB truck I/O panels
- Frame plate can be loaded with opticalCON DUO or QUAD and E2000 or ST or SC
- Frames can be equipped with frame plates (D-shape) or blind plates
- Best cable bend protection
- 1 RU or 3 RU frame

NZPF1RU



NZPF3RU

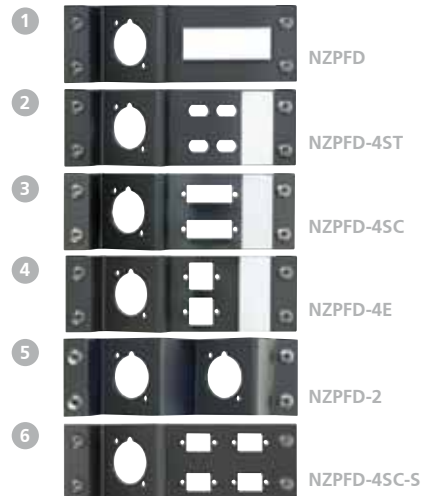
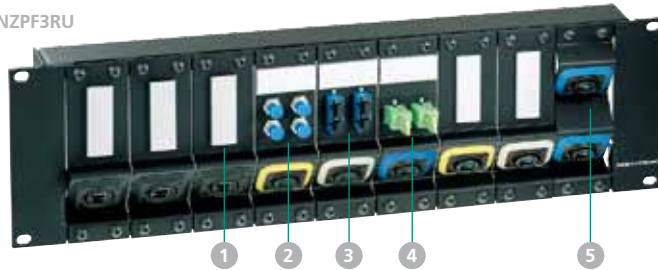

Application Example:

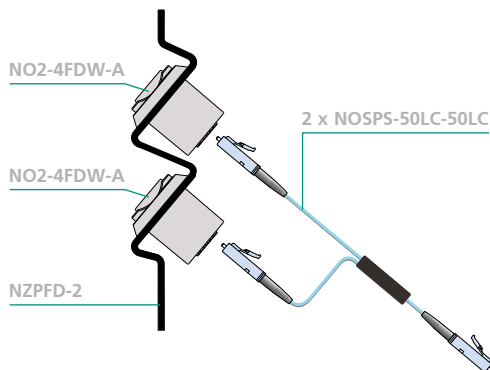

opticalCON powerMONITOR

On air monitoring of fiber optic transmission quality

The opticalCON powerMONITOR is a cost-saving, purpose-built measurement (monitoring) device for professional fiber optic broadcast, audio and video applications.

With simultaneous monitoring of attenuation for up to 4 transmission channels, powerMONITOR provides an immediate, "on air" view into fiber optic signal strength. Visual and audible alarms can be set individually for each fiber channel, based on each channel's power budget. powerMONITOR provides clear status information, delivers early warnings for potential problems, and assists with maintenance scheduling.

- On-air monitoring of fiber optic transmission quality
- Simultaneous power measurement (+0.0/-0.1dB measurement accuracy) of up to 4 channels
- Programmable threshold alarms
- Rack mount and mobile units
- Operates on rechargeable battery power or on mains power with fail-safe battery backup in case of unexpected mains power interruption
- Low loss (0.5dB maximum split loss)
- Wavelength selectable: multimode 850 nm or 1300 nm, single mode 1310 nm, 1550 nm or WDM (wave division multiplexing)

powerMONITOR



NO4S-4F-2R-PM



1 RU & 3 RU 19" Rack units



NO4S-4F-2R-PM (up to two power Monitors)



up to 9 power Monitors

Breakout Box



NO4SBB4D-A

Ordering Information

D-Shape Z-Panels

Z-Panels

Panel frame 1RU

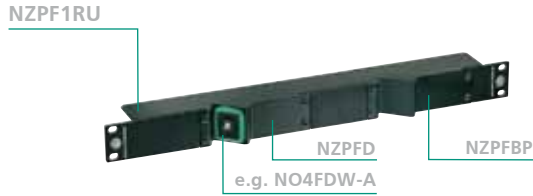

Panel frame 3RU

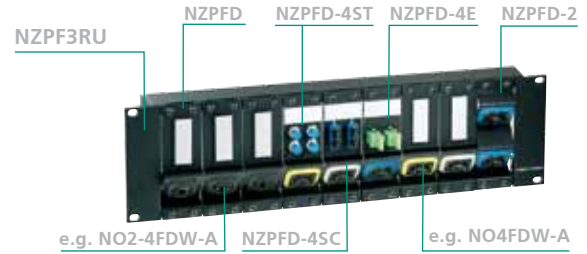

Angled rack panel



NOSPS-50LC-50LC



NZPF1RU	Panel frame 1RU opticalCON
NZPF3RU	Panel frame 3RU opticalCON
NZP1RU-8	Panel 1RU, 8 D size cutouts
NZPFD	Panel frame plate opticalCON
NZPFBP	Panel frame blind plate
NZPFD-2	Panel frame plate 2 D size cutouts
NZPFD-4E	Panel frame plate 1 D size cutout, 2 E2000 compact chassis cutouts
NZPFD-4SC	Panel frame plate 1 D size cutout, 2 SC compact chassis cutouts
NZPFD-4ST	Panel frame plate 1 D size cutout, 4 ST chassis cutouts
NZPFD-4CS-S	Panel frame plate 1 D size cutout, 4 SC simplex cutouts
NOSPM-LC50-LC50	Multimode 1 x 2 splitter LC*
NOSPS-LC50-LC50	Single mode PC 1 x 2 splitter LC*

* ... other connectors (SC, ST, E200) on request

Drawing

Panel frame 1RU

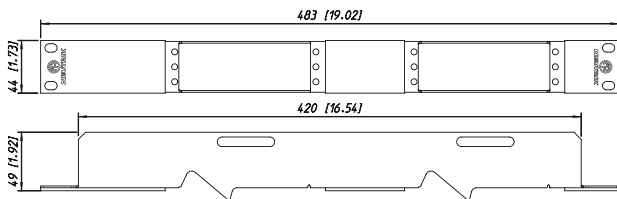

Panel frame 3RU

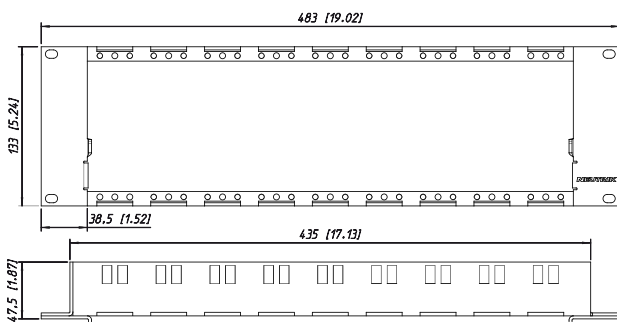

Powermonitor

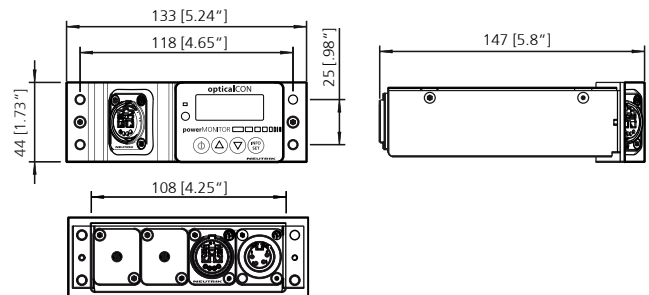

Breakout Box

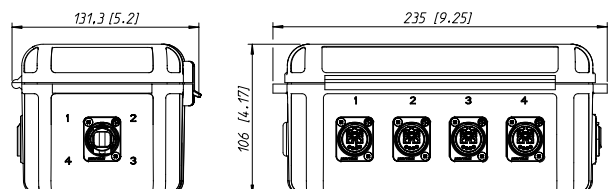

Ordering Information

powerMONITOR & Breakout Box

POWERMONITOR

NO2S - 2F - 2R PM - A ¹⁾

Neutrik opticalCON	Channel	Mode	Chassis Front	Chassis Rear	power MONITOR
	2	S	2F (DUO)	2R (DUO)	PM
		SA			
4	M	4F (QUAD)	4R (QUAD)		



Front view: e.g. 4F (opticalCON QUAD)



Rear view: e.g. 2R (opticalCON DUO)

¹⁾ ... add attribute X for crossed fiber wiring



BREAKOUT BOX



NO4SBB4D-A



NO4SABB4D-A

NO4SBB2D-A ¹⁾	1 x NO4FDW-A to 2 x NO2-4FDW-A, Single mode PC
NO4SABB2D-A ¹⁾	1 x NO4FDW-A to 2 x NO2-4FDW-A, Single mode APC
NO4MBB2D-A ¹⁾	1 x NO4FDW-A to 2 x NO2-4FDW-A, Multimode PC
NO4SBB4D-A	1 x NO4FDW-A to 4 x NO2-4FDW-A, Single mode PC
NO4SABB4D-A	1 x NO4FDW-A to 4 x NO2-4FDW-A, Single mode APC
NO4MBB4D-A	1 x NO4FDW-A to 4 x NO2-4FDW-A, Multimode PC
NO12SABB6D-A	1 x NO4FDW-A to 6 x NO2-4FDW-A, Single mode APC
NO12MBB6D-A	1 x NO4FDW-A to 6 x NO2-4FDW-A, Multimode PC
NO12SABB3Q-A	1 x NO4FDW-A to 3 x NO4FDW-A, Single mode APC
NO12MBB3Q-A	1 x NO4FDW-A to 3 x NO4FDW-A, Multimode PC

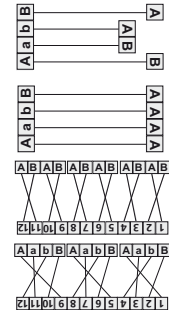

ACCESSORIES

SCNO-FDW-A	Rugged sealing cover for opticalCON chassis connectors (see page 23)
------------	--

Breakout Box with powerMONITOR

NO*BB1*-PM-A ¹⁾	breakout box equipped with opticalCON powerMONITOR ¹⁾ ... add attribute X for crossed fiber wiring
----------------------------	--



POWER SUPPLY FOR POWERMONITOR



NOPS-1RU-PM



NOPS-3RU-PM



NOPS-E-PM

NOPS-1RU-PM	opticalCON powerMONITOR 5W Power Supply, powers up to 2 power monitors, Intern. AC plugs included
NOPS-3RU-PM	opticalCON powerMONITOR 15W Power Supply, 1 + 3RU use, powers up to 9 power monitors, IEC power socket
NOPS-E-PM	opticalCON powerMONITOR, power supply extension cable to daisy-chain power

opticamSWITCH

Ultimate solution for fiber optic camera routing

The opticamSWITCH is the ultimate solution for fiber optic camera routing within broadcast studios. The device allows switching of unlimited camera positions between several studios and control rooms, eliminating the need for high-maintenance, risky matrix patch fields using SMPTE patch cables. The device works on trendsetting, silica-based PLC (planar lightwave circuits) equipped with TO (thermo optic) switches. The innovative design guarantees rugged and safe non-blocking fiber plus camera power switching without any moving parts. The LAN-based remote control software simplifies work, shows switching and camera status, and enables broadcast production automation.

- Thermo Optic PLC Switch
- Non Blocking Structure
- Intelligent Power Working Circuit
- LAN Remote Control
- 19" x 1RU Rack unit



opticamSWITCH front

Rear side with opticalCON chassis or Wieland connectors.





Applications



Applications

Audio

CLAIR BROTHERS, USA

Clair Brothers uses the opticalCON fiber systems for audio signal transmission worldwide as the standard 100 meter runs on all of their high end digital mixing console systems. They also use opticalCON fiber systems under extremely harsh outdoor conditions to distribute digital audio between delay systems (loudspeaker delay) on their larger outdoor festival situations in the US and Europe.

The inherent bulk of the opticalCON system works far better for Clair than previous lightweight fiber systems as it lays flatter and is less susceptible to kinks and being caught up under chairs and stairways in typical arena situations.

Clair Brothers is the world's largest touring company specialized in sound and staging. Through the years Clair Brothers has handled shows for some of the biggest names in the music industry, with artists such as The Eagles, AC/DC, Jonas Brothers and Sir Elton John to name a few. In January of 2009, Clair Brothers was responsible for the post inauguration event for US President Obama, where many thousands of people gathered to hear him speak in a large outdoor event.

»THE CONNECTORS HAVE PROVEN TO BE VERY RELIABLE COMPARED TO PREVIOUS DESIGNS WE HAVE TRIED IN THE PAST. IN FACT ONE SYSTEM PERFECTLY SURVIVED A TORNADO IN ITALY AT AN OUT-DOOR SHOW.«

Howard Page, senior director of engineering, Clair Brothers



Equipment connection
opticalCON DUO



opticalCON DUO
1 RU Panel + powerMONITOR



X-treme cable, ultra robust,
double jacket, cut proof



opticalCON QUAD
Point-to-Point connection

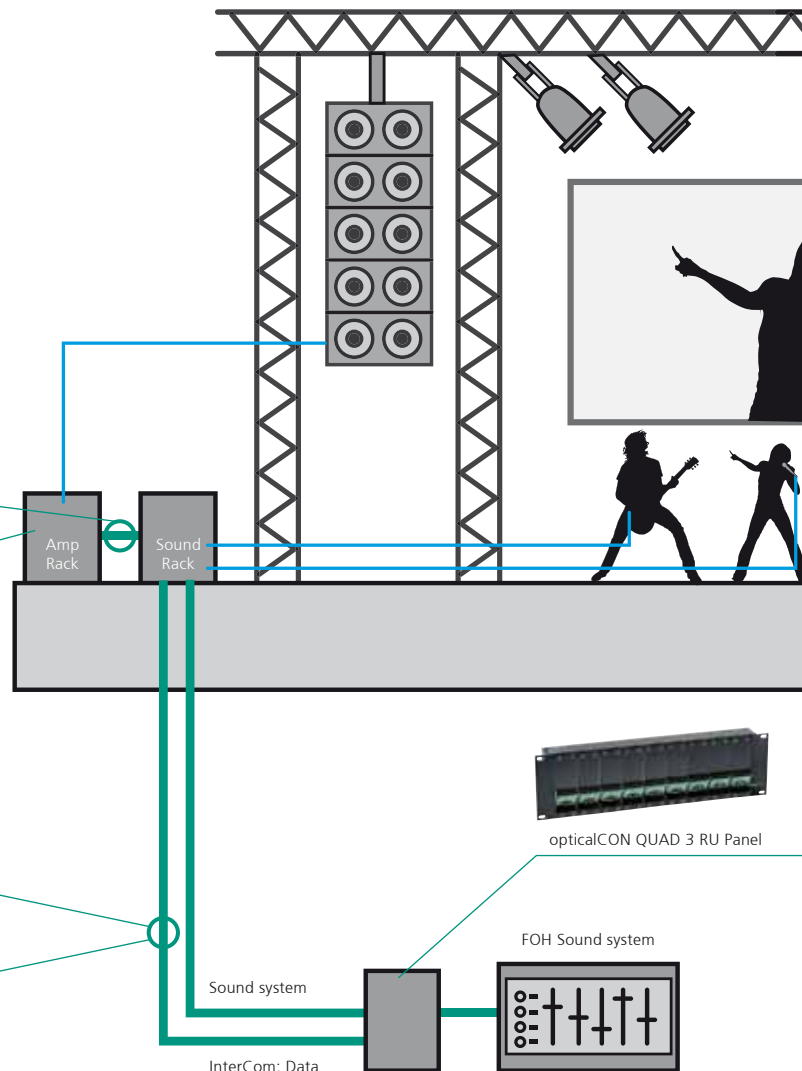
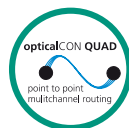

Video/Lighting

SOLOTECH, CANADA

Solotech uses the opticalCON connection system to transmit DVI video signals, ethernet control data (KVM), DMX networks as well as audio signals.

They work with the very latest lighting equipment and find as well innovative ways to use existing technology. The ideas of a creative team are turned into dazzling reality using articulated projectors, control boards, dimmers and an unparalleled array of cutting edge accessories. Color washes, re-imagined spaces, giant projections moving over any surface and 360° projections all spellbind audiences using the breathtaking world of visual effects.

30 years of providing lighting, video, sound and new media at both national and international levels makes Solotech known as an expert in video and lighting applications. Solotech has spent more than 10 years on tour with world stars like Celine Dion, André Rieu, the Cirque du Soleil and numerous other major artists.

»THIS SYSTEM IS FANTASTIC!
NEVER HAD A FAILURE YET.«

Cyril Bême, Operations Director, Solotech

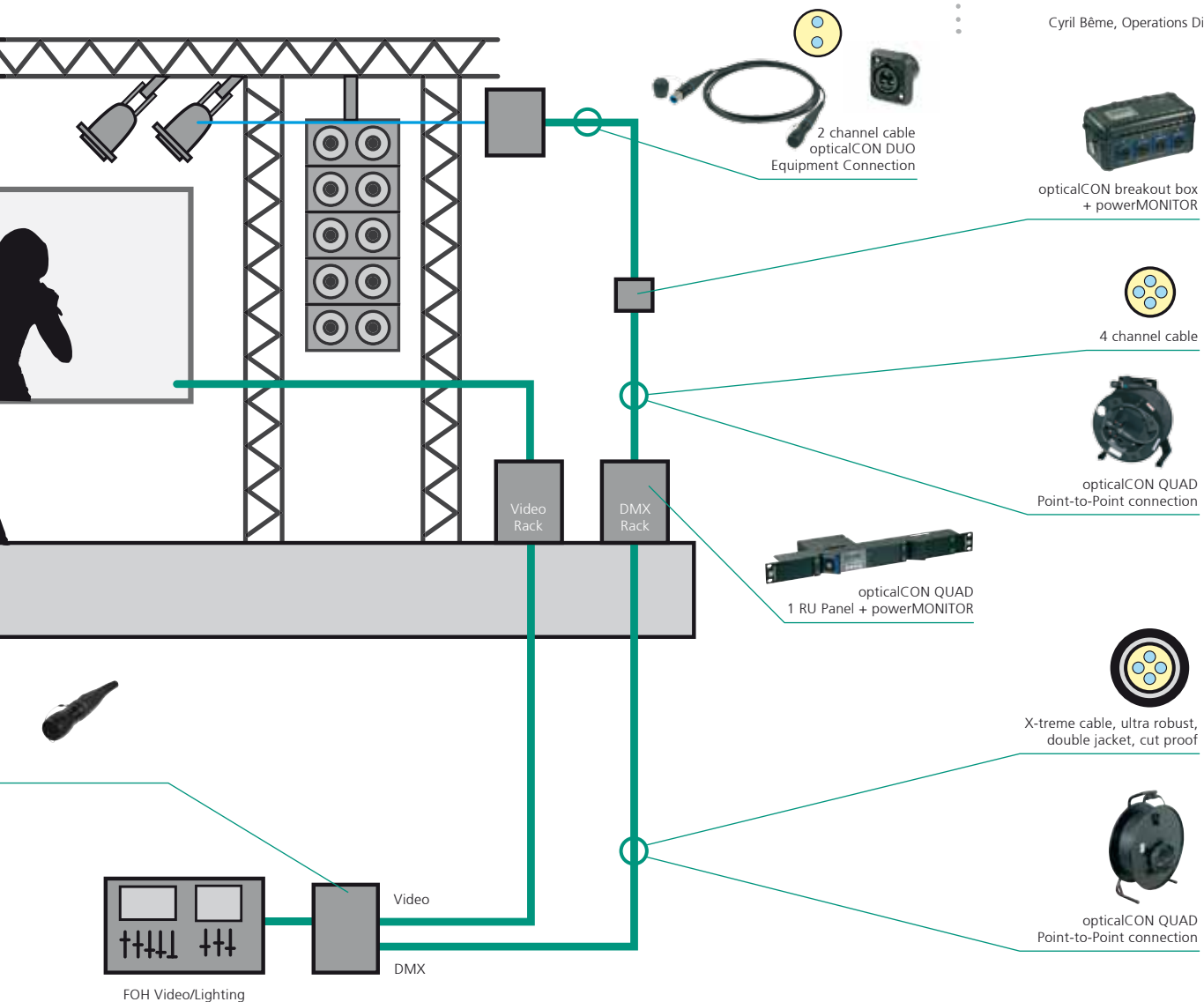

Applications

Broadcast - OB Truck

TPC, SWITZERLAND

The TPC (TV productioncenter zürich ag) has standardized the opticalCON QUAD for mobile outdoor fiber optic connectivity. The system has been applied for all fiber optic point-to-point routing applications, no matter what type of signal is required.

The provided fiber services include:

- Camera signals
- Video signal (monitors, displays, wall-displays)
- Audio networking
- Intercom
- Data (Ethernet, RS422, RS232)
- Broadcast signal distribution

With the standardization of the opticalCON the fiber optic point-to-point connectivity is nationwide compatible on I/O panels of OB-trucks, SNG-trucks, stadiums or national broadcast signal distribution boxes.

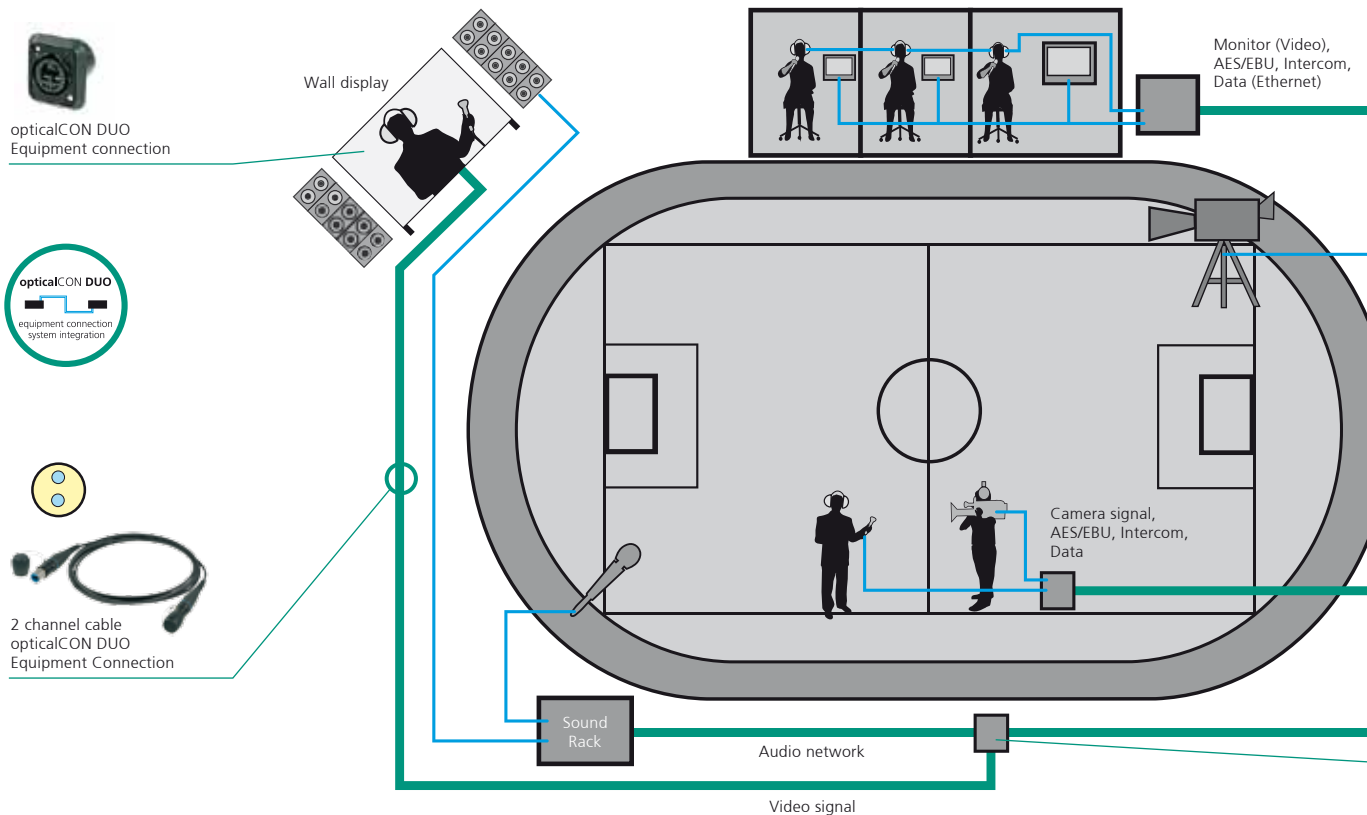
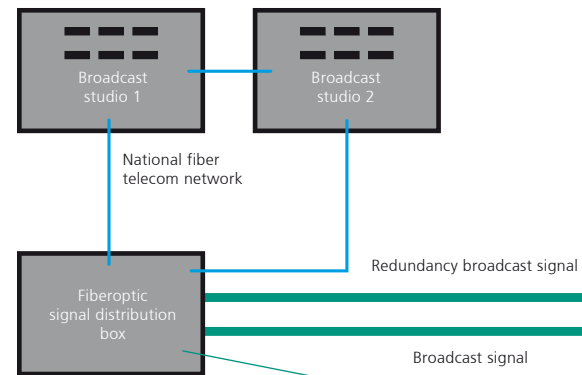

Depending to the size of the required installation, the setup team has the choice between 12 or 4 channel cables which are both based on the opticalCON QUAD connection system. The same cable can be used no matter if big stadium events, outdoor events (e.g. ski races) or SNG/ENG applications are required. Each channel can be in-dividually patched to the required equipment for the specific job.

»NEW EQUIPMENT AND NEW TECHNOLOGIES LIKE FOR EXAMPLE HDTV, ASK FOR INCREASING DATA TRANSMISSION RATES, WHICH CAN HARDLY BE REALIZED WITH COPPER CABLES ANY MORE. IN THIS REGARD FIBER OPTICS CAN BE CLASSIFIED AS THE PERFECT SUITABLE AND UP TO DATE TRANSMITTING MEDIUM FOR NEW TECHNOLOGIES. THE CONSEQUENT USE OF FIBER OPTICS REQUIRES A RELIABLE CONNECTOR ACCORDINGLY. TPC (TV PRODUCTION CENTER ZURICH AG) HAS CHOSEN THE OPTICALCON FIRST OF ALL BECAUSE OF ITS OPERATING RELIABILITY.«

Bruno Keller, project supervisor engineering

The TPC (TV productioncenter zürich ag) is part of SRG SSR idée suisse.

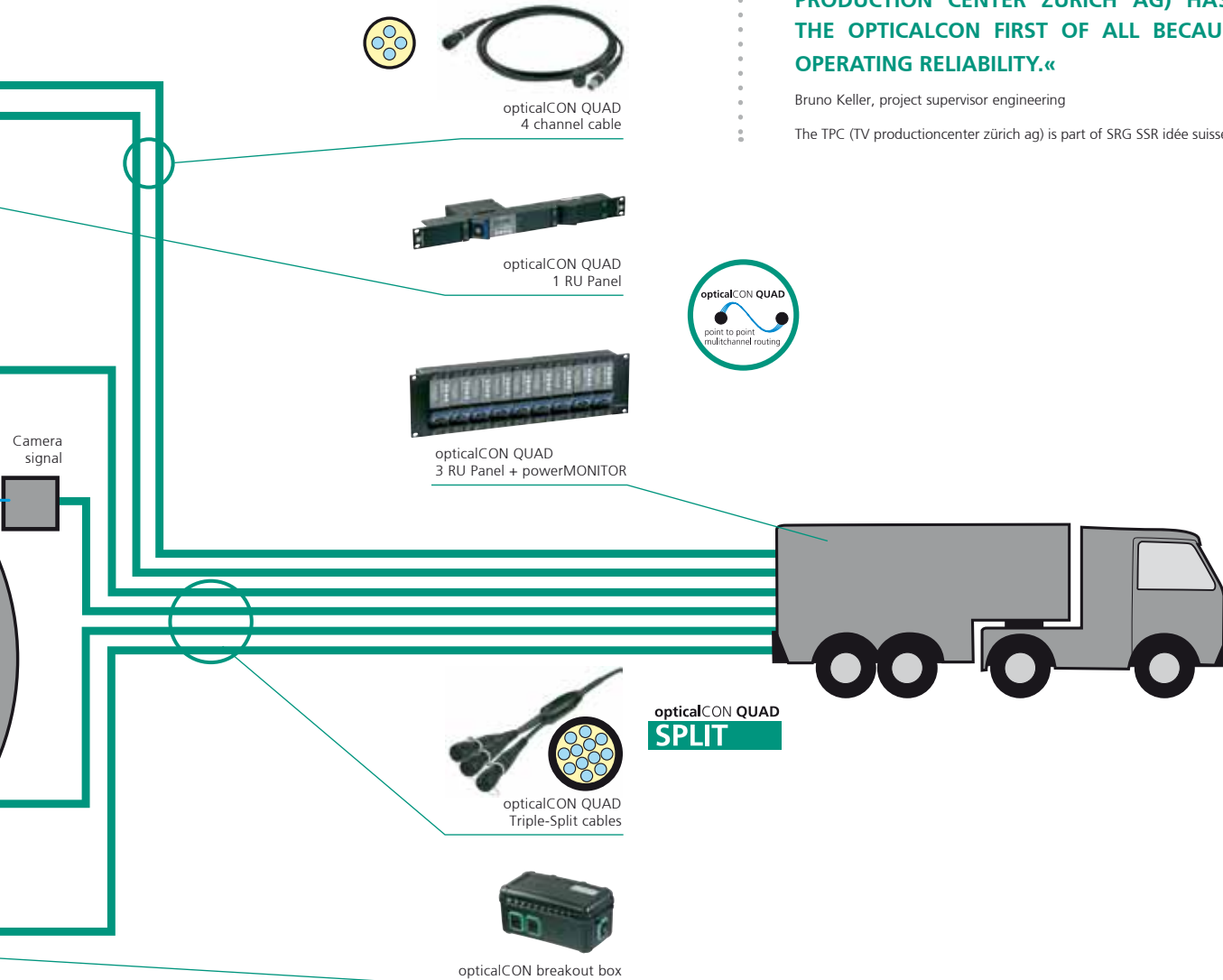

Applications

Broadcast - SNG/ENG

BORIS TV, UNITED KINGDOM

Boris TV uses Neutrik's opticalCON Low Voltage cable for series productions (e.g. at Twickenham Film Studios). The production requires frequent reconnection of links to cameras in a dusty environment, the shutters seal proved effective in preventing dust contamination of fibres.

The low voltage camera cable is a cost effective fiber optic hybrid cable solution and a great SMPTE cable alternative if only low voltage is required. The ultra flexible and lightweight (65 kg/km) design is optimized for camera link systems (e.g. for ENG / SNG¹), camera adapter systems, camera cranes and powered drop down converter boxes for broadcast applications where only ELV² (< 50Vac) is required.

»A PARTICULAR BENEFIT TO BORIS TELEVISION LTD HAS BEEN THE ABILITY TO CARRY ENOUGH CABLE TO SUPPORT 8 CAMERAS WITH A RANGE OF 150 M EACH WITHOUT REQUIRING ADDITIONAL LOGISTICAL SUPPORT TO CARRY CABLE TO THE LOCATION, THE LIGHT WEIGHT BEING A FURTHER BENEFIT IN THE HEALTH AND SAFETY ASPECT OF CABLE HANDLING WHEN COMPARED WITH OTHER TRIAX OR SMPTE FIBRE SYSTEMS. THIS FEATURE HAS ALLOWED BORIS TV TO REDUCE ITS SET UP AND BREAKDOWN CREW REQUIREMENT.«

CJ Smith, Managing Director, Van Diemen Films Ltd

Boris TV is a multicamera OB and equipment hire business which is part of Van Diemen Films.

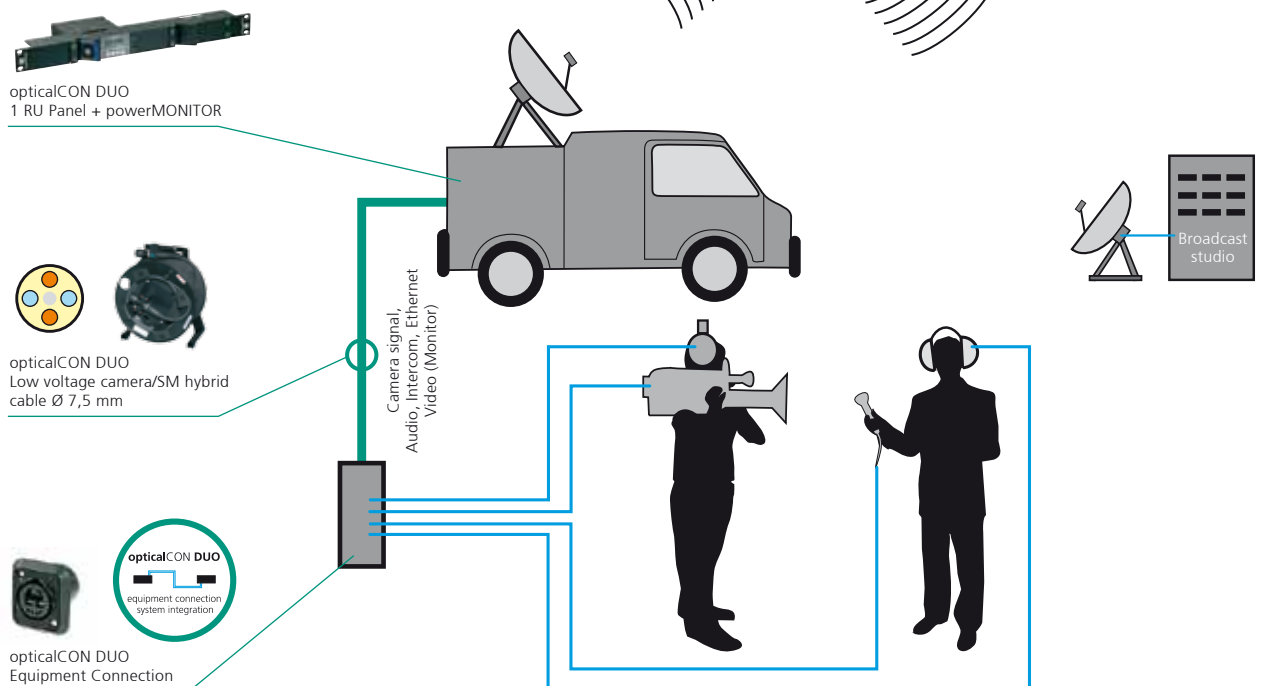
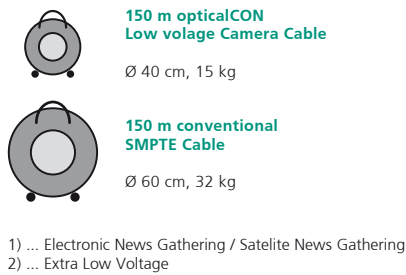

Broadcast - Studio Routing

opticalCON is the ideal solution for studio / OB-van patch rack applications. The system's sealing shutters ensure high mating cycles and minimized maintenance.

Typically used in high quantities, opticalCON chassis connectors are simple to install and very cost effective compared to other robust fiber optic connection systems. In particular, the opticalCON DUO chassis connector is well suited for system integrations, as it offers LC compatibility on both front and rear. With its four copper contacts, opticalCON DUO can be used both with cost-effective permanent LC patch cables and also for hybrid powered connections to broadcast cameras.

Boris TV uses the opticalCON DUO system with Low Voltage cables (e.g. at Desmet Studios in Amsterdam) for its frequent reconfigurations of camera and cable setups between studios. The system has proven to be effective and reliable.

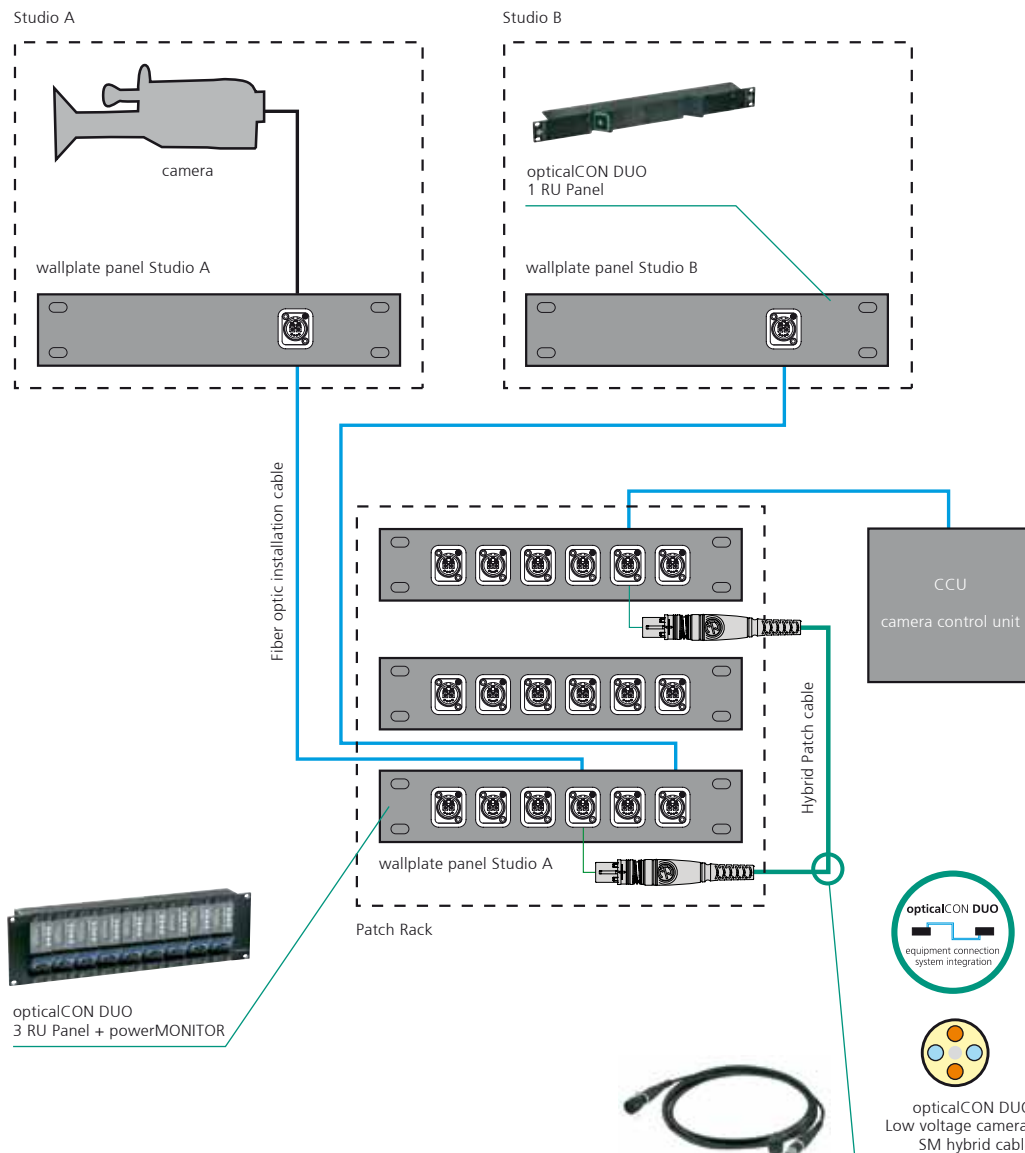

Wiring And Hook Up Suggestion

opticalCON DUO Or QUAD?

The opticalCON connection system offers high flexibility. The front and rear LC compatibility of the 2-channel opticalCON DUO makes the system ideal for equipment connections and system integration. The 4-channel opticalCON QUAD is focused on mobile, multichannel point-to-point connections.

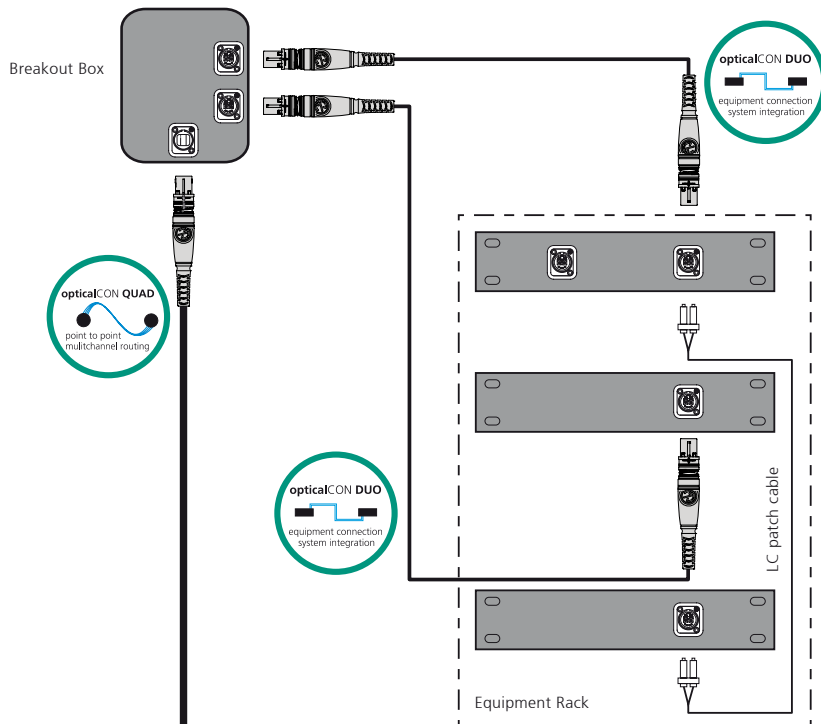

Cable Wiring

Fiber

In order to achieve uniform and compatible systems, Neutrik recommends following the wiring suggestions of the ISO / IEC 11801 which define channel A (right) as input and channel B (left) as output.

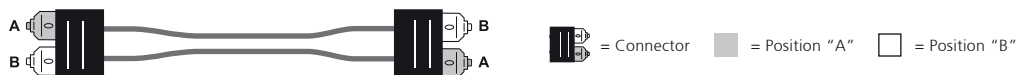

Copper

SMPT E WIRING

For studio camera wiring, Neutrik recommends following the SMPTE wiring suggestion:

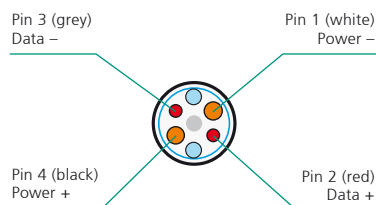

Low Voltage

For ELV (Extra Low Voltage) applications (< 50 V) Neutrik recommends the following wiring.

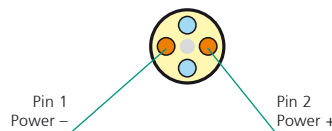

Liechtenstein (Headquarters)

NEUTRIK AG, Im alten Riet 143, 9494 Schaan
T +423 237 24 24, F +423 232 53 93, neutrik@neutrik.com

Germany/Netherlands/Denmark/Austria

Neutrik Vertriebs GmbH, Felix-Wankel-Strasse 1, 85221 Dachau
T +49 8131 28 08 90, info@neutrik.de

Great Britain

Neutrik (UK) Ltd., Westridge Business Park, Cothey Way
Ryde, Isle of Wight PO33 1 QT
T +44 1983 811 441, sales@neutrik.co.uk

France

Neutrik France SARL, Rue du Parchamp 13, 92100 Boulogne-Billancourt
T +33 1 41 31 67 50, info@neutrik.fr

USA

Neutrik USA Inc., 4115 Taggart Creek Road, Charlotte, North Carolina, 2820
T +1 704 972 30 50, info@neutrikusa.com

Japan

Neutrik Limited, Yusen-Higashinohbashi-Ekimae Bldg., 3-7-19
Higashinohbashi, Chuo-ku, Tokyo 103
T +81 3 3663 47 33, mail@neutrik.co.jp

Hong Kong

Neutrik Hong Kong LTD., Unit 18, 7 Floor Shatin Galleria
Nr. 18-24 Shan Mei Street, Foatan, Shatin
T +852 2687 6055, neutrik@neutrik.com.hk

China

Ningbo Neutrik Electronics Co., Ltd., Shiqi Street, Yinxian Road West
Fengjia Villiage, Yinzhou Area, Ningbo, Zhejiang; 315153
T +86 574 88250488 800, neutrik@neutrik.com.cn

www.neutrik.com

opticalCON

Данный компонент на территории Российской Федерации

Вы можете приобрести в компании MosChip.

Для оперативного оформления запроса Вам необходимо перейти по данной ссылке:

<http://moschip.ru/get-element>

Вы можете разместить у нас заказ для любого Вашего проекта, будь то серийное производство или разработка единичного прибора.

В нашем ассортименте представлены ведущие мировые производители активных и пассивных электронных компонентов.

Нашей специализацией является поставка электронной компонентной базы двойного назначения, продукции таких производителей как XILINX, Intel (ex.ALTERA), Vicor, Microchip, Texas Instruments, Analog Devices, Mini-Circuits, Amphenol, Glenair.

Сотрудничество с глобальными дистрибьюторами электронных компонентов, предоставляет возможность заказывать и получать с международных складов практически любой перечень компонентов в оптимальные для Вас сроки.

На всех этапах разработки и производства наши партнеры могут получить квалифицированную поддержку опытных инженеров.

Система менеджмента качества компании отвечает требованиям в соответствии с ГОСТ Р ИСО 9001, ГОСТ РВ 0015-002 и ЭС РД 009

Офис по работе с юридическими лицами:

105318, г.Москва, ул.Щербаковская д.3, офис 1107, 1118, ДЦ «Щербаковский»

Телефон: +7 495 668-12-70 (многоканальный)

Факс: +7 495 668-12-70 (доб.304)

E-mail: info@moschip.ru

Skype отдела продаж:

moschip.ru

moschip.ru_4

moschip.ru_6

moschip.ru_9