

DUAL, 250-mA OUTPUT, ULTRA-LOW NOISE, HIGH PSRR, LOW-DROPOUT LINEAR REGULATOR

 Check for Samples: [TPS71202-EP](#)

FEATURES

- Dual 250-mA High-Performance RF LDOs
- Adjustable Output Voltage (1.2 V to 5.5 V)
- High PSRR: 65 dB at 10 kHz
- Ultra-Low Noise: 32 μ Vrms
- Fast Start-Up Time: 60 μ s
- Stable with 2.2- μ F Ceramic Capacitor
- Excellent Load/Line Transient Response
- Very Low Dropout Voltage: 125 mV at 250 mA
- Independent Enable Pins
- Thermal Shutdown and Independent Current Limit
- Available in Thermally-Enhanced SON Package: 3 mm \times 3 mm \times 1 mm

APPLICATIONS

- Cellular and Cordless Phones
- Wireless PDA/Handheld Products
- PCMCIA/Wireless LAN Applications
- Digital Camera/Camcorder/Internet Audio
- DSP/FPGA/ASIC/Controllers and Processors

SUPPORTS DEFENSE, AEROSPACE, AND MEDICAL APPLICATIONS

- Controlled Baseline
- One Assembly/Test Site
- One Fabrication Site
- Available in Military ($-55^{\circ}\text{C}/125^{\circ}\text{C}$) Temperature Range⁽¹⁾
- Extended Product Life Cycle
- Extended Product-Change Notification
- Product Traceability

DESCRIPTION

The TPS71202 low-dropout (LDO) voltage regulator is tailored to noise-sensitive and RF applications. It features dual 250-mA LDOs with ultra-low noise, high power-supply rejection ratio (PSRR), and fast transient and start-up response. Each regulator output is stable with low-cost 2.2- μ F ceramic output capacitors and features very low dropout voltages (125 mV typical at 250 mA). The regulator achieves fast start-up times (approximately 60 μ s with a 0.001- μ F bypass capacitor) while consuming very low quiescent current (300 μ A typical with both outputs enabled). When the device is placed in standby mode, the supply current is reduced to less than 0.3 μ A typical. The regulator exhibits approximately 32 μ Vrms of output voltage noise with $V_{\text{OUT}} = 2.8$ V and a 0.01- μ F noise reduction (NR) capacitor. Applications with analog components that are noise-sensitive, such as portable RF electronics, benefit from high PSRR, low noise, and fast line and load transient features. The TPS71202 is offered in a thin 3-mm \times 3-mm SON package and is fully specified from -55°C to 125°C (T_{J}).

(1) Custom temperature ranges available



Please be aware that an important notice concerning availability, standard warranty, and use in critical applications of Texas Instruments semiconductor products and disclaimers thereto appears at the end of this data sheet.



This integrated circuit can be damaged by ESD. Texas Instruments recommends that all integrated circuits be handled with appropriate precautions. Failure to observe proper handling and installation procedures can cause damage.

ESD damage can range from subtle performance degradation to complete device failure. Precision integrated circuits may be more susceptible to damage because very small parametric changes could cause the device not to meet its published specifications.

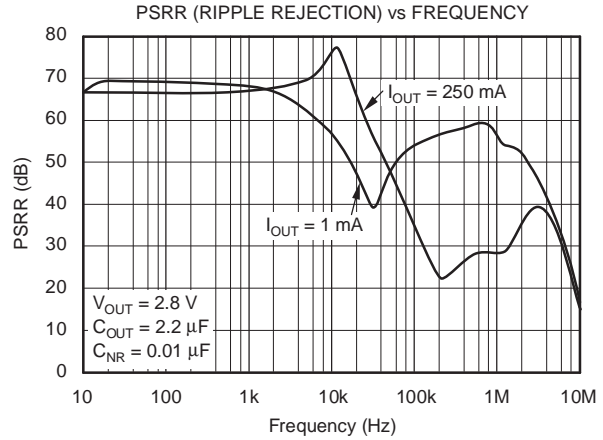
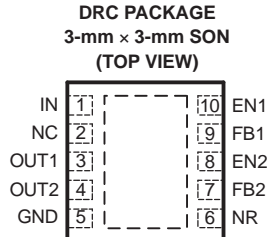

ORDERING INFORMATION⁽¹⁾

T _J	PACKAGE ⁽²⁾	ORDERABLE PART NUMBER	TOP-SIDE MARKING
-55°C to 125°C	SON-10 – DRC Reel of 250	TPS71202MDRCTEP	CVQ

- (1) For the most current package and ordering information, see the Package Option Addendum at the end of this document, or see the TI web site at www.ti.com.
- (2) Package drawings, thermal data, and symbolization are available at www.ti.com/packaging.

ABSOLUTE MAXIMUM RATINGS

over operating junction temperature range unless otherwise noted⁽¹⁾

V _{IN}	Input voltage range	IN	-0.3 V to 6 V
V _{EN1} , V _{EN2}	Input voltage range	EN1, EN2	-0.3 V to V _{IN} + 0.3 V
V _{OUT}	Output voltage range	OUT	-0.3 V to 6 V
	Peak output current		Internally limited
	Output short-circuit duration		Indefinite
	Continuous total power dissipation		See Thermal Information table
T _J	Junction temperature range		-55°C to 150°C
	Storage temperature range		-65°C to 150°C
ESD	Electrostatic discharge rating	Human-Body Model (HBM)	2000 V
		Charged-Device Model (CDM)	500 V

- (1) Stresses beyond those listed under *absolute maximum ratings* may cause permanent damage to the device. These are stress ratings only, and functional operation of the device at these or any other conditions beyond those indicated under the Electrical Characteristics is not implied. Exposure to absolute maximum rated conditions for extended periods may affect device reliability.

THERMAL INFORMATION

THERMAL METRIC ⁽¹⁾⁽²⁾		TPS71202-EP	UNITS
		DRC (10 PINS)	
θ_{JA}	Junction-to-ambient thermal resistance	49.6	°C/W
θ_{JCTop}	Junction-to-case (top) thermal resistance	70.0	
θ_{JB}	Junction-to-board thermal resistance	17.8	
ψ_{JT}	Junction-to-top characterization parameter	0.6	
ψ_{JB}	Junction-to-board characterization parameter	15.2	
θ_{JCbott}	Junction-to-case (bottom) thermal resistance	5.2	

(1) For more information about traditional and new thermal metrics, see the *IC Package Thermal Metrics* application report, [SPRA953](#).

(2) For thermal estimates of this device based on PCB copper area, see the [TI PCB Thermal Calculator](#).

ELECTRICAL CHARACTERISTICS

over operating temperature range ($T_J = -55^\circ\text{C}$ to $+125^\circ\text{C}$), V_{IN} = highest ($V_{OUT(nom)} + 1\text{ V}$) or 2.7 V (whichever is greater), $I_{OUT} = 1\text{ mA}$, $V_{EN1,2} = 1.2\text{ V}$, $C_{OUT} = 10\text{ }\mu\text{F}$, $C_{NR} = 0.01\text{ }\mu\text{F}$, and adjustable LDOs are tested at $V_{OUT} = 3.0\text{ V}$ (unless otherwise noted). Typical values are at $T_J = 25^\circ\text{C}$.

PARAMETER		TEST CONDITIONS	MIN	TYP	MAX	UNIT
V_{IN}	Input voltage range ⁽¹⁾		2.7		5.5	V
V_{FB}	Internal reference (adjustable LDOs)		1.200	1.225	1.250	V
V_{OUT}	Output voltage range (adjustable LDOs)		V_{FB}	$5.5 - V_{DO}$		V
	Accuracy ⁽¹⁾	Nominal	$T_J = +25^\circ\text{C}$, $I_{OUT} = 0\text{ mA}$	-1.5		+1.5
Over V_{IN} , I_{OUT} , and temperature		$V_{OUT} + 1.0\text{ V} \leq V_{IN} \leq 5.5\text{ V}$, $0\text{ }\mu\text{A} \leq I_{OUT} \leq 250\text{ mA}$	-3	1	+3	
$\Delta V_{OUT}\%/\Delta V_{IN}$	Line regulation ⁽¹⁾	$V_{OUT} + 1.0\text{ V} \leq V_{IN} \leq 5.5\text{ V}$		0.05		%/V
$\Delta V_{OUT}\%/\Delta I_{OUT}$	Load regulation	$0\text{ }\mu\text{A} \leq I_{OUT} \leq 250\text{ mA}$		0.8		%/mA
V_{DO}	Dropout voltage ($V_{IN} = V_{OUT(nom)} - 0.1\text{V}$)	$I_{OUT1} = I_{OUT2} = 250\text{ mA}$		125	315	mV
I_{CL}	Output current limit	$V_{OUT} = 0.9 \times V_{OUT(nom)}$	400	600	800	mA
I_{GND}	Ground pin current	One LDO enabled		190	250	μA
		Both LDOs enabled	$I_{OUT1} = I_{OUT2} = 1\text{ mA to }250\text{ mA}$	300	600	
I_{SHDN}	Shutdown current ⁽²⁾	$V_{EN} \leq 0.4\text{ V}$, $0\text{ V} \leq V_{IN} \leq 5.5\text{ V}$		0.3	2.0	μA
I_{FB}	FB pin current			0.1	1.50	μA
V_n	Output noise voltage, BW = 10 Hz to 100 kHz	No C_{NR} , $I_{OUT} = 250\text{ mA}$		$80.0 \times V_{OUT}$		μVrms
		$C_{NR} = 0.01\text{ }\mu\text{F}$, $I_{OUT} = 250\text{ mA}$		$11.8 \times V_{OUT}$		
PSRR	Power-supply rejection ratio (ripple rejection)	$f = 100\text{ Hz}$, $I_{OUT} = 250\text{ mA}$		65		dB
		$f = 10\text{ kHz}$, $I_{OUT} = 250\text{ mA}$		65		
t_{STR}	Startup time	$V_{OUT} = 2.85\text{ V}$, $R_L = 30\Omega$, $C_{NR} = 0.001\text{ }\mu\text{F}$		60		μs
V_{IH}	Enable threshold high (EN1, EN2)		1.2		V_{IN}	V
V_{IL}	Enable threshold low (EN1, EN2)		0		0.4	V
I_{EN}	Enable pin current (EN1, EN2)	$V_{IN} = V_{EN} = 5.5\text{ V}$	-1		1	μA
T_{SD}	Thermal shutdown temperature	Shutdown Temp increasing		+160		°C
		Reset Temp decreasing		+140		
UVLO	Undervoltage lockout threshold	V_{IN} rising	2.25		2.65	V
	Undervoltage lockout hysteresis	V_{IN} falling		100		mV

(1) Minimum $V_{IN} = (V_{OUT} + V_{DO})$ or 2.7 V, whichever is greater.

(2) For the adjustable version, this applies only after V_{IN} is applied; then V_{EN} transitions from high to low.

**FUNCTIONAL BLOCK DIAGRAM —
FIXED VERSION**

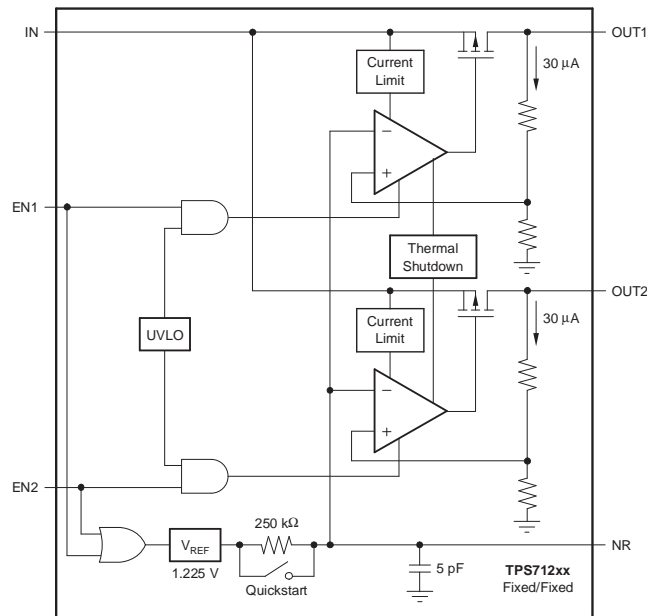

**FUNCTIONAL BLOCK DIAGRAM —
ADJUSTABLE VERSION**

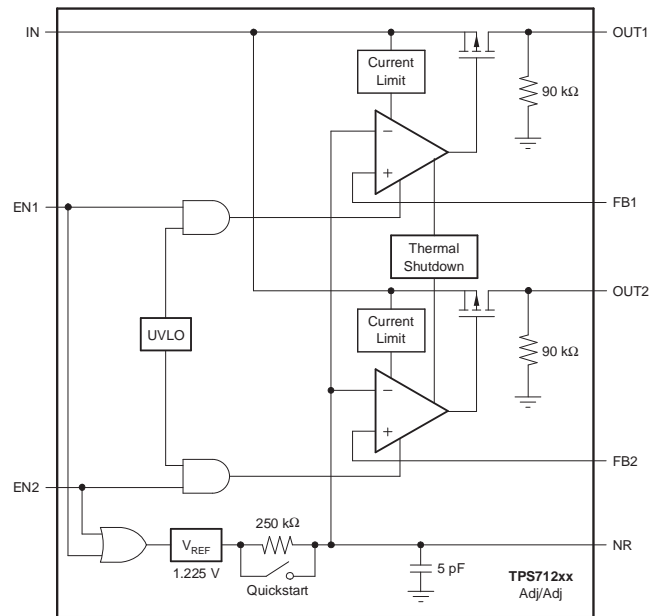

Table 1. TERMINAL FUNCTIONS

TERMINAL		DESCRIPTION
NAME	DRC	
IN	1	Unregulated input supply. A small 0.1- μ F capacitor should be connected from IN to GND.
GND	5, Pad	Ground
OUT1	3	Output of the regulator. A small 2.2- μ F ceramic capacitor is required from this pin to ground to assure stability.
OUT2	4	Same as OUT1 but for LDO2.
EN1	10	Driving the enable pin (EN) high turns on LDO1. Driving this pin low puts LDO1 into shutdown mode, reducing operating current. The enable pin should be connected to IN if not used.
EN2	8	Same as EN1 but controls LDO2.
FB1	9	Feedback for channel 1
FB2	7	Feedback for channel 2
NR	6	Noise reduction pin; connect an external bypass capacitor to reduce LDO output noise.
NC	2	No connection.

TYPICAL CHARACTERISTICS

For all voltage versions at $T_J = 25^\circ\text{C}$, $V_{IN} = V_{OUT(nom)} + 1\text{ V}$, $I_{OUT} = 1\text{ mA}$, $V_{EN} = 1.2\text{ V}$, $C_{OUT} = 2.2\ \mu\text{F}$, and $C_{NR} = 0.01\ \mu\text{F}$ (unless otherwise noted)

OUTPUT VOLTAGE vs INPUT VOLTAGE

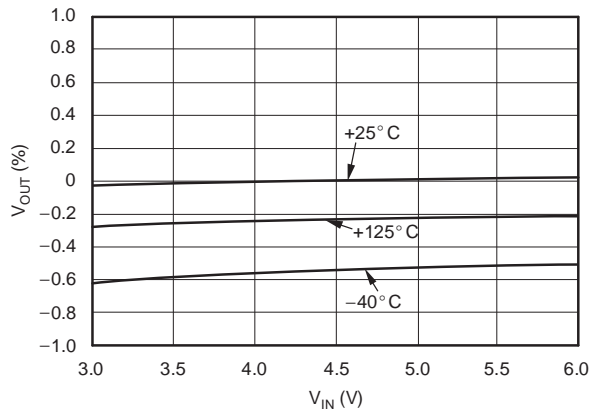

Figure 1.

OUTPUT VOLTAGE vs OUTPUT CURRENT

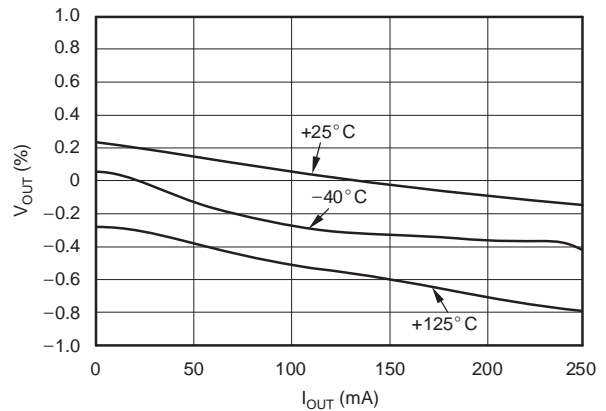

Figure 2.

OUTPUT VOLTAGE vs TEMPERATURE

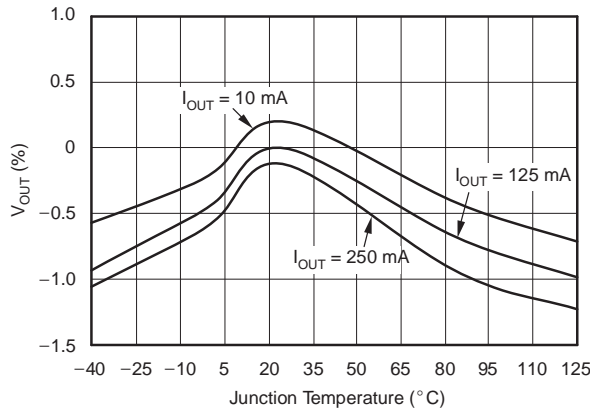

Figure 3.

DROPOUT VOLTAGE vs INPUT VOLTAGE (ADJUSTABLE VERSION)

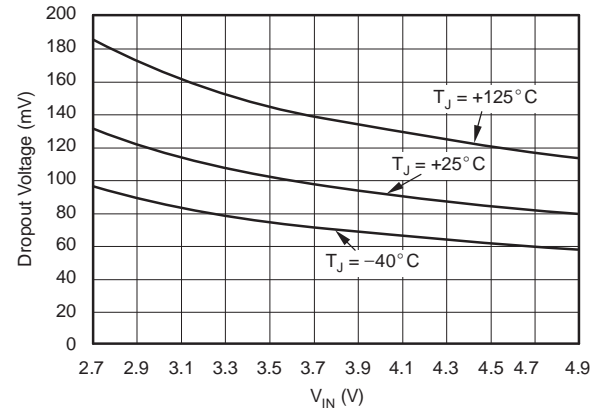

Figure 4.

TPS71256 DROPOUT VOLTAGE vs OUTPUT CURRENT

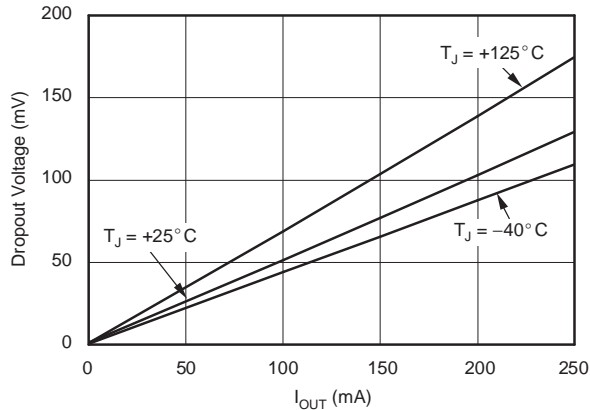

Figure 5.

TPS71256 DROPOUT VOLTAGE vs JUNCTION TEMPERATURE

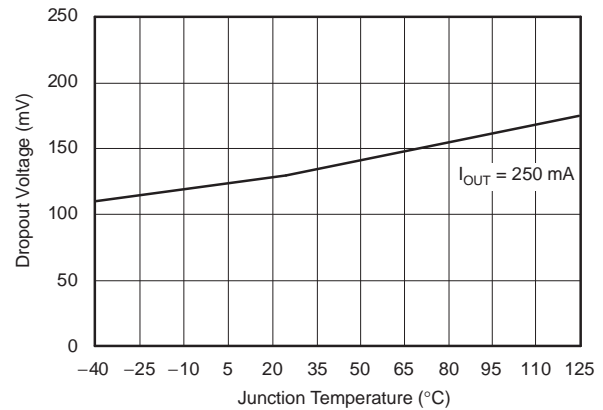

Figure 6.

TYPICAL CHARACTERISTICS (continued)

For all voltage versions at $T_J = 25^\circ\text{C}$, $V_{IN} = V_{OUT(nom)} + 1\text{ V}$, $I_{OUT} = 1\text{ mA}$, $V_{EN} = 1.2\text{ V}$, $C_{OUT} = 2.2\ \mu\text{F}$, and $C_{NR} = 0.01\ \mu\text{F}$ (unless otherwise noted)

GROUND PIN CURRENT vs INPUT VOLTAGE

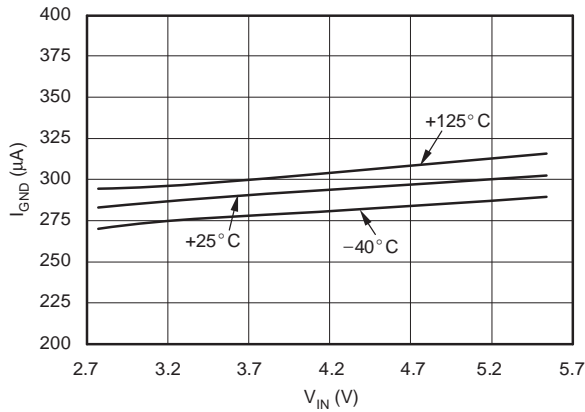

Figure 7.

GROUND PIN CURRENT vs I_OUT

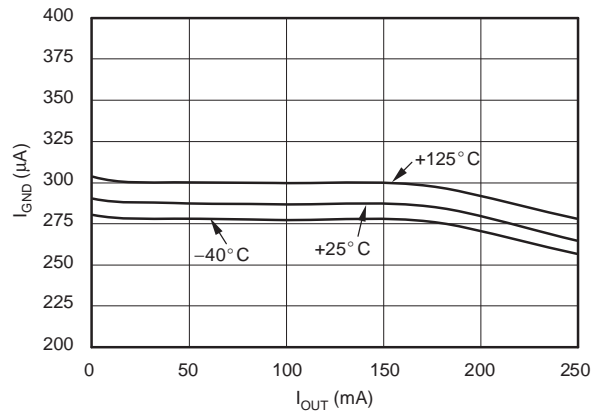

Figure 8.

GROUND PIN CURRENT vs JUNCTION TEMPERATURE

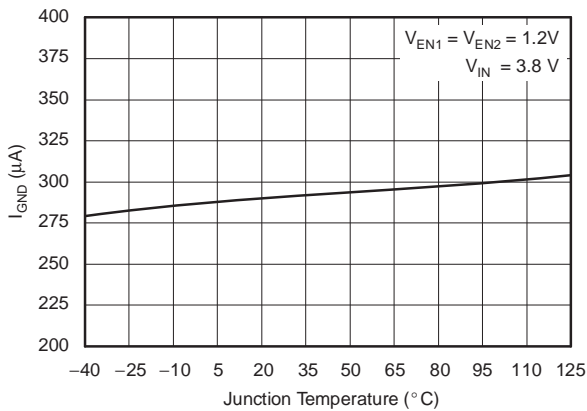

Figure 9.

GROUND PIN CURRENT vs JUNCTION TEMPERATURE (DISABLED)

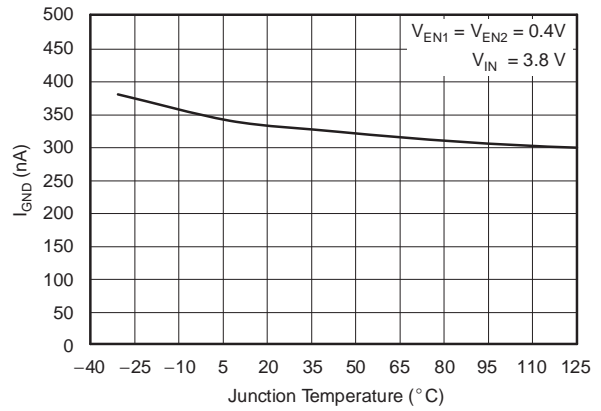

Figure 10.

CURRENT LIMIT vs JUNCTION TEMPERATURE

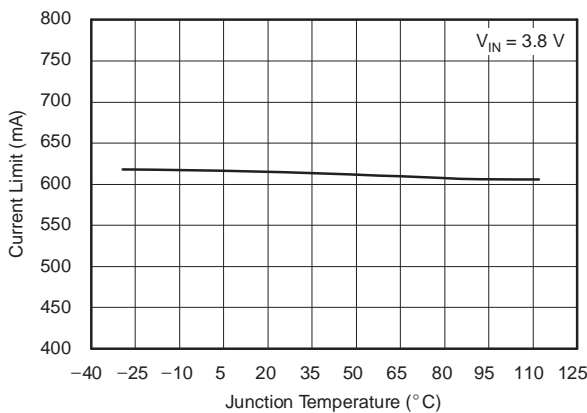

Figure 11.

**TPS71256
LINE TRANSIENT RESPONSE**

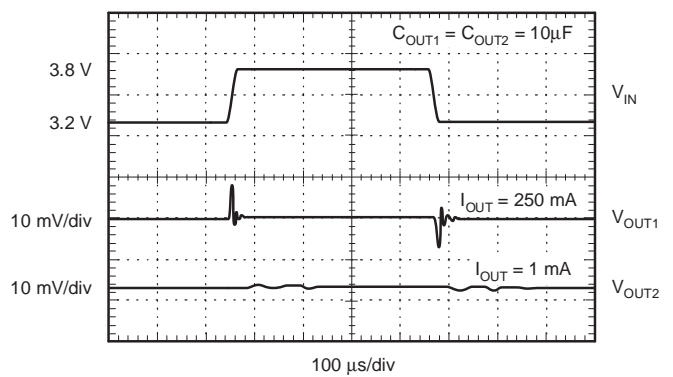

Figure 12.

TYPICAL CHARACTERISTICS (continued)

For all voltage versions at $T_J = 25^\circ\text{C}$, $V_{IN} = V_{OUT(nom)} + 1\text{ V}$, $I_{OUT} = 1\text{ mA}$, $V_{EN} = 1.2\text{ V}$, $C_{OUT} = 2.2\ \mu\text{F}$, and $C_{NR} = 0.01\ \mu\text{F}$ (unless otherwise noted)

**TPS71256
LOAD TRANSIENT RESPONSE
AND V_{OUT2} CROSSTALK**

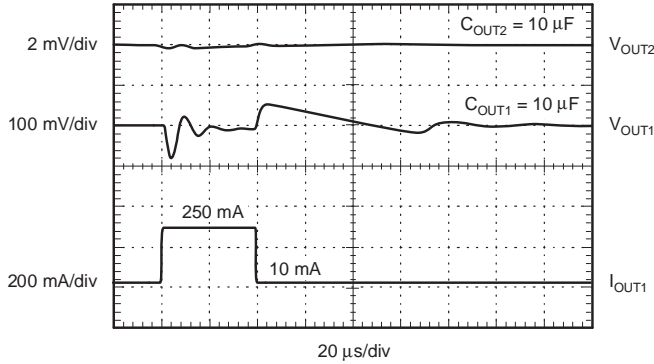

Figure 13.

**TPS71256
CHANNEL-TO-CHANNEL ISOLATION vs FREQUENCY**

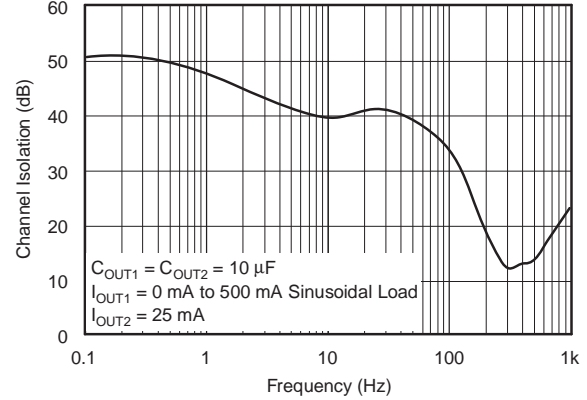

Figure 14.

**TPS71256
TURN-ON/TURN-OFF RESPONSE
AND V_{OUT2} CROSSTALK**

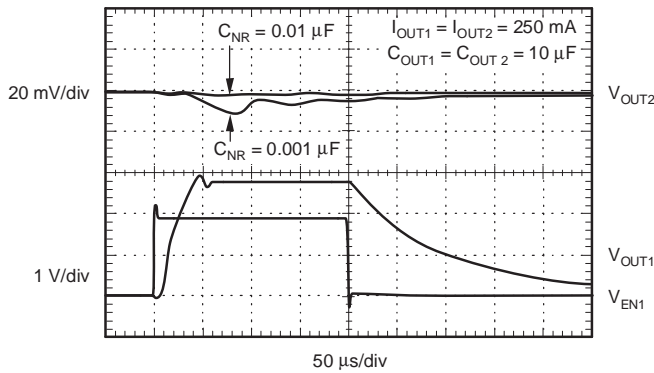

Figure 15.

**TPS71229
POWER-UP/POWER-DOWN**

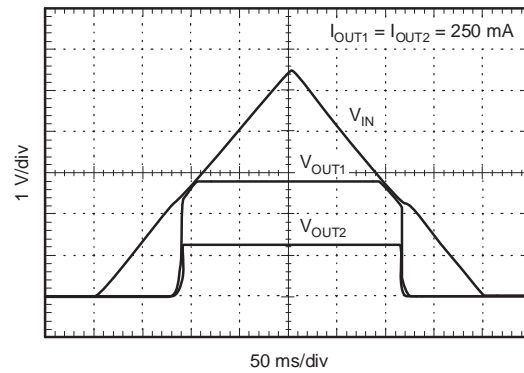

Figure 16.

TOTAL NOISE vs C_{NR}

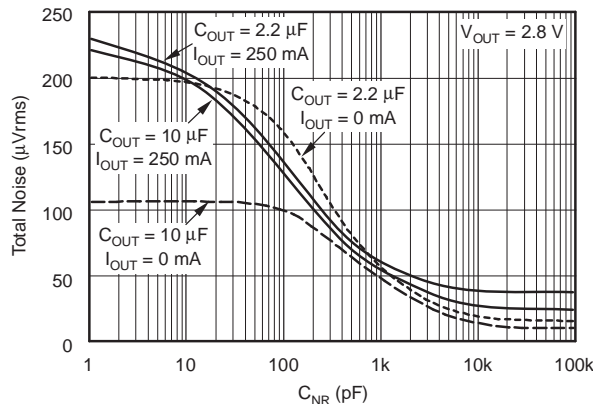

Figure 17.

**NOISE SPECTRAL DENSITY
 $C_{OUT} = 2.2\ \mu\text{F}$**

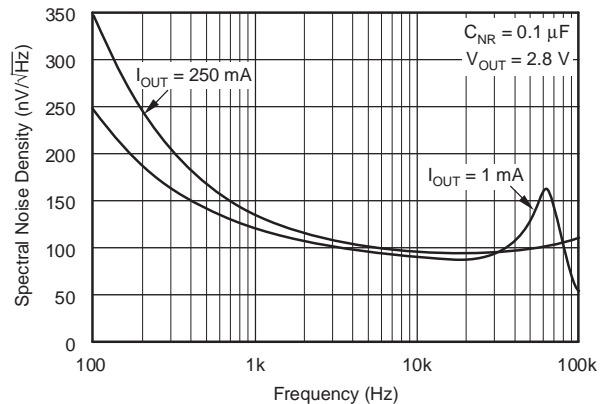

Figure 18.

TYPICAL CHARACTERISTICS (continued)

For all voltage versions at $T_J = 25^\circ\text{C}$, $V_{IN} = V_{OUT(nom)} + 1\text{ V}$, $I_{OUT} = 1\text{ mA}$, $V_{EN} = 1.2\text{ V}$, $C_{OUT} = 2.2\ \mu\text{F}$, and $C_{NR} = 0.01\ \mu\text{F}$ (unless otherwise noted)

NOISE SPECTRAL DENSITY
 $C_{OUT} = 10\ \mu\text{F}$

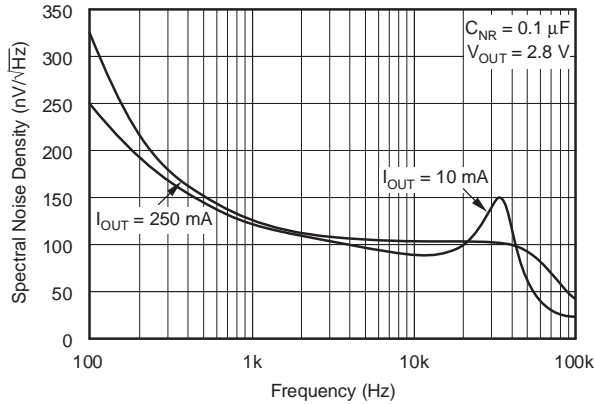

Figure 19.

NOISE SPECTRAL DENSITY vs C_NR

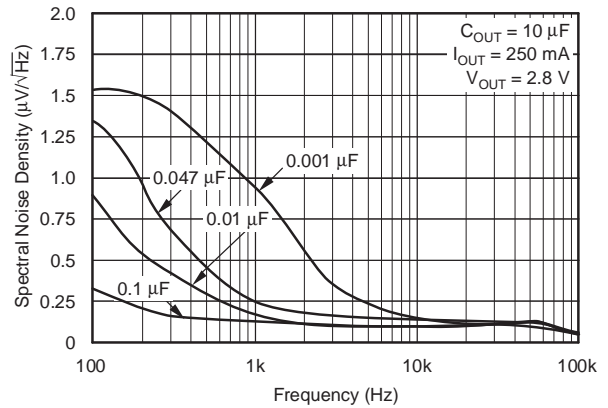

Figure 20.

PSRR (RIPPLE REJECTION) vs FREQUENCY

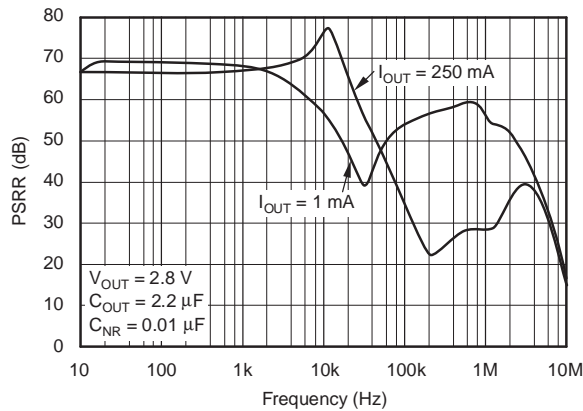

Figure 21.

PSRR (RIPPLE REJECTION) vs FREQUENCY

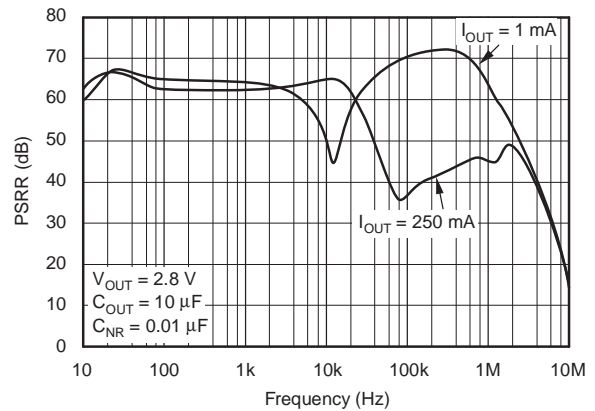

Figure 22.

PSRR (RIPPLE REJECTION) vs V_IN - V_OUT

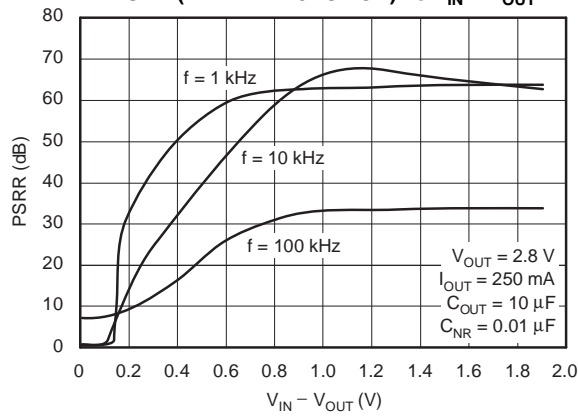

Figure 23.

APPLICATION INFORMATION

The TPS71202 dual low-dropout (LDO) regulator has been optimized for use in noise-sensitive battery-operated equipment. The device features extremely low dropout, high PSRR, ultra-low output noise, and low quiescent current (190 μ A typical per channel). When both outputs are disabled, the supply currents are reduced to less than 2 μ A.

INPUT AND OUTPUT CAPACITOR REQUIREMENTS

A 0.1- μ F or larger ceramic input bypass capacitor, connected between IN and GND and located close to the TPS71202, is required for stability. It improves transient response, noise rejection, and ripple rejection. A higher-value input capacitor may be necessary if large, fast rise-time load transients are anticipated and the device is located several inches from the power source.

The TPS71202 requires an output capacitor connected between the outputs and GND to stabilize the internal control loops. The minimum recommended output capacitor is 2.2 μ F. If an output voltage of 1.8 V or less is chosen, the minimum recommended output capacitor is 4.7 μ F. Any ceramic capacitor that meets the minimum output capacitor requirements is suitable. Capacitors with higher ESR may be used, provided the ESR is less than 1 Ω .

OUTPUT NOISE

The internal voltage reference is a key source of noise in an LDO regulator. The TPS71202 has an NR pin that is connected to the voltage reference through a 250-k Ω internal resistor. The 250-k Ω internal resistor, in conjunction with an external ceramic bypass capacitor connected to the NR pin, creates a low-pass filter to reduce the voltage reference noise and, therefore, the noise at the regulator output. To achieve a fast startup, the 250-k Ω internal resistor is shorted for 400 μ s after the device is enabled.

Because the primary noise source is the internal voltage reference, the output noise is greater for higher output voltage versions. For the case where no noise reduction capacitor is used, the typical noise (μ Vrms) over 10 Hz to 100 kHz is 80 times the output voltage. If a 0.01- μ F capacitor is used from the NR pin to ground, the noise (μ Vrms) drops to 11.8 times the output voltage.

STARTUP CHARACTERISTICS

To minimize startup overshoot, the TPS71202 initially targets an output voltage that is approximately 80% of the final value. To avoid a delayed startup time, noise reduction capacitors of 0.01 μ F or less are recommended. Larger noise reduction capacitors cause the output to hold at 80% until the voltage on the noise reduction capacitor exceeds 80% of the bandgap voltage. The typical startup time with a 0.001- μ F noise reduction capacitor is 60 μ s. Once one of the output voltages is present, the startup time of the other output is not affected by the noise reduction capacitor.

PROGRAMMING THE TPS71202 ADJUSTABLE LDO REGULATOR

The output voltage of the TPS71202 dual adjustable regulator is programmed using an external resistor divider, as shown in Figure 24. The output voltage is calculated using Equation 1:

$$V_{OUT} = V_{REF} \times \left(1 + \frac{R1}{R2}\right) \tag{1}$$

where $V_{REF} = 1.225\text{ V}$ (the internal reference voltage).

Resistors R2 and R4 should be chosen for approximately a 40- μA divider current. Lower value resistors can be used for improved noise performance but consume more power. Higher values should be avoided because leakage current at FB increases the output voltage error. The recommended design procedure is to choose $R2 = 30.1\text{ k}\Omega$ to set the divider current at 40 μA , and then calculate R1 using Equation 2:

$$R1 = \left(\frac{V_{OUT}}{V_{REF}} - 1\right) \times R2 \tag{2}$$

To improve the stability and noise performance of the adjustable version, a small compensation capacitor can be placed between OUT and FB.

For voltages $\leq 1.8\text{ V}$, the value of this capacitor should be 100 pF. For voltages $> 1.8\text{ V}$, the approximate value of this capacitor can be calculated as Equation 3:

$$C1 = \frac{(3 \times 10^5) \times (R1 + R2)}{(R1 \times R2)} \text{ (pF)} \tag{3}$$

The suggested value of this capacitor for several resistor ratios is shown in Figure 24. If this capacitor is not used (such as in a unity-gain configuration) or if an output voltage $\leq 1.8\text{ V}$ is chosen, then the minimum recommended output capacitor is 4.7 μF instead of 2.2 μF .

DROPOUT VOLTAGE

The TPS712xx uses a PMOS pass transistor to achieve extremely low dropout. When $(V_{IN} - V_{OUT})$ is less than the dropout voltage (V_{DO}), the PMOS pass device is in its linear region of operation and the input-to-output resistance is the $R_{DS, ON}$ of the PMOS pass element. Dropout voltages at lower currents can be approximated by calculating the effective $R_{DS, ON}$ of the pass element and multiplying that resistance by the load current. $R_{DS, ON}$ of the pass element can be obtained by dividing the dropout voltage by the rated output current.

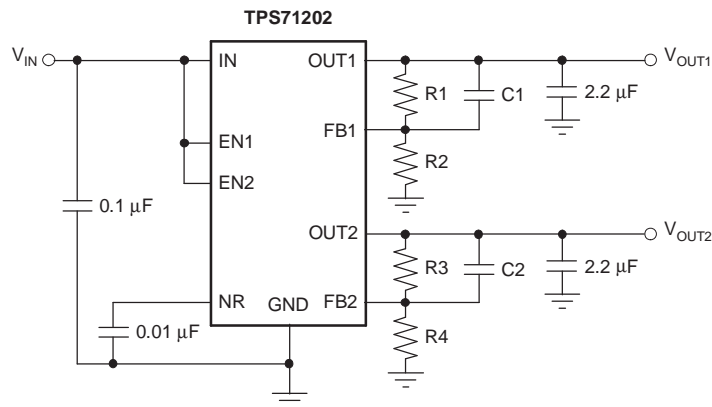

Output Voltage Programming Guide

V _{OUT}	R1/R3	R2/R4	C1/C2
1.225 V	Short	Open	Open
1.5 V	7.15 k Ω	30.1 k Ω	100 pF
2.5 V	31.6 k Ω	30.1 k Ω	22 pF
3.0 V	43.2 k Ω	30.1 k Ω	15 pF
3.3 V	49.9 k Ω	30.1 k Ω	15 pF
4.75 V	86.6 k Ω	30.1 k Ω	15 pF

Figure 24. Adjustable LDO Regulator Programming

TRANSIENT RESPONSE

As with any regulator, increasing the size of the output capacitor reduces overshoot/undershoot magnitude but increase duration of the transient response. In the adjustable version, the addition of a capacitor, C_{FB} , from the output to the feedback pin also improves stability and transient response. The transient response of the TPS71202 is enhanced with an active pulldown that engages when the output is overvoltage. The active pulldown decreases the output recovery time when the load is removed. [Figure 13](#) in the *Typical Characteristics* section shows the output transient response.

SHUTDOWN

Both enable pins are active high and are compatible with standard TTL-CMOS levels. The device is only completely disabled when both EN1 and EN2 are logic low. In this state, the LDO is completely off and the ground pin current drops to approximately 100 nA. With one output disabled, the ground pin current is slightly greater than half the nominal value. When shutdown capability is not required, the enable pins should be connected to the input supply.

INTERNAL CURRENT LIMIT

The TPS71202 internal current limit helps protect the regulator during fault conditions. During current limit, the output sources a fixed amount of current that is largely independent of the output voltage.

The TPS71202 PMOS-pass transistors have a built-in back diode that conducts reverse current when the input voltage drops below the output voltage (that is, during power-down). Current is conducted from the output to the input and is not internally limited. If extended reverse voltage operation is anticipated, external limiting may be appropriate.

THERMAL PROTECTION

Thermal protection disables both outputs when the junction temperature of either channel rises to approximately 160°C, allowing the device to cool. When the junction temperature cools to approximately 140°C, the output circuitry is again

enabled. Depending on power dissipation, thermal resistance, and ambient temperature, the thermal protection circuit may cycle on and off. This limits the dissipation of the regulator, protecting it from damage due to overheating.

Any tendency to activate the thermal protection circuit indicates excessive power dissipation or an inadequate heatsink. For reliable operation, junction temperature should be limited to 125°C maximum. To estimate the margin of safety in a complete design (including heatsink), increase the ambient temperature until the thermal protection is triggered; use worst-case loads and signal conditions. For good reliability, thermal protection should trigger at least 35°C above the maximum expected ambient condition of your application. This produces a worst-case junction temperature of 125°C at the highest expected ambient temperature and worst-case load.

The internal protection circuitry of the TPS71202 is designed to protect against overload conditions. It is not intended to replace proper heatsinking. Continuously running the TPS71202 into thermal shutdown degrades device reliability.

POWER DISSIPATION

The ability to remove heat from the die is different for each package type, presenting different considerations in the PCB layout. The PCB area around the device that is free of other components moves the heat from the device to the ambient air. Performance data for a JEDEC high-K board is shown in the *Dissipation Ratings* table. Using heavier copper increases the effectiveness in removing heat from the device. The addition of plated through-holes to heat-dissipating layers also improves the heat-sink effectiveness.

Power dissipation depends on input voltage and load conditions. Power dissipation (P_D) is equal to the product of the output current times the voltage drop across the output pass element (V_{IN} to V_{OUT}):

$$P_D = (V_{IN} - V_{OUT}) \times I_{OUT} \quad (4)$$

Power dissipation can be minimized by using the lowest possible input voltage necessary to ensure the required output voltage.

PACKAGING INFORMATION

Orderable Device	Status (1)	Package Type	Package Drawing	Pins	Package Qty	Eco Plan (2)	Lead/Ball Finish (6)	MSL Peak Temp (3)	Op Temp (°C)	Device Marking (4/5)	Samples
TPS71202MDRCTEP	ACTIVE	VSON	DRC	10	250	Green (RoHS & no Sb/Br)	CU NIPDAU	Level-2-260C-1 YEAR	-55 to 125	CVQ	Samples
V62/08621-01XE	ACTIVE	VSON	DRC	10	250	Green (RoHS & no Sb/Br)	CU NIPDAU	Level-2-260C-1 YEAR	-55 to 125	CVQ	Samples

(1) The marketing status values are defined as follows:

ACTIVE: Product device recommended for new designs.

LIFEBUY: TI has announced that the device will be discontinued, and a lifetime-buy period is in effect.

NRND: Not recommended for new designs. Device is in production to support existing customers, but TI does not recommend using this part in a new design.

PREVIEW: Device has been announced but is not in production. Samples may or may not be available.

OBSOLETE: TI has discontinued the production of the device.

(2) Eco Plan - The planned eco-friendly classification: Pb-Free (RoHS), Pb-Free (RoHS Exempt), or Green (RoHS & no Sb/Br) - please check <http://www.ti.com/productcontent> for the latest availability information and additional product content details.

TBD: The Pb-Free/Green conversion plan has not been defined.

Pb-Free (RoHS): TI's terms "Lead-Free" or "Pb-Free" mean semiconductor products that are compatible with the current RoHS requirements for all 6 substances, including the requirement that lead not exceed 0.1% by weight in homogeneous materials. Where designed to be soldered at high temperatures, TI Pb-Free products are suitable for use in specified lead-free processes.

Pb-Free (RoHS Exempt): This component has a RoHS exemption for either 1) lead-based flip-chip solder bumps used between the die and package, or 2) lead-based die adhesive used between the die and leadframe. The component is otherwise considered Pb-Free (RoHS compatible) as defined above.

Green (RoHS & no Sb/Br): TI defines "Green" to mean Pb-Free (RoHS compatible), and free of Bromine (Br) and Antimony (Sb) based flame retardants (Br or Sb do not exceed 0.1% by weight in homogeneous material)

(3) MSL, Peak Temp. - The Moisture Sensitivity Level rating according to the JEDEC industry standard classifications, and peak solder temperature.

(4) There may be additional marking, which relates to the logo, the lot trace code information, or the environmental category on the device.

(5) Multiple Device Markings will be inside parentheses. Only one Device Marking contained in parentheses and separated by a "~" will appear on a device. If a line is indented then it is a continuation of the previous line and the two combined represent the entire Device Marking for that device.

(6) Lead/Ball Finish - Orderable Devices may have multiple material finish options. Finish options are separated by a vertical ruled line. Lead/Ball Finish values may wrap to two lines if the finish value exceeds the maximum column width.

Important Information and Disclaimer: The information provided on this page represents TI's knowledge and belief as of the date that it is provided. TI bases its knowledge and belief on information provided by third parties, and makes no representation or warranty as to the accuracy of such information. Efforts are underway to better integrate information from third parties. TI has taken and continues to take reasonable steps to provide representative and accurate information but may not have conducted destructive testing or chemical analysis on incoming materials and chemicals. TI and TI suppliers consider certain information to be proprietary, and thus CAS numbers and other limited information may not be available for release.

In no event shall TI's liability arising out of such information exceed the total purchase price of the TI part(s) at issue in this document sold by TI to Customer on an annual basis.

OTHER QUALIFIED VERSIONS OF TPS71202-EP :

- Catalog: [TPS71202](#)

NOTE: Qualified Version Definitions:

- Catalog - TI's standard catalog product

TAPE AND REEL INFORMATION



QUADRANT ASSIGNMENTS FOR PIN 1 ORIENTATION IN TAPE



*All dimensions are nominal

Device	Package Type	Package Drawing	Pins	SPQ	Reel Diameter (mm)	Reel Width W1 (mm)	A0 (mm)	B0 (mm)	K0 (mm)	P1 (mm)	W (mm)	Pin1 Quadrant
TPS71202MDRCTEP	VSON	DRC	10	250	180.0	12.4	3.3	3.3	1.1	8.0	12.0	Q2

TAPE AND REEL BOX DIMENSIONS



*All dimensions are nominal

Device	Package Type	Package Drawing	Pins	SPQ	Length (mm)	Width (mm)	Height (mm)
TPS71202MDRCTEP	VSON	DRC	10	250	210.0	185.0	35.0

DRC (S-PVSON-N10)

PLASTIC SMALL OUTLINE NO-LEAD



- NOTES:
- All linear dimensions are in millimeters. Dimensioning and tolerancing per ASME Y14.5M-1994.
 - This drawing is subject to change without notice.
 - Small Outline No-Lead (SON) package configuration.
 - The package thermal pad must be soldered to the board for thermal and mechanical performance, if present.
 - See the additional figure in the Product Data Sheet for details regarding the exposed thermal pad features and dimensions, if present

THERMAL PAD MECHANICAL DATA

DRC (S-PVSON-N10)

PLASTIC SMALL OUTLINE NO-LEAD

THERMAL INFORMATION

This package incorporates an exposed thermal pad that is designed to be attached directly to an external heatsink. The thermal pad must be soldered directly to the printed circuit board (PCB). After soldering, the PCB can be used as a heatsink. In addition, through the use of thermal vias, the thermal pad can be attached directly to the appropriate copper plane shown in the electrical schematic for the device, or alternatively, can be attached to a special heatsink structure designed into the PCB. This design optimizes the heat transfer from the integrated circuit (IC).

For information on the Quad Flatpack No-Lead (QFN) package and its advantages, refer to Application Report, QFN/SON PCB Attachment, Texas Instruments Literature No. SLUA271. This document is available at www.ti.com.

The exposed thermal pad dimensions for this package are shown in the following illustration.

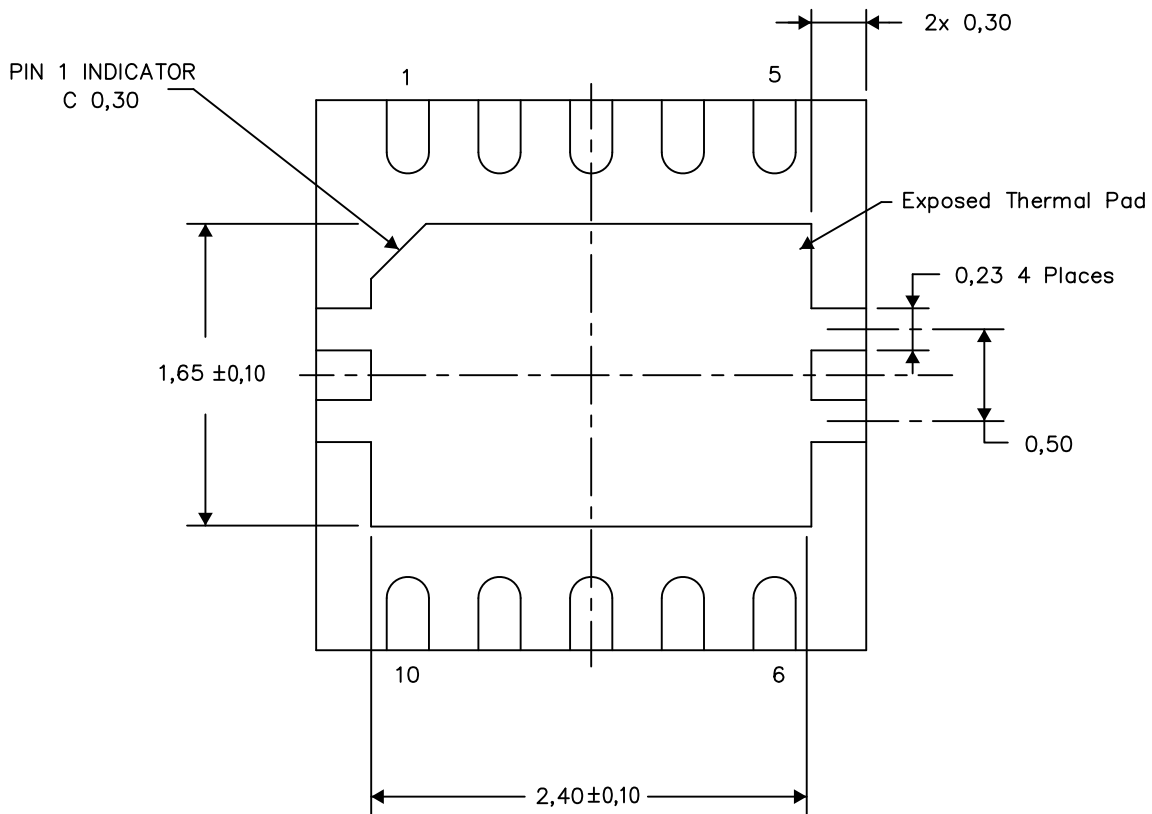

Bottom View

Exposed Thermal Pad Dimensions

4206565-3/U 04/14

NOTE: A. All linear dimensions are in millimeters

DRC (S-PVSON-N10)

PLASTIC SMALL OUTLINE NO-LEAD

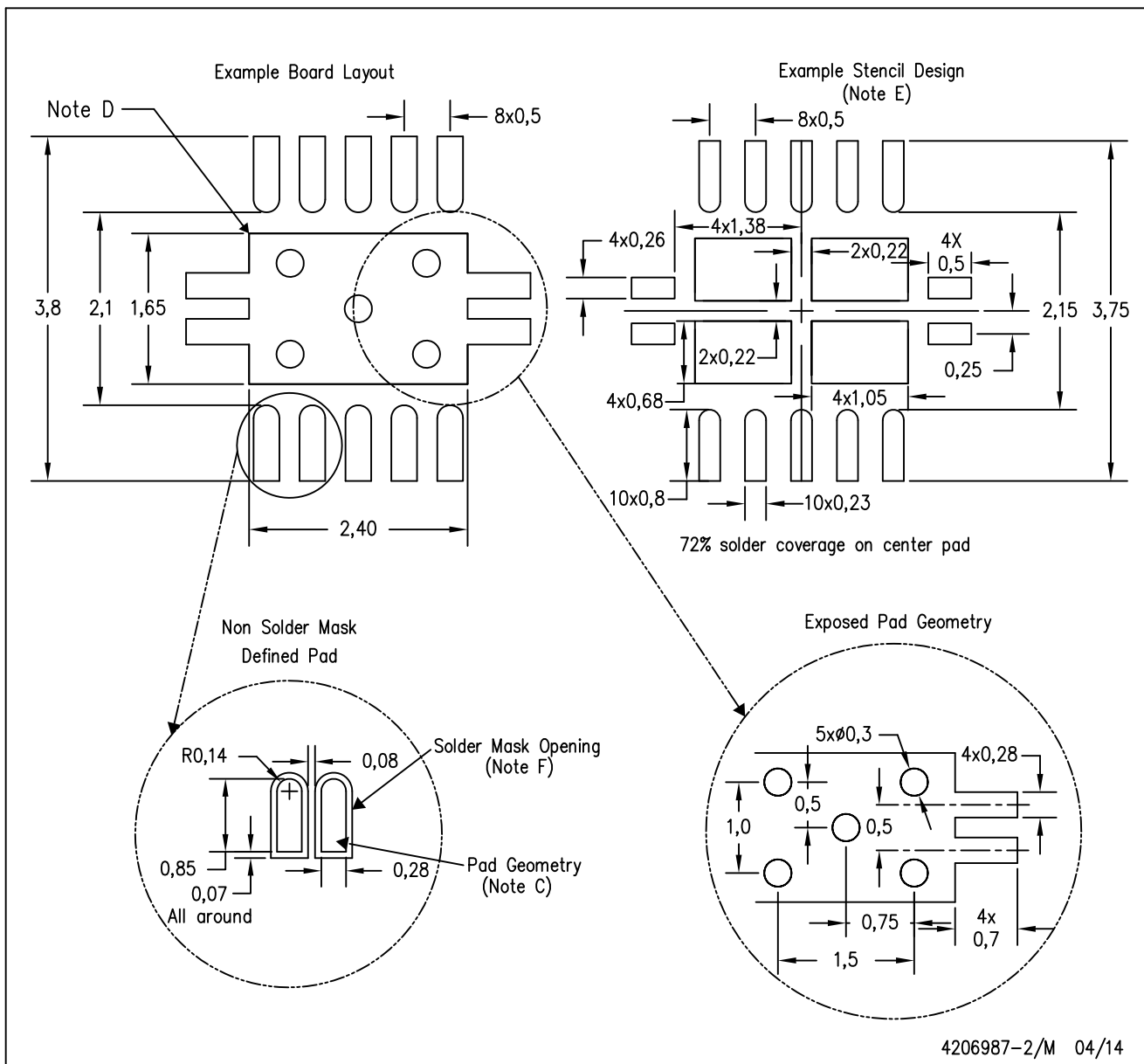

- NOTES:
- A. All linear dimensions are in millimeters.
 - B. This drawing is subject to change without notice.
 - C. Publication IPC-7351 is recommended for alternate designs.
 - D. This package is designed to be soldered to a thermal pad on the board. Refer to Application Note, Quad Flat-Pack Packages, Texas Instruments Literature No. SLUA271, and also the Product Data Sheets for specific thermal information, via requirements, and recommended board layout. These documents are available at www.ti.com <<http://www.ti.com>>.
 - E. Laser cutting apertures with trapezoidal walls and also rounding corners will offer better paste release. Customers should contact their board assembly site for stencil design recommendations. Refer to IPC 7525 for stencil design considerations.
 - F. Customers should contact their board fabrication site for minimum solder mask web tolerances between signal pads.

IMPORTANT NOTICE

Texas Instruments Incorporated and its subsidiaries (TI) reserve the right to make corrections, enhancements, improvements and other changes to its semiconductor products and services per JESD46, latest issue, and to discontinue any product or service per JESD48, latest issue. Buyers should obtain the latest relevant information before placing orders and should verify that such information is current and complete. All semiconductor products (also referred to herein as "components") are sold subject to TI's terms and conditions of sale supplied at the time of order acknowledgment.

TI warrants performance of its components to the specifications applicable at the time of sale, in accordance with the warranty in TI's terms and conditions of sale of semiconductor products. Testing and other quality control techniques are used to the extent TI deems necessary to support this warranty. Except where mandated by applicable law, testing of all parameters of each component is not necessarily performed.

TI assumes no liability for applications assistance or the design of Buyers' products. Buyers are responsible for their products and applications using TI components. To minimize the risks associated with Buyers' products and applications, Buyers should provide adequate design and operating safeguards.

TI does not warrant or represent that any license, either express or implied, is granted under any patent right, copyright, mask work right, or other intellectual property right relating to any combination, machine, or process in which TI components or services are used. Information published by TI regarding third-party products or services does not constitute a license to use such products or services or a warranty or endorsement thereof. Use of such information may require a license from a third party under the patents or other intellectual property of the third party, or a license from TI under the patents or other intellectual property of TI.

Reproduction of significant portions of TI information in TI data books or data sheets is permissible only if reproduction is without alteration and is accompanied by all associated warranties, conditions, limitations, and notices. TI is not responsible or liable for such altered documentation. Information of third parties may be subject to additional restrictions.

Resale of TI components or services with statements different from or beyond the parameters stated by TI for that component or service voids all express and any implied warranties for the associated TI component or service and is an unfair and deceptive business practice. TI is not responsible or liable for any such statements.

Buyer acknowledges and agrees that it is solely responsible for compliance with all legal, regulatory and safety-related requirements concerning its products, and any use of TI components in its applications, notwithstanding any applications-related information or support that may be provided by TI. Buyer represents and agrees that it has all the necessary expertise to create and implement safeguards which anticipate dangerous consequences of failures, monitor failures and their consequences, lessen the likelihood of failures that might cause harm and take appropriate remedial actions. Buyer will fully indemnify TI and its representatives against any damages arising out of the use of any TI components in safety-critical applications.

In some cases, TI components may be promoted specifically to facilitate safety-related applications. With such components, TI's goal is to help enable customers to design and create their own end-product solutions that meet applicable functional safety standards and requirements. Nonetheless, such components are subject to these terms.

No TI components are authorized for use in FDA Class III (or similar life-critical medical equipment) unless authorized officers of the parties have executed a special agreement specifically governing such use.

Only those TI components which TI has specifically designated as military grade or "enhanced plastic" are designed and intended for use in military/aerospace applications or environments. Buyer acknowledges and agrees that any military or aerospace use of TI components which have **not** been so designated is solely at the Buyer's risk, and that Buyer is solely responsible for compliance with all legal and regulatory requirements in connection with such use.

TI has specifically designated certain components as meeting ISO/TS16949 requirements, mainly for automotive use. In any case of use of non-designated products, TI will not be responsible for any failure to meet ISO/TS16949.

Products

Audio	www.ti.com/audio
Amplifiers	amplifier.ti.com
Data Converters	dataconverter.ti.com
DLP® Products	www.dlp.com
DSP	dsp.ti.com
Clocks and Timers	www.ti.com/clocks
Interface	interface.ti.com
Logic	logic.ti.com
Power Mgmt	power.ti.com
Microcontrollers	microcontroller.ti.com
RFID	www.ti-rfid.com
OMAP Applications Processors	www.ti.com/omap
Wireless Connectivity	www.ti.com/wirelessconnectivity

Applications

Automotive and Transportation	www.ti.com/automotive
Communications and Telecom	www.ti.com/communications
Computers and Peripherals	www.ti.com/computers
Consumer Electronics	www.ti.com/consumer-apps
Energy and Lighting	www.ti.com/energy
Industrial	www.ti.com/industrial
Medical	www.ti.com/medical
Security	www.ti.com/security
Space, Avionics and Defense	www.ti.com/space-avionics-defense
Video and Imaging	www.ti.com/video

TI E2E Community

e2e.ti.com

Данный компонент на территории Российской Федерации

Вы можете приобрести в компании MosChip.

Для оперативного оформления запроса Вам необходимо перейти по данной ссылке:

<http://moschip.ru/get-element>

Вы можете разместить у нас заказ для любого Вашего проекта, будь то серийное производство или разработка единичного прибора.

В нашем ассортименте представлены ведущие мировые производители активных и пассивных электронных компонентов.

Нашей специализацией является поставка электронной компонентной базы двойного назначения, продукции таких производителей как XILINX, Intel (ex.ALTERA), Vicor, Microchip, Texas Instruments, Analog Devices, Mini-Circuits, Amphenol, Glenair.

Сотрудничество с глобальными дистрибьюторами электронных компонентов, предоставляет возможность заказывать и получать с международных складов практически любой перечень компонентов в оптимальные для Вас сроки.

На всех этапах разработки и производства наши партнеры могут получить квалифицированную поддержку опытных инженеров.

Система менеджмента качества компании отвечает требованиям в соответствии с ГОСТ Р ИСО 9001, ГОСТ РВ 0015-002 и ЭС РД 009

Офис по работе с юридическими лицами:

105318, г.Москва, ул.Щербаковская д.3, офис 1107, 1118, ДЦ «Щербаковский»

Телефон: +7 495 668-12-70 (многоканальный)

Факс: +7 495 668-12-70 (доб.304)

E-mail: info@moschip.ru

Skype отдела продаж:

moschip.ru

moschip.ru_4

moschip.ru_6

moschip.ru_9