

Reflective Object Sensor

OPB711, OPB712



Features:

- Choice of phototransistor or photodarlington output
- Unfocused for sensing diffuse surface
- Low-cost plastic housing
- Choice of filter or unfiltered



Description:

OPB711 consists of an infrared emitting diode and an NPN silicon phototransistor, mounted “side-by-side” on parallel axes in a black opaque plastic housing. The **OPB712** consists of an infrared emitting diode and an NPN silicon photodarlington, mounted “side-by-side” on parallel axes in a black plastic housing.

OPB711's emitting diode and phototransistor are encapsulated in a filtering epoxy to reduce ambient light noise. Its phototransistor responds to radiation from the emitter only when a reflective object passes within its field of view.

OPB712's emitting diode and photodarlington are encapsulated in a filtering epoxy to reduce ambient light noise. Its photodarlington responds to radiation from the emitter only when a reflective object passes within its field of view.

Applications:

- Non-contact reflective object sensor
- Assembly line automation
- Machine automation
- Machine safety
- End of travel sensor
- Door sensor

Part Number	LED Peak Wavelength	Sensor	Reflection Distance Inch (mm)	Lead Length / Spacing
OPB711	890 nm	Transistor	0.080" (2.03mm)	0.30" / 0.095" & 0.100" "X" = 0.06" (1.5 mm)
OPB712		Darlington		

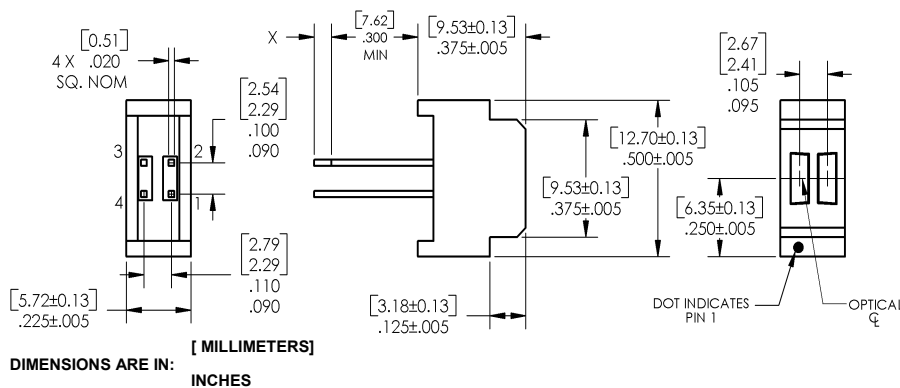

OPB711

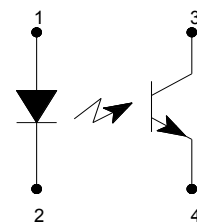

OPB712

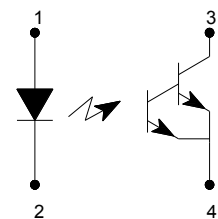

Pin #	LED	Pin #	Transistor
1	Anode	3	Collector
2	Cathode	4	Emitter



RoHS

General Note
TT Electronics reserves the right to make changes in product specification without notice or liability. All information is subject to TT Electronics' own data and is considered accurate at time of going to print.

OPTeK Technology, Inc.
1645 Wallace Drive, Carrollton, TX 75006 | Ph: +1 972 323 2200
www.optekinc.com | www.ttelectronics.com

Reflective Object Sensor

OPB711, OPB712



Absolute Maximum Ratings ($T_A = 25^\circ\text{C}$ unless otherwise noted)	
Storage & Operating Temperature Range	-40° C to +85° C
Lead Soldering Temperature [1/16 inch (1.6mm) from the case for 5 sec. with soldering iron] ⁽¹⁾	260° C
Input Diode (See OP268 for additional information—for reference only)	
Forward DC Current	50 mA
Peak Forward Current (1 μs pulse width, 300 pps)	3 A
Reverse DC Voltage	2 V
Power Dissipation ⁽²⁾	80 mW
Output Phototransistor (OPB711), Output Photodarlington (OPB712)	
Collector-Emitter Voltage OPB711 OPB712	24 V 15 V
Emitter-Collector Voltage	5 V
Collector DC Current OPB711 OPB712	25 mA 125 mA
Power Dissipation OPB711 ⁽²⁾ OPB712 ⁽³⁾	80 mW 125 mW

Notes:

- (1) RMA flux is recommended. Duration can be extended to 10 seconds maximum when flow soldering.
- (2) Derate linearly 1.33 mW/cm² above 25 ° C.
- (3) Derate linearly 2.08 mW/° C above 25° C.

Reflective Object Sensor

OPB711, OPB712



Electrical Characteristics (T _A = 25° C unless otherwise noted)						
SYMBOL	PARAMETER	MIN	TYP	MAX	UNITS	TEST CONDITIONS
Input Diode (see OP168F for additional information)						
V _F	Forward Voltage	-	-	1.7	V	I _F = 20 mA
I _R	Reverse Current	-	-	100	μA	V _R = 2 V
Output Phototransistor (OPB711—See OP508F for additional information)						
Output Photodarlington (OPB712—See OP538F for additional information)						
V _{(BR)CEO}	Collector-Emitter Breakdown Voltage					
	OPB711	24	-	-	V	I _C = 100 μA
	OPB712	15	-	-		
V _{(BR)ECO}	Emitter-Collector Breakdown Voltage	5	-	-	V	I _E = 100 μA
I _{CEO}	Collector Dark Current					
	OPB711	-	-	100	nA	V _{CE} = 10 V, I _F = 0, E _E = ≤ 0.1 μW/cm ²
	OPB712	-	-	250		
Combined						
V _{CE(SAT)}	Collector-Emitter Saturation Voltage ⁽¹⁾⁽²⁾					
	OPB711	-	-	.4	V	I _F = 20 mA, I _C = 50 μA, d = 0.080" (2.03 mm)
	OPB712	-	-	1.1		
I _{C(ON)}	On-State Collector Current ⁽¹⁾⁽²⁾					
	OPB711	.35	-	4.5	mA	I _F = 20 mA, V _{CE} = 5 V, d = 0.080" (2.03 mm)
	OPB712	20	-	50	mA	
I _{CX}	Crosstalk					
	OPB711 ⁽³⁾	-	-	100	nA	V _{CE} = 5 V, I _F = 20 mA (no reflecting surface)
	OPB712 ⁽⁴⁾	-	-	25	μA	

Notes:

- (1) On OPB711, D is the distance from the assembly measurement surface to the reflective surface. On OPB712, D is the distance from the assembly face to the reflective surface.
- (2) Measured using Eastman Kodak neutral white test card with 90% diffuse reflectance as a reflecting surface. Reference: Eastman Kodak, Catalog #E 152 7795.
- (3) Crosstalk (I_{CX}) is the collector current measured with the indicated current in the input diode and with no reflective surface.
- (4) All parameters were tested using pulse techniques.

Reflective Object Sensor

OPB711, OPB712



OPB711 - Output vs Distance

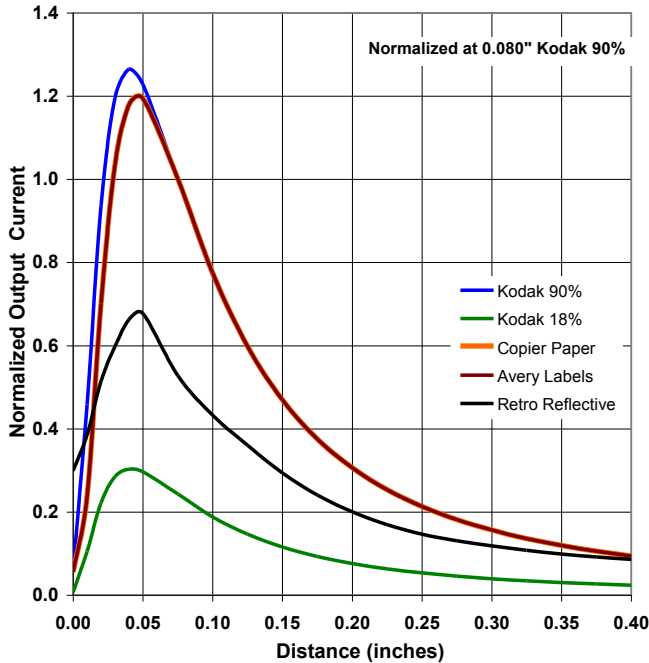

OPB712 - Output vs Distance

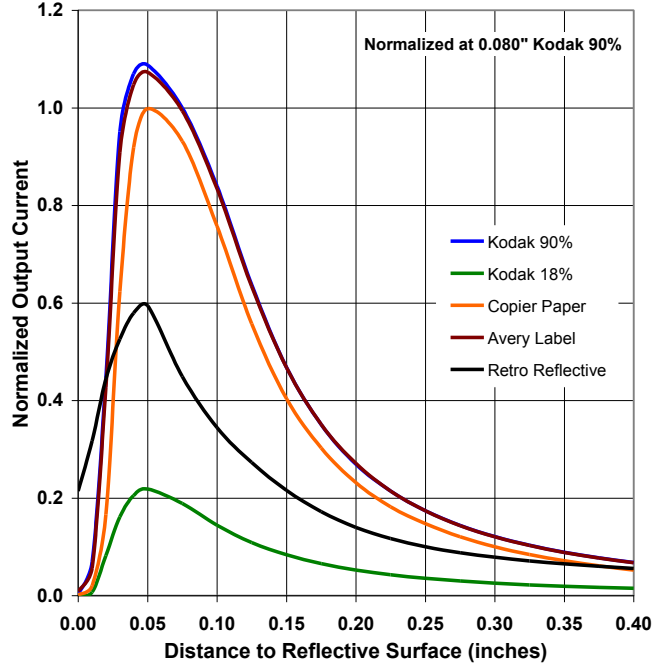

OPB711 - Normalized Collector Current vs Forward Current vs Temperature

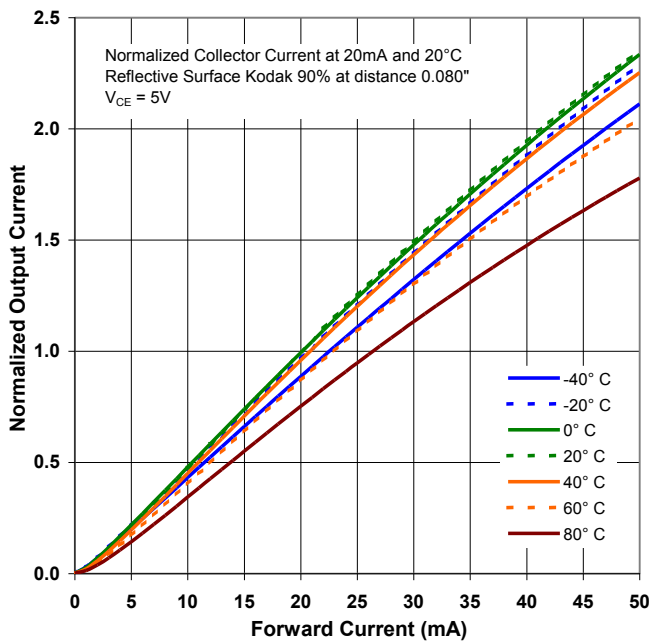

OPB712 - Normalized Collector Current vs Forward Current vs Temperature

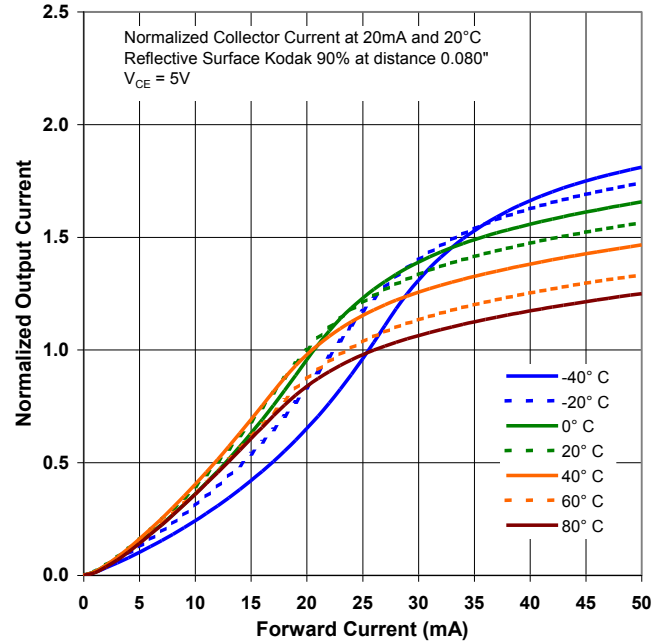

General Note
TT Electronics reserves the right to make changes in product specification without notice or liability. All information is subject to TT Electronics' own data and is considered accurate at time of going to print.

OPTEK Technology, Inc.
1645 Wallace Drive, Carrollton, TX 75006 | Ph: +1 972 323 2200
www.optekinc.com | www.ttelectronics.com

Данный компонент на территории Российской Федерации

Вы можете приобрести в компании MosChip.

Для оперативного оформления запроса Вам необходимо перейти по данной ссылке:

<http://moschip.ru/get-element>

Вы можете разместить у нас заказ для любого Вашего проекта, будь то серийное производство или разработка единичного прибора.

В нашем ассортименте представлены ведущие мировые производители активных и пассивных электронных компонентов.

Нашей специализацией является поставка электронной компонентной базы двойного назначения, продукции таких производителей как XILINX, Intel (ex.ALTERA), Vicor, Microchip, Texas Instruments, Analog Devices, Mini-Circuits, Amphenol, Glenair.

Сотрудничество с глобальными дистрибьюторами электронных компонентов, предоставляет возможность заказывать и получать с международных складов практически любой перечень компонентов в оптимальные для Вас сроки.

На всех этапах разработки и производства наши партнеры могут получить квалифицированную поддержку опытных инженеров.

Система менеджмента качества компании отвечает требованиям в соответствии с ГОСТ Р ИСО 9001, ГОСТ РВ 0015-002 и ЭС РД 009

Офис по работе с юридическими лицами:

105318, г.Москва, ул.Щербаковская д.3, офис 1107, 1118, ДЦ «Щербаковский»

Телефон: +7 495 668-12-70 (многоканальный)

Факс: +7 495 668-12-70 (доб.304)

E-mail: info@moschip.ru

Skype отдела продаж:

moschip.ru

moschip.ru_4

moschip.ru_6

moschip.ru_9