

Features

- Attenuation: 1 dB Steps to 50 dB
- Single Positive Supply
- Contains Internal DC to DC Converter
- Low DC Power Consumption
- Small Footprint, JEDEC Package
- Integral TTL Driver
- 50 ohm Impedance
- Lead-Free CSP-1 Package
- 100% Matte Tin Plating over Copper
- Halogen-Free "Green" Mold Compound
- 260°C Reflow Compatible
- RoHS* Compliant Version of AT90-1106

Description

M/A-COM's MAAD-007080-000100 is a GaAs FET 6-bit digital attenuator with integral TTL driver. Step size is 1 dB providing a 50 dB total attenuation range. This device is in a PQFN plastic surface mount package. MAAD-007080-000100 is ideally suited for use where accuracy, fast speed, very low power consumption and low costs are required. For dual supply designs without switching noise, use MAAD-007082-000100.

Ordering Information

Part Number	Package
MAAD-007080-00100	Bulk Packaging
MAAD-007080-001TR	1000 piece reel
MAAD-0007080-001TB	Sample Test Board

Note: Reference Application Note M513 for reel size information.

* Restrictions on Hazardous Substances, European Union Directive 2002/95/EC.

Functional Schematic

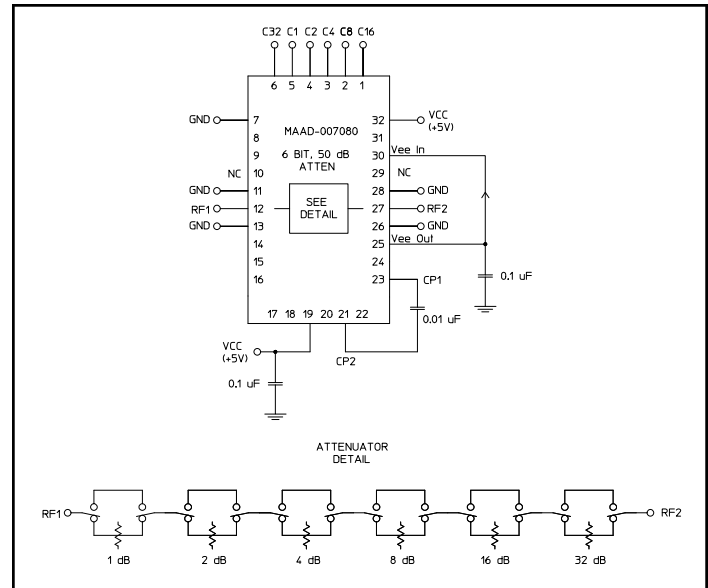

Pin Configuration¹

Pin No.	Function	Pin No.	Function
1	C16	17	NC
2	C8	18	NC
3	C4	19	+Vcc
4	C2	20	NC
5	C1	21	Cp
6	C32	22	NC
7	GND	23	Cp
8	NC	24	NC
9	NC	25	-Vee ³
10	NC ²	26	GND
11	GND	27	RF2
12	RF1	28	GND
13	GND	29	NC ²
14	NC	30	-Vee ³
15	NC	31	NC
16	NC	32	+Vcc

1. The exposed pad centered on the package bottom must be connected to RF and DC ground. (For PQFN Packages)
2. Pins 10 & 29 must be isolated
3. -Vee is produced internally and requires a .1µF cap to GND. Generated noise is typical of switching DC-DC Converters.

Digital Attenuator 50.0 dB, 6-Bit, TTL Driver, DC-2.4 GHz

Rev. V4

Electrical Specifications: $T_A = 25^\circ\text{C}$, $Z_0 = 50\Omega$

Parameter	Test Conditions	Frequency	Units	Min	Typ	Max
Insertion Loss	—	DC - 2.4 GHz	dB	—	5.5	6.0
Attenuation Accuracy	Individual Bits 1-2-4-8-16-32 dB Any Combination of Bits 1 to 50 dB	DC - 2.4 GHz	dB	—	—	$\pm(.3 + 5\%$ of atten setting)
		DC - 2.4 GHz	dB	—	—	$\pm(.5 + 8\%$ of atten setting)
VSWR	Full Range	DC - 2.4 GHz	Ratio	—	1.8:1	2:1
Switching Speed	50% Cntl to 90%/10% RF 10% to 90% or 90% to 10%	—	ns	—	75	—
		—	ns	—	20	—
1 dB Compression	—	50 MHz	dBm	—	+21	—
		0.5 - 2.4 GHz	dBm	—	+24	—
Input IP_3	Two-tone inputs up to +5 dBm	50 MHz	dB	—	+35	—
		0.5-2.4 GHz	dB	—	+48	—
V_{CC}	—	—	V	4.75	5.0	5.25
V_{IL} V_{IH}	LOW-level input voltage HIGH-level input voltage	—	V	0.0	—	0.8
		—	V	2.0	—	5.0
lin (Input Leakage Current)	$V_{in} = V_{CC}$ or GND	—	μA	-1.0	—	1.0
I_{CC}^4	V_{CC} min to max, Logic "0" or "1"	—	mA	—	6	10
Turn-on Current ⁵	For guaranteed start-up	—	mA	—	—	125
ΔI_{CC} (Additional Supply Current Per TTL Input Pin)	$V_{CC} = \text{Max}$, $V_{cntrl} = V_{CC} - 2.1 \text{ V}$	—	mA	—	—	1.0
Switching Noise	Generated from DC-DC Converter with recommended capacitors	3.5 MHz	dBm	—	-93	—
Thermal Resistance θ_{jc}	—	—	$^\circ\text{C/W}$	—	15	—

- During turn-on, the device requires an initial "Turn-on Current". Once operational, I_{CC} will drop to the specified levels.
- The DC-DC converter is guaranteed to start in 100 μs as long as the power supplies can provide a minimum of 100 mA "Turn-on Current".

Absolute Maximum Ratings^{6,7}

Parameter	Absolute Maximum
Max. Input Power	+27 dBm
	+34 dBm
V_{CC}	$-0.5\text{V} \leq V_{CC} \leq +6.0\text{V}$
V_{in}^8	$-0.5\text{V} \leq V_{in} \leq V_{CC} + 0.5\text{V}$
Operating Temperature	-40°C to $+85^\circ\text{C}$
Storage Temperature	-65°C to $+125^\circ\text{C}$

- Exceeding any one or combination of these limits may cause permanent damage to this device.
- M/A-COM does not recommend sustained operation near these survivability limits.
- Standard CMOS TTL interface, latch-up will occur if logic signal is applied prior to power supply.

Recommended PCB Configuration⁹

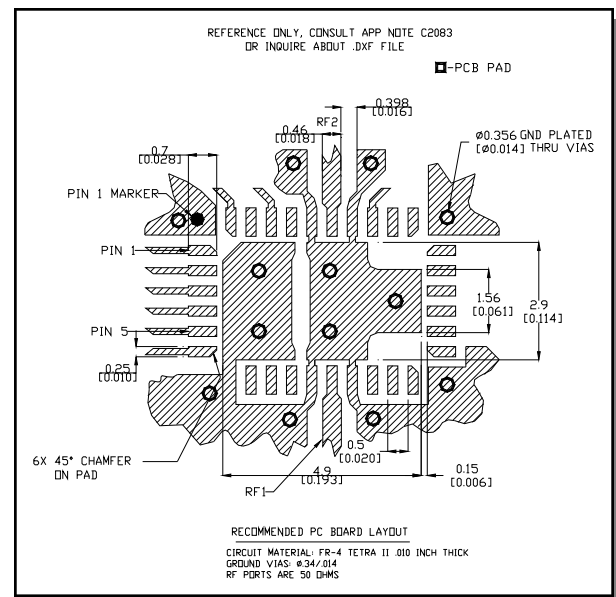

- Application Note S2083 is available on line at www.macom.com.

Handling Procedures

Please observe the following precautions to avoid damage:

Static Sensitivity

Gallium Arsenide Integrated Circuits are sensitive to electrostatic discharge (ESD) and can be damaged by static electricity. Proper ESD control techniques should be used when handling these devices.

Moisture Sensitivity

The MSL rating for this part is defined as Level 2 per IPC/JEDEC J-STD-020. Parts shall be stored and/or baked as required for MSL Level 2 parts.

Truth Table (Digital Attenuator)

C32	C16	C8	C4	C2	C1	Attenuation
0	0	0	0	0	0	Loss, Reference
0	0	0	0	0	1	1.0 dB
0	0	0	0	1	0	2.0 dB
0	0	0	1	0	0	4.0 dB
0	0	1	0	0	0	8.0 dB
0	1	0	0	0	0	16.0 dB
1	0	0	0	0	0	32.0 dB
1	1	0	0	1	0	50.0 dB

0 = TTL Low; 1 = TTL High

Typical Performance Curves

Insertion Loss

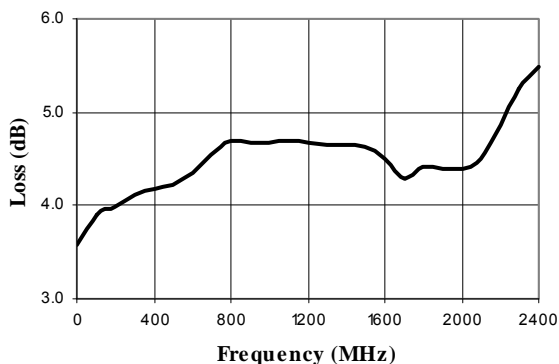

VSWR @ Insertion Loss

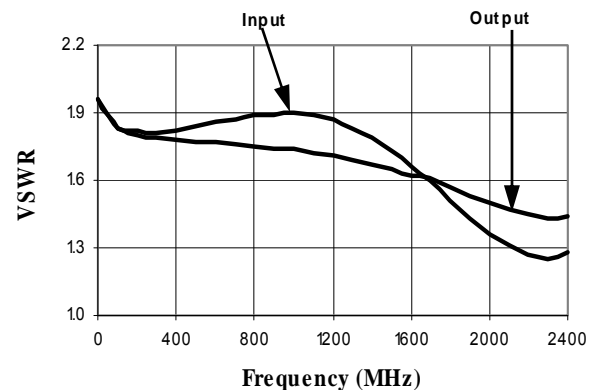

Attenuation Error, 1 dB Bit

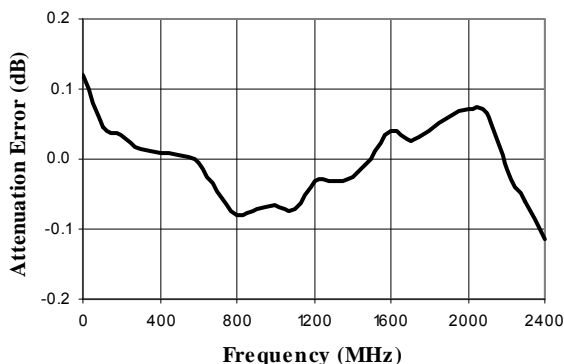

Attenuation Error, 2 dB Bit

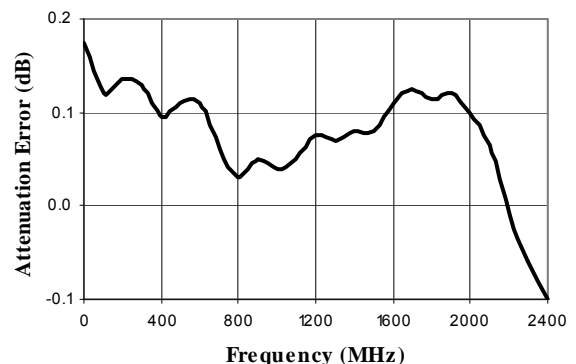

Typical Performance Curves

Attenuation Error, 4 dB Bit

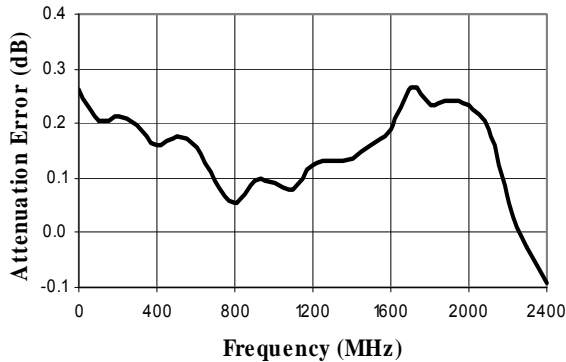

Attenuation Error, 8 dB Bit

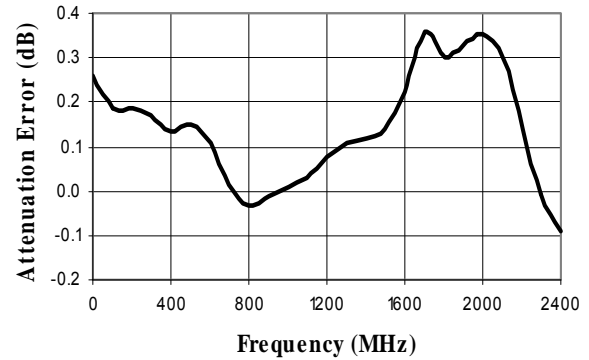

Attenuation Error, 16 dB Bit

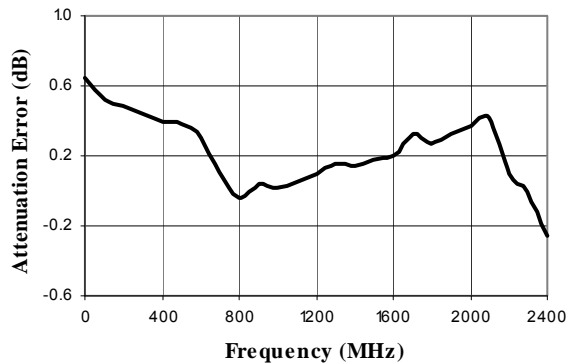

Attenuation Error, 32 dB Bit

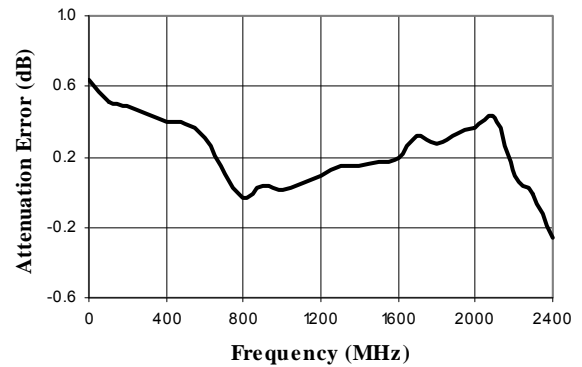

Attenuation Error, Max. Attenuation

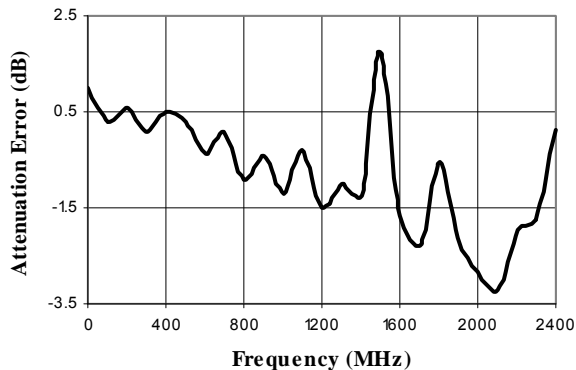

VSWR, 1 dB Bit

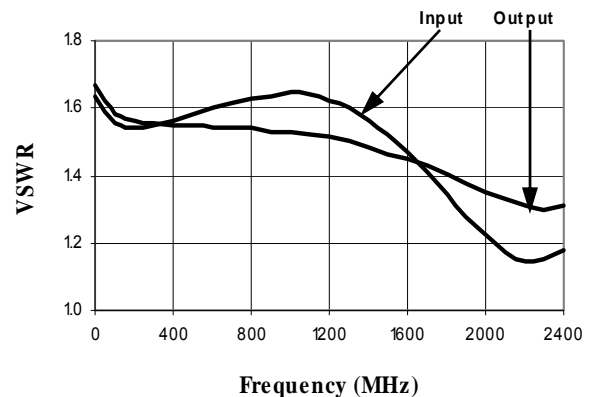

Typical Performance Curves

VSWR, 2 dB Bit

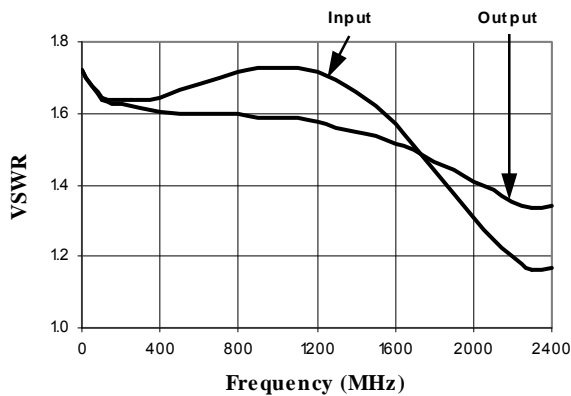

VSWR, 4 dB Bit

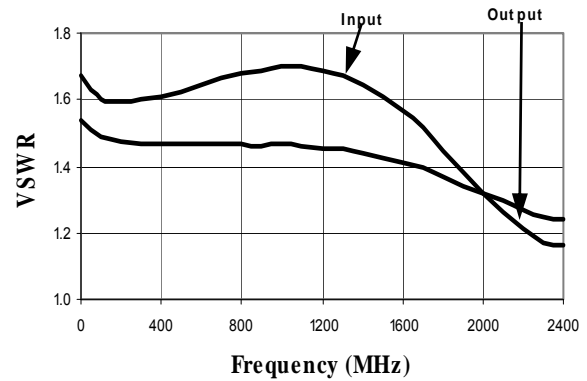

VSWR, 8 dB Bit

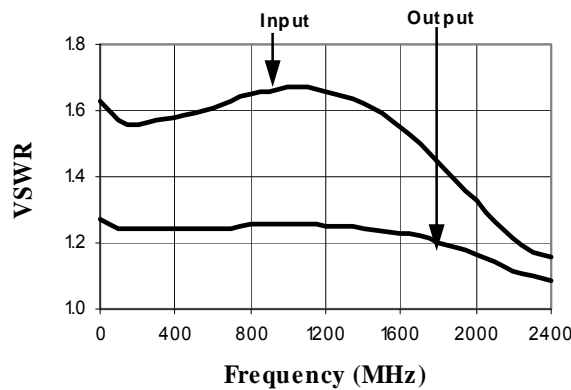

VSWR, 16 dB Bit

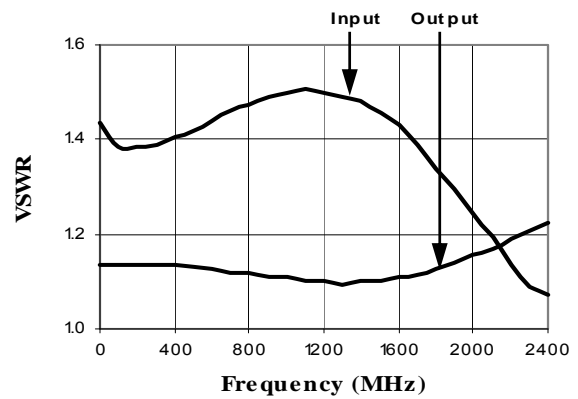

VSWR, 32 dB Bit

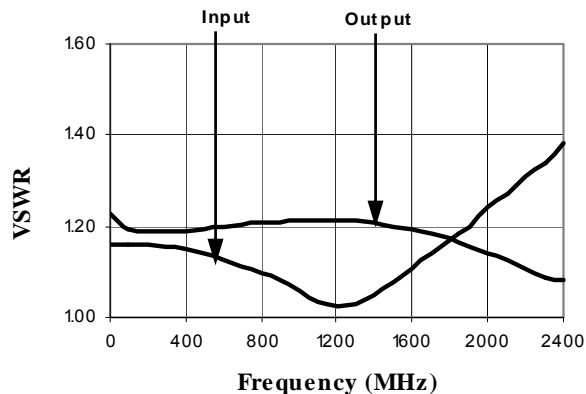

VSWR, Maximum attenuation

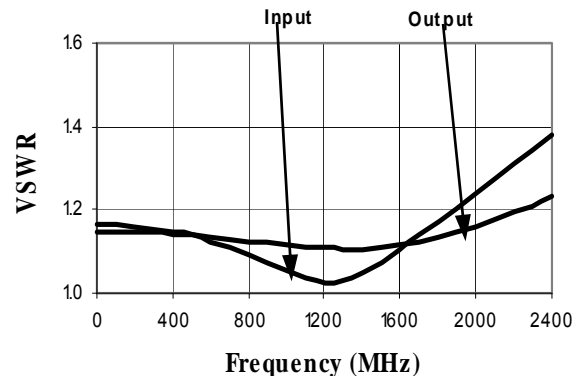

Typical Performance Curves

Maximum IP3 over Temperature Range and Attenuation @ 50 MHz

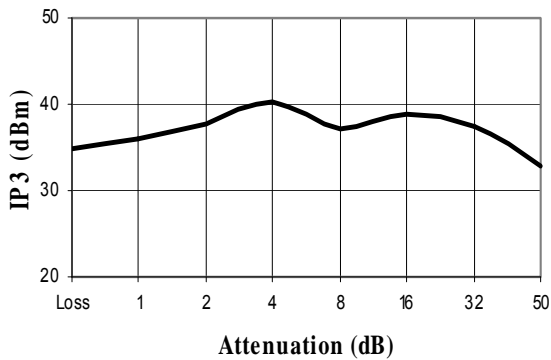

Maximum IP3 over Temperature Range and Attenuation @ 950 MHz

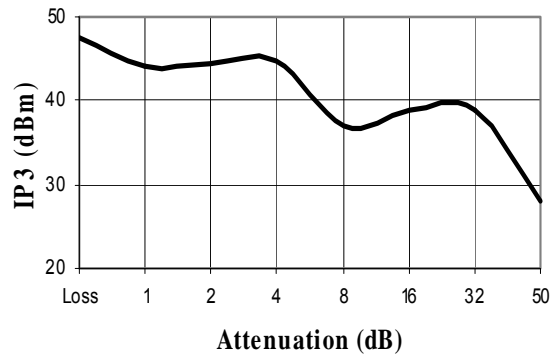

Maximum IP3 over Temperature Range and Attenuation @ 1900 MHz

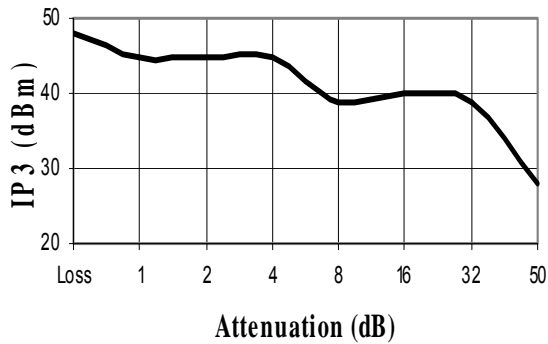

**CSP-1, Lead-Free 4 x 6 mm, 32-lead
PQFN†**

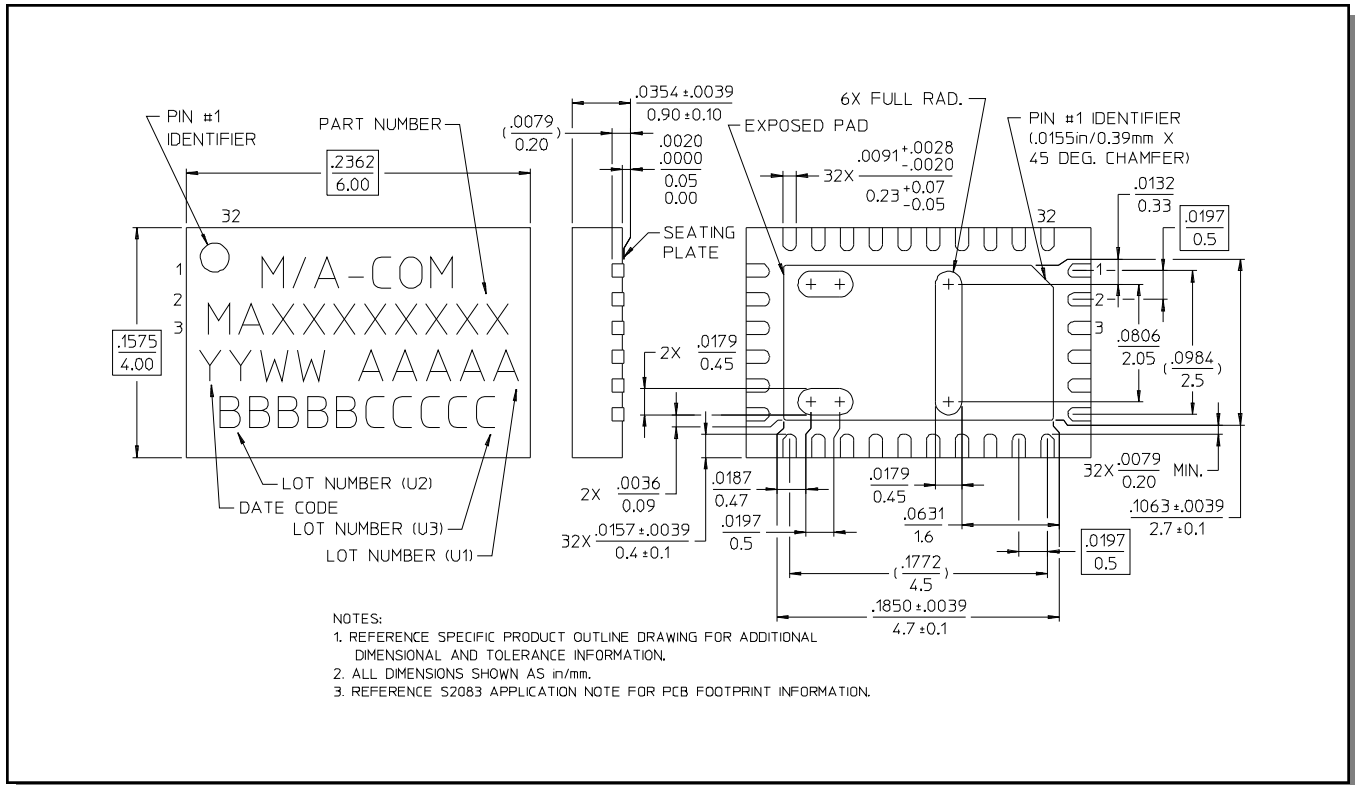

† Reference Application Note M538 for lead-free solder reflow recommendations.

Данный компонент на территории Российской Федерации

Вы можете приобрести в компании MosChip.

Для оперативного оформления запроса Вам необходимо перейти по данной ссылке:

<http://moschip.ru/get-element>

Вы можете разместить у нас заказ для любого Вашего проекта, будь то серийное производство или разработка единичного прибора.

В нашем ассортименте представлены ведущие мировые производители активных и пассивных электронных компонентов.

Нашей специализацией является поставка электронной компонентной базы двойного назначения, продукции таких производителей как XILINX, Intel (ex.ALTERA), Vicor, Microchip, Texas Instruments, Analog Devices, Mini-Circuits, Amphenol, Glenair.

Сотрудничество с глобальными дистрибьюторами электронных компонентов, предоставляет возможность заказывать и получать с международных складов практически любой перечень компонентов в оптимальные для Вас сроки.

На всех этапах разработки и производства наши партнеры могут получить квалифицированную поддержку опытных инженеров.

Система менеджмента качества компании отвечает требованиям в соответствии с ГОСТ Р ИСО 9001, ГОСТ РВ 0015-002 и ЭС РД 009

Офис по работе с юридическими лицами:

105318, г.Москва, ул.Щербаковская д.3, офис 1107, 1118, ДЦ «Щербаковский»

Телефон: +7 495 668-12-70 (многоканальный)

Факс: +7 495 668-12-70 (доб.304)

E-mail: info@moschip.ru

Skype отдела продаж:

moschip.ru

moschip.ru_4

moschip.ru_6

moschip.ru_9