

## IR Receiver Modules for Remote Control Systems

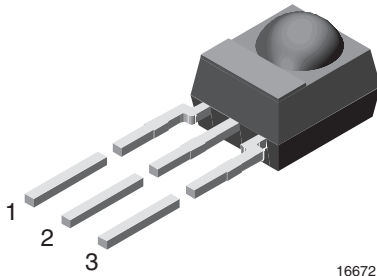

16672

### MECHANICAL DATA

#### Pinning for TSOP44..., TSOP48...:

 1 = OUT, 2 = GND, 3 =  $V_S$ 

#### Pinning for TSOP22..., TSOP24...:

 1 = OUT, 2 =  $V_S$ , 3 = GND

### FEATURES

- Low supply current
- Photo detector and preamplifier in one package
- Internal filter for PCM frequency
- Improved shielding against EMI
- Supply voltage: 2.5 V to 5.5 V
- Improved immunity against ambient light
- Insensitive to supply voltage ripple and noise
- Material categorization:  
for definitions of compliance please see [www.vishay.com/doc?99912](http://www.vishay.com/doc?99912)



### DESCRIPTION

The TSOP22..., TSOP48..., TSOP24.. and TSOP44.. series are miniaturized IR receiver modules for infrared remote control systems. A PIN diode and a preamplifier are assembled on lead frame, the epoxy package contains an IR filter.

The demodulated output signal can be directly connected to a microprocessor for decoding.

The TSOP24..., TSOP44.. are optimized to suppress almost all spurious pulses from energy saving lamps like CFLs. The AGC4 used in the TSOP24.. and TSOP44.. may suppress some data signals. The TSOP22..., TSOP48.. are legacy products for all common IR remote control data formats. Between these four receiver types, the TSOP24..., TSOP44.. are preferred. Customers should initially try the TSOP24..., TSOP44 in their design.

These components have not been qualified according to automotive specifications.

PARTS TABLE					
AGC		LEGACY, FOR LONG BURST REMOTE CONTROLS (AGC2)		RECOMMENDED FOR LONG BURST CODES (AGC4) (1)	
Carrier frequency	30 kHz	TSOP4830	TSOP2230	TSOP4430	TSOP2430
	33 kHz	TSOP4833	TSOP2233	TSOP4433	TSOP2433
	36 kHz	TSOP4836	TSOP2236	TSOP4436 (2)(3)(4)	TSOP2436 (2)(3)(4)
	38 kHz	TSOP4838	TSOP2238	TSOP4438 (5)(6)(7)	TSOP2438 (5)(6)(7)
	40 kHz	TSOP4840	TSOP2240	TSOP4440	TSOP2440
	56 kHz	TSOP4856	TSOP2256	TSOP4456 (7)(8)	TSOP2456 (7)(8)
Package	Mold				
Pinning	1 = OUT, 2 = GND, 3 = $V_S$	1 = OUT, 2 = $V_S$ , 3 = GND	1 = OUT, 2 = GND, 3 = $V_S$	1 = OUT, 2 = $V_S$ , 3 = GND	
Dimensions (mm)	6.0 W x 6.95 H x 5.6 D				
Mounting	Leaded				
Application	Remote control				
Best remote control code	(2) RC-5 (3) RC-6 (4) Panasonic (5) NEC (6) Sharp (7) r-step (8) Thomson RCA				

### Note

(1) We advise try AGC4 first if the burst length is unknown.

**BLOCK DIAGRAM**

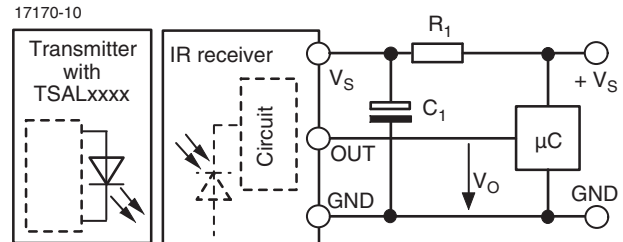
**APPLICATION CIRCUIT**

The external components  $R_1$  and  $C_1$  are optional to improve the robustness against electrical overstress (typical values are  $R_1 = 100 \Omega$ ,  $C_1 = 0.1 \mu\text{F}$ ).

**ABSOLUTE MAXIMUM RATINGS**

PARAMETER	TEST CONDITION	SYMBOL	VALUE	UNIT
Supply voltage		$V_S$	-0.3 to +6	V
Supply current		$I_S$	5	mA
Output voltage		$V_O$	-0.3 to 5.5	V
Voltage at output to supply		$V_S - V_O$	-0.3 to $(V_S + 0.3)$	V
Output current		$I_O$	5	mA
Junction temperature		$T_j$	100	$^{\circ}\text{C}$
Storage temperature range		$T_{\text{stg}}$	-25 to +85	$^{\circ}\text{C}$
Operating temperature range		$T_{\text{amb}}$	-25 to +85	$^{\circ}\text{C}$
Power consumption	$T_{\text{amb}} \leq 85 \text{ }^{\circ}\text{C}$	$P_{\text{tot}}$	10	mW
Soldering temperature	$t \leq 10 \text{ s}$ , 1 mm from case	$T_{\text{sd}}$	260	$^{\circ}\text{C}$

**Note**

- Stresses beyond those listed under "Absolute Maximum Ratings" may cause permanent damage to the device. This is a stress rating only and functional operation of the device at these or any other conditions beyond those indicated in the operational sections of this specification is not implied. Exposure to absolute maximum rating conditions for extended periods may affect the device reliability.

**ELECTRICAL AND OPTICAL CHARACTERISTICS** ( $T_{\text{amb}} = 25 \text{ }^{\circ}\text{C}$ , unless otherwise specified)

PARAMETER	TEST CONDITION	SYMBOL	MIN.	TYP.	MAX.	UNIT
Supply current	$E_v = 0$ , $V_S = 5 \text{ V}$	$I_{\text{SD}}$	0.55	0.7	0.9	mA
	$E_v = 40 \text{ klx}$ , sunlight	$I_{\text{SH}}$		0.8		mA
Supply voltage		$V_S$	2.5		5.5	V
Transmission distance	$E_v = 0$ , test signal see fig. 1, IR diode TSAL6200, $I_F = 200 \text{ mA}$	$d$		45		m
Output voltage low	$I_{\text{OSL}} = 0.5 \text{ mA}$ , $E_e = 0.7 \text{ mW/m}^2$ , test signal see fig. 1	$V_{\text{OSL}}$			100	mV
Minimum irradiance	Pulse width tolerance: $t_{\text{pi}} - 5/f_o < t_{\text{po}} < t_{\text{pi}} + 6/f_o$ , test signal see fig. 1	$E_e \text{ min.}$		0.12	0.25	$\text{mW/m}^2$
Maximum irradiance	$t_{\text{pi}} - 5/f_o < t_{\text{po}} < t_{\text{pi}} + 6/f_o$ , test signal see fig. 1	$E_e \text{ max.}$	50			$\text{W/m}^2$
Directivity	Angle of half transmission distance	$\phi_{1/2}$		$\pm 45$		deg

**TYPICAL CHARACTERISTICS** ( $T_{amb} = 25\text{ }^{\circ}\text{C}$ , unless otherwise specified)



Fig. 1 - Output Active Low

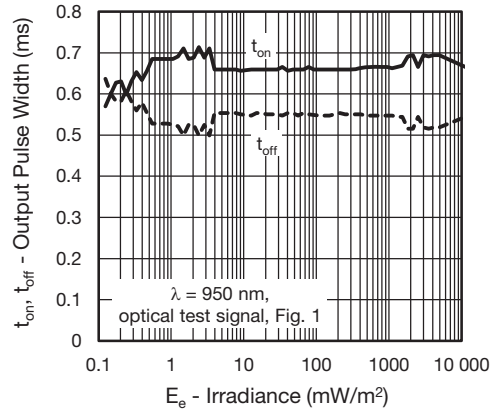

Fig. 4 - Output Pulse Diagram

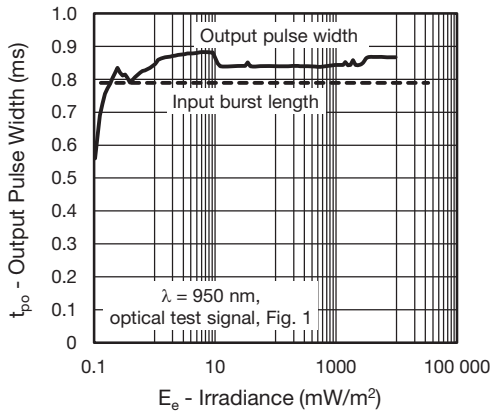

Fig. 2 - Pulse Length and Sensitivity in Dark Ambient

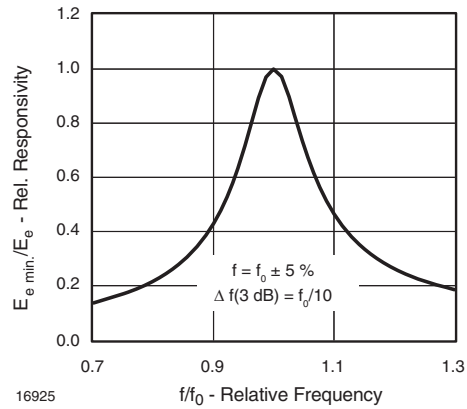

Fig. 5 - Frequency Dependence of Responsivity



Fig. 3 - Output Function

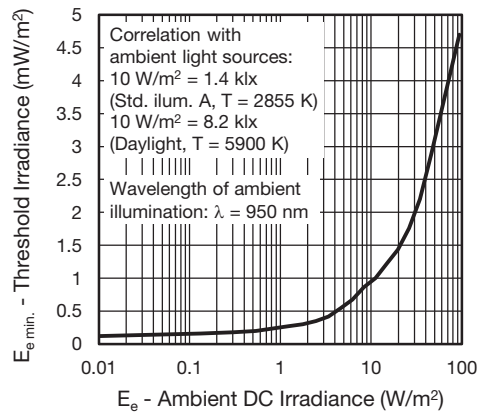

Fig. 6 - Sensitivity in Bright Ambient

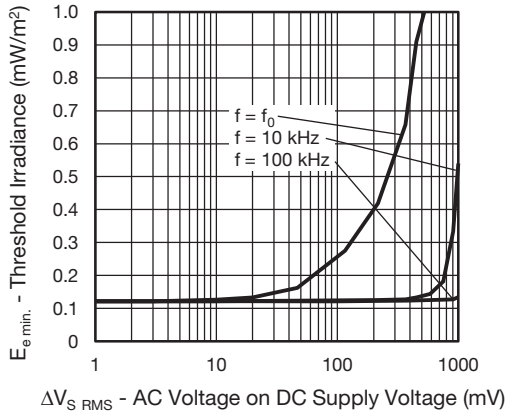

Fig. 7 - Sensitivity vs. Supply Voltage Disturbances

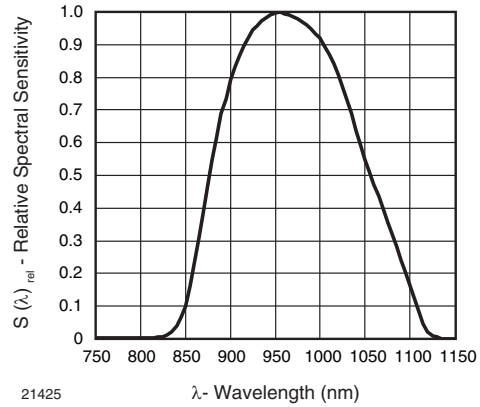

Fig. 10 - Relative Spectral Sensitivity vs. Wavelength

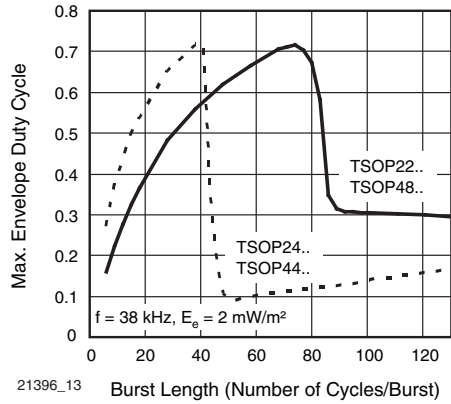

Fig. 8 - Max. Envelope Duty Cycle vs. Burst Length

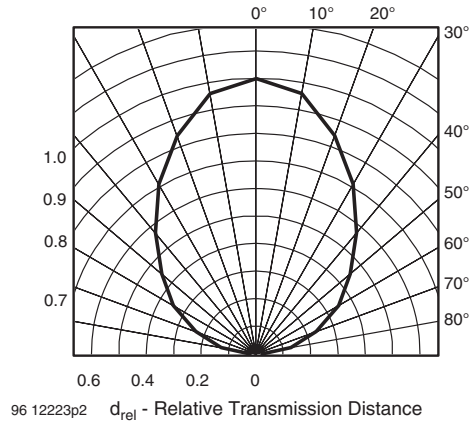

Fig. 11 - Horizontal Directivity

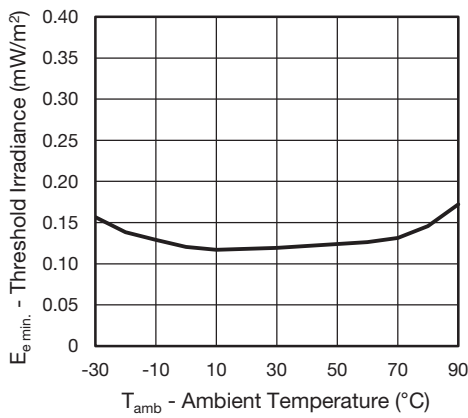

Fig. 9 - Sensitivity vs. Ambient Temperature

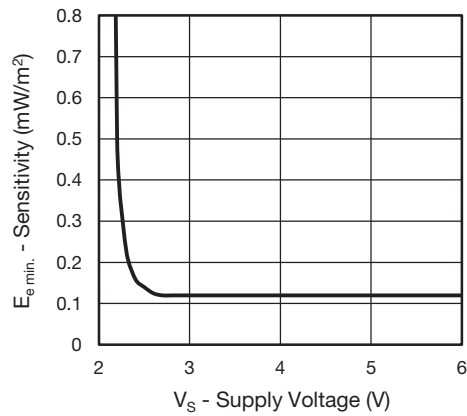

Fig. 12 - Sensitivity vs. Supply Voltage

## SUITABLE DATA FORMAT

This series is designed to suppress spurious output pulses due to noise or disturbance signals. The devices can distinguish data signals from noise due to differences in frequency, burst length, and envelope duty cycle. The data signal should be close to the device's band-pass center frequency (e.g. 38 kHz) and fulfill the conditions in the table below.

When a data signal is applied to the product in the presence of a disturbance, the sensitivity of the receiver is automatically reduced by the AGC to insure that no spurious pulses are present at the receiver's output. Some examples which are suppressed are:

- DC light (e.g. from tungsten bulbs sunlight)
- Continuous signals at any frequency
- Strongly or weakly modulated patterns from fluorescent lamps with electronic ballasts (see figure 13 or figure 14).

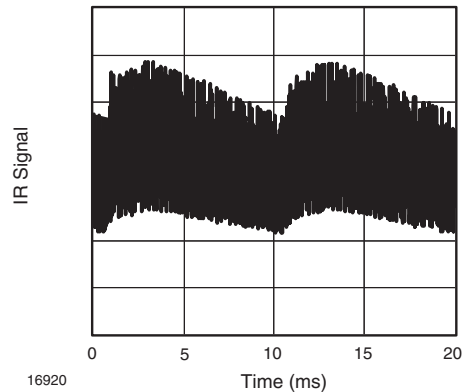

Fig. 13 - IR Disturbance from Fluorescent Lamp with Low Modulation

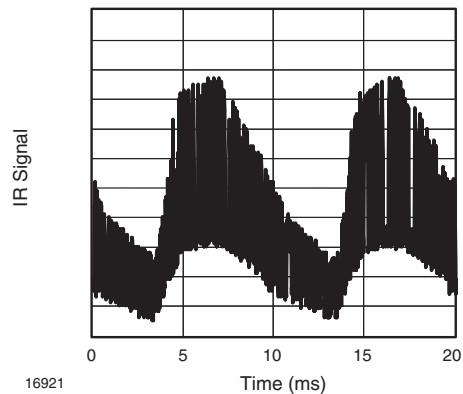

Fig. 14 - IR Disturbance from Fluorescent Lamp with High Modulation

	TSOP22..., TSOP48..	TSOP24..., TSOP44..
Minimum burst length	10 cycles/burst	10 cycles/burst
After each burst of length a minimum gap time is required of	10 to 70 cycles ≥ 12 cycles	10 to 35 cycles ≥ 12 cycles
For bursts greater than a minimum gap time in the data stream is needed of	70 cycles > 4 x burst length	35 cycles > 10 x burst length
Maximum number of continuous short bursts/second	800	1300
NEC code	yes	preferred
RC5/RC6 code	yes	preferred
Thomson 56 kHz code	yes	preferred
Sharp code	yes	preferred
Suppression of interference from fluorescent lamps	Most common disturbance patterns are suppressed	Even extreme disturbance patterns are suppressed

### Notes

- For data formats with short bursts please see the datasheet of TSOP23..., TSOP43..
- Best choice of AGC for some popular IR-codes:
  - TSOP4436, TSOP2436: RC-5, RC-6, Panasonic
  - TSOP4438, TSOP2438: NEC, Sharp, r-step
  - TSOP4456, TSOP2456: r-step, Thomson RCA
- For SIRCS 15 and 20 bit, Sony 12 bit IR-codes, please see the datasheet for TSOP4S40, TSOP2S40



## PACKAGE DIMENSIONS in millimeters



Drawing-No.: 6.550-5169.01-4  
Issue: 9; 03.11.10  
13655



## IR Receiver Modules for Remote Control Systems

Vishay offers stock molded IR receivers in four different packages:

- Loose packed in tubes, mounted on tape for reel or ammopack, or packed bulk in plastic bags.
- Vishay IR receiver with metal holders are packed in plastic trays. Vishay IR receiver with plastic holders are packed in plastic tubes.



### FEATURES

- Material categorization:  
For definitions of compliance please see [www.vishay.com/doc?99912](http://www.vishay.com/doc?99912)



### AVAILABLE FOR

- TSOP348..
- TSOP344..
- TSOP343..
- TSOP341..
- TSOP44...
- TSOP48...
- TSOP41...
- TSOP324..
- TSOP323..
- TSOP322..
- TSOP321..
- TSOP24...
- TSOP22...
- TSOP21...
- TSOP345..
- TSOP325..
- TSOP43...
- TSOP23...
- TSSP4..
- TSMP4..

### LOOSE PACKED IN TUBE

### ORDERING INFORMATION



O = for IR receiver applications  
M = for repeater/learning applications  
S = for sensor applications

#### Note

- d = "digit", please consult the list of available devices create a valid part number.

Example: TSOP4838

### PACKAGING QUANTITY

- 90 pieces per tube
- 24 tubes per carton

### PACKAGING DIMENSIONS in millimeters

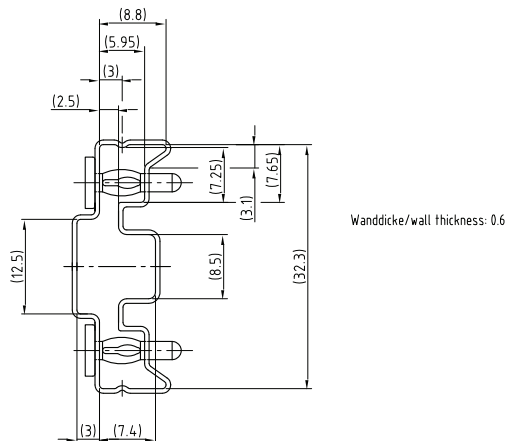

Drawing-No.: 9.700-5185.0-4  
Rev. 13; Date: 20.11.03  
20273-1

Druck / Printing for tubes  
1.400-5548.0-3 Version 1



## TAPE AND REEL/AMMOPACK

Up to 3 consecutive components may be missing if the gap is followed by at least 6 components. A maximum of 0.5 % of the components per reel quantity may be missing. At least 5 empty positions are present at the start and the end of the tape to enable insertion.

Tensile strength of the tape: > 15 N

Pulling force in the plane of the tape, at right angles to the reel: > 5 N

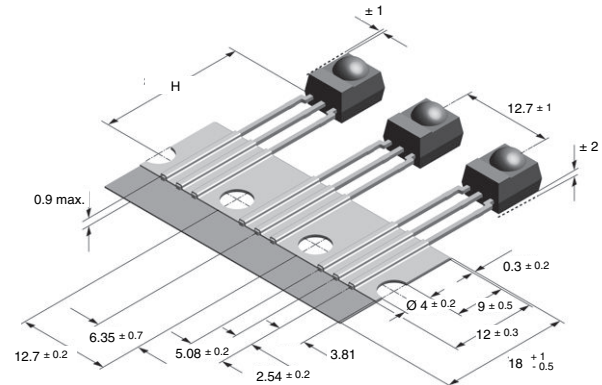

VERSION	DIMENSION "H"
BS	20 ± 0.5
PS	23.3 ± 0.5
OS	26 ± 0.5

## ORDERING INFORMATION

T S d P

O = for IR receiver applications  
 M = for repeater/learning applications  
 S = for sensor applications

d d d d d

2 or 3 digit product series    2 digit frequency

S S 1

SS1 for T and R, bulk or ammpack

d d d d

dd = BS, PS or OS    Tape and reel    dd = 12 or 21

Z

Ammpack

### Note

- d = "digit", please consult the list of available devices create a valid part number.

Example: **TSOP4838SS1BS12**

**TSOP2238SS1BS12Z**

## PACKAGING QUANTITY

- 1000 pieces per reel
- 1000 pieces per ammpack





## BULK PACKAGING

The option "BK" signifies bulk packaging in conductive plastic bags. A maximum of 0.3 % of the components per box may be missing.

## ORDERING INFORMATION

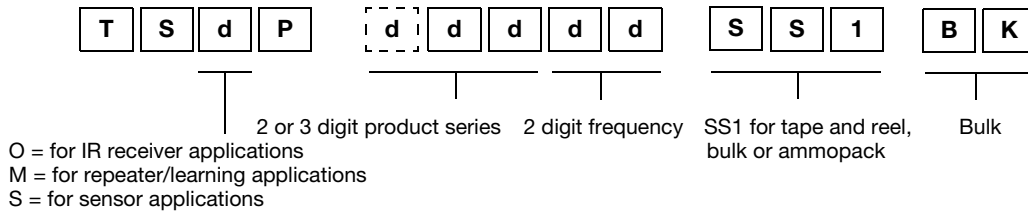

### Note

- d = "digit", please consult the list of available devices create a valid part number.

**EXAMPLE: TSOP4838SS1BK**  
**TSOP2238SS1BK**

## PACKAGING QUANTITY

- 250 pieces per bag (each bag is individually boxed)
- 6 bags per carton

## OUTER PACKAGING

CARTON BOX DIMENSIONS in millimeters			
<b>KINDS OF CARTON BOX</b>	<b>THICKNESS</b>	<b>WIDTH</b>	<b>LENGTH</b>
<b>Packaging Plastic Tubes</b> (Normal/auxiliary devices)	80	150	600
<b>Packaging Plastic Trays</b> (Devices with metal holders)	120	290	490
<b>Tape and Reel Box</b> (Taping in reels)	400	310	410
<b>Ammo-Box</b> (Zigzag taping)	50	130	350



## Disclaimer

ALL PRODUCT, PRODUCT SPECIFICATIONS AND DATA ARE SUBJECT TO CHANGE WITHOUT NOTICE TO IMPROVE RELIABILITY, FUNCTION OR DESIGN OR OTHERWISE.

Vishay Intertechnology, Inc., its affiliates, agents, and employees, and all persons acting on its or their behalf (collectively, "Vishay"), disclaim any and all liability for any errors, inaccuracies or incompleteness contained in any datasheet or in any other disclosure relating to any product.

Vishay makes no warranty, representation or guarantee regarding the suitability of the products for any particular purpose or the continuing production of any product. To the maximum extent permitted by applicable law, Vishay disclaims (i) any and all liability arising out of the application or use of any product, (ii) any and all liability, including without limitation special, consequential or incidental damages, and (iii) any and all implied warranties, including warranties of fitness for particular purpose, non-infringement and merchantability.

Statements regarding the suitability of products for certain types of applications are based on Vishay's knowledge of typical requirements that are often placed on Vishay products in generic applications. Such statements are not binding statements about the suitability of products for a particular application. It is the customer's responsibility to validate that a particular product with the properties described in the product specification is suitable for use in a particular application. Parameters provided in datasheets and/or specifications may vary in different applications and performance may vary over time. All operating parameters, including typical parameters, must be validated for each customer application by the customer's technical experts. Product specifications do not expand or otherwise modify Vishay's terms and conditions of purchase, including but not limited to the warranty expressed therein.

Except as expressly indicated in writing, Vishay products are not designed for use in medical, life-saving, or life-sustaining applications or for any other application in which the failure of the Vishay product could result in personal injury or death. Customers using or selling Vishay products not expressly indicated for use in such applications do so at their own risk. Please contact authorized Vishay personnel to obtain written terms and conditions regarding products designed for such applications.

No license, express or implied, by estoppel or otherwise, to any intellectual property rights is granted by this document or by any conduct of Vishay. Product names and markings noted herein may be trademarks of their respective owners.

## Material Category Policy

**Vishay Intertechnology, Inc. hereby certifies that all its products that are identified as RoHS-Compliant fulfill the definitions and restrictions defined under Directive 2011/65/EU of The European Parliament and of the Council of June 8, 2011 on the restriction of the use of certain hazardous substances in electrical and electronic equipment (EEE) - recast, unless otherwise specified as non-compliant.**

**Please note that some Vishay documentation may still make reference to RoHS Directive 2002/95/EC. We confirm that all the products identified as being compliant to Directive 2002/95/EC conform to Directive 2011/65/EU.**

**Vishay Intertechnology, Inc. hereby certifies that all its products that are identified as Halogen-Free follow Halogen-Free requirements as per JEDEC JS709A standards. Please note that some Vishay documentation may still make reference to the IEC 61249-2-21 definition. We confirm that all the products identified as being compliant to IEC 61249-2-21 conform to JEDEC JS709A standards.**

## Данный компонент на территории Российской Федерации

### Вы можете приобрести в компании MosChip.

Для оперативного оформления запроса Вам необходимо перейти по данной ссылке:

<http://moschip.ru/get-element>

Вы можете разместить у нас заказ для любого Вашего проекта, будь то серийное производство или разработка единичного прибора.

В нашем ассортименте представлены ведущие мировые производители активных и пассивных электронных компонентов.

Нашей специализацией является поставка электронной компонентной базы двойного назначения, продукции таких производителей как XILINX, Intel (ex.ALTERA), Vicor, Microchip, Texas Instruments, Analog Devices, Mini-Circuits, Amphenol, Glenair.

Сотрудничество с глобальными дистрибьюторами электронных компонентов, предоставляет возможность заказывать и получать с международных складов практически любой перечень компонентов в оптимальные для Вас сроки.

На всех этапах разработки и производства наши партнеры могут получить квалифицированную поддержку опытных инженеров.

Система менеджмента качества компании отвечает требованиям в соответствии с ГОСТ Р ИСО 9001, ГОСТ РВ 0015-002 и ЭС РД 009

### Офис по работе с юридическими лицами:

105318, г.Москва, ул.Щербаковская д.3, офис 1107, 1118, ДЦ «Щербаковский»

Телефон: +7 495 668-12-70 (многоканальный)

Факс: +7 495 668-12-70 (доб.304)

E-mail: [info@moschip.ru](mailto:info@moschip.ru)

Skype отдела продаж:

moschip.ru

moschip.ru\_4

moschip.ru\_6

moschip.ru\_9