

# Series 02

## Characteristics

The robust Series 02 is especially suited for:

- Flush design

The rectangular construction (24x36 mm) provides large surfaces for illumination and labelling.

## Functions

The Series 02 incorporates the following functions:

- Indicator
- Pushbutton
- Illuminated pushbutton
- Keylock switch
- Buzzer

## Market segments

The EAO Series 02 is especially suited for applications in the segments:

- Ship building
- Panel building

Please refer to the EAO website to obtain detailed information regarding this series [www.products.eao.com](http://www.products.eao.com)  
Configure a product to your exact needs and request a quotation.





**Overview****Flush design**

Indicator	4
Buzzer	5
Pushbutton	6
Illuminated pushbutton	7
Mushroom-head pushbutton	8
Keylock switch	9
Mushroom-head keylock pushbutton	10

**Accessories** 11**Technical data** 21**Marking** 23**Application guidelines** 24**Index** 25

# 02 Flush design

## Indicator, IP 40



Product can differ from the current configuration.



Dimensions [mm]

### Additional Information

- For front dimension 24 x 36 mm
- For indicator 02-07x.00x can only filament lamps be used (no LEDs)
- For LED element fitting information see chapter «Application guidelines»
- Take note of heat generating



Mounting cut-outs [mm]

### Equipment consisting of (schematic overview)



Each article number listed below includes all the black components shown in the 3D-drawing.

To obtain a complete unit, please select the red components from the pages shown.

Product attribute	Behind panel depth	Terminal	Part No.	Wiring diagram	Weight
 <p><b>Indicator actuator</b> without serie resistor, for LED or filament lamp</p>	60 mm	Screw	<b>02-021.001</b>	1	0.030 kg
 <p><b>Indicator actuator</b> with built-in lamp series resistor, 240 VAC/DC to 48 V, 25 mA, for filament lamp</p>	84 mm	Screw	<b>02-070.001</b>	1	0.045 kg
with built-in lamp series resistor, 110 VAC/DC to 48 V, 25 mA, for filament lamp	84 mm	Screw	<b>02-071.001</b>	1	0.045 kg
with built-in lamp series resistor, 125 VAC/DC to 48 V, 25 mA, for filament lamp	84 mm	Screw	<b>02-072.001</b>	1	0.045 kg
with built-in lamp series resistor and diode, 240 VAC/DC to 48 V, 25 mA, for filament lamp	84 mm	Screw	<b>02-073.001</b>	1	0.045 kg



## Buzzer, IP 40

### Equipment consisting of (schematic overview)



**Front bezel** page 13



**Buzzer**



**Fixing bezel**



Dimensions [mm]



Product can differ from the current configuration.

Each article number listed below includes all the black components shown in the 3D-drawing.

To obtain a complete unit, please select the red components from the pages shown.



Mounting cut-outs [mm]

### Additional Information

- For front dimension 24 x 36 mm
- Further information in chapter «Technical Data»

Operating voltage	Front cap	Terminal	Part No.	Wiring diagram	Weight
 <p><b>Buzzer</b></p>					
10 ... 55 VAC, 10 ... 75 VDC	Pastic black	Screw	<b>02-810.001</b>	1	0.060 kg



# 02 Flush design

## Pushbutton, IP 40



Product can differ from the current configuration.



Dimensions [mm]

### Additional Information

- For front dimension 24 x 36 mm



Mounting cut-outs [mm]

### Equipment consisting of (schematic overview)



Each article number listed below includes all the black components shown in the 3D-drawing.

*To obtain a complete unit, please select the red components from the pages shown.*

Contacts	Switching action	Terminal	Part No.	Wiring diagram	Weight
	A	Screw	<b>02-611.011</b>	1	0.045 kg
	C	Screw	<b>02-613.011</b>	2	0.045 kg
2 C	A	Screw	<b>02-612.011</b>	3	0.050 kg
	C	Screw	<b>02-614.011</b>	4	0.050 kg
	B - C	Screw	<b>02-615.011</b>	5	0.050 kg

Contacts: C = Changeover

Switching action: B = Momentary, C = Maintain



## Illuminated pushbutton, IP 40

### Equipment consisting of (schematic overview)



**Front bezel** page 13



**Lens** page 11



**LED** page 17



**Actuator**



**Fixing bezel**

Each article number listed below includes all the black components shown in the 3D-drawing.

To obtain a complete unit, please select the red components from the pages shown.

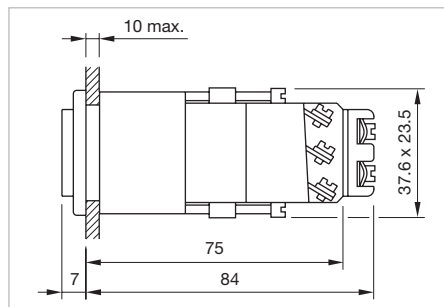

Dimensions [mm] [mm]

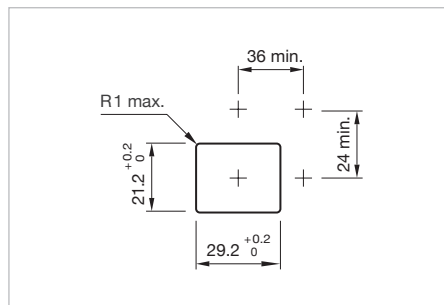

Mounting cut-outs [mm]



Product can differ from the current configuration.

### Additional Information

- For front dimension 24 x 36 mm
- For LED element fitting information see chapter «Application guidelines»

Contacts	Switching action	Terminal	Part No.	Wiring diagram	Gewicht
 <p><b>Illuminated pushbutton actuator</b></p>					
1 C	B	Screw	<b>02-616.011</b>	1	0.050 kg
	C	Screw	<b>02-618.011</b>	2	0.050 kg
2 C	B	Screw	<b>02-617.011</b>	3	0.055 kg
	C	Screw	<b>02-619.011</b>	4	0.055 kg
	B - C	Screw	<b>02-620.011</b>	5	0.055 kg

Contacts: C = Changeover

Switching action: B = Momentary, C = Maintain

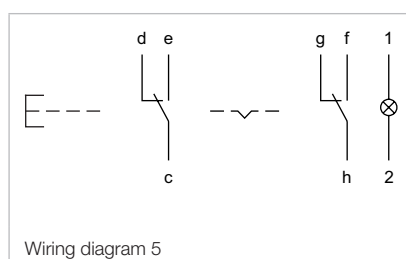

# 02 Flush design

## Mushroom-head pushbutton, IP 40



Product can differ from the current configuration.



Dimensions [mm]

### Additional Information

- For front dimension 24 x 36 mm
- Use only flush front bezel



Mounting cut-outs[mm]

### Equipment consisting of (schematic overview)



**Mushroom-head cap** page 11



**Front bezel** page 13



**Actuator**



**Fixing sleeve**

Each Part Number listed below includes all the black components shown in the 3D-drawing.

To obtain a complete unit, please select the red components from the pages shown.

Contacts	Switching action	Terminal	Part No.	Wiring diagram	Weight
 <b>Mushroom-head pushbutton actuator</b>					
1 C	B	Screw	<b>02-611.011</b>	1	0.045 kg
	C	Screw	<b>02-613.011</b>	2	0.045 kg
2 C	B	Screw	<b>02-612.011</b>	3	0.050 kg
	C	Screw	<b>02-614.011</b>	4	0.050 kg
	B - C	Screw	<b>02-615.011</b>	5	0.050 kg

Contacts: C = Changeover

Switching action: B = Momentary, C = Maintain





**Keylock switch 2 positions, IP 40**

**Equipment consisting of (schematic overview)**



**Front bezel** page 13



**Keylock front bezel** page 12



**Actuator**



**Fixing bezel**

Each article number listed below includes all the black components shown in the 3D-drawing.

To obtain a complete unit, please select the red components from the pages shown.



Dimensions [mm]



Product can differ from the current configuration.



Mounting cut-outs [mm]

**Additional Information**

- For front dimension 24 x 36 mm
- Front plastic grey
- Keylock number YB1
- After turning the key 90° clockwise, the switch can be operated
- In the unlocked switch positions always perform a momentary action
- Two keys are supplied with each key lock switch



Switching positions (A = Rest, B = Momentary)

Product attribute	Contacts	Switching angle	Key remove	Terminal	Part No.	Wiring diagram	Gewicht
							
<b>Schlüsselschalter-Vorsatz 2 Stellungen</b>							
A = lockable, actuated	2 C	B = 90°	A	Screw	<b>02-690.011</b>	1	0.055 kg
A = lockable, non-actuated or actuated	2 C	B = 90°	A	Screw	<b>02-692.011</b>	1	0.055 kg
A = lockable, non-actuated	2 C	B = 90°	A	Screw	<b>02-691.011</b>	1	0.055 kg

Contacts: C = Changeover



# 02 Flush design

## Keylock switch 2 positions, IP 40



Product can differ from the current configuration.



Dimensions [mm]

### Additional Information

- For front dimension 24 x 36 mm
- Front plastic grey
- Keylock number YB1
- After turning the key 90° clockwise, the switch can be operated
- In the unlocked switch positions always perform a momentary action
- Two keys are supplied with each key lock switch



Mounting cut-outs [mm]

### Equipment consisting of (schematic overview)



**Front bezel** page 13



**Keylock front bezel**



**Actuator**



**Fixing bezel**

Each article number listed below includes all the black components shown in the 3D-drawing.

*To obtain a complete unit, please select the red components from the pages shown.*



Switching positions (A = Rest, B = Momentary)

Product attribute	Contacts	Switching angle	Key remove	Terminal	Part No.	Wiring diagram	Gewicht
							
<b>Schlüsselschalter-Vorsatz 2 Stellungen</b>							
A = lockable, non-actuated, B = lockable, key not removable	2 C	B = 90°	A	Screw	<b>02-695.011</b>	1	0.055 kg
A = lockable, non-actuated or actuated; can be used with protective cover Part No. 22-925	2 C	B = 90°	A	Screw	<b>02-198.011</b>	1	0.055 kg

Contacts: C = Changeover

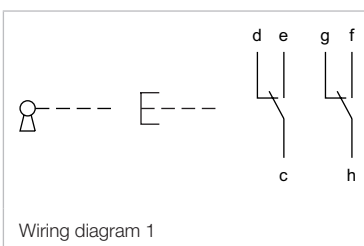

Front

Lens

Additional Information

- Material plastic

Product attribute	Dimension	Lens	Part No.	Weight		
 <p><b>Lens</b></p>	17.5 x 25.4 mm	illuminative, not suitable for film insert, ripped	smoked translucent	<b>02-901.1</b>	0.004 kg	
		red translucent	<b>02-901.2</b>	0.004 kg		
		orange translucent	<b>02-901.3</b>	0.004 kg		
		yellow translucent	<b>02-901.4</b>	0.004 kg		
		green translucent	<b>02-901.5</b>	0.004 kg		
		blue translucent	<b>02-901.6</b>	0.004 kg		
		colourless transparent	<b>02-901.7</b>	0.004 kg		
		white translucent	<b>02-901.9</b>	0.004 kg		
		illuminative, use holder for film insert	17.5 x 25.4 mm	red translucent	<b>02-902.2</b>	0.004 kg
				green translucent	<b>02-902.5</b>	0.004 kg
colourless transparent	<b>02-902.7</b>			0.004 kg		
non-illuminative	17.5 x 25.4 mm	black opaque	<b>02-901.0</b>	0.004 kg		
		grey opaque	<b>02-901.8</b>	0.004 kg		

Keylock front bezel

Additional Information

- Keylock number YB1
- Further lock numbers see «Technical data»

Product attribute	Dimension	Material	Colour	Part No.	Weight	
 <p><b>Keylock front bezel</b></p>	17.5 x 25.5 mm	Plastic	grey	<b>02-980.1</b>	0.002 kg	
	for keylock switch Part No. 02-695	17.5 x 25.5 mm	Plastic	grey	<b>02-982.1</b>	0.002 kg

# 02 Accessories

## Holder

### Additional Information

- For lens with film insert

Material	Colour	Optics	Part No.	Weight
 <b>Holder</b>				
Plastic	red	translucent	<b>02-908.2</b>	0.001 kg
	orange	translucent	<b>02-908.3</b>	0.001 kg
	yellow	translucent	<b>02-908.4</b>	0.001 kg
	green	translucent	<b>02-908.5</b>	0.001 kg
	blue	translucent	<b>02-908.6</b>	0.001 kg
	colourless	transparent	<b>02-908.7</b>	0.001 kg
	white	translucent	<b>02-908.9</b>	0.001 kg

## Diffusor plate

### Additional Information

- For lens with film insert

Part No.	Weight
 <b>Diffusor plate</b>	
<b>02-909</b>	0.001 kg

## Front bezel flush

### Additional Information

- Lens only removable with lens remover  
Part No. 02-905

Front bezel	Part No.	Weight
 <b>Front bezel flush, Front dimension 24 x 36 mm</b>		
Pastic black	<b>02-965.0</b>	0.001 kg

**Front bezel raised**

**Additional Information**

- Lens only removable with lens remover  
Part No. 98-969

Front bezel	Part No.	Weight
 <p><b>Front bezel raised, Front dimension 24 x 36 mm</b></p>		
Pastic black	<b>02-967.0</b>	0.001 kg

**Protective cover, IP 65**

**Additional Information**

- Please note that bigger minimum distances are necessary
- Use only flush front bezel
- Hinged, with means for sealing
- Front panel thickness reduces by 2 mm



Dimensions [mm]

Product attribute	Material	Optics	Dimension	Part No.	Weight
 <p><b>Protective cover</b></p>					
for button with mounting cut-out 21.2 x 29.2 mm	Plastic	transparent	36 x 29.7 mm	<b>22-925</b>	0.004 kg

# 02 Accessories

## Spare key

### Additional Information

- Keylock number YB1

Part No.	Weight
 <p><b>Spare key</b></p>	
02-989.001	0.001 kg

## Front protective cap, IP 65

### Additional Information

- Use only flush front bezel
- Three-part



Dimensions [mm]



Mounting cut-outs [mm]

Material	Colour	Optics	Temperature	Part No.	Weight
 <p><b>Front protective cap</b></p>					
PVC	colourless	transparent	-20 ... +60 °	<b>02-924</b>	0.005 kg
			-25 ... +85 °	<b>02-935</b>	0.005 kg

**Blind plug**



Mounting cut-outs [mm]

Dimension	Material	Colour	Part No.	Weight
 <p><b>Blind plug</b></p>	Plastic	black	<b>02-949.0</b>	0.004 kg
		grey	<b>02-949.8</b>	0.004 kg

# 02 Accessories

## Backside

### Terminal cover

#### Additional Information

- For all connection methods
- Not suitable for indicators with built-in series resistor with lamp

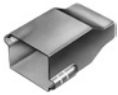
Part No.	Weight
 <b>Terminal cover</b>	
02-929	0.005 kg



**Illumination**

**Single-LED, T6.8**

**Additional Information**

- For LED element fitting information see «Application guidelines»
- Due to high surface temperatures, the series resistor must not be soldered directly to the terminals of the equipment (use a terminal plate)
- When using AC/DC types with AC operation, slight flickering can occur
- Luminous intensity data of the LEDs on direct voltage
- Electrical and optical data are measured at 25 °C
- The specified versions are built with a protection diode (half wave rectifier) in series and the LED
- Luminosity and wave length variations caused by LED manufacturing processes may cause slight differences regarding the illumination
- For supply voltages above 48 V, it is necessary to use a voltage reduction element (external series resistor or transformer)



Dimensions [mm]

LED colour	Operating voltage	Operation current	Lumi. intensity	Dom. wavelength	Part No.	Weight
 <p><b>Single-LED</b></p>						
red	6 VDC	17 mA ±15 %	400 mcd	630 nm	<b>10-2K06.3152</b>	0.002 kg
	12 VAC/DC	9/17 mA ±15 %	400 mcd	630 nm	<b>10-2K09.1072</b>	0.002 kg
	24 VAC/DC	9/17 mA ±15 %	400 mcd	630 nm	<b>10-2K12.1072</b>	0.002 kg
	28 VAC/DC	9/17 mA ±15 %	400 mcd	630 nm	<b>10-2K13.1072</b>	0.002 kg
	48 VAC/DC	4/8 mA ±15 %	200 mcd	630 nm	<b>10-2K19.1052</b>	0.002 kg
yellow	6 VDC	17 mA ±15 %	340 mcd	340 nm	<b>10-2K06.3154</b>	0.002 kg
	12 VAC/DC	9/17 mA ±15 %	340 mcd	340 nm	<b>10-2K09.1074</b>	0.002 kg
	24 VAC/DC	9/17 mA ±15 %	340 mcd	340 nm	<b>10-2K12.1074</b>	0.002 kg
	28 VAC/DC	9/17 mA ±15 %	340 mcd	340 nm	<b>10-2K13.1074</b>	0.002 kg
	48 VAC/DC	4/8 mA ±15 %	180 mcd	340 nm	<b>10-2K19.1054</b>	0.002 kg
green	6 VDC	7 mA ±15 %	1050 mcd	525 nm	<b>10-2K06.3155</b>	0.002 kg
	12 VAC/DC	4/7 mA ±15 %	1050 mcd	525 nm	<b>10-2K09.1075</b>	0.002 kg
	24 VAC/DC	4/7 mA ±15 %	1050 mcd	525 nm	<b>10-2K12.1075</b>	0.002 kg
	28 VAC/DC	4/7 mA ±15 %	1050 mcd	525 nm	<b>10-2K13.1075</b>	0.002 kg
	48 VAC/DC	2/4 mA ±15 %	600 mcd	525 nm	<b>10-2K19.1055</b>	0.002 kg
blue	6 VDC	17 mA ±15 %	780 mcd	470 nm	<b>10-2K06.3156</b>	0.002 kg
	12 VAC/DC	9/17 mA ±15 %	780 mcd	470 nm	<b>10-2K09.1076</b>	0.002 kg
	24 VAC/DC	9/17 mA ±15 %	780 mcd	470 nm	<b>10-2K12.1076</b>	0.002 kg
	28 VAC/DC	9/17 mA ±15 %	780 mcd	470 nm	<b>10-2K13.1076</b>	0.002 kg
	48 VAC/DC	4/8 mA ±15 %	400 mcd	470 nm	<b>10-2K19.1056</b>	0.002 kg

## 02 Accessories

LED colour	Operating voltage	Operation current	Lumi. intensity	Dom. wavelength	Part No.	Weight
white	6 VDC	6 mA $\pm$ 15 %	900 mcd	x0.31/y0.32 nm	<b>10-2K06.3159</b>	0.002 kg
	12 VAC/DC	3/6 mA $\pm$ 15 %	900 mcd	x0.31/y0.32 nm	<b>10-2K09.1079</b>	0.002 kg
	24 VAC/DC	3/6 mA $\pm$ 15 %	900 mcd	x0.31/y0.32 nm	<b>10-2K12.1079</b>	0.002 kg
	28 VAC/DC	2.5/5 mA $\pm$ 15 %	750 mcd	x0.31/y0.32 nm	<b>10-2K13.1079</b>	0.002 kg
	48 VAC/DC	2/4 mA $\pm$ 15 %	600 mcd	x0.31/y0.32 nm	<b>10-2K19.1059</b>	0.002 kg

### Filament lamp, T6.8

Operating voltage	Operation current	Part No.	Weight
 <p><b>Filament lamp</b></p>			
12 VAC/DC	50 mA $\pm$ 10 %	<b>10-1209.1279</b>	0.001 kg
12 VAC/DC	100 mA $\pm$ 10 %	<b>10-1209.1329</b>	0.001 kg
24 VAC/DC	25 mA $\pm$ 10 %	<b>10-1212.1199</b>	0.001 kg
24 VAC/DC	50 mA $\pm$ 10 %	<b>10-1212.1279</b>	0.001 kg
28 VAC/DC	40 mA $\pm$ 10 %	<b>10-1213.1249</b>	0.001 kg
30 VAC/DC	40 mA $\pm$ 10 %	<b>10-1214.1249</b>	0.001 kg
36 VAC/DC	35 mA $\pm$ 10 %	<b>10-1216.1229</b>	0.001 kg

### Series resistor

#### Additional Information

- For filament lamp 48 VAC, 25 mA
- For lamp voltage reduction
- Keep to the country specific safety instructions
- Due to high surface temperatures, the series resistor must not be soldered directly to the terminals of the equipment (use a terminal plate)

Operating voltage	Resistance	Part No.	Weight
 <p><b>Series resistor</b></p>			
110 VAC	2.7 kOhm	<b>02-904.0</b>	0.003 kg
125 VAC	3.3 kOhm	<b>02-904.1</b>	0.003 kg
145 VAC	4.7 kOhm	<b>02-904.3</b>	0.003 kg
240 VAC	10 kOhm	<b>02-904.7</b>	0.003 kg

**Terminal plate empty****Additional Information**

- For fitting with series resistors

Product attribute	Dimension	Part No.	Weight
 <p><b>Terminal plate empty</b></p>			
5 spaces	62.5 x 60 x 15 mm	<b>02-912.1</b>	0.025 kg
10 spaces	125 x 60 x 15 mm	<b>02-912.2</b>	0.045 kg
15 spaces	187.6 x 60 x 15 mm	<b>02-912.3</b>	0.090 kg
20 spaces	250 x 60 x 15 mm	<b>02-912.4</b>	0.095 kg

## 02 Accessories

### Mounting

#### Lens remover

Product attribute	Part No.	Weight
 <b>Lens remover</b>		
for flush front bezel	<b>02-905</b>	0.011 kg
 <b>Lens remover</b>		
for raised front bezel	<b>98-968</b>	0.004 kg

#### Lamp remover

##### Additional Information

▲ **Vorsicht:** A switching process might be released when replacing the lamp

Product attribute	Part No.	Weight
 <b>Lamp remover</b>		
for LED	<b>03-996</b>	0.027 kg
 <b>Lamp remover</b>		
for filament lamp	<b>61-9740.0</b>	0.003 kg

**Actuator with snap-action switching element**
**Switching system**

1 or 2 self-cleaning, snap-action switching elements.  
1 or 2 double-throw contacts.

**Material**
**Material of contact**

Standard version:  
Silver (U > 20V)  
Special versions: (on request)  
Gold/Silver 700Au/300Ag (U < 50V)  
Silver/Palladium 700Ag/300Pd (U > 20V) for atmospheres containing sulphur

**Switch housing**

Thermosetting material, heat-resistant

**Indicator housing with reduced length**

Polyamide

**Mechanical characteristics**
**Terminals**

Screw terminal (with self-lifting clip):  
max. wire cross-section, 2 x 2.5 mm<sup>2</sup>  
max. wire cross-section of stranded cable, 2 x 1.5 mm<sup>2</sup>

**Tightening torque**

For fixing sleeve max. 20Ncm  
For screw terminal max. 80Ncm

**Actuating force**

6N ... 12N

**Actuating travel**

5mm

**Mechanical lifetime**

Momentary action 2 million operations  
Maintained action 1 million operations

**Electrical characteristics**
**Standards**

The switches comply with the "Standards for low-voltage switching devices" IEC 60947-5-1

**Rated insulation voltage**

400VAC/440VDC, as per IEC 60947-5-1

**Conventional free air thermal current**

10A

The maximum current in continuous operation and at ambient temperature not exceeding the quoted maximum values.

**Switch rating**

400VAC, 10A, cosφ 0.95, as per IEC 60947-5-1  
250VAC, 10A, as per UL

**Electric strength**

2500VAC, 50Hz, 1 min. between all terminals and earth, as per IEC 60947-5-1

**Environmental conditions**
**Storage temperature**

-30°C ... +85°C

**Service temperature**

-25°C ... +55°C

For indicators and illuminated pushbuttons mounted as a block, make sure the heat can escape freely.

**Protection degree**

Front side IP 40, IP 65 with spray cover, as per IEC 60529

**Shock resistance**

15g for 11 ms, as per IEC 60068-2-27

**Vibration resistance**

10g at 10 ... 2000Hz, amplitude 1.0mm, as per IEC 60068-2-6

**Approvals**
**Approbations**

CB (IEC 60947-5-1)  
CSA  
Germanischer Lloyd  
UL

**Declaration of conformity**

CE

# 02 Technical data

## Buzzer

### Buzzer system

#### System

Electronic non-contacting buzzer with IC oscillator

### Material

#### Buzzer case

Thermosetting material

#### Front cap

Polycarbonate (PC)

#### Front bezel

Polymethylacrylate

### Mechanical characteristics

#### Terminals

Screw terminal

#### Tightening torque

For fixing sleeve max. 20Ncm

For screw terminal max. 80Ncm

### Electrical characteristics

#### Frequency (tone)

Approx. 2.8 kHz

#### Sound pressure

85 dB (A)  $\pm 8$  dB at a distance of 0.1 m

Volume variable with a M $\Omega$  potentiometer or corresponding fixed resistor

### Operation Voltage/Current

typical

10 ... 55 VAC 10 ... 75 VDC

25 mA 15 mA

### Environmental conditions

#### Storage temperature

-40 °C ... +85 °C

#### Operating temperature

-25 °C ... +55 °C

#### Protection degree

Front side IP 40, as per IEC 60529

### Approvals

#### Approbations

CB (IEC 60947-5-1)

#### Declaration of conformity

CE

*EAO reserves the right to alter specifications without further notice.*

## General notes

### 1. Engraving

In addition to the most commonly used world languages, in DIN1451-3 close spacing, other typefaces are available as Scandinavian, Slavic, Greek, Russian and Polish. Red, blue and black lenses are filled with white colour. Other colour lenses are filled in black. Standard height of letters is 3 mm. If the height is not specified, we will supply 3 mm engraved letters.

### 2. Hot stamping

For larger series it is worth considering markings by means of hot stamping. We will pleased to advise you. For letters and figures, typefaces with 2.5 mm, 3 mm and 4 mm are available.

### 3. Film inserts

Instead of using engraving the lenses can be fitted with transparent film inserts, as an alternative. For this purpose, though, it is advisable to use lenses without ripped pattern. In the case of use of a smoke-black lens the fitted film becomes readable only if the lamp is on. The film (F) is inserted in the cap. To ensure even illumination a diffusor (D) is recommended, which is inserted beneath the film. If, on the other hand, the diffusor is inserted above the film, the lettering only becomes legible when the lamp is alight. To hold the film and diffusor in position, the use of a holder (N) is advised. The film thickness is 0.2 mm.

All dimensions in mm

Film insert max. size	Height of letters h	Number of lines	Number of capital letters per line (target value)	Number of small letters per line (target value)	Image
14.3 x 22.4	3	4	11	13	B1
			7-8	8-9	B2
	4	2	7	9	B1
			4	5-6	B2
	5	2	5-6	6-7	B1
			3	4	B2
	6	1	5	6	B1
			3	4	B2
	8	1	3	4	B1
			2	2	B2



B1



B2



# 02 Application guidelines

## Suppressor circuits

When switching inductive loads such as relays, DC motors, and DC solenoids, it is always important to absorb surges (e.g. with a diode) to protect the contacts. When these inductive loads are switched off, a counter emf can severely damage switch contacts and greatly shorten lifetime.

Fig. 1 shows an inductive load with a free-wheeling diode connected in parallel. This free-wheeling diode provides a path for the inductor current to flow when the current is interrupted by the switch. Without this free-wheeling diode, the voltage across the coil will be limited only by dielectric breakdown voltages of the circuit or parasitic elements of the coil. This voltage can be kilovolts in amplitude even when nominal circuit voltages are low (e.g. 12VDC) see Fig. 2.

The free-wheeling diode should be chosen so that the reverse breakdown voltage is greater than the voltage driving the inductive load. The DC blocking voltage ( $V_R$ ) of the free-wheeling diode can be found in the datasheet of a diode. The forward current should be equal or greater than the maximum current flowing through the load.

**To get an efficient protection, the free-wheeling diode must be connected as close as possible to the inductive load!**

Switching with inductive load  
Fig. 1



Counter EMF  
over load without free-wheeling diode  
Fig. 2



## LED polarity

When fitting the LED element the polarity has to correspond with the respective terminal, (+) goes to +.





**Index from Part No.**

<u>Part No.</u>	<u>Page</u>	<u>Part No.</u>	<u>Page</u>
02-021.001 .....	4	10-2K06.3159.....	18
02-070.001 .....	4	10-2K09.1072.....	17
02-071.001 .....	4	10-2K09.1074.....	17
02-072.001 .....	4	10-2K09.1075.....	17
02-073.001 .....	4	10-2K09.1076.....	17
02-198.011 .....	10	10-2K09.1079.....	18
02-611.011 .....	6	10-2K12.1072.....	17
02-611.011 .....	8	10-2K12.1074.....	17
02-612.011 .....	6	10-2K12.1075.....	17
02-612.011 .....	8	10-2K12.1076.....	17
02-613.011 .....	6	10-2K12.1079.....	18
02-613.011 .....	8	10-2K13.1072.....	17
02-614.011 .....	6	10-2K13.1074.....	17
02-614.011 .....	8	10-2K13.1075.....	17
02-615.011 .....	6	10-2K13.1076.....	17
02-615.011 .....	8	10-2K13.1079.....	18
02-616.011 .....	7	10-2K19.1052.....	17
02-617.011 .....	7	10-2K19.1054.....	17
02-618.011 .....	7	10-2K19.1055.....	17
02-619.011 .....	7	10-2K19.1056.....	17
02-620.011 .....	7	10-2K19.1059.....	18
02-690.011 .....	9	22-925 .....	13
02-691.011 .....	9	61-9740.0 .....	20
02-692.011 .....	9	98-968 .....	20
02-695.011 .....	10		
02-810.001 .....	5		
02-901.0 .....	11		
02-901.1 .....	11		
02-901.2 .....	11		
02-901.3 .....	11		
02-901.4 .....	11		
02-901.5 .....	11		
02-901.6 .....	11		
02-901.7 .....	11		
02-901.8 .....	11		
02-901.9 .....	11		
02-902.2 .....	11		
02-902.5 .....	11		
02-902.7 .....	11		
02-904.0 .....	18		
02-904.1 .....	18		
02-904.3 .....	18		
02-904.7 .....	18		
02-905 .....	20		
02-908.2 .....	12		
02-908.3 .....	12		
02-908.4 .....	12		
02-908.5 .....	12		
02-908.6 .....	12		
02-908.7 .....	12		
02-908.9 .....	12		
02-909 .....	12		
02-912.1 .....	19		
02-912.2 .....	19		
02-912.3 .....	19		
02-912.4 .....	19		
02-924 .....	14		
02-929 .....	16		
02-935 .....	14		
02-949.0 .....	15		
02-949.8 .....	15		
02-965.0 .....	13		
02-967.0 .....	13		
02-980.1 .....	12		
02-989.001 .....	14		
03-996 .....	20		
10-1209.1279 .....	18		
10-1209.1329 .....	18		
10-1212.1199 .....	18		
10-1212.1279 .....	18		
10-1213.1249 .....	18		
10-1214.1249 .....	18		
10-1216.1229 .....	18		
10-2K06.3152.....	17		
10-2K06.3154.....	17		
10-2K06.3155.....	17		
10-2K06.3156.....	17		



## Данный компонент на территории Российской Федерации

### Вы можете приобрести в компании MosChip.

Для оперативного оформления запроса Вам необходимо перейти по данной ссылке:

<http://moschip.ru/get-element>

Вы можете разместить у нас заказ для любого Вашего проекта, будь то серийное производство или разработка единичного прибора.

В нашем ассортименте представлены ведущие мировые производители активных и пассивных электронных компонентов.

Нашей специализацией является поставка электронной компонентной базы двойного назначения, продукции таких производителей как XILINX, Intel (ex.ALTERA), Vicor, Microchip, Texas Instruments, Analog Devices, Mini-Circuits, Amphenol, Glenair.

Сотрудничество с глобальными дистрибьюторами электронных компонентов, предоставляет возможность заказывать и получать с международных складов практически любой перечень компонентов в оптимальные для Вас сроки.

На всех этапах разработки и производства наши партнеры могут получить квалифицированную поддержку опытных инженеров.

Система менеджмента качества компании отвечает требованиям в соответствии с ГОСТ Р ИСО 9001, ГОСТ РВ 0015-002 и ЭС РД 009

### Офис по работе с юридическими лицами:

105318, г.Москва, ул.Щербаковская д.3, офис 1107, 1118, ДЦ «Щербаковский»

Телефон: +7 495 668-12-70 (многоканальный)

Факс: +7 495 668-12-70 (доб.304)

E-mail: [info@moschip.ru](mailto:info@moschip.ru)

Skype отдела продаж:

moschip.ru

moschip.ru\_4

moschip.ru\_6

moschip.ru\_9