

HIGH FREQUENCY HIGH-SIDE AND LOW-SIDE GATE DRIVER IN V-QFN3030-8

Description

The DGD0590 is a high-frequency high-side and low-side gate driver capable of driving N-channel MOSFETs in a half-bridge configuration. The floating high-side driver is rated up to 50V and provides a 5V gate drive to the MOSFETs.

The DGD0590 logic inputs are compatible with standard TTL and CMOS levels (down to 3.3V) to interface easily with MCUs. A UVLO protects ICs and MOSFETs with loss of supply.

Fast and well-matched propagation delays allow a higher switching frequency, enabling a smaller, more compact power switching design, using smaller associated components. The DGD0590 is offered in the V-QFN3030-8 (Type TH) package and operates over an extended -40°C to +125°C temperature range.

Applications

- Wireless Power Charger
- Motor Drive
- Logic Level MOSFET Gate Driver

Features

- 50V Floating High-Side Driver
- Low V_{CC} Operating Voltage: 4.5V to 5.5V
- Drives Two N-Channel Logic Level MOSFETs in a Half-Bridge Configuration
- High-Side 1.0A Source / 1.0A Sink and Low-Side 1.0A Source / 3.0A Sink Output Current Capability
- Internal Bootstrap Diode Included
- 3.4V UVLO with 0.4V Hysteresis
- Fast Rise and Fall Times (27ns/17ns) with 3nF Load
- Propagation Delay Typical of 16ns for High-Side and 12ns for Low-Side
- Extended Temperature Range: -40°C to +125°C
- **Totally Lead-Free & Fully RoHS Compliant (Notes 1 & 2)**
- **Halogen and Antimony free. "Green" Device (Note 3)**

Mechanical Data

- Case: V-QFN3030-8 (Type TH)
- Case Material: Molded Plastic. "Green" Molding Compound
- UL Flammability Classification Rating 94V-0
- Moisture Sensitivity: Level 3 per J-STD-020
- Terminals: Finish—Matte Tin Finish; Solderable per MIL-STD-202, Method 208 Ⓔ3
- Weight: 0.017 grams (Approximate)

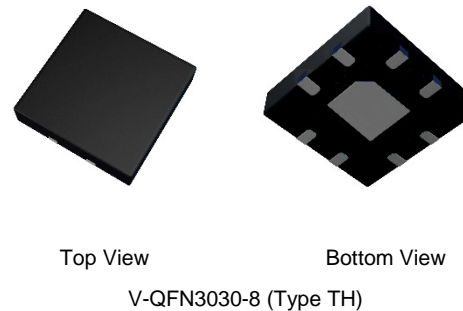
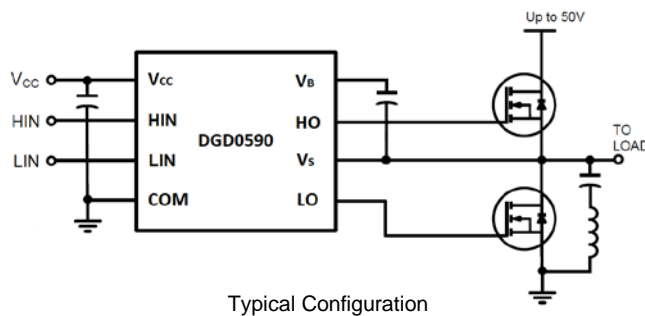

Ordering Information (Note 4)

| Product | Marking | Reel Size (inches) | Tape Width (mm) | Quantity per Reel |
|-------------|---------|--------------------|-----------------|-------------------|
| DGD0590FU-7 | DGD0590 | 7 | 8 | 3000 |

- Notes:
1. No purposely added lead. Fully EU Directive 2002/95/EC (RoHS), 2011/65/EU (RoHS 2) & 2015/863/EU (RoHS 3) compliant.
 2. See <https://www.diodes.com/quality/lead-free/> for more information about Diodes Incorporated's definitions of Halogen- and Antimony-free, "Green" and Lead-free.
 3. Halogen- and Antimony-free "Green" products are defined as those which contain <900ppm bromine, <900ppm chlorine (<1500ppm total Br + Cl) and <1000ppm antimony compounds.
 4. For packaging details, go to our website at <http://www.diodes.com/products/packages.html>.

Marking Information



DGD0590 = Product Type Marking Code
 YY = Year (ex: 18 = 2018)
 WW = Week (01 - 53)

Pin Diagrams

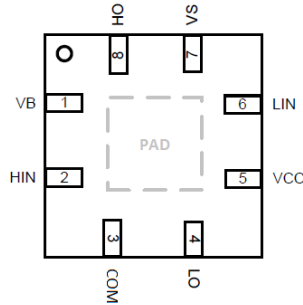

Top View: V-QFN3030-8 (Type TH)

Pin Descriptions

| Pin Number | Pin Name | Function |
|------------|-----------------|--|
| 1 | V _B | High-Side Floating Supply |
| 2 | HIN | Logic Input for High-Side Gate Driver, in Phase with HO, Pull Down Resistor at Input |
| 3 | COM | Low-Side and Logic Return |
| 4 | LO | Low-Side Gate Driver Output |
| 5 | V _{CC} | Low-Side and Logic Supply |
| 6 | LIN | Logic Input for Low-Side Gate Driver, in Phase with LO, Pull Down Resistor at Input |
| 7 | V _S | High-Side Floating Supply Return |
| 8 | HO | High-Side Gate Driver Output |
| PAD | Substrate | Connect to COM on PCB |

Functional Block Diagram

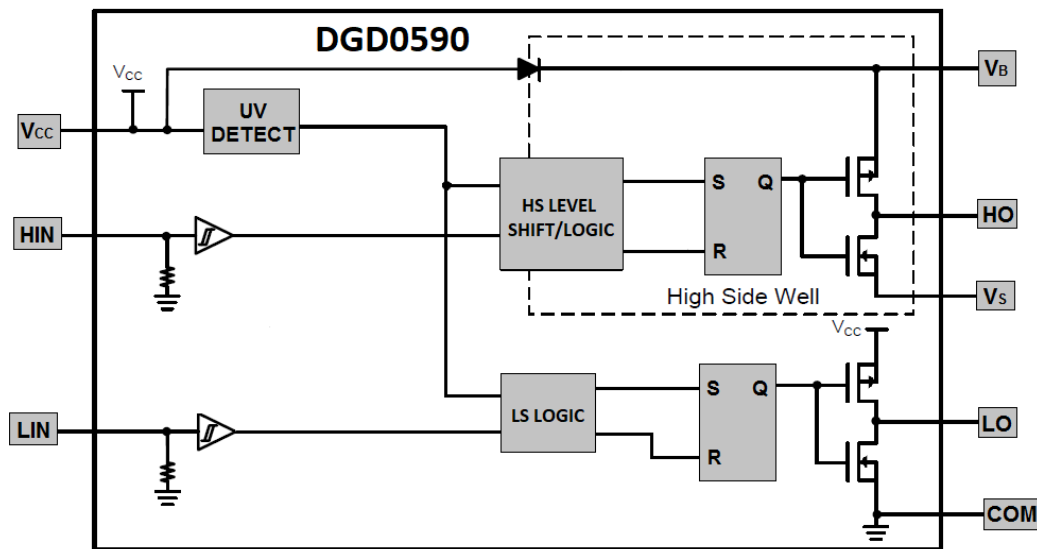

Absolute Maximum Ratings (@T_A = +25°C, unless otherwise specified.)

| Characteristic | Symbol | Value | Unit |
|--|----------------------|--|------|
| High-Side Floating Positive Supply Voltage | V _B | 0.3 to +60 | V |
| High-Side Floating Negative Supply Voltage | V _S | V _B -6 to V _B +0.3 | V |
| High-Side Floating Output Voltage | V _{HO} | V _S -0.3 to V _B +0.3 | V |
| Offset Supply Voltage Transient | dV _S / dt | 50 | V/ns |
| Logic and Low-Side Fixed Supply Voltage | V _{CC} | -0.3 to +6 | V |
| Low-Side Output Voltage | V _{LO} | -0.3 to V _{CC} +0.3 | V |
| Logic Input Voltage (HIN and LIN) | V _{IN} | -0.3 to +6 | V |

Thermal Characteristics (@T_A = +25°C, unless otherwise specified.)

| Characteristic | Symbol | Value | Unit |
|--|------------------|-------------|------|
| Thermal Resistance, Junction to Ambient (Note 5) | R _{θJA} | 120 | °C/W |
| Thermal Resistance, Junction to Case (Note 5) | R _{θJC} | 132 | °C/W |
| Operating Temperature | T _J | +150 | °C |
| Lead Temperature (Soldering, 10s) | T _L | +300 | |
| Storage Temperature Range | T _{STG} | -55 to +150 | |

Note: 5. When mounted on a standard JEDEC 2-layer FR-4 board.

Recommended Operating Conditions

| Parameter | Symbol | Min | Max | Unit |
|--|-----------------|----------------------|----------------------|------|
| High-Side Floating Supply | V _B | V _S + 4.5 | V _S + 5.5 | V |
| High-Side Floating Supply Offset Voltage | V _S | 0 | 50 (Note 6) | V |
| High-Side Floating Output Voltage | V _{HO} | V _S | V _B | V |
| Logic and Low Side Fixed Supply Voltage | V _{CC} | 4.5 | 5.5 | V |
| Low-Side Output Voltage | V _{LO} | 0 | V _{CC} | V |
| Logic Input Voltage (HIN and LIN) | V _{IN} | 0 | 5 | V |
| Ambient Temperature | T _A | -40 | +125 | °C |

Note: 6. Provided V_B doesn't exceed absolute maximum rating of 60V.

DC Electrical Characteristics ($V_{CC} = 5V$, $@T_A = +25^{\circ}C$, unless otherwise specified.)

| Parameter | Symbol | Min | Typ | Max | Unit | Conditions |
|---|-----------------|------|-----|------|----------|--|
| Logic "1" Input Voltage, HIN | V_{HIH} | — | 3.5 | 3.8 | V | — |
| Logic "0" Input Voltage, HIN | V_{HIL} | 1.0 | 1.3 | — | V | — |
| Logic "1" Input Voltage, LIN | V_{LIH} | — | 2.8 | 3.3 | V | — |
| Logic "0" Input Voltage, LIN | V_{LIL} | 1.0 | 1.2 | — | V | — |
| Logic Input Bias Current | I_{IN+} | — | 31 | 60 | μA | $V_{IN} = V_{CC}$ |
| V_{CC} Quiescent Supply Current | I_{CCQ} | — | 22 | 50 | μA | — |
| V_{CC} Operating Supply Current | I_{CCO} | — | 300 | — | μA | HO and LO Open, $f_s = 250kHz$ |
| High-Side Source Impedence | R_{HSO} | — | 1.8 | 2.6 | Ω | Source = 100mA |
| High-Side Sink Impedence | R_{HSI} | — | 1.5 | 2.1 | Ω | Sink = 100mA |
| Low-Side Source Impedence | R_{LSO} | — | 1.8 | 2.6 | Ω | Source = 100mA |
| Low-Side Sink Impedence | R_{LSI} | — | 0.4 | 1.0 | Ω | Sink = 100mA |
| V_{CC} Supply Undervoltage Positive Going Threshold | V_{CCUV+} | 2.85 | 3.4 | 3.85 | V | — |
| V_{CC} Supply Undervoltage Hysterisis | V_{CCU_HYST} | — | 0.4 | — | V | — |
| Bootstrap Diode Forward Voltage | V_{BFD} | — | 650 | 800 | mV | $I = 100\mu A$ |
| Bootstrap Diode Reverse Leakage | I_{BDL} | — | 0.1 | 0.4 | μA | $V_B = V_S = 55.5V$, $V_{CC} = 0V$ |

AC Electrical Characteristics ($V_{CC} = 5V$, $C_L = 3nF$, $@T_A = +25^{\circ}C$, unless otherwise specified.)

| Parameter | Symbol | Min | Typ | Max | Unit | Conditions |
|---------------------------------------|------------|-----|-----|-----|------|------------|
| Turn-on Rise Time | t_r | — | 27 | — | ns | — |
| Turn-off Fall Time, High-Side | t_f | — | 29 | — | ns | — |
| Turn-off Fall Time, Low-Side | | — | 17 | — | ns | — |
| Turn-on Propagation Delay, High-Side | t_{ONH} | — | 16 | — | ns | — |
| Turn-off Propagation Delay, High-Side | t_{OFFH} | — | 17 | — | ns | — |
| Turn-on Propagation Delay, Low-Side | t_{ONL} | — | 12 | — | ns | — |
| Turn-off Propagation Delay, Low-Side | t_{OFFL} | — | 17 | — | ns | — |

Timing Waveforms

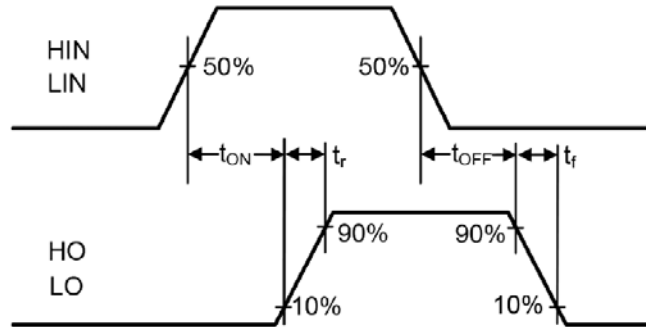

Figure 1. Switching Time Waveform Definitions

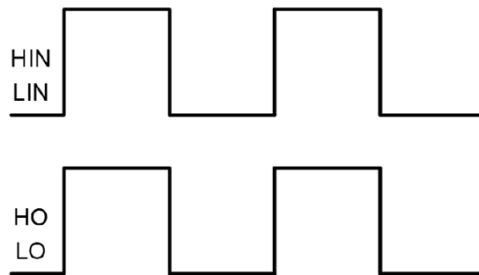

Figure 2. Input / Output Timing Diagram

Typical Performance Characteristics (@ $T_A = +25^\circ\text{C}$, unless otherwise specified.)

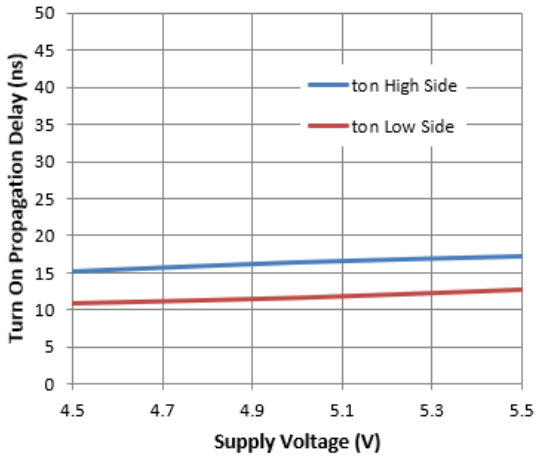

Figure 3. Turn-on Propagation Delay vs. Supply Voltage

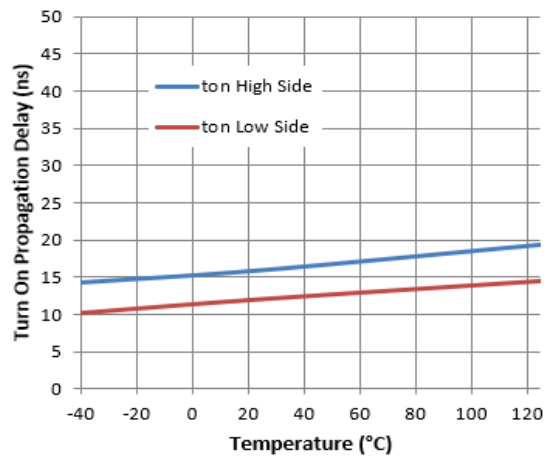

Figure 4. Turn-on Propagation Delay vs. Temperature

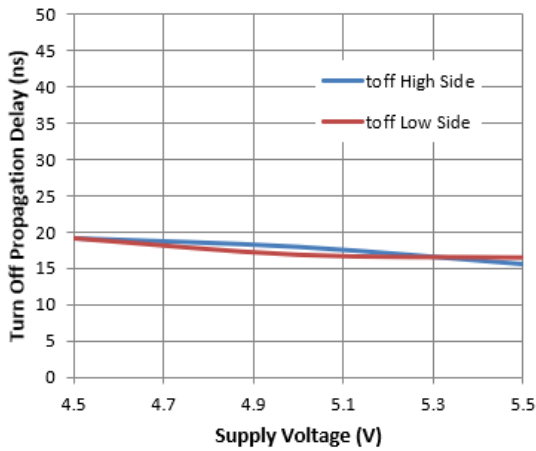

Figure 5. Turn-off Propagation Delay vs. Supply Voltage

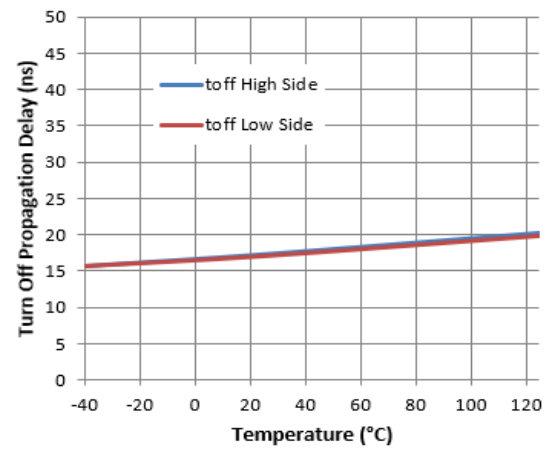

Figure 6. Turn-off Propagation Delay vs. Temperature

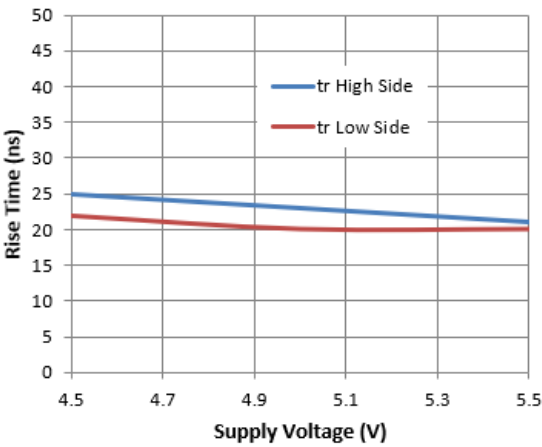

Figure 7. Rise Time vs. Supply Voltage

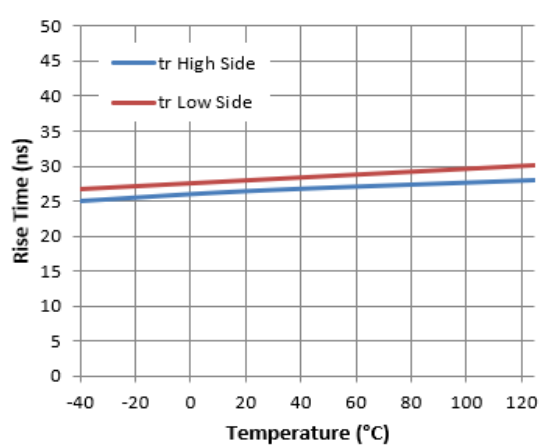

Figure 8. Rise Time vs. Temperature

Typical Performance Characteristics (continued)

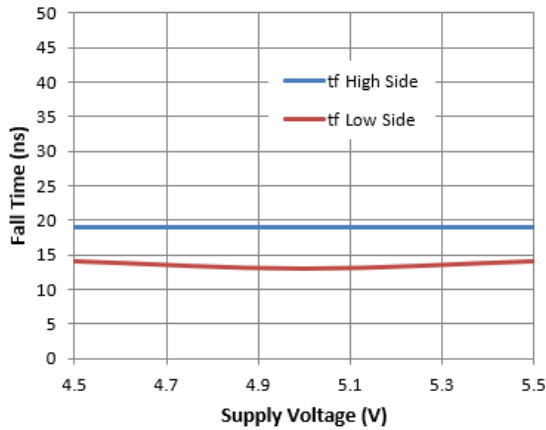

Figure 9. Fall Time vs. Supply Voltage

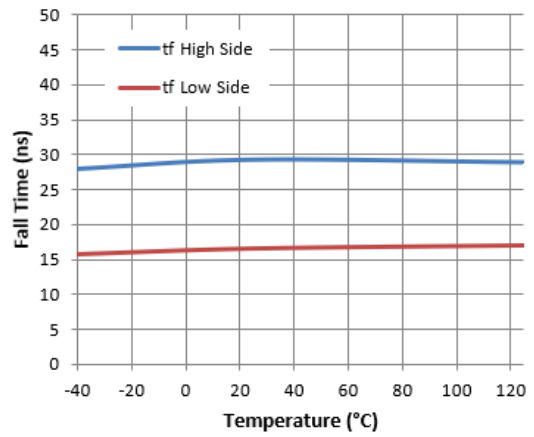

Figure 10. Fall Time vs. Temperature

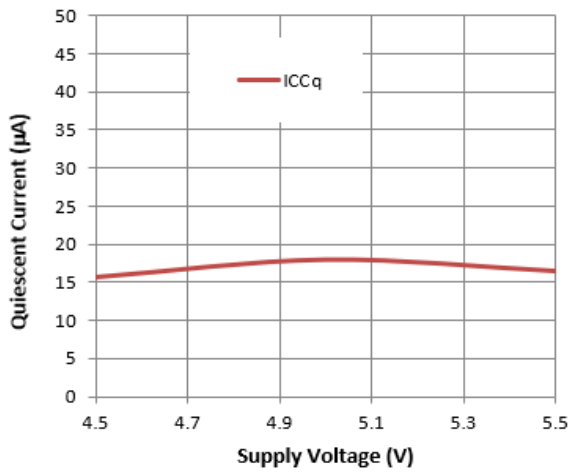

Figure 11. Quiescent Current vs. Supply Voltage

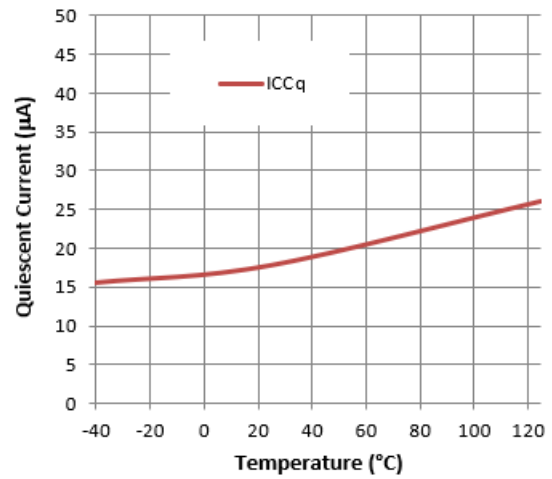

Figure 12. Quiescent Current vs. Temperature

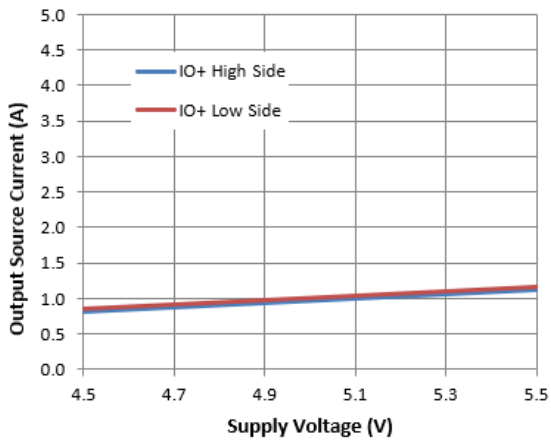

Figure 13. Output Source Current vs. Supply Voltage

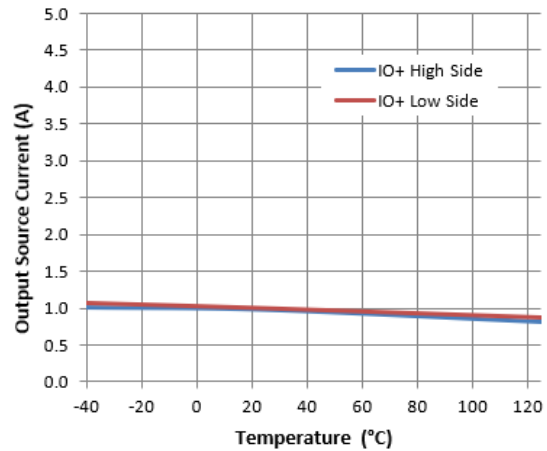

Figure 14. Output Source Current vs. Temperature

Typical Performance Characteristics (cont.)

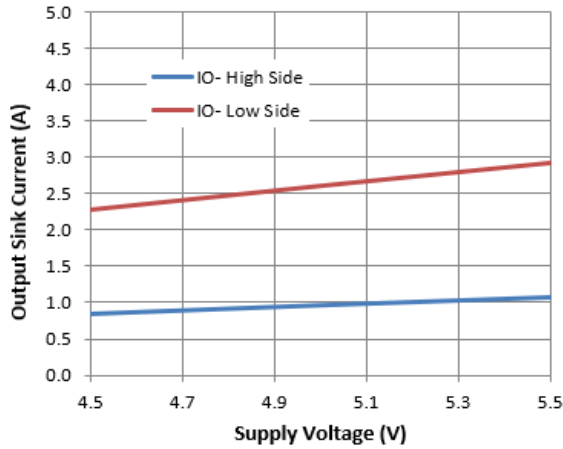

Figure 15. Output Sink Current vs. Supply Voltage

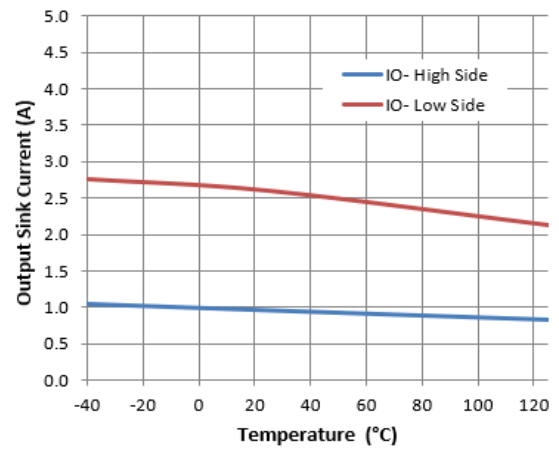

Figure 16. Output Sink Current vs. Temperature

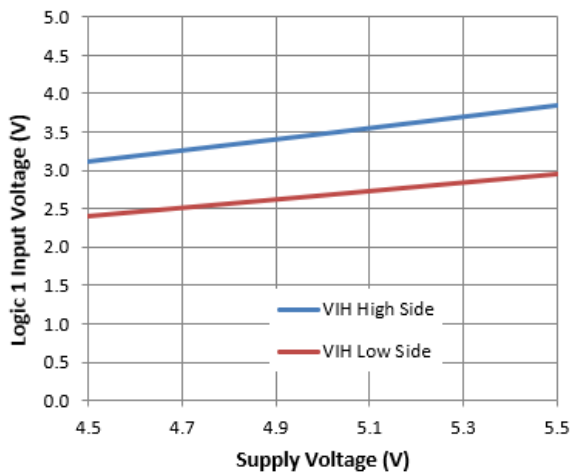

Figure 17. Logic 1 Input Voltage vs. Supply Voltage

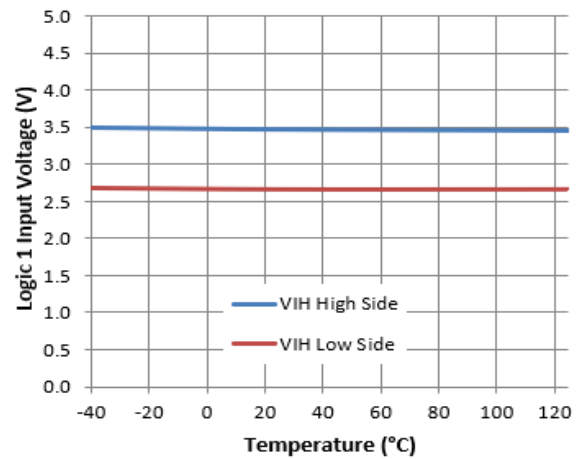

Figure 18. Logic 1 Input Voltage vs. Temperature

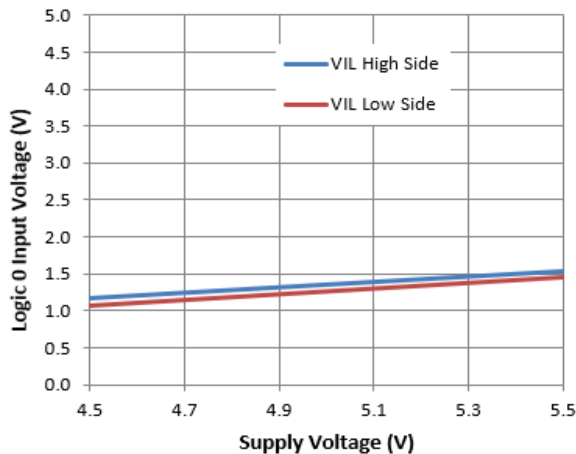

Figure 19. Logic 0 Input Voltage vs. Supply Voltage

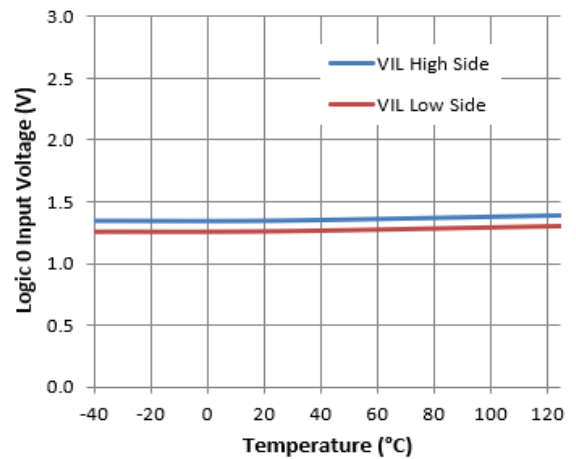

Figure 20. Logic 0 Input Voltage vs. Temperature

Typical Performance Characteristics (cont.)

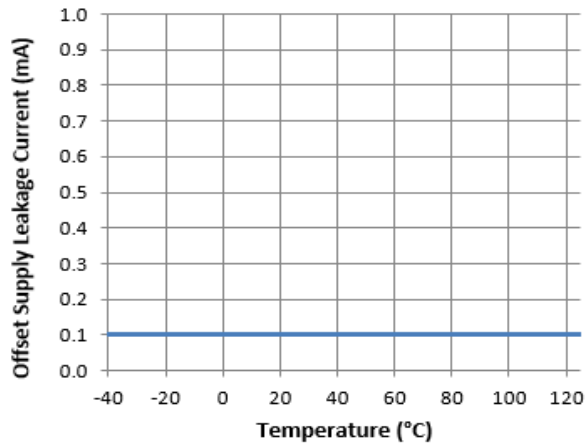
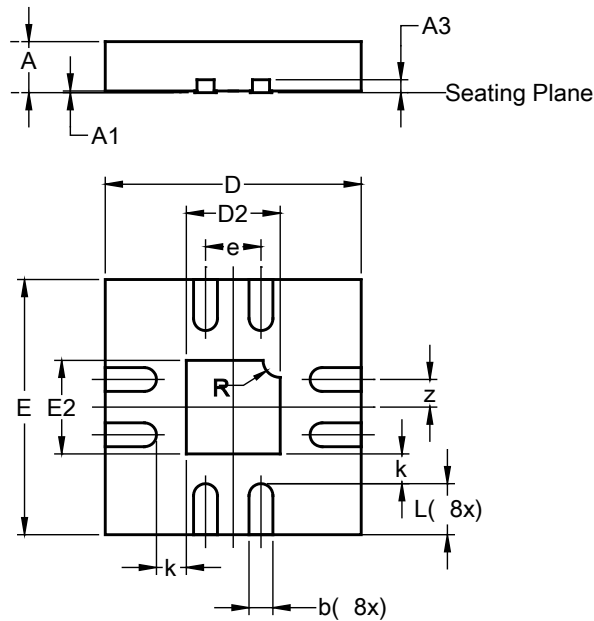

Figure 21. Offset Supply Leakage Current vs. Temperature

Package Outline Dimensions

Please see <http://www.diodes.com/package-outlines.html> for the latest version.

V-QFN3030-8 (Type TH)



| V-QFN3030-8 (Type TH) | | | |
|--------------------------|-------|-------|-------|
| Dim | Min | Max | Typ |
| A | 0.80 | 1.00 | 0.90 |
| A1 | 0.00 | 0.05 | 0.02 |
| A3 | — | — | 0.20 |
| b | 0.275 | 0.285 | 0.280 |
| D | — | — | 3.00 |
| D2 | 0.95 | 1.25 | 1.10 |
| E | — | — | 3.00 |
| E2 | 0.95 | 1.25 | 1.10 |
| e | — | — | 0.65 |
| L | 0.50 | 0.70 | 0.60 |
| k | — | — | 0.35 |
| z | — | — | 0.325 |
| R | — | — | 0.20 |
| All Dimensions in mm | | | |

Suggested Pad Layout

Please see <http://www.diodes.com/package-outlines.html> for the latest version.

V-QFN3030-8 (Type TH)

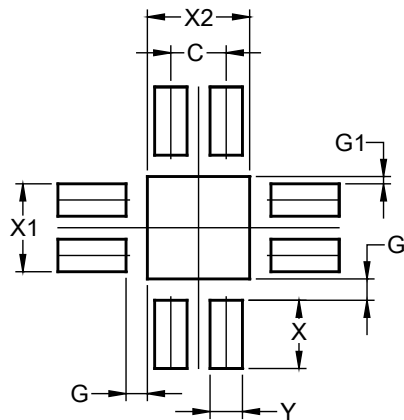

| Dimensions | Value (in mm) |
|------------|------------------|
| C | 0.650 |
| G | 0.250 |
| G1 | 0.085 |
| X | 0.800 |
| X1 | 1.030 |
| X2 | 1.200 |
| Y | 0.380 |

IMPORTANT NOTICE

DIODES INCORPORATED MAKES NO WARRANTY OF ANY KIND, EXPRESS OR IMPLIED, WITH REGARDS TO THIS DOCUMENT, INCLUDING, BUT NOT LIMITED TO, THE IMPLIED WARRANTIES OF MERCHANTABILITY AND FITNESS FOR A PARTICULAR PURPOSE (AND THEIR EQUIVALENTS UNDER THE LAWS OF ANY JURISDICTION).

Diodes Incorporated and its subsidiaries reserve the right to make modifications, enhancements, improvements, corrections or other changes without further notice to this document and any product described herein. Diodes Incorporated does not assume any liability arising out of the application or use of this document or any product described herein; neither does Diodes Incorporated convey any license under its patent or trademark rights, nor the rights of others. Any Customer or user of this document or products described herein in such applications shall assume all risks of such use and will agree to hold Diodes Incorporated and all the companies whose products are represented on Diodes Incorporated website, harmless against all damages.

Diodes Incorporated does not warrant or accept any liability whatsoever in respect of any products purchased through unauthorized sales channel. Should Customers purchase or use Diodes Incorporated products for any unintended or unauthorized application, Customers shall indemnify and hold Diodes Incorporated and its representatives harmless against all claims, damages, expenses, and attorney fees arising out of, directly or indirectly, any claim of personal injury or death associated with such unintended or unauthorized application.

Products described herein may be covered by one or more United States, international or foreign patents pending. Product names and markings noted herein may also be covered by one or more United States, international or foreign trademarks.

This document is written in English but may be translated into multiple languages for reference. Only the English version of this document is the final and determinative format released by Diodes Incorporated.

LIFE SUPPORT

Diodes Incorporated products are specifically not authorized for use as critical components in life support devices or systems without the express written approval of the Chief Executive Officer of Diodes Incorporated. As used herein:

A. Life support devices or systems are devices or systems which:

1. are intended to implant into the body, or
2. support or sustain life and whose failure to perform when properly used in accordance with instructions for use provided in the labeling can be reasonably expected to result in significant injury to the user.

B. A critical component is any component in a life support device or system whose failure to perform can be reasonably expected to cause the failure of the life support device or to affect its safety or effectiveness.

Customers represent that they have all necessary expertise in the safety and regulatory ramifications of their life support devices or systems, and acknowledge and agree that they are solely responsible for all legal, regulatory and safety-related requirements concerning their products and any use of Diodes Incorporated products in such safety-critical, life support devices or systems, notwithstanding any devices- or systems-related information or support that may be provided by Diodes Incorporated. Further, Customers must fully indemnify Diodes Incorporated and its representatives against any damages arising out of the use of Diodes Incorporated products in such safety-critical, life support devices or systems.

Copyright © 2018, Diodes Incorporated

www.diodes.com

Данный компонент на территории Российской Федерации

Вы можете приобрести в компании MosChip.

Для оперативного оформления запроса Вам необходимо перейти по данной ссылке:

<http://moschip.ru/get-element>

Вы можете разместить у нас заказ для любого Вашего проекта, будь то серийное производство или разработка единичного прибора.

В нашем ассортименте представлены ведущие мировые производители активных и пассивных электронных компонентов.

Нашей специализацией является поставка электронной компонентной базы двойного назначения, продукции таких производителей как XILINX, Intel (ex.ALTERA), Vicor, Microchip, Texas Instruments, Analog Devices, Mini-Circuits, Amphenol, Glenair.

Сотрудничество с глобальными дистрибьюторами электронных компонентов, предоставляет возможность заказывать и получать с международных складов практически любой перечень компонентов в оптимальные для Вас сроки.

На всех этапах разработки и производства наши партнеры могут получить квалифицированную поддержку опытных инженеров.

Система менеджмента качества компании отвечает требованиям в соответствии с ГОСТ Р ИСО 9001, ГОСТ РВ 0015-002 и ЭС РД 009

Офис по работе с юридическими лицами:

105318, г.Москва, ул.Щербаковская д.3, офис 1107, 1118, ДЦ «Щербаковский»

Телефон: +7 495 668-12-70 (многоканальный)

Факс: +7 495 668-12-70 (доб.304)

E-mail: info@moschip.ru

Skype отдела продаж:

moschip.ru

moschip.ru_4

moschip.ru_6

moschip.ru_9