

XW2R Series Connector-Terminal Block Conversion Units

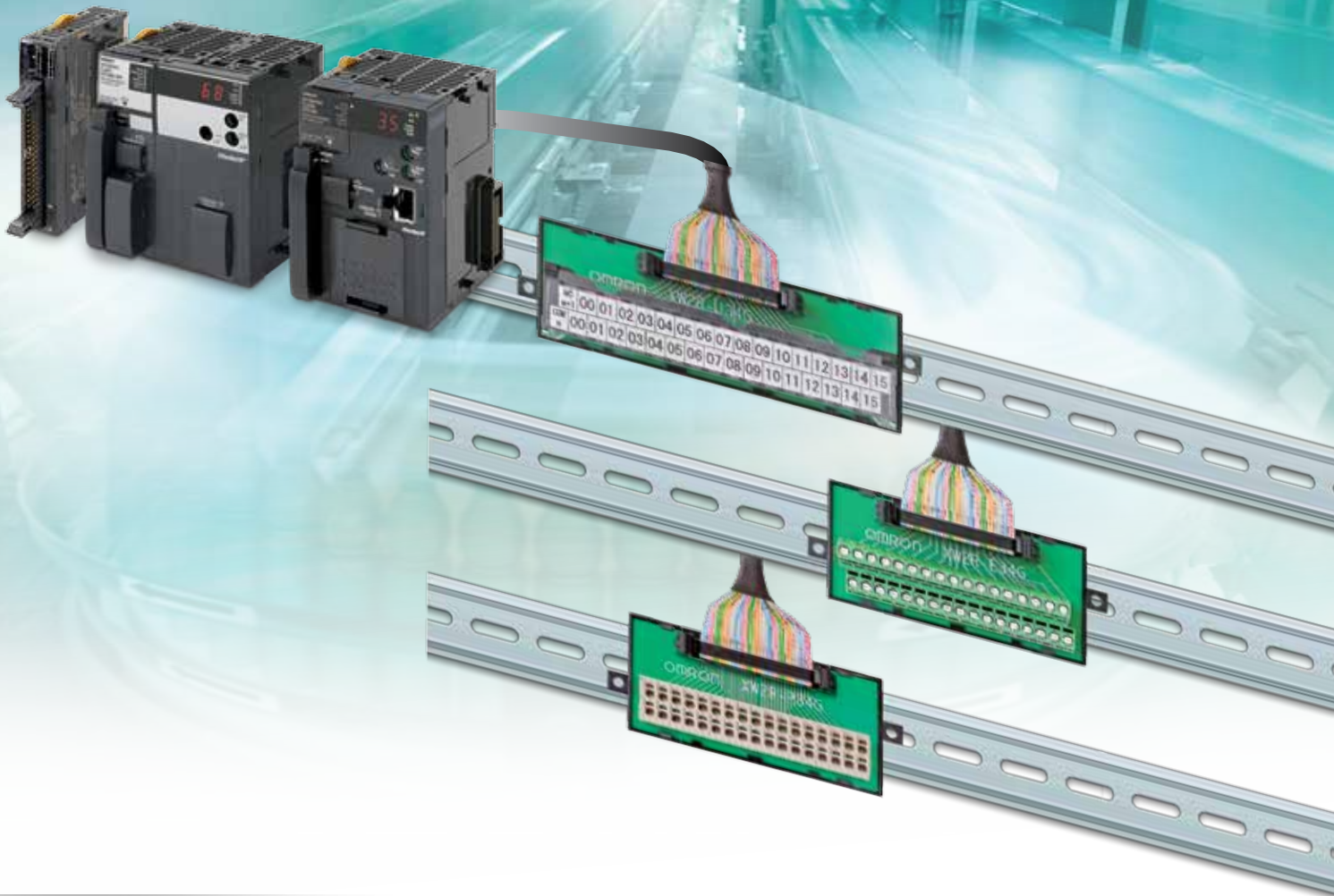

» Simple connection to controllers

» **Slim design**

» Variety of models for various controller types

- Specialized wiring pattern for OMRON and Mitsubishi PLCs
- Minimized size with required number of poles
- Wide variation of poles

General-purpose devices

Wide variation of poles

M3 Screw

XW2R-J□□□□-T□



Clamp

XW2R-E□□□□-T□

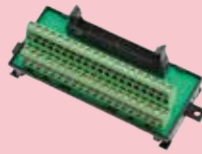

Spring Clamp

XW2R-P□□□□-T□



To page 13 for details on models for general-purpose devices

To page 4 for details on models for OMRON PLCs

To page 9 for details on models for Mitsubishi PLCs

All Models

- Spring Clamp terminals simplify wiring and make the terminal blocks even easier to use. (In comparison to the OMRON XW2F.)
- The terminal arrangement enables smoother wiring work.
- Mount to DIN Rail or with screws.
- Common design that can also be customized.

Connecting Spring Clamp Terminals

Using Ferrules

- How to insert wire

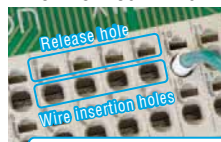

Insert wire into the terminal block.

- How to release wire



Insert the screwdriver into the release hole and pull out the ferrule.

Using Stripped Wires



- Inserting and Removing Wires



To insert a wire, insert a screwdriver into the release hole and then insert the stripped wire. To remove a wire, insert a screwdriver into the release hole and then pull out the stripped wire.

New Series XW2R

Product Lineup

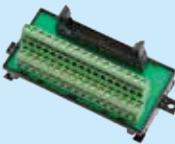
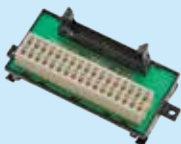
| | | | | |
|----------------------|--------------------|---|--|---|
| Type | |  PLCs  | | |
| Features | | Specialized wiring pattern for PLC | Minimized size with required number of poles | |
| Terminal Type | | M3 Screw | Clamp | Spring Clamp |
| Model | For OMRON PLC | XW2R-J34G-C□ | XW2R-E34G-C□ | XW2R-P34G-C□ |
| | For Mitsubishi PLC | XW2R-J34G-M□ | XW2R-E34G-M□ | XW2R-P34G-M□ |
| Appearance | |  |  |  |

Smart Features

PLC Connecting type

- Wiring patterns that are specifically designed for PLCs reduce the work required to check signal layout.
- Terminal block signal labels give the PLC addresses.

| | | | | | | | | | | | | | | | | | | | | | | | | | | | | | | | | | | | | | | | | | | | | | | | | | | | | | | | | | | | | | | | | | |
|--------------------------|--|-----|----|----|----|----|----|----|-----|-----|-----|-----|-----|-----|-----|-----|----|----|----|----|----|----|----|----|----|-----|-----|-----|-----|-----|-----|---|-----|---|---|---|---|---|---|---|---|---|---|---|---|---|---|---|---|---|---|---|---|---|---|---|---|---|---|---|---|---|---|---|----|
| General-purpose devices | <table border="1"> <tr><td>B1</td><td>B2</td><td>B3</td><td>B4</td><td>B5</td><td>B6</td><td>B7</td><td>B8</td><td>B9</td><td>B10</td><td>B11</td><td>B12</td><td>B13</td><td>B14</td><td>B15</td></tr> <tr><td>A1</td><td>A2</td><td>A3</td><td>A4</td><td>A5</td><td>A6</td><td>A7</td><td>A8</td><td>A9</td><td>A10</td><td>A11</td><td>A12</td><td>A13</td><td>A14</td><td>A15</td></tr> </table> | B1 | B2 | B3 | B4 | B5 | B6 | B7 | B8 | B9 | B10 | B11 | B12 | B13 | B14 | B15 | A1 | A2 | A3 | A4 | A5 | A6 | A7 | A8 | A9 | A10 | A11 | A12 | A13 | A14 | A15 | | | | | | | | | | | | | | | | | | | | | | | | | | | | | | | | | | |
| B1 | B2 | B3 | B4 | B5 | B6 | B7 | B8 | B9 | B10 | B11 | B12 | B13 | B14 | B15 | | | | | | | | | | | | | | | | | | | | | | | | | | | | | | | | | | | | | | | | | | | | | | | | | | | |
| A1 | A2 | A3 | A4 | A5 | A6 | A7 | A8 | A9 | A10 | A11 | A12 | A13 | A14 | A15 | | | | | | | | | | | | | | | | | | | | | | | | | | | | | | | | | | | | | | | | | | | | | | | | | | | |
| For PLCs from OMRON | <table border="1"> <tr><td>INC</td><td>0</td><td>0</td><td>1</td><td>0</td><td>2</td><td>0</td><td>3</td><td>0</td><td>4</td><td>0</td><td>5</td><td>0</td><td>6</td><td>0</td><td>7</td><td>0</td><td>8</td><td>0</td><td>9</td><td>1</td><td>0</td><td>1</td><td>1</td><td>2</td><td>1</td><td>3</td><td>1</td><td>4</td><td>1</td><td>5</td></tr> <tr><td>COM</td><td>0</td><td>0</td><td>1</td><td>0</td><td>2</td><td>0</td><td>3</td><td>0</td><td>4</td><td>0</td><td>5</td><td>0</td><td>6</td><td>0</td><td>7</td><td>0</td><td>8</td><td>0</td><td>9</td><td>1</td><td>0</td><td>1</td><td>1</td><td>2</td><td>1</td><td>3</td><td>1</td><td>4</td><td>1</td><td>5</td></tr> </table> | INC | 0 | 0 | 1 | 0 | 2 | 0 | 3 | 0 | 4 | 0 | 5 | 0 | 6 | 0 | 7 | 0 | 8 | 0 | 9 | 1 | 0 | 1 | 1 | 2 | 1 | 3 | 1 | 4 | 1 | 5 | COM | 0 | 0 | 1 | 0 | 2 | 0 | 3 | 0 | 4 | 0 | 5 | 0 | 6 | 0 | 7 | 0 | 8 | 0 | 9 | 1 | 0 | 1 | 1 | 2 | 1 | 3 | 1 | 4 | 1 | 5 | | |
| INC | 0 | 0 | 1 | 0 | 2 | 0 | 3 | 0 | 4 | 0 | 5 | 0 | 6 | 0 | 7 | 0 | 8 | 0 | 9 | 1 | 0 | 1 | 1 | 2 | 1 | 3 | 1 | 4 | 1 | 5 | | | | | | | | | | | | | | | | | | | | | | | | | | | | | | | | | | | |
| COM | 0 | 0 | 1 | 0 | 2 | 0 | 3 | 0 | 4 | 0 | 5 | 0 | 6 | 0 | 7 | 0 | 8 | 0 | 9 | 1 | 0 | 1 | 1 | 2 | 1 | 3 | 1 | 4 | 1 | 5 | | | | | | | | | | | | | | | | | | | | | | | | | | | | | | | | | | | |
| For PLCs from Mitsubishi | <table border="1"> <tr><td>1</td><td>0</td><td>1</td><td>1</td><td>2</td><td>1</td><td>3</td><td>1</td><td>4</td><td>1</td><td>5</td><td>1</td><td>6</td><td>1</td><td>7</td><td>1</td><td>8</td><td>1</td><td>9</td><td>1</td><td>A</td><td>1</td><td>B</td><td>1</td><td>C</td><td>1</td><td>D</td><td>1</td><td>E</td><td>1</td><td>F</td><td>COM</td></tr> <tr><td>0</td><td>0</td><td>1</td><td>0</td><td>2</td><td>0</td><td>3</td><td>0</td><td>4</td><td>0</td><td>5</td><td>0</td><td>6</td><td>0</td><td>7</td><td>0</td><td>8</td><td>0</td><td>9</td><td>0</td><td>A</td><td>0</td><td>B</td><td>0</td><td>C</td><td>0</td><td>D</td><td>0</td><td>E</td><td>0</td><td>F</td><td>NC</td></tr> </table> | 1 | 0 | 1 | 1 | 2 | 1 | 3 | 1 | 4 | 1 | 5 | 1 | 6 | 1 | 7 | 1 | 8 | 1 | 9 | 1 | A | 1 | B | 1 | C | 1 | D | 1 | E | 1 | F | COM | 0 | 0 | 1 | 0 | 2 | 0 | 3 | 0 | 4 | 0 | 5 | 0 | 6 | 0 | 7 | 0 | 8 | 0 | 9 | 0 | A | 0 | B | 0 | C | 0 | D | 0 | E | 0 | F | NC |
| 1 | 0 | 1 | 1 | 2 | 1 | 3 | 1 | 4 | 1 | 5 | 1 | 6 | 1 | 7 | 1 | 8 | 1 | 9 | 1 | A | 1 | B | 1 | C | 1 | D | 1 | E | 1 | F | COM | | | | | | | | | | | | | | | | | | | | | | | | | | | | | | | | | | |
| 0 | 0 | 1 | 0 | 2 | 0 | 3 | 0 | 4 | 0 | 5 | 0 | 6 | 0 | 7 | 0 | 8 | 0 | 9 | 0 | A | 0 | B | 0 | C | 0 | D | 0 | E | 0 | F | NC | | | | | | | | | | | | | | | | | | | | | | | | | | | | | | | | | | |

General-purpose devices

- More model variations are scheduled for future development, such as models with FCN, MR, or MDR connectors in addition to the current models with MIL connectors.

Connection Examples

■ 32-point Input Unit or Output Unit

CJ1W-ID231 32-point

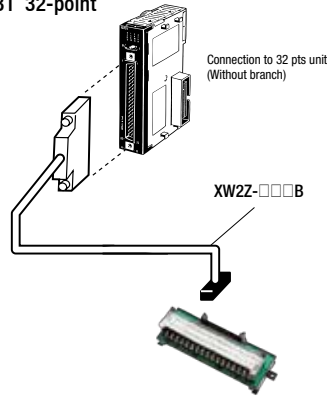

■ 64-point Input Unit or Output Unit

CJ1W-ID261 64-point

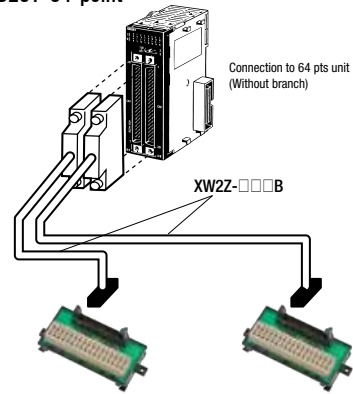

■ 64-point Output Unit

CJ1W-MD563 IN 32 Points, OUT 32 Points

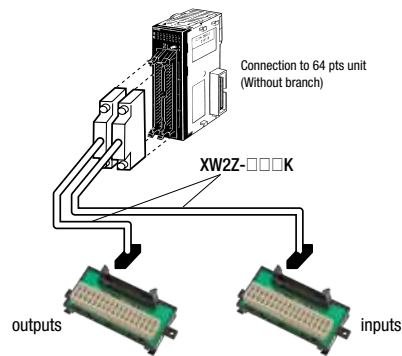

Model List

XW2R - □ 34G - □ □

| Wiring method | |
|---------------|--------------|
| J | M3 Screw |
| E | Clamp |
| P | Spring Clamp |

| Mounted Connector type | |
|------------------------|------------|
| G | MIL (XG4A) |

| PLC type | |
|----------|---|
| C1 | Refer to the following table for details. |
| C2 | |
| C3 | |
| C4 | |

Models for OMRON PLCs

| PLC Type | I/O | I/O Points | I/O Unit Model | Connecting cables | | |
|----------------------|----------------------|----------------------|----------------------|--|------------|------------|
| C1 | Input | 32 | CJ1W-ID231 | XW2Z-□□□B 32-point Unit: 1 Cable 64-point Unit: 2 Cables | | |
| | | | CS1W-ID231 | | | |
| | | | C200H-ID216 | | | |
| | | | C200H-ID218 | | | |
| | | | CQM1-ID112 | | | |
| | | | CQM1-ID213 | | | |
| | | | CQM1-ID214 | | | |
| | | | CJ1W-ID261 | | | |
| | CS1W-ID261 | 64 | C200H-ID217 | | | |
| | C200H-ID219 | | | | | |
| C200H-ID111 | 64 | C500-ID114 | | | | |
| C500-ID219 | | | | | | |
| I/O | 32 | CJ1W-MD261 (inputs) | | | | |
| | | CS1W-MD261 (inputs) | | | | |
| | | CS1W-MD262 (inputs) | | | | |
| | | CS1W-MD561 (inputs) | | | | |
| C2 | Input | 32 | CJ1W-ID232 | XW2Z-□□□K 32-point Unit: 1 Cable 64-point Unit: 2 Cables | | |
| | | 64 | CJ1W-ID233 | | | |
| | I/O | 32 | CJ1W-ID262 | | | |
| | | | CJ1W-MD263 (inputs) | | | |
| C3 | Output | 32 | CJ1W-OD231 | XW2Z-□□□B 32-point Unit: 1 Cable 64-point Unit: 2 Cables | | |
| | | | CS1W-OD231 | | | |
| | | | CS1W-OD232 | | | |
| | | | C200H-OD218 | | | |
| | | | CQM1-OD213 | | | |
| | | | CJ1W-OD261 | | 64 | CS1W-OD261 |
| | | | CS1W-OD262 | | | |
| | | | C200H-OD219 | | | |
| | C500-OD213 | | | | | |
| | CJ1W-MD261 (outputs) | 32 | CS1W-MD261 (outputs) | | | |
| | CS1W-MD262 (outputs) | | | | | |
| | CS1W-MD561 (outputs) | | | | | |
| | CJ1W-OD232 | | 32 | | CJ1W-OD233 | |
| | CJ1W-OD234 | | | | | |
| CJ1W-OD262 | 64 | CJ1W-OD263 | | | | |
| CJ1W-OD263 (outputs) | | | | | | |
| I/O | 32 | CJ1W-MD263 (outputs) | | | | |
| | | CJ1W-MD563 (outputs) | | | | |
| C4 | Output | 32 | CJ1W-OD232 | XW2Z-□□□K 32-point Unit: 1 Cable 64-point Unit: 2 Cables | | |
| | | | CJ1W-OD233 | | | |
| | | | CJ1W-OD234 | | | |
| | | | CJ1W-OD262 | | | |
| | I/O | 32 | CJ1W-MD263 (outputs) | | | |
| | | | CJ1W-MD563 (outputs) | | | |

*Connection is not possible to all OMRON PLC Units.

*□□□ is replaced by the cable length.

*There is one common for each 32 points.

*Refer to page 16-17 for information on Connecting Cables.

Models for Connection to OMRON PLCs

Clamp

| Appearance | I/O Points (number of poles) | Model | Dimension A(mm) | Dimension B(mm) |
|---|------------------------------|--------------|-----------------|-----------------|
|  | 32 (34) | XW2R-E34G-C1 | 98.5 | 108 |
| | 32 (34) | XW2R-E34G-C2 | 98.5 | 108 |
| | 32 (34) | XW2R-E34G-C3 | 98.5 | 108 |
| | 32 (34) | XW2R-E34G-C4 | 98.5 | 108 |

Ratings and Specifications

| | |
|-------------------------------|---|
| Rated current | 0.5A/signal, 4A/common |
| Rated voltage | 24VDC |
| Insulation resistance | 100MΩ min.(at 500VDC) |
| Dielectric strength | 500VAC for 1 min (leakage current: 1 mA max.) |
| Ambient operating temperature | 0 to 55°C |
| Applicable wires | Applicable wire sizes |
| | AWG 22 to 16 (rod terminals) AWG 26 to 16 (twisted or solid wires) |
| | Stripped length |
| | 7 mm |

Details on Crimp Terminals

| Applicable crimp terminals | | Applicable wires |
|----------------------------|--------------------------------------|---|
| Rod | TC-05 Dia. = 1 | AWG22 to AWG18 (0.30 to 0.75 mm ²) |
| | TC-1.25S Dia. = 1.5 | AWG22 to AWG16 (0.30 to 1.25 mm ²) |
| Blade | BT1.25-9-1 BT1.25-10-1 W = 2.2 | AWG22 to AWG16 (0.30 to 1.25 mm ²) |

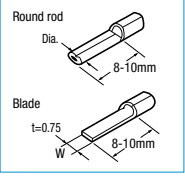

Note: Round rod and blade crimp terminals are made by Nichifu.

Dimensions

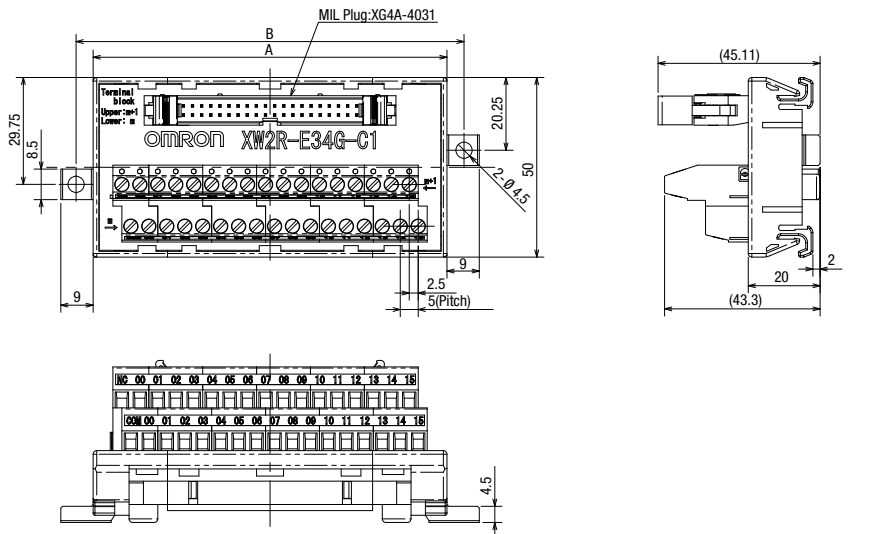

Wiring Diagram

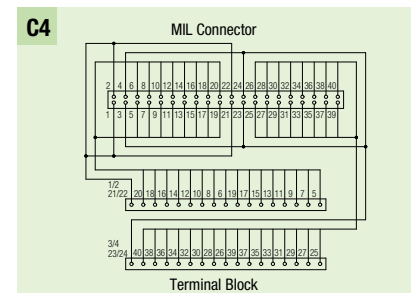
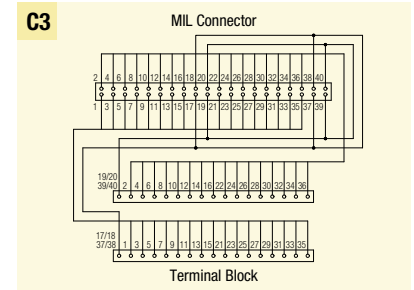
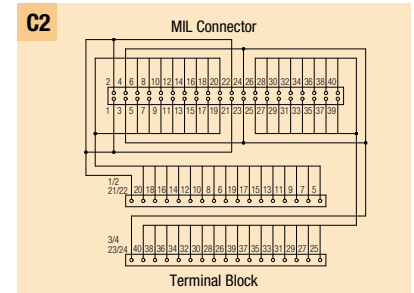
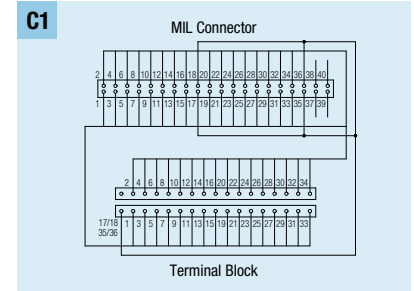

Label Contents

For C1 and C2

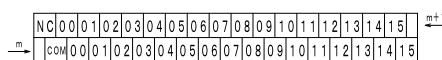

For C3 and C4

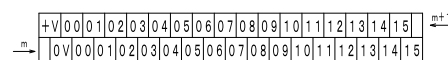

Models for Connection to OMRON PLCs

M3 Screw

| Appearance | I/O Points (number of poles) | Model | Dimension A(mm) | Dimension B(mm) |
|---|------------------------------|--------------|-----------------|-----------------|
|  | 32 (34) | XW2R-J34G-C1 | 130.7 | 140.2 |
| | 32 (34) | XW2R-J34G-C2 | 130.7 | 140.2 |
| | 32 (34) | XW2R-J34G-C3 | 130.7 | 140.2 |
| | 32 (34) | XW2R-J34G-C4 | 130.7 | 140.2 |

Ratings and Specifications

| | |
|-------------------------------|--|
| Rated current | 0.5A/signal, 4A/common |
| Rated voltage | 24VDC |
| Insulation resistance | 100MΩ min.(at 500VDC) |
| Dielectric strength | 500VAC for 1 min (leakage current: 1 mA max.) |
| Ambient operating temperature | 0 to 55°C |
| Applicable wires | Applicable wire sizes AWG 22 to 16 (round or forked crimp terminals) AWG 26 to 16 (twisted or solid wires) |
| | Stripped length 9 mm |

Details on Crimp Terminals

- **Wiring Terminal Blocks**
Use crimp terminals on terminal blocks with M3 screws.
- **Terminal Screw Tightening Torque**
Use a tightening torque of 0.5 N·m when connecting wires or crimp terminals to the terminal block.

| Applicable crimp terminals | Applicable wires |
|--------------------------------|---|
| Round crimp terminals 1.25-3 | AWG 22 to 16(0.30 to 1.25 mm ²) |
| Forked crimp terminals 1.25Y-3 | AWG 22 to 16(0.30 to 1.25 mm ²) |

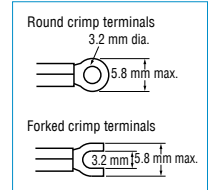

Dimensions

(Unit:mm)

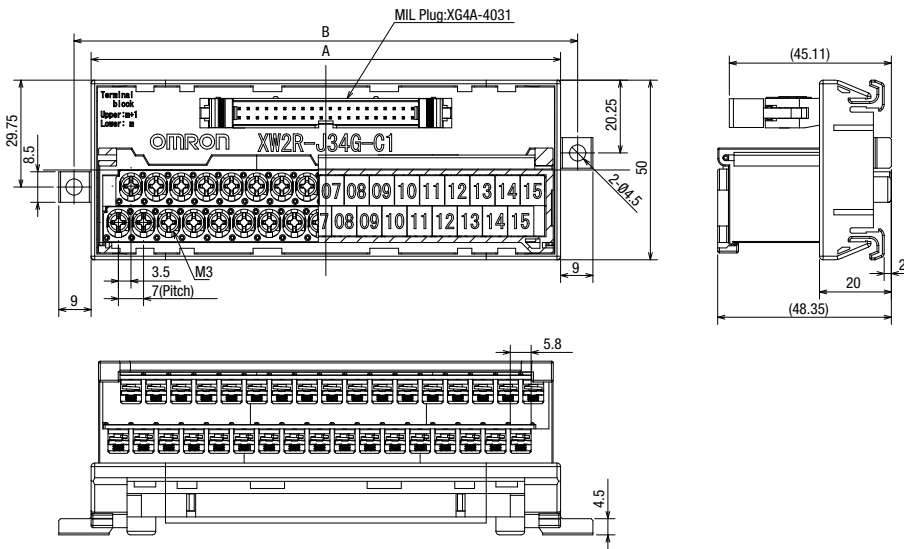

Wiring Diagram

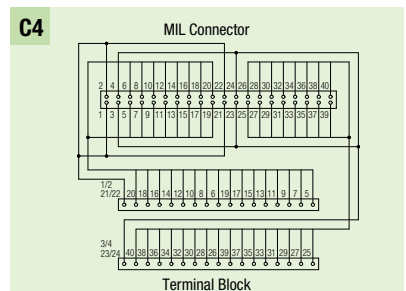
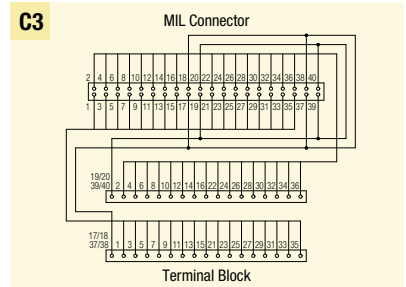
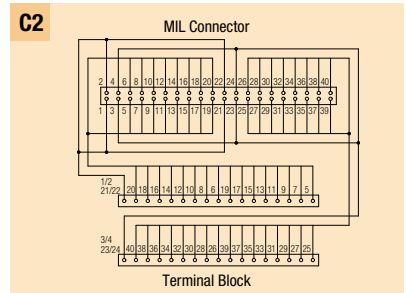
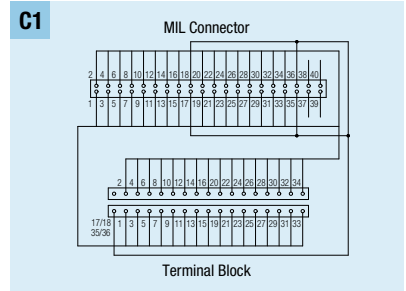

Label Contents

For C1 and C2

| | | | | | | | | | | | | | | | | |
|-----|----|----|----|----|----|----|----|----|----|----|----|----|----|----|----|----|
| NC | 00 | 01 | 02 | 03 | 04 | 05 | 06 | 07 | 08 | 09 | 10 | 11 | 12 | 13 | 14 | 15 |
| COM | 00 | 01 | 02 | 03 | 04 | 05 | 06 | 07 | 08 | 09 | 10 | 11 | 12 | 13 | 14 | 15 |

For C3 and C4

| | | | | | | | | | | | | | | | | |
|----|----|----|----|----|----|----|----|----|----|----|----|----|----|----|----|----|
| +V | 00 | 01 | 02 | 03 | 04 | 05 | 06 | 07 | 08 | 09 | 10 | 11 | 12 | 13 | 14 | 15 |
| 0V | 00 | 01 | 02 | 03 | 04 | 05 | 06 | 07 | 08 | 09 | 10 | 11 | 12 | 13 | 14 | 15 |

Models for Connection to Mitsubishi PLCs

Model List

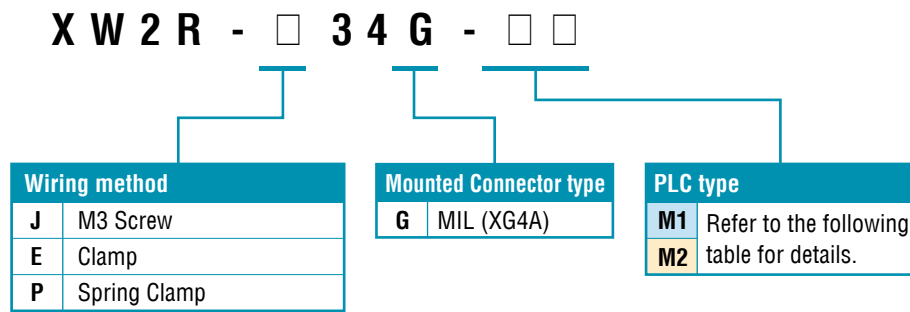

Models for Connection to Mitsubishi PLCs

| PLC Type | I/O Points | Mitsubishi PLC Module model | Connecting cables | | | |
|-------------------|--------------------|-----------------------------|---------------------|----|----------|--------------------|
| M1 | 32 | LX41C4 | XW2Z-□□□B: 1 cable | | | |
| | | QX41 | | | | |
| | | QX41-S1 | | | | |
| | | QX41-S2 | | | | |
| | | QX71 | | | | |
| | | QH42P (input) | | | | |
| | | QX41Y41P (input) | | | | |
| | | A1SX41-S1 | | | | |
| | | A1SX41-S2 | | | | |
| | | A1SX71 | | | | |
| | | A1SH42 (input) | | | | |
| | | A1SH42-S1 (input) | | | | |
| | 64 | LX42C4 | XW2Z-□□□B: 2 cables | | | |
| | | QX42 | | | | |
| | | QX42-S1 | | | | |
| | | QX82 | | | | |
| | | QX82-S1 | | | | |
| | | A1SX42-S1 | | | | |
| | | A1SX42-S2 | | | | |
| | | A1SX82-S | | | | |
| | | M2 | | 32 | LY41NT1P | XW2Z-□□□B: 1 cable |
| | | | | | QY41P | |
| QY71 | | | | | | |
| QH42P (output) | | | | | | |
| QY41Y41P (output) | | | | | | |
| A1SY41-S1 | | | | | | |
| A1SY41P | | | | | | |
| A1SY42P | | | | | | |
| A1SY71 | | | | | | |
| 64 | A1SH42 (output) | | XW2Z-□□□B: 2 cables | | | |
| | A1SH42-S1 (output) | | | | | |
| | LY42NT1P | | | | | |
| | QY42P | | | | | |
| A1SY42 | | | | | | |

*□□□ is replaced by the cable length.

*Refer to page 16 for information on Connecting Cables.

Models for Connection to OMRON PLCs

Spring Clamp

| Appearance | I/O Points (number of poles) | Model | Dimension A(mm) | Dimension B(mm) |
|---|------------------------------|--------------|-----------------|-----------------|
|  | 32 (34) | XW2R-P34G-C1 | 98.5 | 108 |
| | 32 (34) | XW2R-P34G-C2 | 98.5 | 108 |
| | 32 (34) | XW2R-P34G-C3 | 98.5 | 108 |
| | 32 (34) | XW2R-P34G-C4 | 98.5 | 108 |

Ratings and Specifications

| | | |
|-------------------------------|------------------------|---|
| Rated current | 0.5A/signal, 4A/common | |
| Rated voltage | 24VDC | |
| Insulation resistance | 100MΩ min. (at 500VDC) | |
| Dielectric strength | 500VAC for 1 min | |
| Ambient operating temperature | 0 to 55°C | |
| Applicable wires | Applicable wire sizes | AWG 24 to 14 (rod terminals), AWG 28 to 14 (twisted or solid wires) (Outer diameter of insulation must be 4 mm max) |
| | Stripped length | AWG28-16: 8 to 10 mm, AWG14: 9 to 10 mm |

Details on Crimp Terminals

● Applicable Ferrules

- Use ferrules of the lengths and thicknesses specified below. If other lengths or thicknesses are used, connection may not be possible or it may not be possible to insert or remove the posts.

• Ferrule Dimensions

| | | | |
|-----------------|------------------------|---------------------------------|---|
| Square ferrules | Dimension A (Width) | 2.7mm max. | The cross-sectional area after crimping must be 4.8 mm ² or less |
| | Dimension B (Height) | 2 mm max. | |
| Round ferrules | Dimension C (Diameter) | 2 mm dia. max. (after crimping) | |

• Special Tools

| | |
|-------|----------|
| Model | XW4Z-00B |
|-------|----------|

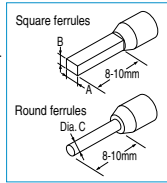

Dimensions

(Unit:mm)

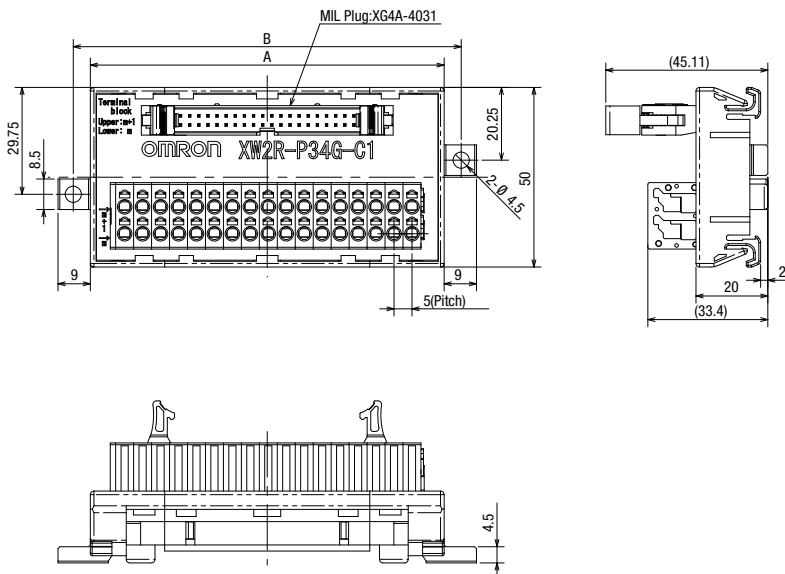

Wiring Diagram

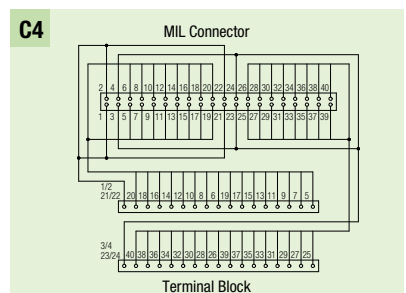
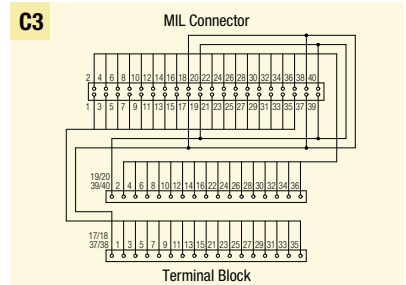
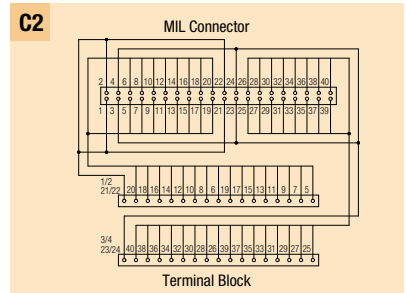
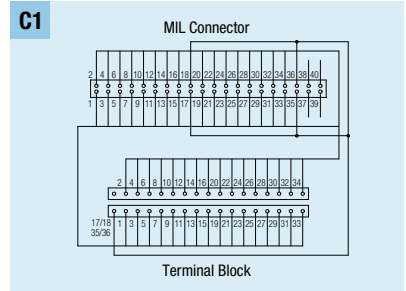

Label Contents

For C1 and C2

| | | | | | | | | | | | | | | | | | | | | |
|---|---|---|-----|---|---|---|---|---|---|---|---|---|---|---|----|----|----|----|----|----|
| m | + | 1 | NC | 0 | 0 | 1 | 2 | 3 | 4 | 5 | 6 | 7 | 8 | 9 | 10 | 11 | 12 | 13 | 14 | 15 |
| m | - | 1 | COM | 0 | 0 | 1 | 2 | 3 | 4 | 5 | 6 | 7 | 8 | 9 | 10 | 11 | 12 | 13 | 14 | 15 |

For C3 and C4

| | | | | | | | | | | | | | | | | | | | | |
|---|---|---|----|---|---|---|---|---|---|---|---|---|---|---|----|----|----|----|----|----|
| m | + | 1 | +V | 0 | 0 | 1 | 2 | 3 | 4 | 5 | 6 | 7 | 8 | 9 | 10 | 11 | 12 | 13 | 14 | 15 |
| m | - | 1 | 0V | 0 | 0 | 1 | 2 | 3 | 4 | 5 | 6 | 7 | 8 | 9 | 10 | 11 | 12 | 13 | 14 | 15 |

Models for Connection to Mitsubishi PLCs

Clamp

| Appearance | I/O Points (number of poles) | Model | Dimension A(mm) | Dimension B(mm) |
|---|------------------------------|--------------|-----------------|-----------------|
|  | 32 (34) | XW2R-E34G-M1 | 98.5 | 108 |
| | 32 (34) | XW2R-E34G-M2 | 98.5 | 108 |

Ratings and Specifications

| | |
|-------------------------------|---|
| Rated current | 0.5A/signal, 2A/common |
| Rated voltage | 24VDC |
| Insulation resistance | 100MΩ min. (at 500VDC) |
| Dielectric strength | 500VAC for 1 min (leakage current: 1 mA max.) |
| Ambient operating temperature | 0 to 55°C |
| Applicable wires | Applicable wire sizes |
| | AWG 22 to 16 (rod terminals) AWG 26 to 16 (twisted or solid wires) |
| Stripped length | 7 mm |

Details on Crimp Terminals

| Applicable crimp terminals | | Applicable wires |
|----------------------------|---------------------------|---|
| Rod | TC-05 Dia. = 1 | AWG22 to AWG18 (0.30 to 0.75 mm ²) |
| | TC-1.25S Dia. = 1.5 | AWG22 to AWG16 (0.30 to 1.25 mm ²) |
| Blade | BT1.25-9-1 BT1.25-10-1 | AWG22 to AWG16 (0.30 to 1.25 mm ²) |

Note: Round rod and blade crimp terminals are made by Nichifu.

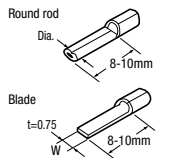

Dimensions

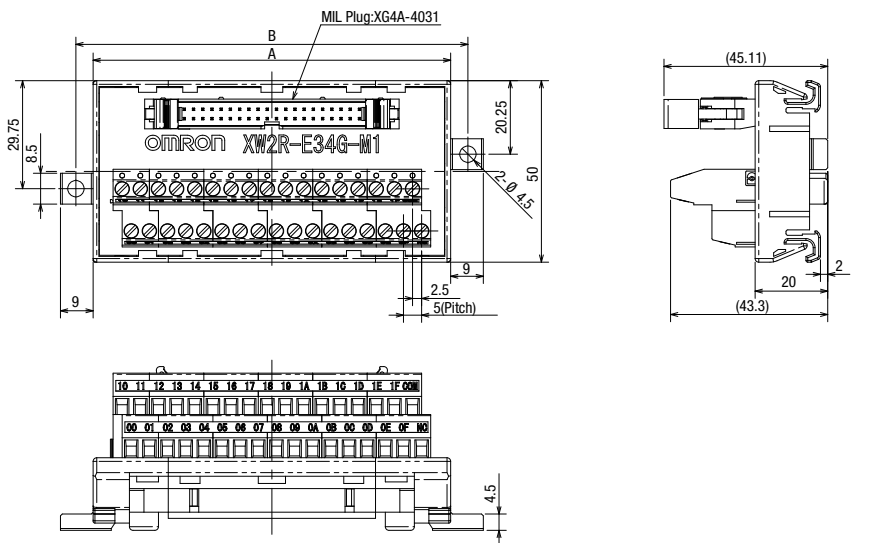

Wiring Diagram

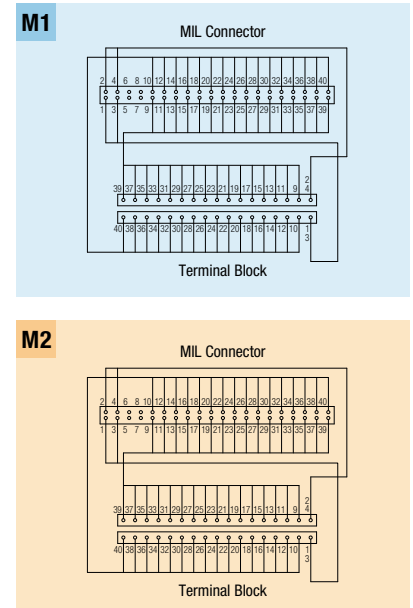

Label Contents

For M1

| | | | | | | | | | | | | | | | | |
|----|----|----|----|----|----|----|----|----|----|----|----|----|----|----|----|-----|
| 10 | 11 | 12 | 13 | 14 | 15 | 16 | 17 | 18 | 19 | 1A | 1B | 1C | 1D | 1E | 1F | COM |
| 00 | 01 | 02 | 03 | 04 | 05 | 06 | 07 | 08 | 09 | 0A | 0B | 0C | 0D | 0E | 0F | NC |

For M2

| | | | | | | | | | | | | | | | | |
|----|----|----|----|----|----|----|----|----|----|----|----|----|----|----|----|----|
| 10 | 11 | 12 | 13 | 14 | 15 | 16 | 17 | 18 | 19 | 1A | 1B | 1C | 1D | 1E | 1F | V |
| 00 | 01 | 02 | 03 | 04 | 05 | 06 | 07 | 08 | 09 | 0A | 0B | 0C | 0D | 0E | 0F | OV |

Models for Connection to Mitsubishi PLCs

M3 Screw

| Appearance | I/O Points (number of poles) | Model | Dimension A(mm) | Dimension B(mm) |
|---|------------------------------|--------------|-----------------|-----------------|
|  | 32 (34) | XW2R-J34G-M1 | 130.7 | 140.2 |
| | 32 (34) | XW2R-J34G-M2 | 130.7 | 140.2 |

Ratings and Specifications

| | |
|-------------------------------|---|
| Rated current | 0.5A/signal, 2A/common |
| Rated voltage | 24VDC |
| Insulation resistance | 100MΩ min. (at 500VDC) |
| Dielectric strength | 500VAC for 1 min (leakage current: 1 mA max.) |
| Ambient operating temperature | 0 to 55°C |
| Applicable wires | Applicable wire sizes |
| | Stripped length |

AWG 22 to 16 (round or forked crimp terminals)
AWG 26 to 16 (twisted or solid wires)
9 mm

Details on Crimp Terminals

- **Wiring Terminal Blocks**
Use crimp terminals on terminal blocks with M3 screws.
- **Terminal Screw Tightening Torque**
Use a tightening torque of 0.5 N-m when connecting wires or crimp terminals to the terminal block.

| Applicable crimp terminals | Applicable wires |
|----------------------------|---|
| Round crimp terminals | 1.25-3 AWG 22 to 16(0.30 to 1.25 mm ²) |
| Forked crimp terminals | 1.25Y-3 AWG 22 to 16(0.30 to 1.25 mm ²) |

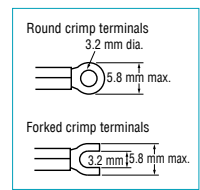

Dimensions

(Unit:mm)

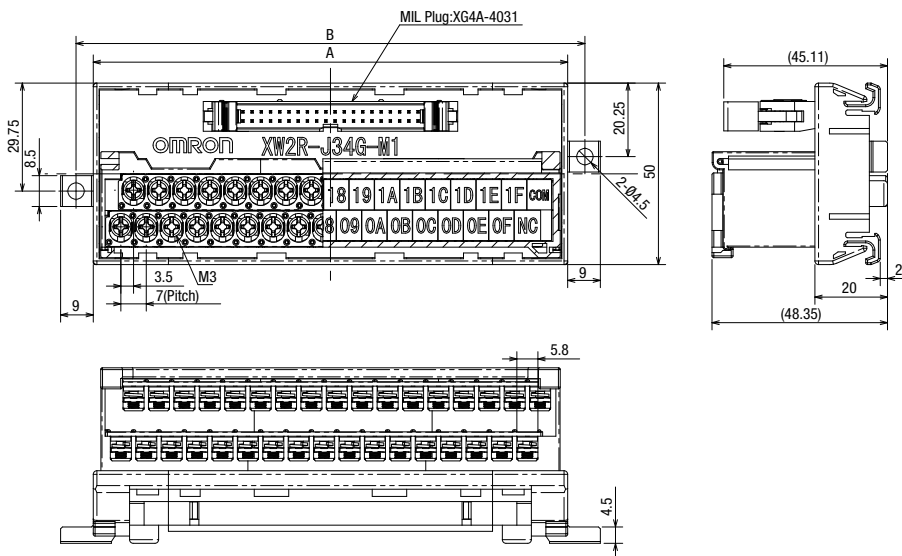

Wiring Diagram

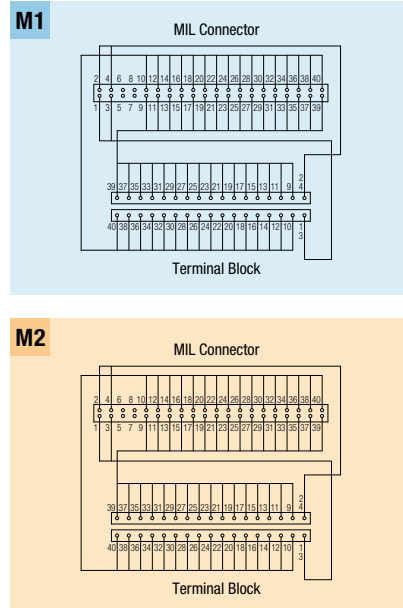

Label Contents

For M1

| | | | | | | | | | | | | | | | | | | | | | | | | | | | | | | | | |
|---|---|---|---|---|---|---|---|---|---|---|---|---|---|---|---|---|---|-----|---|---|---|---|---|---|---|---|---|---|---|---|---|----|
| 1 | 0 | 1 | 1 | 2 | 3 | 4 | 5 | 6 | 7 | 8 | 9 | A | B | C | D | E | F | COM | | | | | | | | | | | | | | |
| 0 | 0 | 0 | 1 | 0 | 2 | 0 | 3 | 0 | 4 | 0 | 5 | 0 | 6 | 0 | 7 | 0 | 8 | 0 | 9 | 0 | A | 0 | B | 0 | C | 0 | D | 0 | E | 0 | F | NC |

For M2

| | | | | | | | | | | | | | | | | | | | | | | | | | | | | | | | | | |
|---|---|---|---|---|---|---|---|---|---|---|---|---|---|---|---|---|---|---|---|---|---|---|---|---|---|---|---|---|---|---|---|---|---|
| 1 | 0 | 1 | 1 | 2 | 3 | 4 | 5 | 6 | 7 | 8 | 9 | A | B | C | D | E | F | V | | | | | | | | | | | | | | | |
| 0 | 0 | 0 | 1 | 0 | 2 | 0 | 3 | 0 | 4 | 0 | 5 | 0 | 6 | 0 | 7 | 0 | 8 | 0 | 9 | 0 | A | 0 | B | 0 | C | 0 | D | 0 | E | 0 | F | 0 | V |

Model List

XW2R - □ □ □ □ □ - T

| Wiring method | |
|---------------|--------------|
| J | M3 Screw |
| E | Clamp |
| P | Spring Clamp |
| N | e-CON* |

| Number of poles | |
|-----------------|-----------|
| | 20 |
| | 34 |
| | 40 |
| | 50 |
| | 60 |

| Mounted Connector type | |
|------------------------|-------------|
| G | MIL (XG4A) |
| C | MIL (XG4C)* |
| F | FCN* |
| D | D-sub* |
| R | MR* |
| M | MDR* |

| Plug/Socket | |
|--------------|------------------|
| Blank | Plug (male) |
| R | Socket (female)* |

* Scheduled for release soon.

M3 Screw

| Appearance | number of poles | Model | Dimension A(mm) | Dimension B(mm) |
|--|-----------------|-------------|-----------------|-----------------|
|  | 20 | XW2R-J20G-T | 81.7 | 91.2 |
| | 34 | XW2R-J34G-T | 130.7 | 140.2 |
| | 40 | XW2R-J40G-T | 151.7 | 161.2 |
| | 50 | XW2R-J50G-T | 186.7 | 196.2 |
| | 60 | XW2R-J60G-T | 221.7 | 231.2 |

Ratings and Specifications

| | |
|-------------------------------|---|
| Rated current | 1A |
| Rated voltage | 125VAC 24VDC |
| Insulation resistance | 100MΩ min.(at 500VDC) |
| Dielectric strength | 500VAC for 1 min (leakage current: 1 mA max.) |
| Ambient operating temperature | 0 to 55°C |

*The details on crimp terminals are the same for the XW2R-J34G on page 6.

Label Contents

| | | | | | | | | | | | | | | | | |
|----|----|----|----|----|----|----|----|----|-----|-----|-----|-----|-----|-----|-----|-----|
| B1 | B2 | B3 | B4 | B5 | B6 | B7 | B8 | B9 | B10 | B11 | B12 | B13 | B14 | B15 | B16 | B17 |
| A1 | A2 | A3 | A4 | A5 | A6 | A7 | A8 | A9 | A10 | A11 | A12 | A13 | A14 | A15 | A16 | A17 |

*The label contents for a Terminal Block with 34 poles are shown.

Dimensions

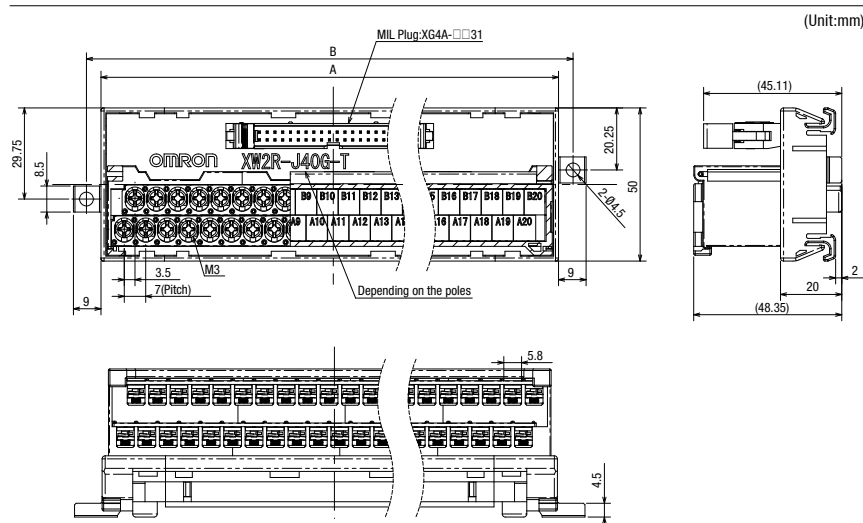

Wiring Diagram

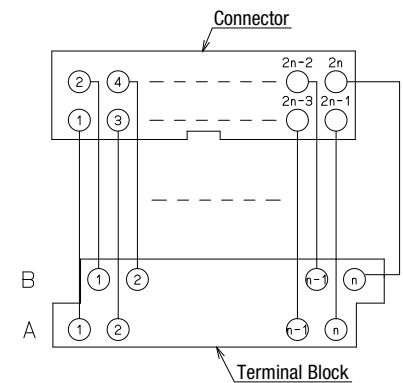

Models for Connection to Mitsubishi PLCs

Spring Clamp

| Appearance | I/O Points (number of poles) | Model | Dimension A(mm) | Dimension B(mm) |
|---|------------------------------|--------------|-----------------|-----------------|
|  | 32 (34) | XW2R-P34G-M1 | 98.5 | 108 |
| | 32 (34) | XW2R-P34G-M2 | 98.5 | 108 |

Ratings and Specifications

| | | |
|-------------------------------|------------------------|---|
| Rated current | 0.5A/signal, 2A/common | |
| Rated voltage | 24VDC | |
| Insulation resistance | 100MΩ min. (at 500VDC) | |
| Dielectric strength | 500VAC for 1 min | |
| Ambient operating temperature | 0 to 55°C | |
| Applicable wires | Applicable wire sizes | AWG 24 to 14 (rod terminals), AWG 28 to 14 (twisted or solid wires) (Outer diameter of insulation must be 4 mm max) |
| | Stripped length | AWG28-16: 8 to 10 mm, AWG14: 9 to 10 mm |

Details on Crimp Terminals

● Applicable Ferrules

- Use ferrules of the lengths and thicknesses specified below. If other lengths or thicknesses are used, connection may not be possible or it may not be possible to insert or remove the posts.

• Ferrule Dimensions

| | | | |
|-----------------|------------------------|---------------------------------|---|
| Square ferrules | Dimension A (Width) | 2.7 mm max | The cross-sectional area after crimping must be 4.8 mm ² or less |
| | Dimension B (Height) | 2 mm max. | |
| Round ferrules | Dimension C (Diameter) | 2 mm dia. max. (after crimping) | |

• Special Tools

Model XW4Z-00B

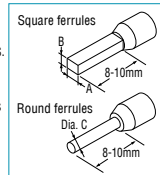

Dimensions

(Unit:mm)

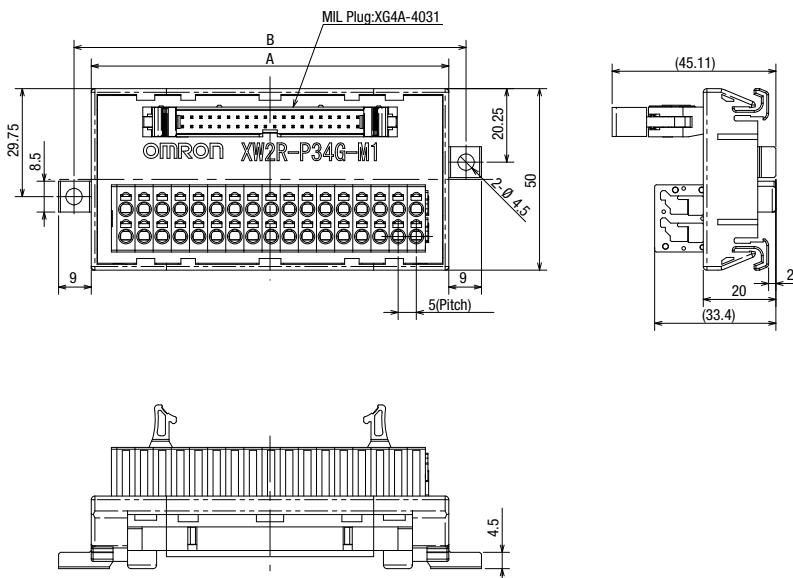

Wiring Diagram

M1

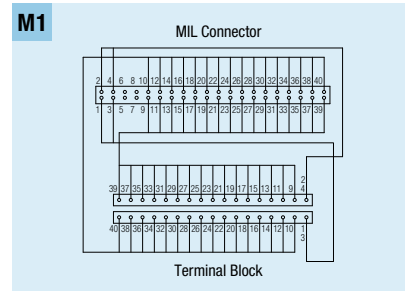

M2

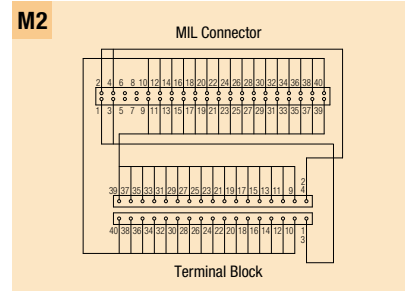

Label Contents

For M1

| | | | | | | | | | | | | | | | | | | | | | | | | | | | | | | | | |
|---|---|---|---|---|---|---|---|---|---|---|---|---|---|---|---|---|---|---|---|---|---|---|---|---|---|---|---|---|---|---|---|-----|
| 1 | 0 | 1 | 1 | 1 | 2 | 1 | 3 | 1 | 4 | 1 | 5 | 1 | 6 | 1 | 7 | 1 | 8 | 1 | 9 | 1 | A | 1 | B | 1 | C | 1 | D | 1 | E | 1 | F | COM |
| 0 | 0 | 0 | 1 | 0 | 2 | 0 | 3 | 0 | 4 | 0 | 5 | 0 | 6 | 0 | 7 | 0 | 8 | 0 | 9 | 0 | A | 0 | B | 0 | C | 0 | D | 0 | E | 0 | F | NC |

For M2

| | | | | | | | | | | | | | | | | | | | | | | | | | | | | | | | | |
|---|---|---|---|---|---|---|---|---|---|---|---|---|---|---|---|---|---|---|---|---|---|---|---|---|---|---|---|---|---|---|---|----|
| 1 | 0 | 1 | 1 | 1 | 2 | 1 | 3 | 1 | 4 | 1 | 5 | 1 | 6 | 1 | 7 | 1 | 8 | 1 | 9 | 1 | A | 1 | B | 1 | C | 1 | D | 1 | E | 1 | F | +V |
| 0 | 0 | 0 | 1 | 0 | 2 | 0 | 3 | 0 | 4 | 0 | 5 | 0 | 6 | 0 | 7 | 0 | 8 | 0 | 9 | 0 | A | 0 | B | 0 | C | 0 | D | 0 | E | 0 | F | 0V |

Spring Clamp

| Appearance | number of poles | Model | Dimension A(mm) | Dimension B(mm) |
|---|-----------------|-------------|-----------------|-----------------|
|  | 20 | XW2R-P20G-T | 64.4 | 73.9 |
| | 34 | XW2R-P34G-T | 98.5 | 108 |
| | 40 | XW2R-P40G-T | 113.5 | 123 |
| | 50 | XW2R-P50G-T | 138.5 | 148 |
| | 60 | XW2R-P60G-T | 163.5 | 173 |

Ratings and Specifications

| | | |
|-------------------------------|---|--|
| Rated current | 1A | |
| Rated voltage | 125VAC 24VDC | |
| Insulation resistance | 100MΩ min.(at 500VDC) | |
| Dielectric strength | 500VAC for 1 min (leakage current: 1 mA max.) | |
| Ambient operating temperature | 0 to 55°C | |
| Applicable wires | Applicable wire sizes | AWG 24 to 14 (rod terminals), AWG 28 to 14 (twisted or solid wires)(Outer diameter of insulation must be 4 mm max) |
| | Stripped length | AWG28-16: 8 to 10 mm, AWG14: 9 to 10 mm |

*The details on crimp terminals are the same for the XW2R-P34G on page 8.

Label Contents

| | | | | | | | | | | | | | | | | | |
|---|---|---|---|---|---|---|---|---|---|----|----|----|----|----|----|----|----|
| B | 1 | 2 | 3 | 4 | 5 | 6 | 7 | 8 | 9 | 10 | 11 | 12 | 13 | 14 | 15 | 16 | 17 |
| A | 1 | 2 | 3 | 4 | 5 | 6 | 7 | 8 | 9 | 10 | 11 | 12 | 13 | 14 | 15 | 16 | 17 |

*The label contents for a Terminal Block with 34 poles are shown.

Dimensions

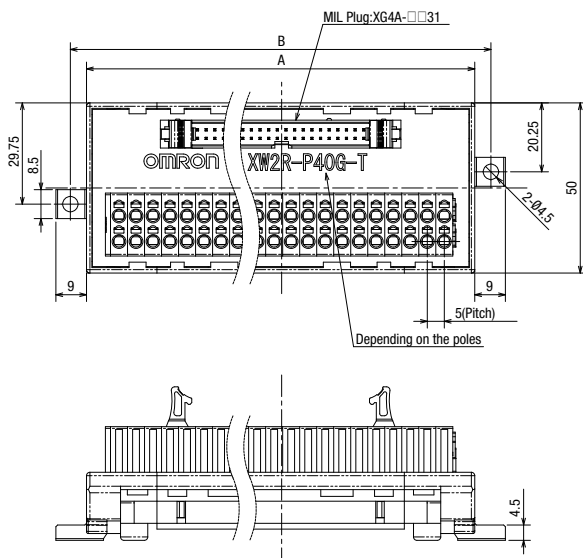

(Unit:mm)

Wiring Diagram

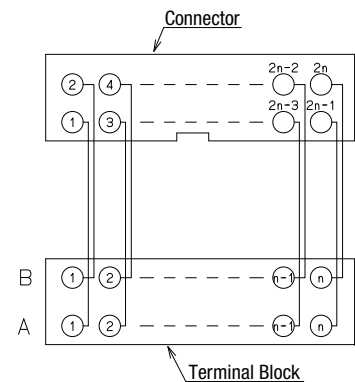

Clamp

| Appearance | number of poles | Model | Dimension A(mm) | Dimension B(mm) |
|---|-----------------|-------------|-----------------|-----------------|
|  | 20 | XW2R-E20G-T | 64.4 | 73.9 |
| | 34 | XW2R-E34G-T | 98.5 | 108 |
| | 40 | XW2R-E40G-T | 113.5 | 123 |
| | 50 | XW2R-E50G-T | 138.5 | 148 |
| | 60 | XW2R-E60G-T | 163.5 | 173 |

Ratings and Specifications

| | |
|-------------------------------|---|
| Rated current | 1A |
| Rated voltage | 125VAC 24VDC |
| Insulation resistance | 100MΩ min.(at 500VDC) |
| Dielectric strength | 500VAC for 1 min (leakage current: 1 mA max.) |
| Ambient operating temperature | 0 to 55°C |

*The details on crimp terminals are the same for the XW2R-E34G on page 7.

Label Contents

| | | | | | | | | | | | | | | | | | |
|---|---|---|---|---|---|---|---|---|---|----|----|----|----|----|----|----|----|
| B | 1 | 2 | 3 | 4 | 5 | 6 | 7 | 8 | 9 | 10 | 11 | 12 | 13 | 14 | 15 | 16 | 17 |
| A | 1 | 2 | 3 | 4 | 5 | 6 | 7 | 8 | 9 | 10 | 11 | 12 | 13 | 14 | 15 | 16 | 17 |

*The label contents for a Terminal Block with 34 poles are shown.

Dimensions

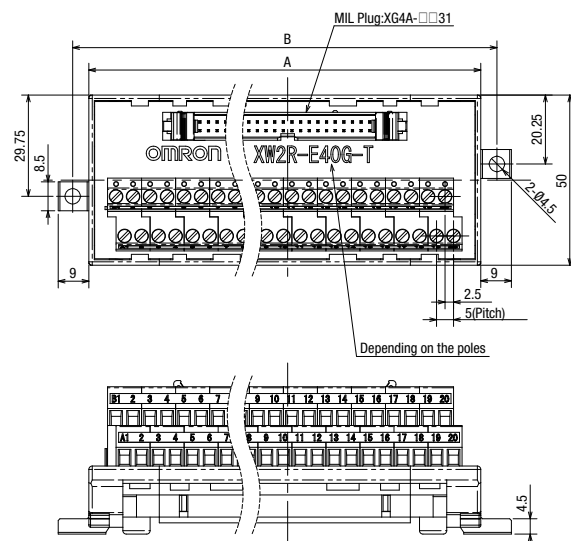

(Unit:mm)

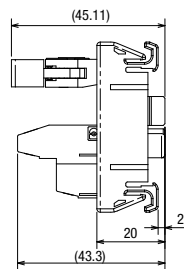

Wiring Diagram

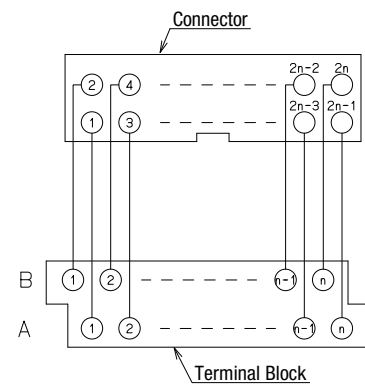

Connecting Cables

XW2Z-□□□D

Connectors: One 40-pin Connector Made by Fujitsu Component, Ltd. to Two 20-pin MIL Connectors

| Appearance | Model | Cable length L (m) | |
|---|-----------|--------------------|-------|
| | | A | B |
|  | XW2Z-100D | 1 | 0.75 |
| | XW2Z-150D | 1.5 | 1.25 |
| | XW2Z-200D | 2 | 1.75 |
| | XW2Z-300D | 3 | 2.75 |
| | XW2Z-500D | 5 | 4.75 |
| | XW2Z-010D | 10 | 9.75 |
| | XW2Z-15MD | 15 | 14.75 |
| | XW2Z-20MD | 20 | 19.75 |

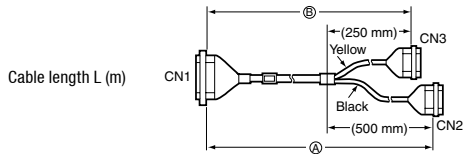

Wiring Diagram

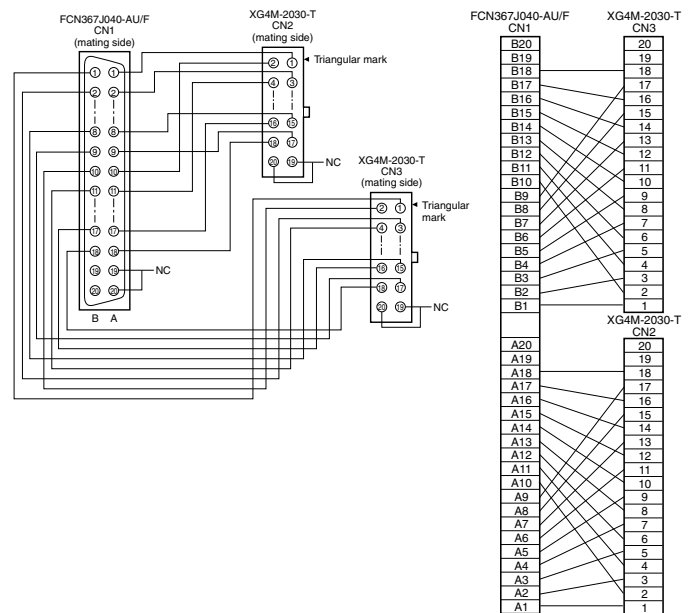

XW2Z-□□□F

Connectors: One 20-pin MIL Connector to 20 Loose Wires with Crimp Terminals Attached

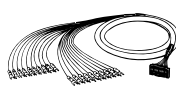
| Appearance | Model | Cable length L (m) |
|---|-----------|--------------------|
|  | XW2Z-100F | 1 |
| | XW2Z-150F | 1.5 |
| | XW2Z-200F | 2 |
| | XW2Z-300F | 3 |
| | XW2Z-500F | 5 |
| | XW2Z-010F | 10 |
| | XW2Z-15MF | 15 |
| | XW2Z-20MF | 20 |

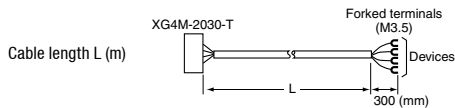

Wiring Diagram

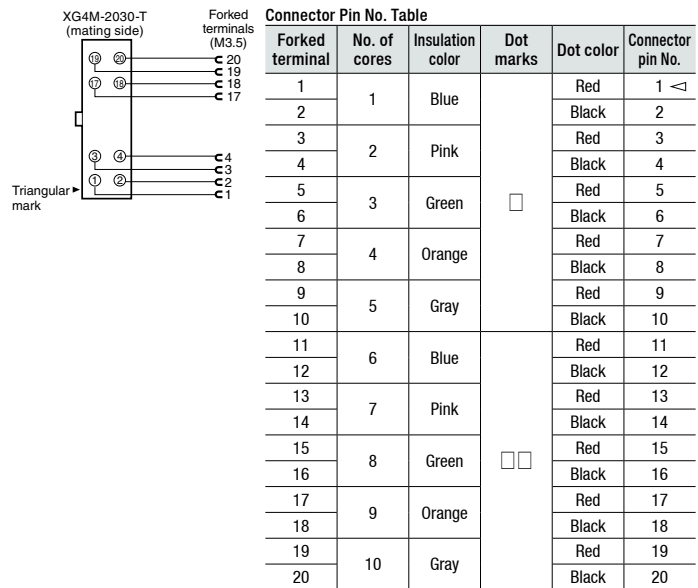

XW2Z-□□□K

Connectors: One 40-pin MIL Connector to One 40-pin MIL Connector

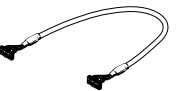
| Appearance | Model | Cable length L (m) |
|---|-----------|--------------------|
|  | XW2Z-C25K | 0.25 |
| | XW2Z-C50K | 0.5 |
| | XW2Z-100K | 1 |
| | XW2Z-150K | 1.5 |
| | XW2Z-200K | 2 |
| | XW2Z-300K | 3 |
| | XW2Z-500K | 5 |
| | XW2Z-010K | 10 |

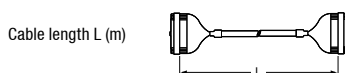

Wiring Diagram

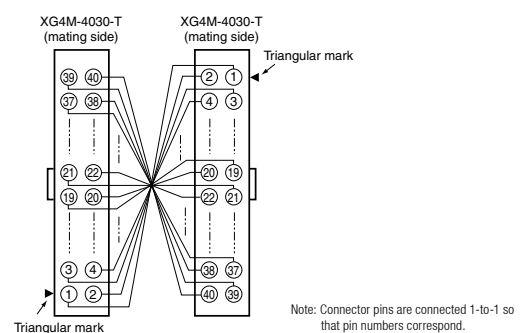

XW2Z

Appearance



Ratings and Specifications

| | |
|-------------------------------|---|
| Rated current | 1A |
| Rated voltage | 125 VAC 24 VDC |
| Contact resistance | 20 mΩ max. (at 20 mV, 100 mA max.) *1 |
| Insulation resistance | 100 MΩ min. (at 500 VDC) |
| Dielectric strength | 500 VAC for 1 min (leakage current: 1 mA max.) *2 |
| Ambient operating temperature | 25 to 80°C |

*1. Contact resistance for the Connector. *2. Dielectric strength for the Connector.

Materials and Finish

| Item | Part name | Materials and Finish | |
|------------------|--|--------------------------------|---|
| Connectors | XG4M-2030 XG4M-4030 | Housing | Fiber-glass reinforced PBT resin (UL94V-0)/black |
| | | Cover | |
| | Contacts | Mating end | Phosphor bronze/nickel base, 0.15-μm gold plating |
| | | Press-fit end | Phosphor bronze/nickel base, 2.0-μm tin plating |
| | XG4T-2004/4004 | Strain Relief | Fiber-glass reinforced PBT resin (UL94V-0)/black |
| | FCN-367J024-AU/F * FCN-367J040-AU/F | Housing | Polyester resin (UL94V-0)/black |
| Contacts | | Mating end | Copper alloy/gold plated |
| | | Press-fit end | Copper alloy/tin plated |
| Connecting screw | Steel/nickel plated | | |
| Cable | UL2464 Interface Cable | AWG28 | |
| Crimp terminal | Forked crimp terminal | 1.25 YAS 3.5 or the equivalent | |

* These housings, contacts, and connecting screws are made by Fujitsu Component, Ltd.

XW2Z-□□□A

Connectors: One 24-pin Connector Made by Fujitsu Component, Ltd. to One 20-pin MIL Connector

| Appearance | Model | Cable length L (m) |
|------------|-----------|--------------------|
| | XW2Z-050A | 0.5 |
| | XW2Z-100A | 1 |
| | XW2Z-150A | 1.5 |
| | XW2Z-200A | 2 |
| | XW2Z-300A | 3 |
| | XW2Z-500A | 5 |
| | XW2Z-700A | 7 |
| | XW2Z-010A | 10 |
| | XW2Z-15MA | 15 |
| | XW2Z-20MA | 20 |

Wiring Diagram

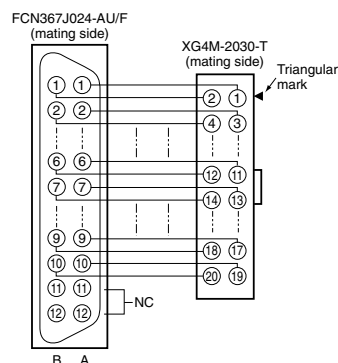

Cable length L (m)

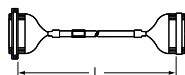

XW2Z-□□□B

Connectors: One 40-pin Connector Made by Fujitsu Component, Ltd. to One 40-pin MIL Connector

| Appearance | Model | Cable length L (m) |
|------------|-----------|--------------------|
| | XW2Z-050B | 0.5 |
| | XW2Z-100B | 1 |
| | XW2Z-150B | 1.5 |
| | XW2Z-200B | 2 |
| | XW2Z-300B | 3 |
| | XW2Z-500B | 5 |
| | XW2Z-700B | 7 |
| | XW2Z-010B | 10 |
| | XW2Z-15MB | 15 |
| | XW2Z-20MB | 20 |

Wiring Diagram

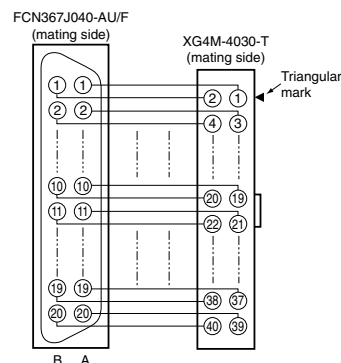

Cable length L (m)

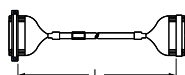

Safety Precautions

Precautions for Correct Use

● Wiring Precautions

- Do not perform wiring work, remove connectors, or connect connectors while power is being supplied.
Electric shock or damage to the device may result.
- Double-check all wiring before turning ON the power supply.
- After wiring, route the cable so that force is not applied directly to the connections.

● Wires for Terminal Blocks

- Do not damage the cores when stripping the insulation from them.
- Always twist stranded wires together before connecting them.
- Do not presolder wires. It may not be possible to connect them or remove them.

Connecting Cables

XW2Z-□□□L

Connectors: One 40-pin Connector Made by Fujitsu Component, Ltd. to Two 20-pin MIL Connectors

| Appearance | Model | Cable length L (m) | |
|---|-----------|--------------------|-------|
| | | A | B |
|  | XW2Z-100L | 1 | 0.75 |
| | XW2Z-150L | 1.5 | 1.25 |
| | XW2Z-200L | 2 | 1.75 |
| | XW2Z-300L | 3 | 2.75 |
| | XW2Z-500L | 5 | 4.75 |
| | XW2Z-010L | 10 | 9.75 |
| | XW2Z-15ML | 15 | 14.75 |
| | XW2Z-20ML | 20 | 19.75 |

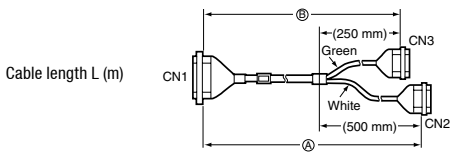

Wiring Diagram

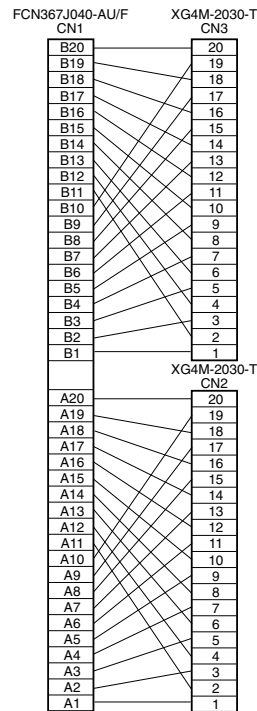

XW2Z-□□□N

Connectors: One 40-pin MIL Connector to Two 20-pin MIL Connectors

| Appearance | Model | Cable length L (m) | |
|---|-----------|--------------------|-------|
| | | A | B |
|  | XW2Z-100N | 1 | 0.75 |
| | XW2Z-150N | 1.5 | 1.25 |
| | XW2Z-200N | 2 | 1.75 |
| | XW2Z-300N | 3 | 2.75 |
| | XW2Z-500N | 5 | 4.75 |
| | XW2Z-010N | 10 | 9.75 |
| | XW2Z-15MN | 15 | 14.75 |
| | XW2Z-20MN | 20 | 19.75 |

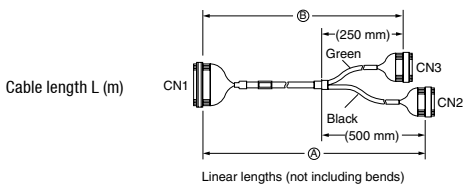

Wiring Diagram

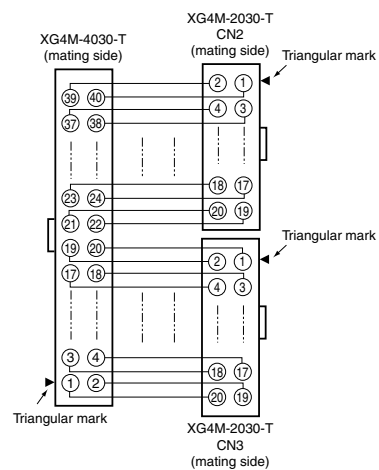

XW2Z-□□□X

Connectors: One 20-pin MIL Connector to One 20-pin MIL Connector

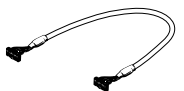
| Appearance | Model | Cable length L (m) |
|---|-----------|--------------------|
| | | |
|  | XW2Z-100X | 1 |
| | XW2Z-200X | 2 |
| | XW2Z-300X | 3 |
| | XW2Z-500X | 5 |
| | XW2Z-010X | 10 |

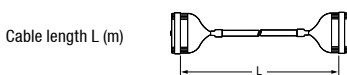

Wiring Diagram

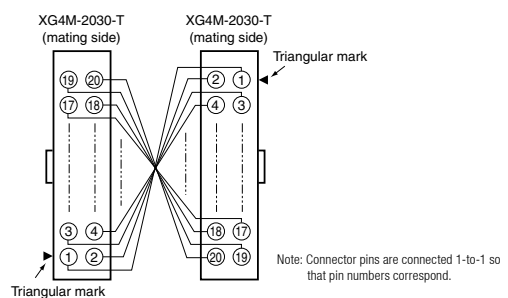

OMRON AUTOMATION AND SAFETY • THE AMERICAS HEADQUARTERS • Schaumburg, IL USA • 847.843.7900 • 800.556.6766 • www.omron247.com

OMRON CANADA, INC. • HEAD OFFICE

Toronto, ON, Canada • 416.286.6465 • 866.986.6766 • www.omron247.com

OMRON ELECTRONICS DE MEXICO • HEAD OFFICE

México DF • 52.55.59.01.43.00 • 001.800.556.6766 • mela@omron.com

OMRON ELECTRONICS DE MEXICO • SALES OFFICE

Apodaca, N.L. • 52.81.11.56.99.20 • 001.800.556.6766 • mela@omron.com

OMRON ELETRÔNICA DO BRASIL LTDA • HEAD OFFICE

São Paulo, SP, Brasil • 55.11.2101.6300 • www.omron.com.br

OMRON ARGENTINA • SALES OFFICE

Cono Sur • 54.11.4783.5300

OMRON CHILE • SALES OFFICE

Santiago • 56.9.9917.3920

OTHER OMRON LATIN AMERICA SALES

54.11.4783.5300

OMRON EUROPE B.V. • Wegalaan 67-69, NL-2132 JD, Hoofddorp, The Netherlands. • Tel: +31 (0) 23 568 13 00 • Fax: +31 (0) 23 568 13 88 • www.industrial.omron.eu

Authorized Distributor:

Automation Control Systems

- Machine Automation Controllers (MAC) • Programmable Controllers (PLC)
- Operator interfaces (HMI) • Distributed I/O • Software

Drives & Motion Controls

- Servo & AC Drives • Motion Controllers & Encoders

Temperature & Process Controllers

- Single and Multi-loop Controllers

Sensors & Vision

- Proximity Sensors • Photoelectric Sensors • Fiber-Optic Sensors
- Amplified Photomicrosensors • Measurement Sensors
- Ultrasonic Sensors • Vision Sensors • RFID/Code Readers

Industrial Components

- Relays • Pushbuttons & Indicators • Limit and Basic Switches • Timers
- Counters • Metering Devices • Power Supplies

Safety

- Laser Scanners • Safety Mats • Edges and Bumpers
- Programmable Safety Controllers • Light Curtains • Safety Relays
- Safety Interlock Switches

Mouser Electronics

Authorized Distributor

Click to View Pricing, Inventory, Delivery & Lifecycle Information:

Omron:

[XW2R-E34G-C3](#) [XW2R-J34G-C4](#) [XW2R-E40G-T](#) [XW2R-E20G-T](#) [XW2R-J34G-C3](#) [XW2R-J40G-T](#) [XW2R-E34G-C4](#)
[XW2R-J20G-T](#) [XW2R-P34G-C1](#) [XW2R-J34G-C2](#) [XW2R-P34G-C3](#) [XW2R-P34G-C4](#) [XW2R-E34G-C1](#) [XW2R-](#)
[E34G-C2](#) [XW2R-J34G-C1](#) [XW2R-P20G-T](#) [XW2R-P34G-C2](#) [XW2R-P40G-T](#)

Данный компонент на территории Российской Федерации

Вы можете приобрести в компании MosChip.

Для оперативного оформления запроса Вам необходимо перейти по данной ссылке:

<http://moschip.ru/get-element>

Вы можете разместить у нас заказ для любого Вашего проекта, будь то серийное производство или разработка единичного прибора.

В нашем ассортименте представлены ведущие мировые производители активных и пассивных электронных компонентов.

Нашей специализацией является поставка электронной компонентной базы двойного назначения, продукции таких производителей как XILINX, Intel (ex.ALTERA), Vicor, Microchip, Texas Instruments, Analog Devices, Mini-Circuits, Amphenol, Glenair.

Сотрудничество с глобальными дистрибьюторами электронных компонентов, предоставляет возможность заказывать и получать с международных складов практически любой перечень компонентов в оптимальные для Вас сроки.

На всех этапах разработки и производства наши партнеры могут получить квалифицированную поддержку опытных инженеров.

Система менеджмента качества компании отвечает требованиям в соответствии с ГОСТ Р ИСО 9001, ГОСТ РВ 0015-002 и ЭС РД 009

Офис по работе с юридическими лицами:

105318, г.Москва, ул.Щербаковская д.3, офис 1107, 1118, ДЦ «Щербаковский»

Телефон: +7 495 668-12-70 (многоканальный)

Факс: +7 495 668-12-70 (доб.304)

E-mail: info@moschip.ru

Skype отдела продаж:

moschip.ru

moschip.ru_4

moschip.ru_6

moschip.ru_9