

SWITCHING REGULATOR CONTROL IC FOR FLYBACK

■ GENERAL DESCRIPTION

The NJM2368 is a high speed switching regulator control IC which can operate at low voltage.

It uses a totempole output circuit, so that it can drive an external Bipolar Transistor directly.

It is suitable for applications of flyback type switching regulation of up to 10W.

■ PACKAGE OUTLINE

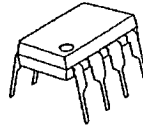

NJM2368D

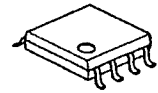

NJM2368M

■ FEATURES

- Operating Voltage (3.6~32V)
- Wide Oscillator Range (5~350 kHz)
- Soft-Start Function.
- Under Voltage Lockouts (U.V.L.O.)
- Bipolar Technology
- Package Outline DIP8, DMP8, EMP8, SSOP8



NJM2368E



NJM2368V

■ BLOCK DIAGRAM

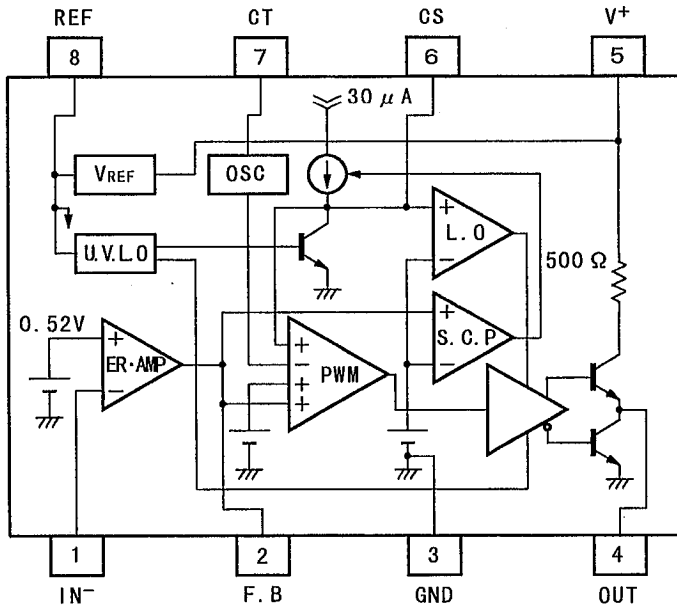

- PIN FUNCTION
1. IN⁻
 2. F. B
 3. GND
 4. OUT
 5. V⁺
 6. CS
 7. CT
 8. REF

■ ABSOLUTE MAXIMUM RATINGS (T_a = 25°C)

PARAMETER	SYMBOL	MAXIMUM RATINGS	UNIT
Input Voltage	V ⁺	36	V
Reference Output Current	I _{OR}	10	mA
Output Current	I _O	±50	mA
Power Dissipation	P _D	(DIP8) 700 (DMP8) 300 (EMP8) 300 (SSOP8) 250	mW
Operating Temperature Range	T _{OPR}	-40~+85	°C
Storage Temperature Range	T _{STG}	-50~+125	°C

■ RECOMMENDED OPERATING CONDITIONS (V⁺ = 6V, T_a = 25°C)

PARAMETER	SYMBOL	RATINGS	MIN.	MAX.	UNIT
Operating Voltage	V ⁺		3.6	32	V
Feed Back Resistor	R _{NF}		100	—	kΩ
Oscillator Timing Capacitor	C _T		220	22000	pF
Oscillator Timing Resistor	R _T		10	100	kΩ
Oscillate	f _{OSC}		5	350	kHz

■ ELECTRICAL CHARACTERISTICS

(V⁺ = 6V, R_T = 33kΩ, C_T = 1000pF, T_a = 25°C)

REFERENCE VOLTAGE BLOCK

PARAMETER	SYMBOL	RATINGS	MIN.	TYP.	MAX.	UNIT
Output Voltage	V _{REF}	I _{OR} = 1mA	2.45	2.50	2.55	V
Line Regulation	L _{LINE}	V ⁺ = 3.6~32V, I _{OR} = 1mA	—	6.8	20.7	mV
Load Regulation	L _{LOAD}	I _{OR} = 0.1~5.0mA	—	5	30	mV

OSCILLATOR BLOCK

PARAMETER	SYMBOL	RATINGS	MIN.	TYP.	MAX.	UNIT
Oscillate	f _{OSC}	C _T = 1000pF, R _T = 33kΩ	85	105	125	kHz
Oscillate Fluctuations1 (Line Fluctuations)	f _{dv}	V ⁺ = 3.6~32V	—	1	—	%
Oscillate Fluctuations2 (Temp Fluctuations)	f _{dt}	T _a = -40~+85°C	—	5	—	%

■ ELECTRICAL CHARACTERISTICS

($V^+ = 6V$, $R_T = 33k\Omega$, $C_T = 1000pF$, $T_a = 25^\circ C$)

ERROR AMPLIFIER BLOCK

PARAMETER	SYMBOL	RATINGS	MIN.	TYP.	MAX.	UNIT
Reference Voltage	V_B		0.51	0.52	0.53	V
Input Bias Current	I_B		—	5	100	nA
Open Loop Gain	A_V		—	90	—	dB
Gain Band width Product	G_B		—	0.6	—	MHz
Maximum Output Voltage (F.B Pin)	V_{OM+}	$R_{NF}=100k\Omega$	$V_{REF}-0.2$	—	—	V
	V_{OM-}	$R_{NF}=100k\Omega$	—	—	200	mV
Output Source Current (F.B Pin)	I_{OM+}	$V_{OM}=1V$	40	85	200	μA

PWM COMPARATE BLOCK

PARAMETER	SYMBOL	RATINGS	MIN.	TYP.	MAX.	UNIT
Input Bias Voltage (F.B Pin)	V_{THO}	duty·cycle=0%	—	0.55	0.65	V
Input Threshold Voltage (F.B Pin)	V_{TH50}	duty·cycle=50%	—	0.87	—	V
Maximum Duty Cycle	αM	F.B Pin=1.2V	55	64	85	%

SOFT START CIRCUIT BLOCK

PARAMETER	SYMBOL	RATINGS	MIN.	TYP.	MAX.	UNIT
Input Bias Current (CS Pin)	I_{BCS}		—	250	650	nA
Input Threshold Voltage (CS Pin)	V_{THCS0}	duty·cycle=0%	—	0.25	0.35	V
Input Threshold Voltage (CS Pin)	V_{THCS50}	duty·cycle=50%	—	0.52	—	V

SHORT CIRCUIT PROTECTION

PARAMETER	SYMBOL	RATINGS	MIN.	TYP.	MAX.	UNIT
Input Threshold Voltage (F.B Pin)	V_{THPC}		1.20	1.50	1.80	V
Charge Current (CS Pin)	I_{CHG}	CS Pin=0V, F.B Pin=2V	10	30	50	μA
Latch mode Threshold Voltage (CS Pin)	V_{THLA}		1.20	1.50	1.80	V

UNDER VOLTAGE LOCKOUT

PARAMETER	SYMBOL	RATINGS	MIN.	TYP.	MAX.	UNIT
ON Threshold Voltage	V_{THON}		—	2.70	—	V
OFF Threshold Voltage	V_{THOFF}		—	2.52	—	V
Hysteresis Voltage	V_{HYS}		60	180	—	mV

6

NJM2368

ELECTRICAL CHARACTERISTICS

($V^+ = 6V$, $R_T = 33k\Omega$, $C_T = 1000pF$, $T_a = 25^\circ C$)

OUTPUT

PARAMETER	SYMBOL	RATINGS	MIN.	TYP.	MAX.	UNIT
H-Output Voltage (OUT Pin)	V_{OH}	$R_L = 10k\Omega$	3.50	4.00	—	V
L-Output Voltage (OUT Pin)	V_{OL}	Output Sink Current = 20mA	—	0.25	0.65	V
Output Source Current (OUT Pin)	I_{SOURCE}	OUT Pin = 0V	8	11	—	mA

GENERAL CHARACTERISTIC

PARAMETER	SYMBOL	RATINGS	MIN.	TYP.	MAX.	UNIT
Quiescent Current	I_{CCLA}	Latch	—	1.6	2.2	mA
Average Quiescent Current	I_{CCAV}	$R_L = \infty$, duty cycle = 50%	—	3.5	4.8	mA

APPLICATION



■ TYPICAL CHARACTERISTICS

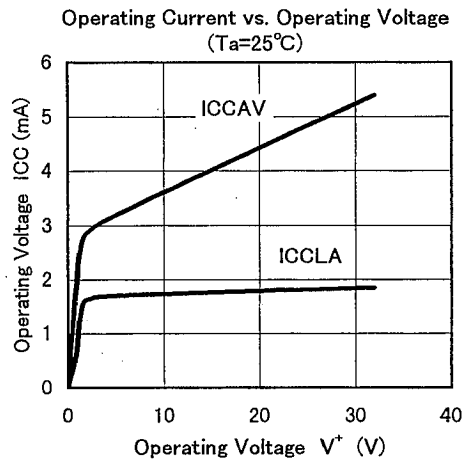
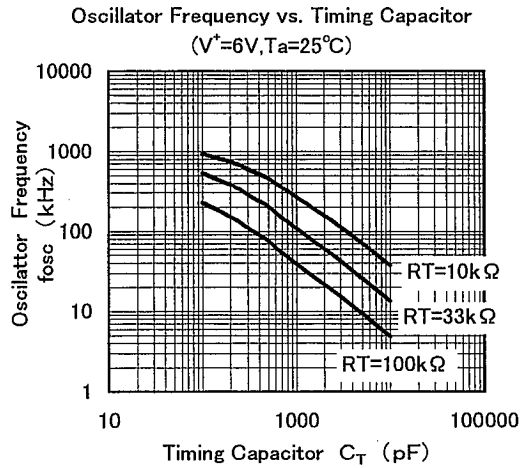

TYPICAL CHARACTERISTICS

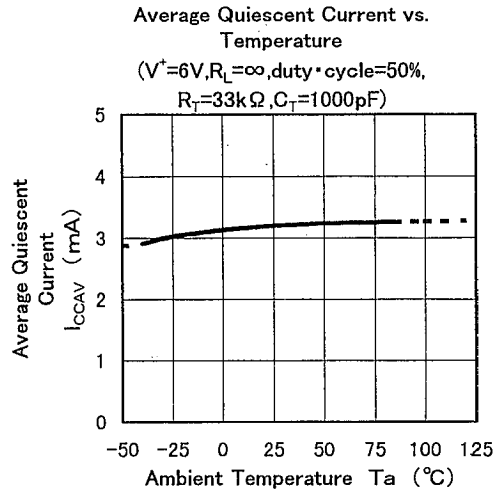
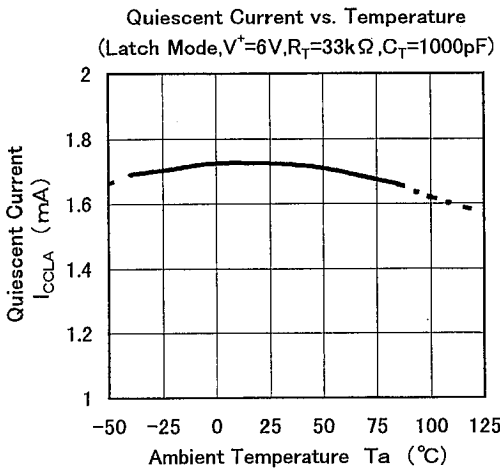
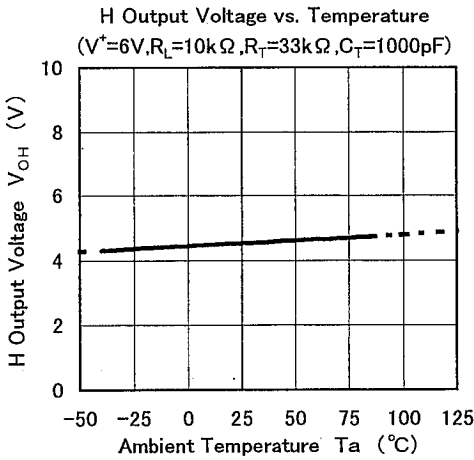
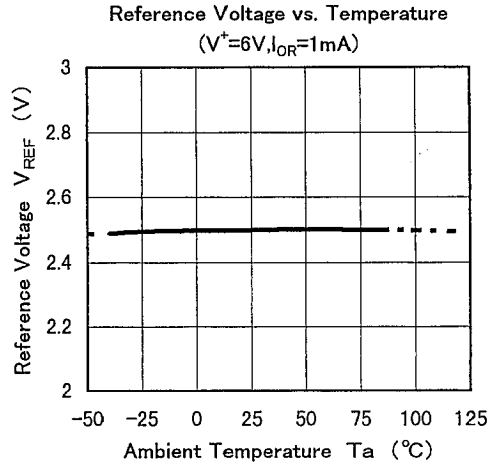
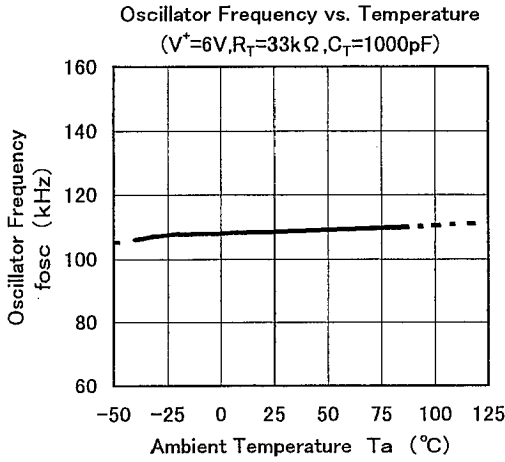

■ TYPICAL CHARACTERISTICS



MEMO

[CAUTION]

The specifications on this databook are only given for information, without any guarantee as regards either mistakes or omissions. The application circuits in this databook are described only to show representative usages of the product and not intended for the guarantee or permission of any right including the industrial rights.

Данный компонент на территории Российской Федерации

Вы можете приобрести в компании MosChip.

Для оперативного оформления запроса Вам необходимо перейти по данной ссылке:

<http://moschip.ru/get-element>

Вы можете разместить у нас заказ для любого Вашего проекта, будь то серийное производство или разработка единичного прибора.

В нашем ассортименте представлены ведущие мировые производители активных и пассивных электронных компонентов.

Нашей специализацией является поставка электронной компонентной базы двойного назначения, продукции таких производителей как XILINX, Intel (ex.ALTERA), Vicor, Microchip, Texas Instruments, Analog Devices, Mini-Circuits, Amphenol, Glenair.

Сотрудничество с глобальными дистрибьюторами электронных компонентов, предоставляет возможность заказывать и получать с международных складов практически любой перечень компонентов в оптимальные для Вас сроки.

На всех этапах разработки и производства наши партнеры могут получить квалифицированную поддержку опытных инженеров.

Система менеджмента качества компании отвечает требованиям в соответствии с ГОСТ Р ИСО 9001, ГОСТ РВ 0015-002 и ЭС РД 009

Офис по работе с юридическими лицами:

105318, г.Москва, ул.Щербаковская д.3, офис 1107, 1118, ДЦ «Щербаковский»

Телефон: +7 495 668-12-70 (многоканальный)

Факс: +7 495 668-12-70 (доб.304)

E-mail: info@moschip.ru

Skype отдела продаж:

moschip.ru

moschip.ru_4

moschip.ru_6

moschip.ru_9