

32 – 45 GHz Wide Band Driver Amplifier

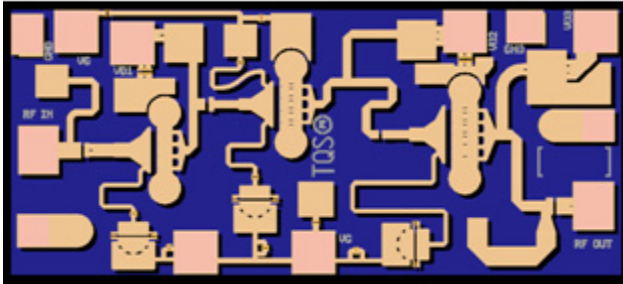

Key Features

- Frequency Range: 32 - 45 GHz
- 25 dBm Nominal Psat @ 38 GHz
- 24 dBm P1dB @ 38 GHz
- 16 dB Nominal Gain @ 38 GHz
- 33 dBm OTOI @ 16dB/Tone
- Bias: 6 V @ 175 mA Idq
- 0.15 um 3MI pHEMT Technology
- Chip Dimensions 1.60 x 0.75 x 0.10 mm (0.063 x 0.030 x 0.004 in)

Measured Fixtured Data

Bias Conditions: Vd = 6 V, Idq = 175 mA

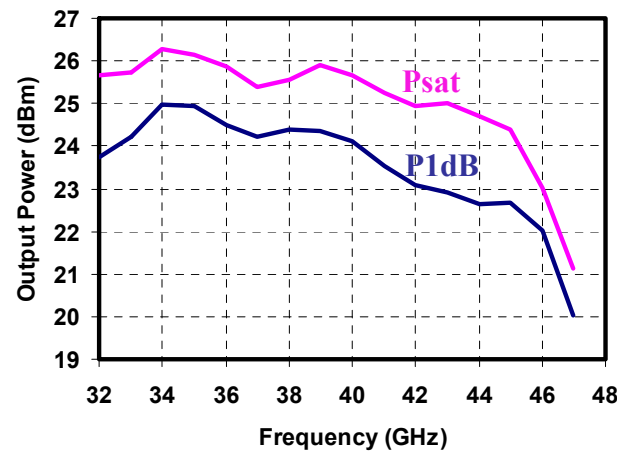
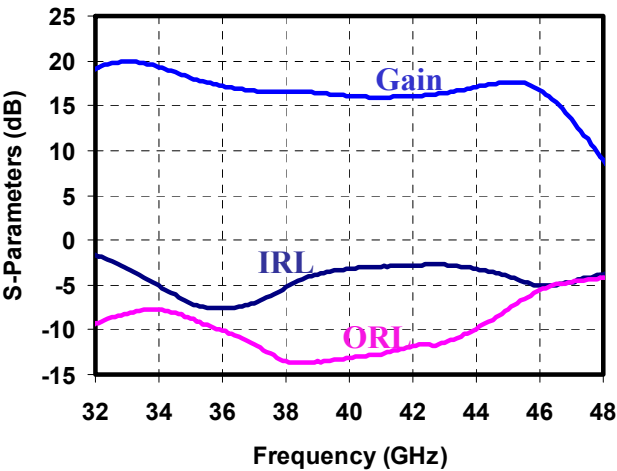

Primary Applications

- Digital Radio
- Point-to-Point Radio
- Point-to-Multipoint Communications
- Military SAT-COM

Product Description

The TriQuint TGA4521 is a compact Driver Amplifier MMIC for Ka-band and Q-band applications. The part is designed using TriQuint's 0.15um power pHEMT production process.

The TGA4521 nominally provides 25 dBm saturated output power, and 24 dBm output power at 1dB Gain compression @ 38 GHz. It also has typical gain of 16 dB.

The part is ideally suited for low cost emerging markets such as Digital Radio, Point-to-Point Radio and Point-to-Multi Point Communications.

The TGA4521 is 100% DC and RF tested on-wafer to ensure performance compliance.

Lead-Free & RoHS compliant.

Evaluation boards are available upon request.

**TABLE I
 MAXIMUM RATINGS 1/**

SYMBOL	PARAMETER	VALUE	NOTES
V _d	Drain Voltage	6.5 V	<u>2/</u>
V _g	Gate Voltage Range	-2 TO 0 V	
I _d	Drain Current	350 mA	<u>2/ 3/</u>
I _g	Gate Current	9 mA	<u>3/</u>
P _{IN}	Input Continuous Wave Power	20 dBm	
P _D	Power Dissipation	See note <u>4/</u>	<u>2/</u>
T _{CH}	Operating Channel Temperature	150 °C	<u>5/ 6/</u>
T _M	Mounting Temperature (30 Seconds)	320 °C	
T _{STG}	Storage Temperature	-65 to 150 °C	

- 1/ These ratings represent the maximum operable values for this device.
- 2/ Combinations of supply voltage, supply current, input power, and output power shall not exceed P_D
- 3/ Total current for the entire MMIC.
- 4/ For a median life time of 1E+6 hrs, Power dissipation is limited to:

$$P_D(\text{max}) = (150\text{ }^{\circ}\text{C} - T_{\text{BASE}}\text{ }^{\circ}\text{C}) / 70\text{ }(^{\circ}\text{C}/\text{W})$$

Where T_{BASE} is the base plate temperature.

- 5/ Junction operating temperature will directly affect the device median time to failure (MTTF). For maximum life, it is recommended that junction temperatures be maintained at the lowest possible levels.
- 6/ These ratings apply to each individual FET.

TABLE II
ELECTRICAL CHARACTERISTICS
 (Ta = 25 °C Nominal)

PARAMETER	FREQUENCY (GHz)	MIN	TYPICAL	UNITS
Frequency Range			32 - 45	GHz
Drain Voltage, Vd			6.0	V
Drain Current, Id			175	mA
Gate Voltage, Vg			-0.7	V
Small Signal Gain, S21	32	14.5	20	dB
	36 - 38	15.5	17	
	44	14	17	
Input Return Loss, S11	32	1	1.5	dB
	36	3.5	8	
	38	2.5	5	
	44	2	3	
Output Return Loss, S22	32 - 38	8	10	dB
	44	4	10	
Output Power @ 1dB Gain Compression, P1dB	38	24	24.5	dBm
	32 - 45		23.5	
Saturated Power, Psat			25	dBm
OTOI @ Pin = 1dBm	38	31	33	dBm
	32 - 45		33	

TABLE III
THERMAL INFORMATION

PARAMETER	TEST CONDITIONS	T _{CH} (°C)	R _{θJC} (°C/W)	T _M (HRS)
R _{θJC} Thermal Resistance (channel to Case)	Vd = 6 V Id = 175 mA Pdiss = 1.05 W	144	70	2.0E+6

Note: Assumes eutectic attach using 1.5 mil 80/20 AuSn mounted to a 20 mil CuMo Carrier at 70 °C baseplate temperature. Worst case condition with no RF applied, 100% of DC power is dissipated.

Measured Data

Bias Conditions: $V_d = 6\text{ V}$, $I_{dq} = 175\text{ mA}$

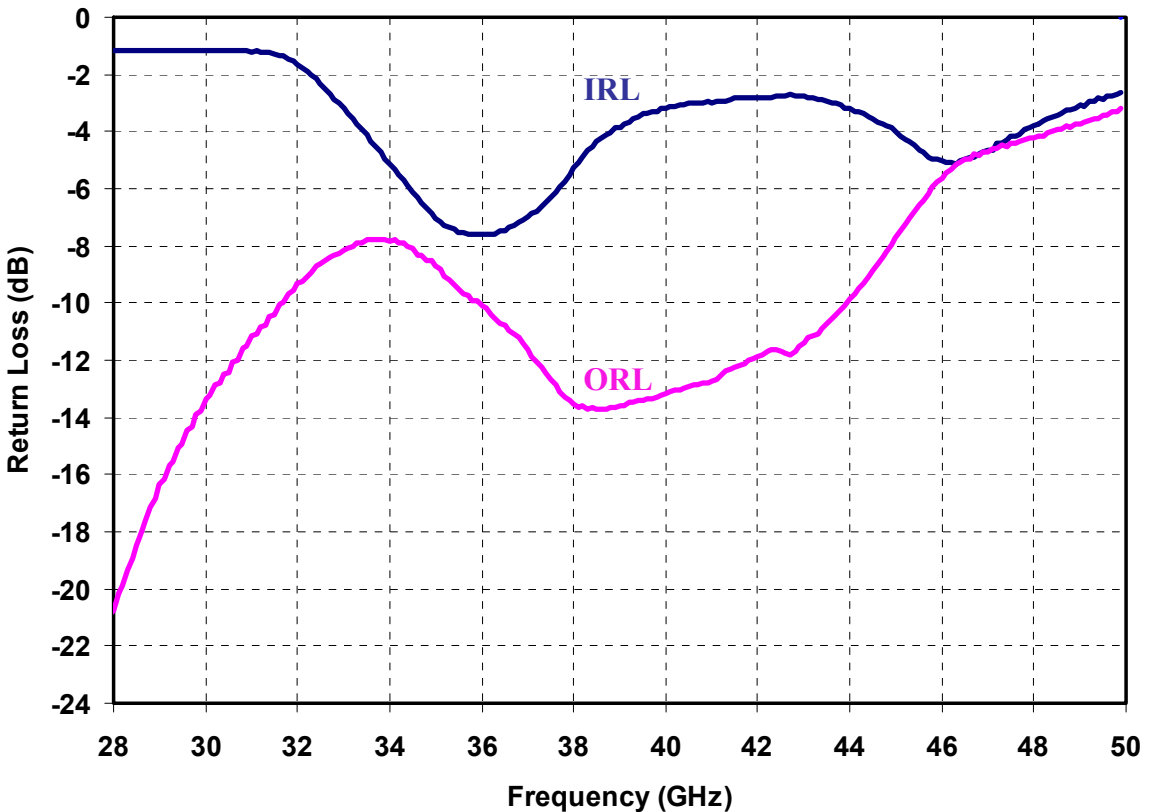
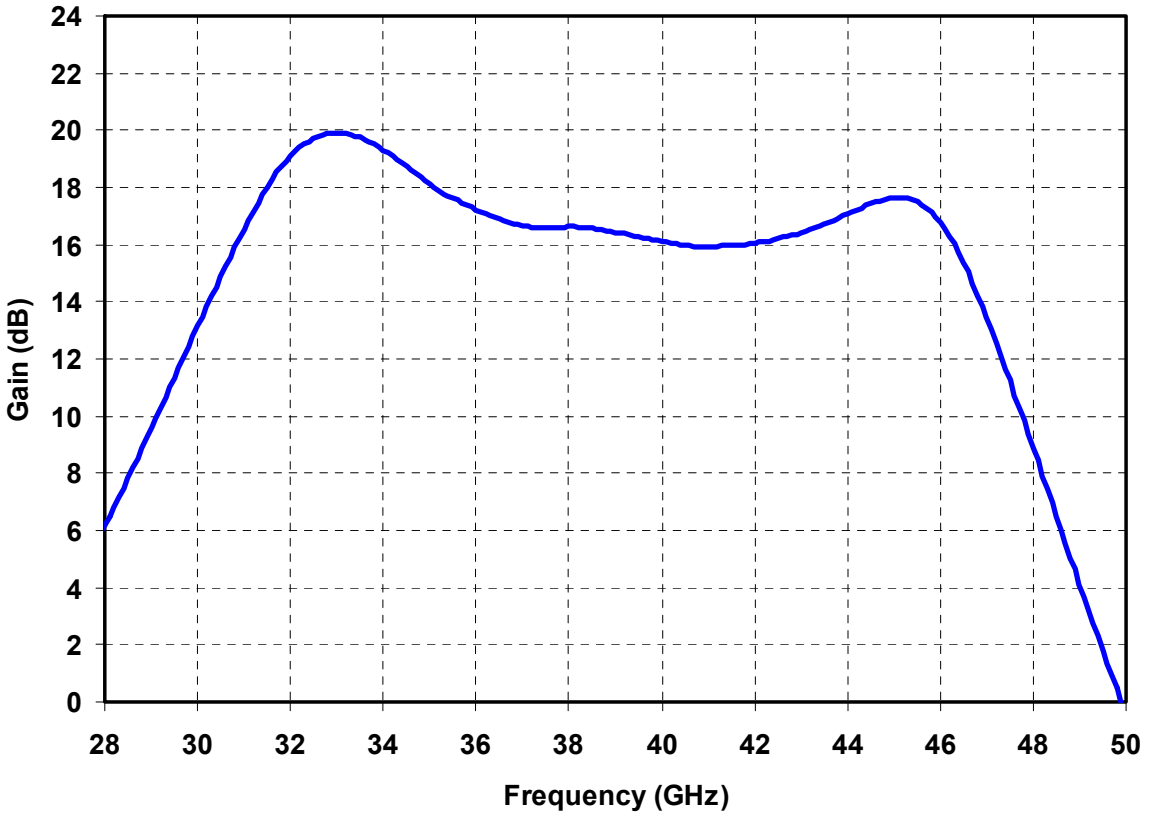

Measured Data

Bias Conditions: $V_d = 6\text{ V}$, $I_{dq} = 175\text{ mA}$

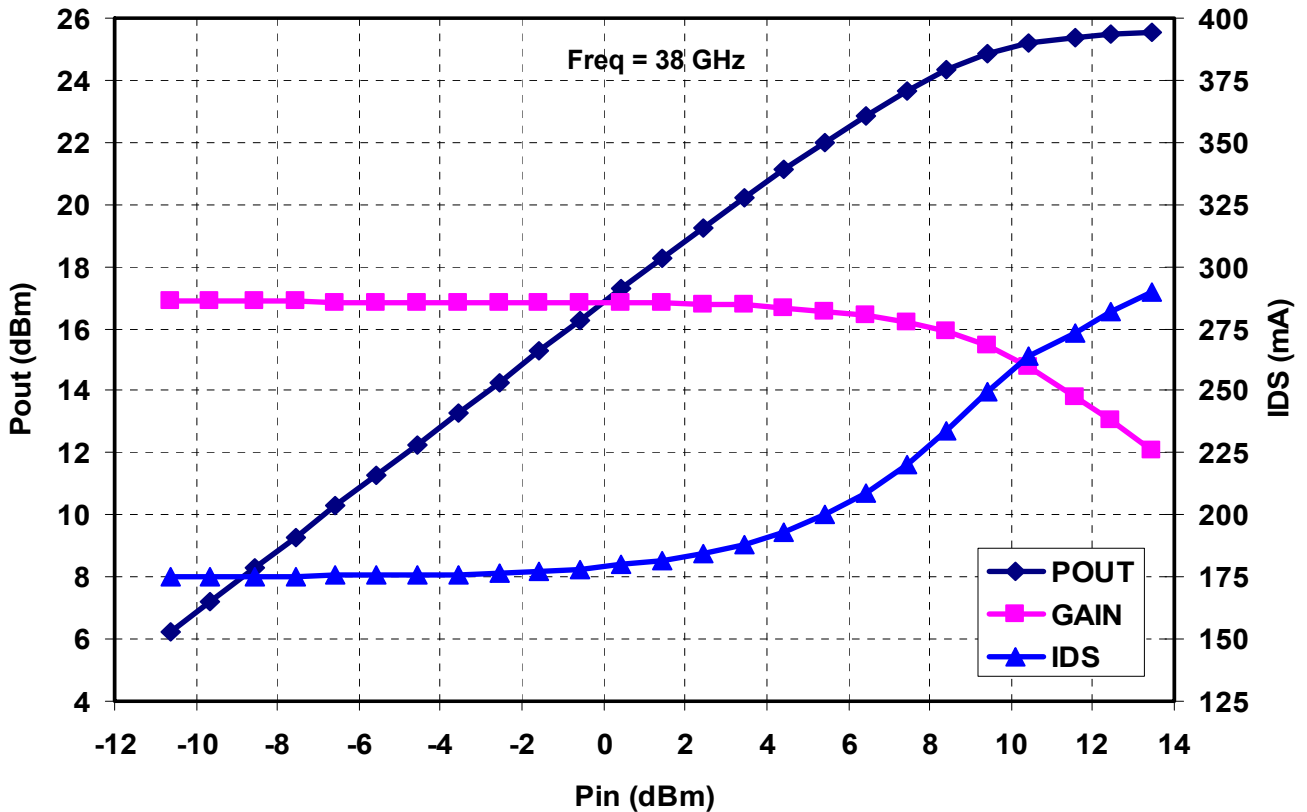
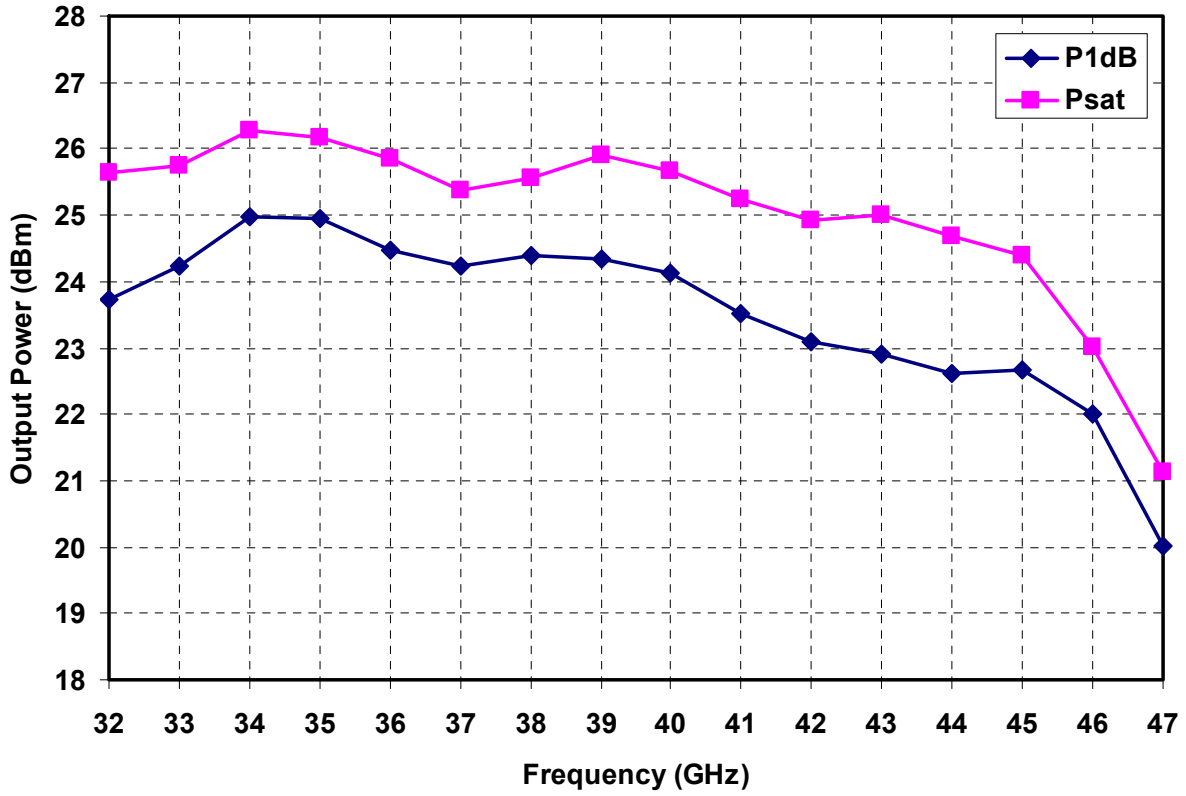

Measured Data

Bias Conditions: $V_d = 6\text{ V}$, $I_{dq} = 175\text{ mA}$, $\Delta f = 10\text{ MHz}$

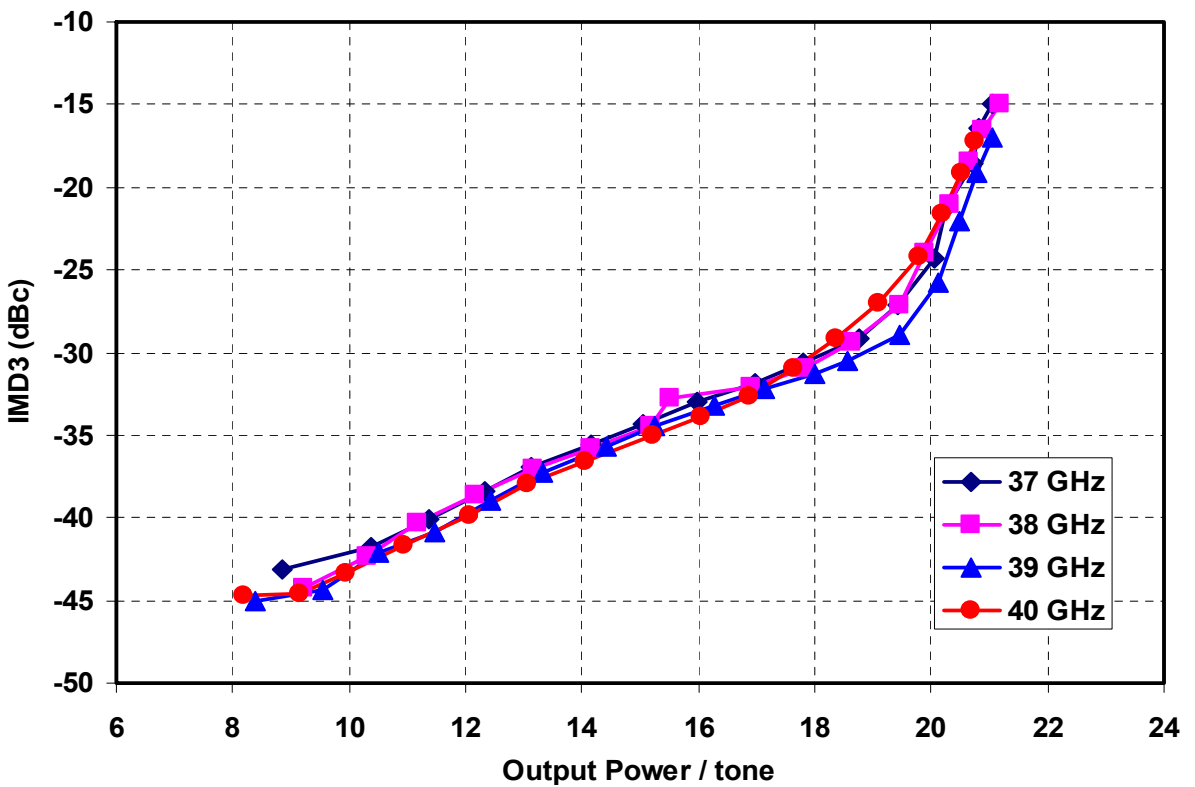
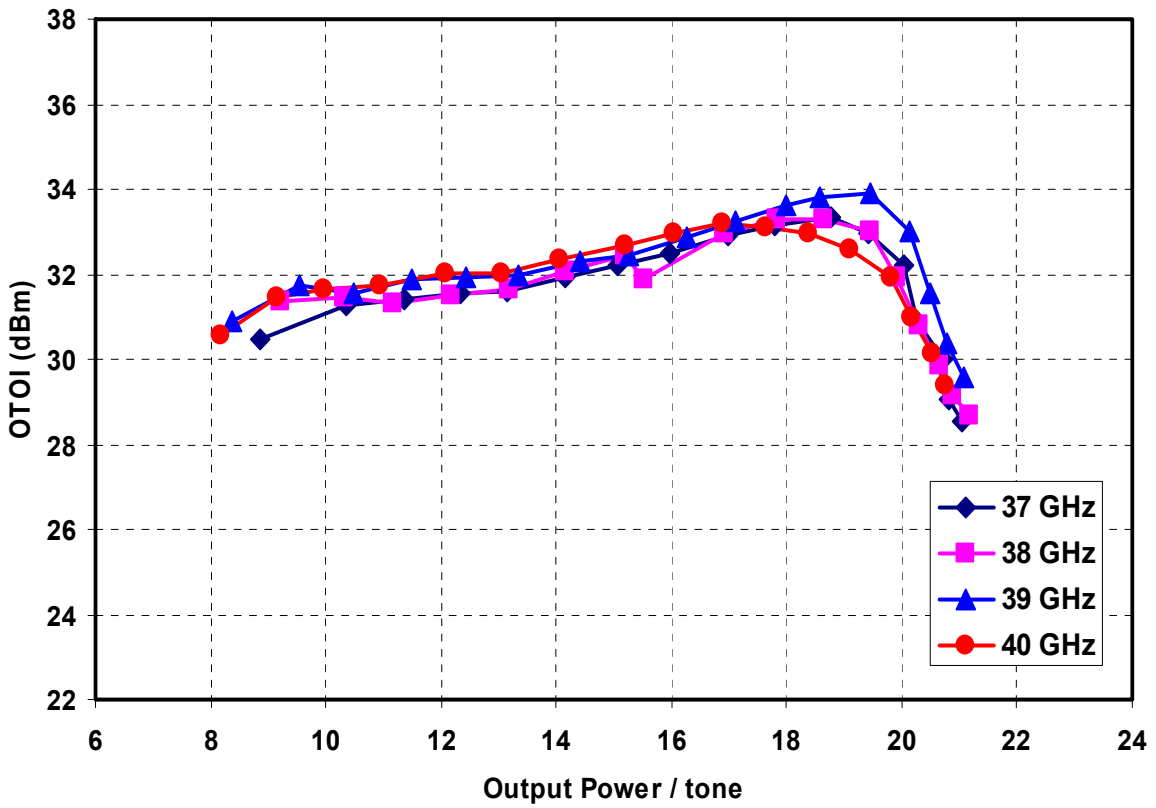

Mechanical Drawing

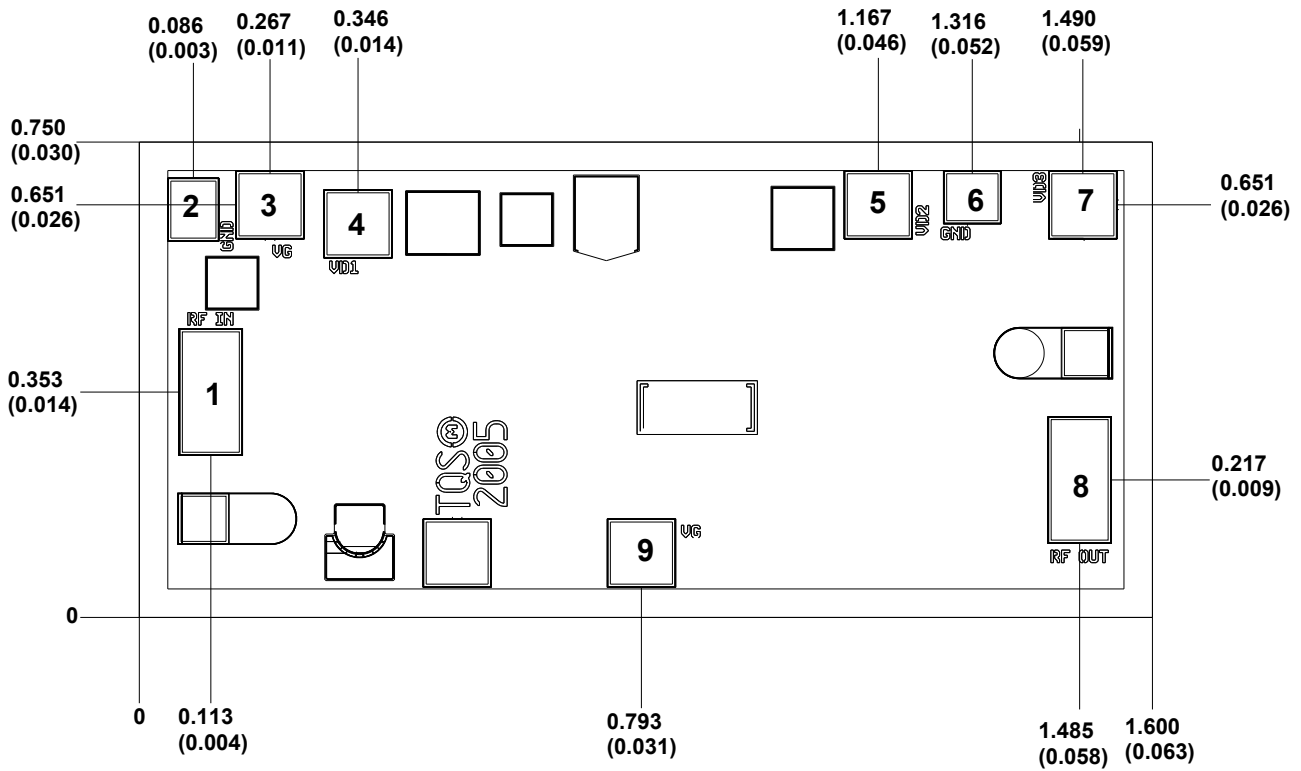

Units: millimeters (inches)

Thickness: 0.100 (0.004)

Chip edge to bond pad dimensions are shown to center of bond pad

Chip size tolerance: +/- 0.051 (0.002)

GND is back side of MMIC

Bond pad #1	(RF In)	0.100 x 0.200	(0.004 x 0.008)
Bond pad #2	(N/C)	0.081 x 0.100	(0.003 x 0.004)
Bond pad #3, 9	(Vg)	0.108 x 0.108	(0.004 x 0.004)
Bond pad #4, 5, 7	(Vd)	0.108 x 0.108	(0.004 x 0.004)
Bond pad #6	(N/C)	0.091 x 0.084	(0.004 x 0.003)
Bond pad #8	(RF Out)	0.100 x 0.200	(0.004 x 0.008)

GaAs MMIC devices are susceptible to damage from Electrostatic Discharge. Proper precautions should be observed during handling, assembly and test.

Recommended Chip Assembly Diagram

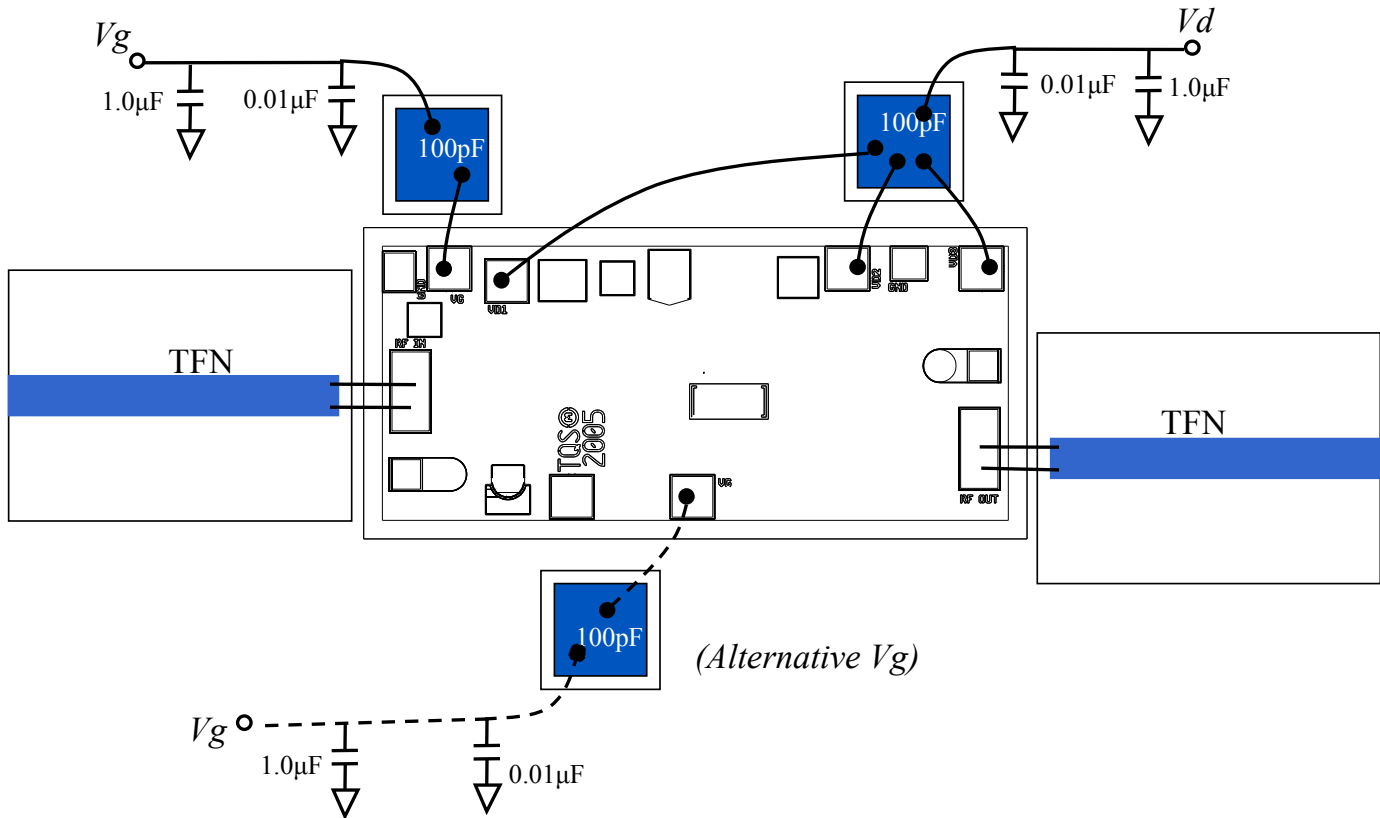

**Bias Conditions: $V_d = 6\text{ V}$
 $V_g = \sim -0.7\text{ V}$ to get 175mA I_d**

GaAs MMIC devices are susceptible to damage from Electrostatic Discharge. Proper precautions should be observed during handling, assembly and test.

Assembly Process Notes

Component placement and adhesive attachment assembly notes:

- Vacuum pencils and/or vacuum collets are the preferred method of pick up.
- Air bridges must be avoided during placement.
- The force impact is critical during auto placement.
- Organic attachment (i.e. epoxy) can be used in low-power applications.
- Curing should be done in a convection oven; proper exhaust is a safety concern.

Reflow process assembly notes:

- Use AuSn (80/20) solder and limit exposure to temperatures above 300°C to 3-4 minutes, maximum.
- An alloy station or conveyor furnace with reducing atmosphere should be used.
- Do not use any kind of flux.
- Coefficient of thermal expansion matching is critical for long-term reliability.
- Devices must be stored in a dry nitrogen atmosphere.

Interconnect process assembly notes:

- Ball bonding is the preferred interconnect technique, except where noted on the assembly diagram.
- Force, time, and ultrasonics are critical bonding parameters.
- Aluminum wire should not be used.
- Devices with small pad sizes should be bonded with 0.0007-inch wire.

Ordering Information

Part	Package Style
TGA4521	GaAs MMIC Die

GaAs MMIC devices are susceptible to damage from Electrostatic Discharge. Proper precautions should be observed during handling, assembly and test.

Данный компонент на территории Российской Федерации

Вы можете приобрести в компании MosChip.

Для оперативного оформления запроса Вам необходимо перейти по данной ссылке:

<http://moschip.ru/get-element>

Вы можете разместить у нас заказ для любого Вашего проекта, будь то серийное производство или разработка единичного прибора.

В нашем ассортименте представлены ведущие мировые производители активных и пассивных электронных компонентов.

Нашей специализацией является поставка электронной компонентной базы двойного назначения, продукции таких производителей как XILINX, Intel (ex.ALTERA), Vicor, Microchip, Texas Instruments, Analog Devices, Mini-Circuits, Amphenol, Glenair.

Сотрудничество с глобальными дистрибьюторами электронных компонентов, предоставляет возможность заказывать и получать с международных складов практически любой перечень компонентов в оптимальные для Вас сроки.

На всех этапах разработки и производства наши партнеры могут получить квалифицированную поддержку опытных инженеров.

Система менеджмента качества компании отвечает требованиям в соответствии с ГОСТ Р ИСО 9001, ГОСТ РВ 0015-002 и ЭС РД 009

Офис по работе с юридическими лицами:

105318, г.Москва, ул.Щербаковская д.3, офис 1107, 1118, ДЦ «Щербаковский»

Телефон: +7 495 668-12-70 (многоканальный)

Факс: +7 495 668-12-70 (доб.304)

E-mail: info@moschip.ru

Skype отдела продаж:

moschip.ru

moschip.ru_4

moschip.ru_6

moschip.ru_9