

## VERONICA-SQ-MINI-O

~15° + 50° oval beam

### TECHNICAL SPECIFICATIONS:

Dimensions	13.9 mm
Height	8.9 mm
Fastening	tape, pin
ROHS compliant	yes 

### MATERIAL SPECIFICATIONS:

Component	Type	Material	Colour	Finish
VERONICA-SQ-MINI-O	Single lens	PMMA	clear	
VERONICA-SQ-MINI-TAPE	Tape	Acrylic foam	clear	



### ORDERING INFORMATION:

Component	Type	Qty in box	MOQ	MPQ	Box weight (kg)
CA14602_VERONICA-SQ-MINI-O » Box size: 480 x 280 x 300 mm	Single lens	5544	252	252	7.8

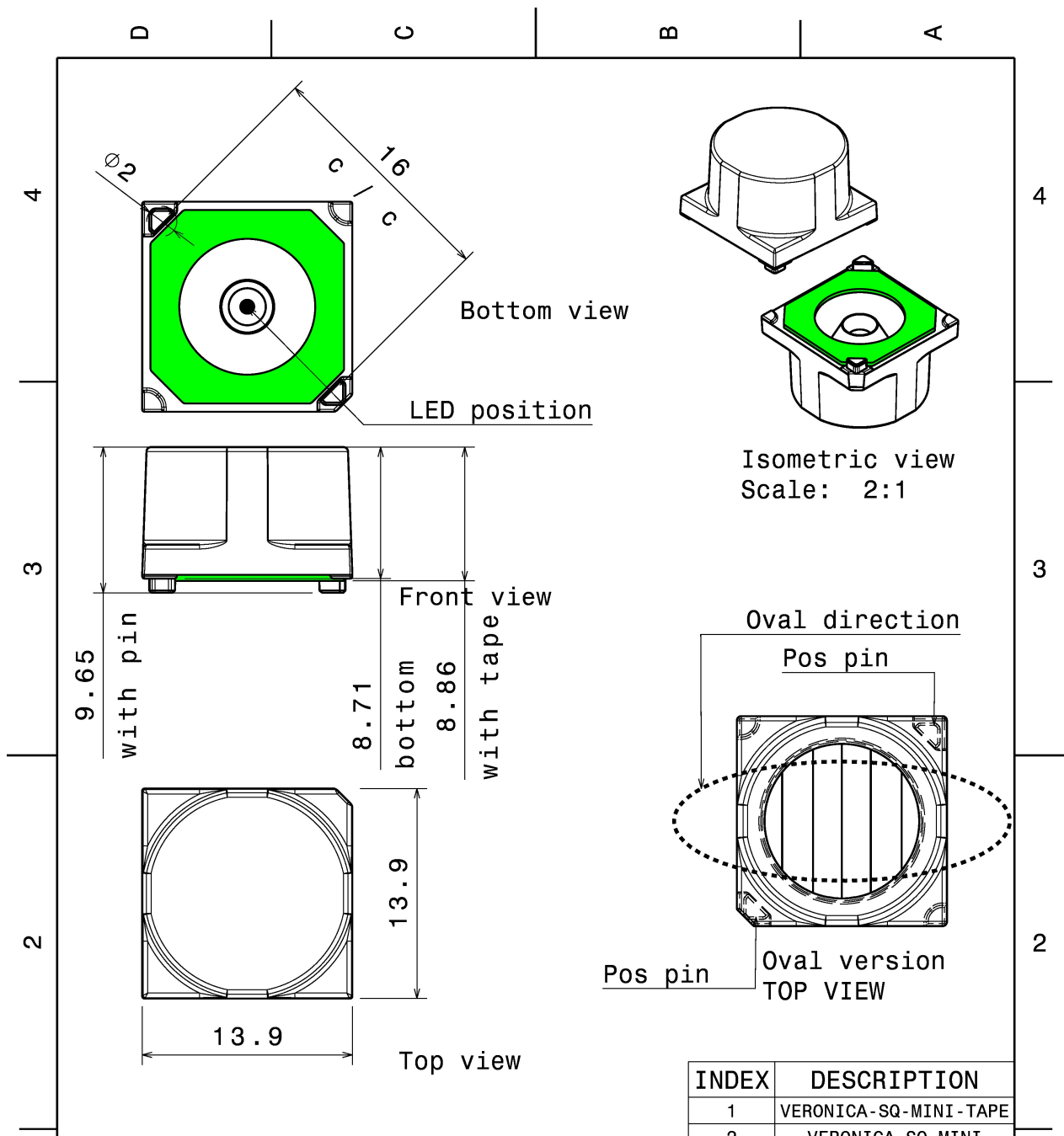

Tolerances if not otherwise shown  
 According to DIN ISO 2768-1  
 Linear measures:  
 up to 30mm class M, otherwise class C  
 According to DIN ISO 2768-2  
 Form and position: class L

**LEDiL** Ledil Oy  
 Joensuunkatu 13  
 FIN 24100 SALO  
 Finland

THIRD ANGLE PROJECTION:

DRAWING TITLE  
**VERONICA-SQ-MINI**

This drawing is the property of LEDiL Oy. It may not be reproduced, copied or communicated without a written agreement with LEDiL Oy.

SIZE	PART NUMBER
A4	-

SCALE	3:1	WEIGHT		SHEET	1/1
-------	-----	--------	--	-------	-----

#### PHOTOMETRIC DATA (MEASURED):

#### CREE

LED XD16  
 FWHM 41.0 + 18.0°  
 Efficiency 89 %  
 Peak intensity 2.2 cd/lm  
 LEDs/each optic 1  
 Light colour White  
 Required components:

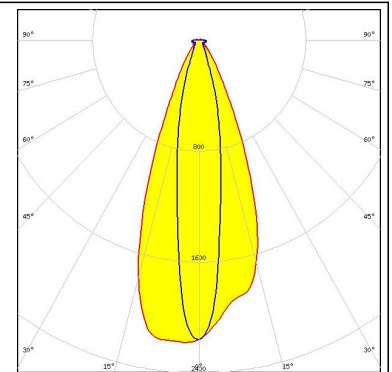

#### CREE

LED XP-E2  
 FWHM 42.0 + 14.0°  
 Efficiency 92 %  
 Peak intensity 3.8 cd/lm  
 LEDs/each optic 1  
 Light colour White  
 Required components:

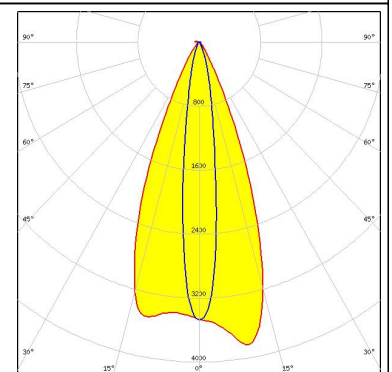
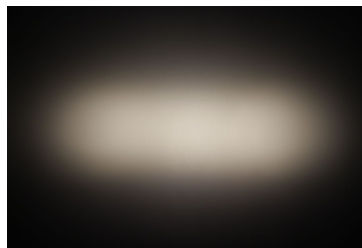

#### CREE

LED XP-G2  
 FWHM 45.0 + 20.0°  
 Efficiency 92 %  
 Peak intensity 2.3 cd/lm  
 LEDs/each optic 1  
 Light colour White  
 Required components:

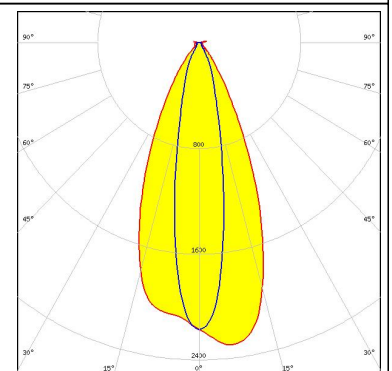
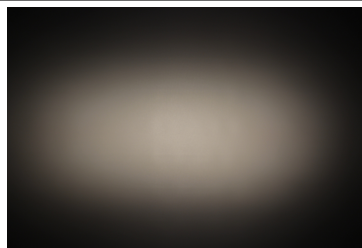

#### CREE

LED XP-G3  
 FWHM 41.0 + 24.0°  
 Efficiency 92 %  
 Peak intensity 1.8 cd/lm  
 LEDs/each optic 1  
 Light colour White  
 Required components:

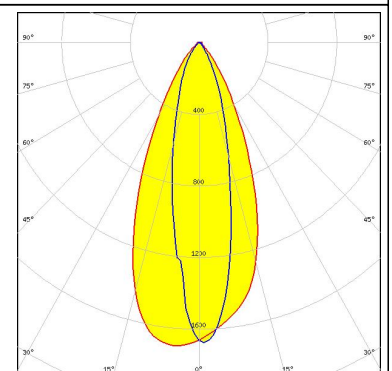
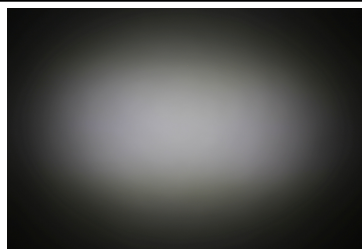

#### PHOTOMETRIC DATA (MEASURED):

##### LUMILEDS

LED LUXEON Rebel  
 FWHM 42.0 + 20.0°  
 Efficiency 90 %  
 Peak intensity 2.1 cd/lm  
 LEDs/each optic 1  
 Light colour White  
 Required components:

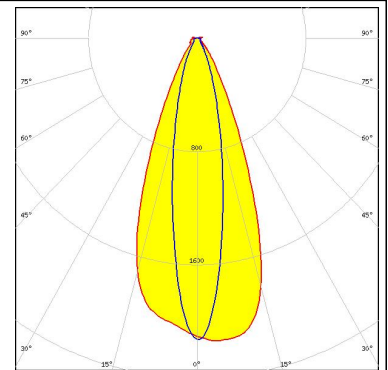

##### LUMILEDS

LED LUXEON Rebel ES  
 FWHM 50.0 + 23.0°  
 Efficiency 80 %  
 Peak intensity 2.1 cd/lm  
 LEDs/each optic 1  
 Light colour White  
 Required components:

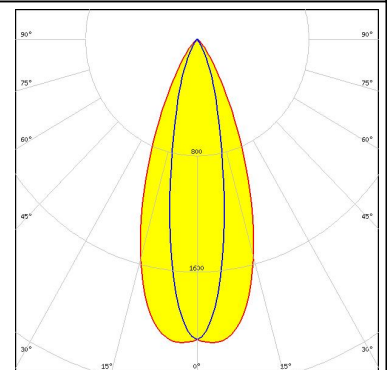
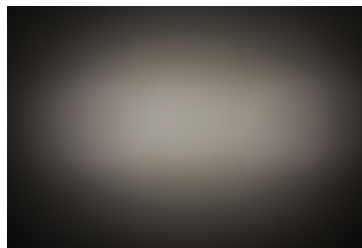

##### LUMILEDS

LED LUXEON TX  
 FWHM 42.0 + 22.0°  
 Efficiency 90 %  
 Peak intensity 2.1 cd/lm  
 LEDs/each optic 1  
 Light colour White  
 Required components:

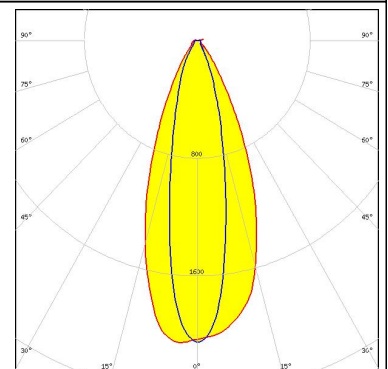
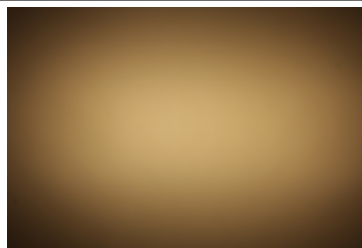

##### NICHIA

LED NCSxE17A  
 FWHM 40.0 + 20.0°  
 Efficiency 89 %  
 Peak intensity 2.1 cd/lm  
 LEDs/each optic 1  
 Light colour White  
 Required components:

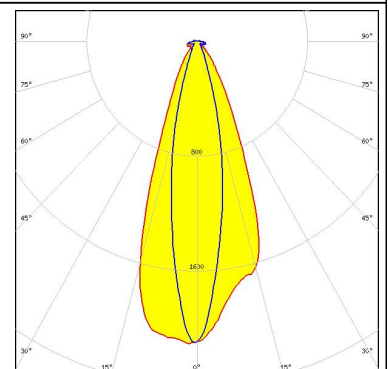
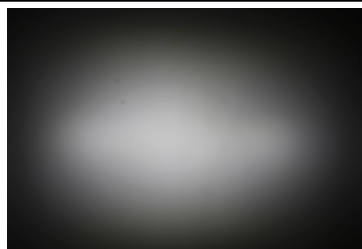

#### PHOTOMETRIC DATA (MEASURED):



**LED** NVSxx19B/NVSxx19C  
**FWHM** 41.0 + 23.0°  
**Efficiency** 90 %  
**Peak intensity** 1.9 cd/lm  
**LEDs/each optic** 1  
**Light colour** White  
**Required components:**

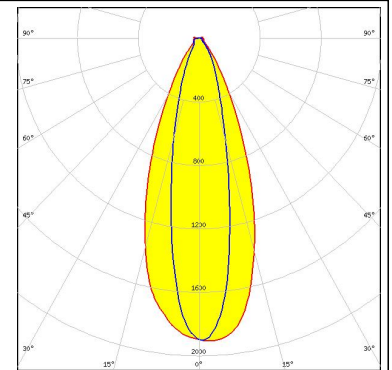

**LED** Duris S5 (2 chip)  
**FWHM** 76.0 + 22.0°  
**Efficiency** 74 %  
**Peak intensity** 1.6 cd/lm  
**LEDs/each optic** 1  
**Light colour** White  
**Required components:**

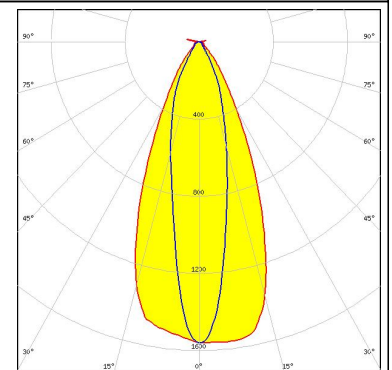
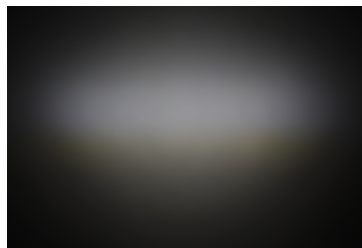

**LED** OSOLON Square EC  
**FWHM** 42.0 + 20.0°  
**Efficiency** 89 %  
**Peak intensity** 2.2 cd/lm  
**LEDs/each optic** 1  
**Light colour** White  
**Required components:**

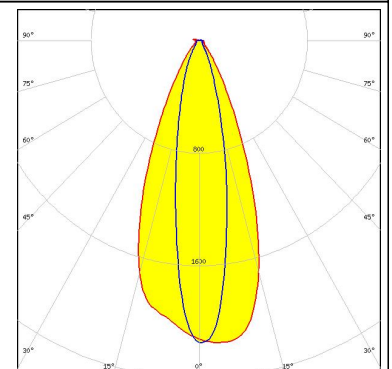
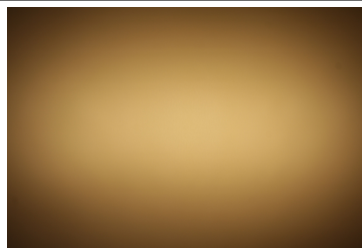

**LED** SFH 4170S  
**FWHM** 40.0 + 12.0°  
**Efficiency** %  
**LEDs/each optic** 1  
**Light colour** IR  
**Required components:**

#### PHOTOMETRIC DATA (MEASURED):

#### OSRAM

Opto Semiconductors

LED SFH 4180S  
 FWHM 38.0 + 11.0°  
 Efficiency %  
 LEDs/each optic 1  
 Light colour IR  
 Required components:

#### SAMSUNG

LED LH181A  
 FWHM 42.0 + 22.0°  
 Efficiency 88 %  
 Peak intensity 1.5 cd/lm  
 LEDs/each optic 1  
 Light colour White  
 Required components:

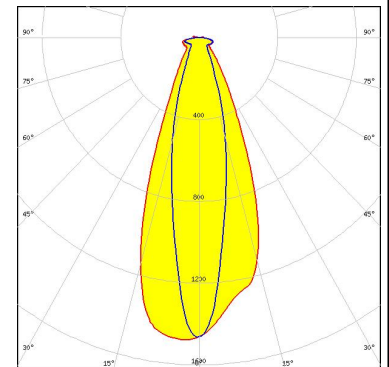
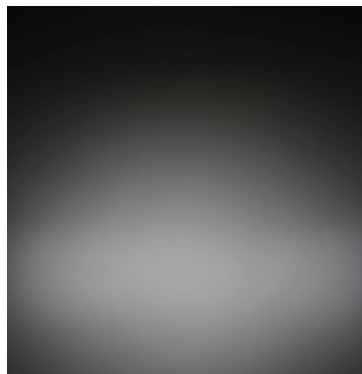

#### SAMSUNG

LED LH181B  
 FWHM 22.0 + 41.0°  
 Efficiency 91 %  
 Peak intensity 1.8 cd/lm  
 LEDs/each optic 1  
 Light colour White  
 Required components:

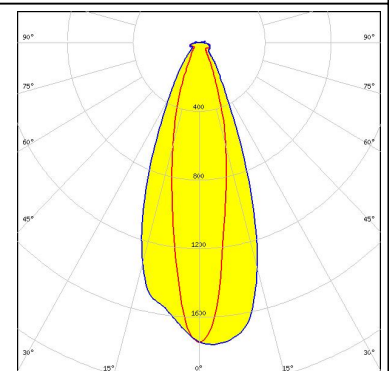
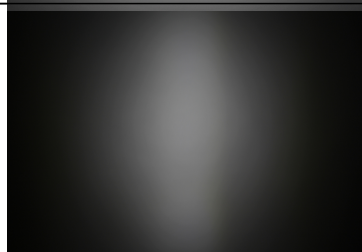

SEOUL SEMICONDUCTOR

LED Z8Y22P  
 FWHM 46.0 + 23.0°  
 Efficiency 90 %  
 Peak intensity 1.5 cd/lm  
 LEDs/each optic 1  
 Light colour White  
 Required components:

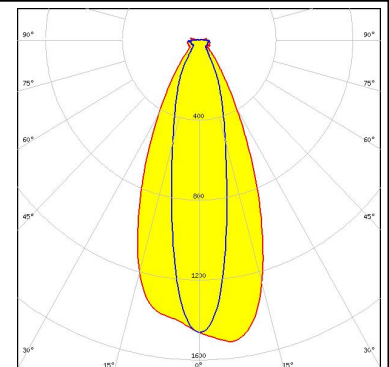
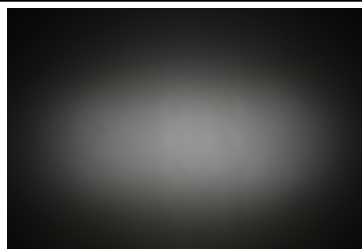

#### PHOTOMETRIC DATA (SIMULATED):



LED XP-G2 HE  
FWHM 50.0 + 26.0°  
Efficiency 90 %  
Peak intensity 1.6 cd/lm  
LEDs/each optic 1  
Light colour White  
Required components:

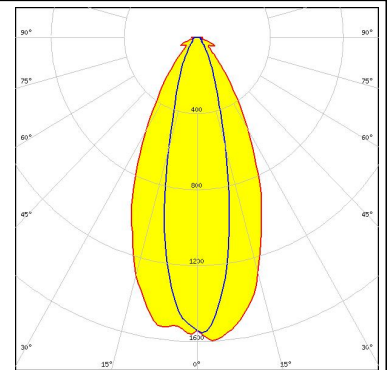

LED XQ-E HD  
FWHM 54.0 + 16.0°  
Efficiency 90 %  
Peak intensity 2.7 cd/lm  
LEDs/each optic 1  
Light colour White  
Required components:



LED LUXEON 5050 Round LES  
FWHM 54.0 + 36.0°  
Efficiency 86 %  
Peak intensity 0.8 cd/lm  
LEDs/each optic 1  
Light colour White  
Required components:

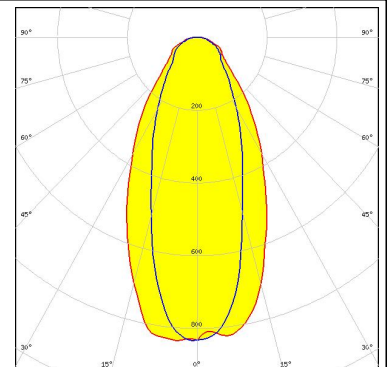

LED LUXEON C  
FWHM 53.0 + 17.0°  
Efficiency 87 %  
Peak intensity 2.6 cd/lm  
LEDs/each optic 1  
Light colour White  
Required components:

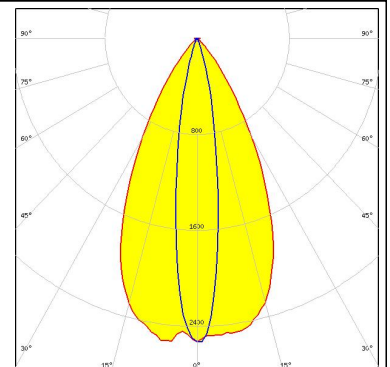

#### PHOTOMETRIC DATA (SIMULATED):

#### LUMILEDS

LED LUXEON CZ  
 FWHM 56.0 + 13.0°  
 Efficiency 91 %  
 Peak intensity 3.3 cd/lm  
 LEDs/each optic 1  
 Light colour PC Amber  
 Required components:

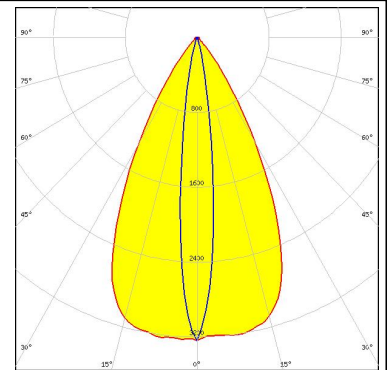

#### LUMILEDS

LED LUXEON CZ  
 FWHM 54.0 + 12.0°  
 Efficiency 91 %  
 Peak intensity 3.5 cd/lm  
 LEDs/each optic 1  
 Light colour Red  
 Required components:

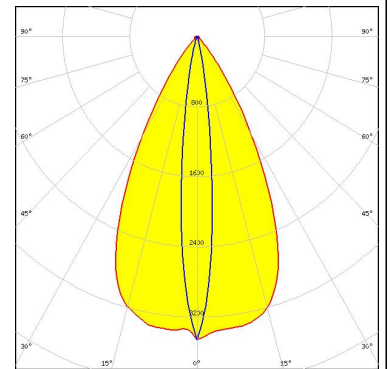

#### LUMILEDS

LED LUXEON Z ES  
 FWHM 53.0 + 16.0°  
 Efficiency 92 %  
 Peak intensity 2.6 cd/lm  
 LEDs/each optic 1  
 Light colour White  
 Required components:

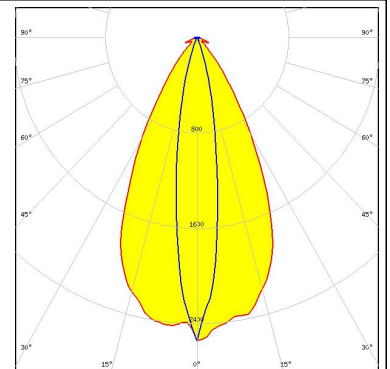

#### OSRAM

OSRAM Opto Semiconductors  
 LED OSCONIQ P 3737 (2W version)  
 FWHM 49.0 + 22.0°  
 Efficiency 83 %  
 Peak intensity 1.9 cd/lm  
 LEDs/each optic 1  
 Light colour White  
 Required components:

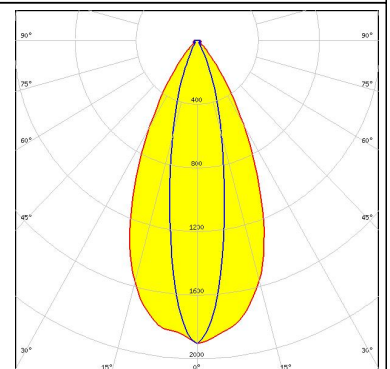



#### PHOTOMETRIC DATA (SIMULATED):

**OSRAM**  
Opto Semiconductors

LED OSCONIQ P 3737 (3W version)  
 FWHM 24.0 + 48.0°  
 Efficiency 84 %  
 Peak intensity 1.3 cd/lm  
 LEDs/each optic 1  
 Light colour White  
 Required components:

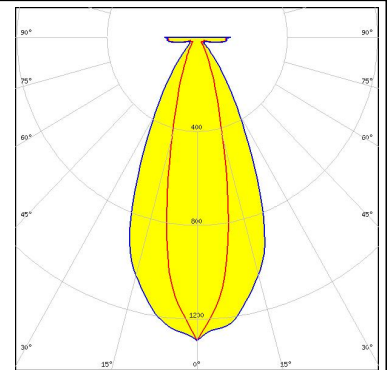

**OSRAM**  
Opto Semiconductors

LED OSLON Square CSSRM2/CSSRM3  
 FWHM 48.0 + 20.0°  
 Efficiency 81 %  
 Peak intensity 2 cd/lm  
 LEDs/each optic 1  
 Light colour White  
 Required components:

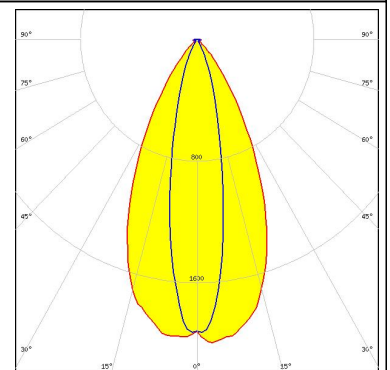

**OSRAM**  
Opto Semiconductors

LED OSLON SSL 150  
 FWHM 55.0 + 16.0°  
 Efficiency 89 %  
 Peak intensity 2.6 cd/lm  
 LEDs/each optic 1  
 Light colour Blue  
 Required components:

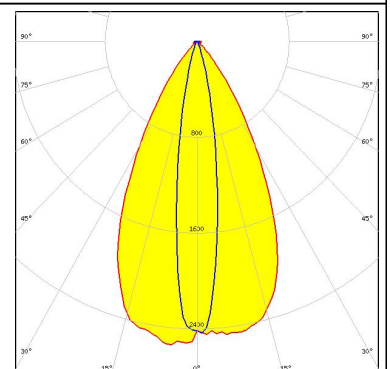

**OSRAM**  
Opto Semiconductors

LED OSLON SSL 150  
 FWHM 54.0 + 15.0°  
 Efficiency 90 %  
 Peak intensity 2.8 cd/lm  
 LEDs/each optic 1  
 Light colour Green  
 Required components:

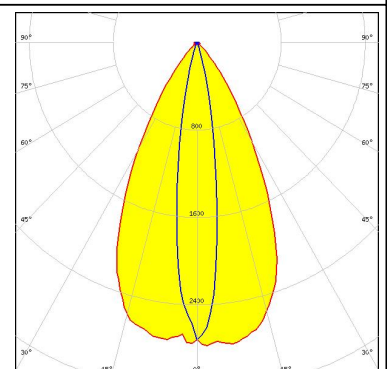

#### PHOTOMETRIC DATA (SIMULATED):

#### OSRAM

Opto Semiconductors

LED OSLOM SSL 150  
 FWHM 53.0 + 16.0°  
 Efficiency 90 %  
 Peak intensity 2.8 cd/lm  
 LEDs/each optic 1  
 Light colour Red  
 Required components:

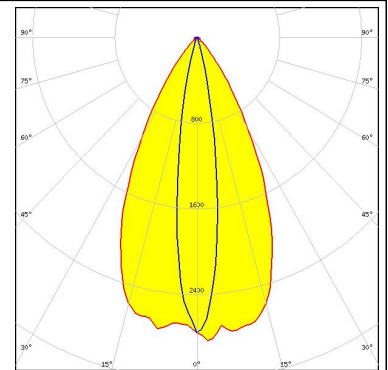

#### SAMSUNG

LED LH351B  
 FWHM 49.0 + 24.0°  
 Efficiency 84 %  
 Peak intensity 1.8 cd/lm  
 LEDs/each optic 1  
 Light colour White  
 Required components:

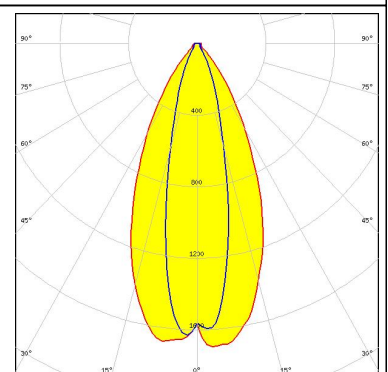

SEOUL SEMICONDUCTOR

LED Z5M1/Z5M2  
 FWHM 50.0 + 22.0°  
 Efficiency 88 %  
 Peak intensity 2 cd/lm  
 LEDs/each optic 1  
 Light colour White  
 Required components:

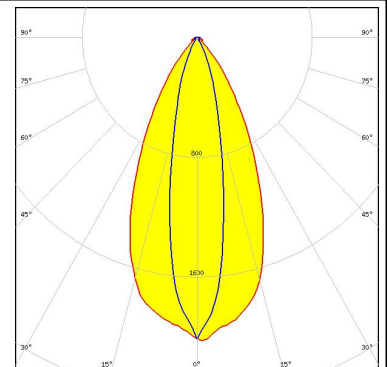

SEOUL SEMICONDUCTOR

LED Z8Y19  
 FWHM 22.0 + 52.0°  
 Efficiency 87 %  
 Peak intensity 1.4 cd/lm  
 LEDs/each optic 1  
 Light colour White  
 Required components:

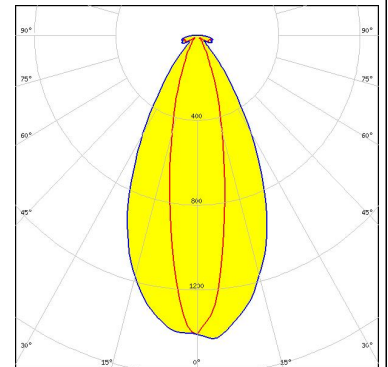

#### PHOTOMETRIC DATA (SIMULATED):



#### GENERAL INFORMATION:

NOTE: The typical beam angle will be changed by different color, chip size and chip position tolerance. The typical total beam angle is the full angle measured where the luminous intensity is half of the peak value.

#### MATERIALS:

As part of our continuous research and improvement processes, and to ensure the best possible quality and availability of our products, LEDiL reserves the right to change material grades without notice.

#### PRODUCT DATA USER AGREEMENT AND DISCLAIMER:

The measured data in the provided downloadable LEDiL Product Datasheets and Mechanical 2D-Drawings is rounded and provided as reference for planning. LEDiL Oy's optical specifications have been verified by conducting performance testing of the products in accordance with the company's quality system. The reported data are averaged results of multiple measurements with typical variation. LEDiL Oy reserves the right to without prior notification make changes and improvements to its products.

LEDiL Oy assumes neither warranty, nor guarantee nor any other liability of any kind for the contents and correctness of the provided data. The provided data has been generated with highest diligence but the provided data may in reality not represent the complete possible variation range of all intrinsic parameters. Therefore, in certain cases a deviation from the provided data could occur.

LEDiL Oy reserves the right to undertake technical changes of its products without further notification which could lead to changes in the provided data. LEDiL Oy assumes no liability of any kind for the possible deviation from any provided data or any other damage resulting from the usage of the provided data.

The user agrees to this disclaimer and user agreement with the download or usage of the provided files.

#### LEDiL Oy

Joensuunkatu 13  
FI-24240 SALO  
Finland

#### LEDiL Inc.

228 West Page Street  
Suite D  
Sycamore IL 60178  
USA

#### Local sales and technical support

[www.ledil.com/  
where\\_to\\_buy](http://www.ledil.com/where_to_buy)

#### Shipping locations

Salo, Finland  
Hong Kong, China

#### Distribution Partners

[www.ledil.com/  
where\\_to\\_buy](http://www.ledil.com/where_to_buy)

## Данный компонент на территории Российской Федерации

### Вы можете приобрести в компании MosChip.

Для оперативного оформления запроса Вам необходимо перейти по данной ссылке:

<http://moschip.ru/get-element>

Вы можете разместить у нас заказ для любого Вашего проекта, будь то серийное производство или разработка единичного прибора.

В нашем ассортименте представлены ведущие мировые производители активных и пассивных электронных компонентов.

Нашей специализацией является поставка электронной компонентной базы двойного назначения, продукции таких производителей как XILINX, Intel (ex.ALTERA), Vicor, Microchip, Texas Instruments, Analog Devices, Mini-Circuits, Amphenol, Glenair.

Сотрудничество с глобальными дистрибьюторами электронных компонентов, предоставляет возможность заказывать и получать с международных складов практически любой перечень компонентов в оптимальные для Вас сроки.

На всех этапах разработки и производства наши партнеры могут получить квалифицированную поддержку опытных инженеров.

Система менеджмента качества компании отвечает требованиям в соответствии с ГОСТ Р ИСО 9001, ГОСТ РВ 0015-002 и ЭС РД 009

### Офис по работе с юридическими лицами:

105318, г.Москва, ул.Щербаковская д.3, офис 1107, 1118, ДЦ «Щербаковский»

Телефон: +7 495 668-12-70 (многоканальный)

Факс: +7 495 668-12-70 (доб.304)

E-mail: [info@moschip.ru](mailto:info@moschip.ru)

Skype отдела продаж:

moschip.ru

moschip.ru\_4

moschip.ru\_6

moschip.ru\_9