

Large Size Ferrite Cores for High Power

T/UU/UI/EC/EIC/EE/EI/DT/PQ/SP series

Issue date: January 2013

- All specifications are subject to change without notice.
 - Conformity to RoHS Directive: This means that, in conformity with EU Directive 2002/95/EC, lead, cadmium, mercury, hexavalent chromium, and specific bromine-based flame retardants, PBB and PBDE, have not been used, except for exempted applications.
-

Large Size Ferrite Cores for High Power

T Series

T CORE

CORE SHAPES AND DIMENSIONS/CHARACTERISTICS



PRODUCT IDENTIFICATION

PE22 T 51 × 13 × 31
 (1) (2) (3) (4) (5)

- (1) Material name
- (2) Shape
- (3) Dimension A
- (4) Dimension C
- (5) Dimension B

Part No.	AL*(nH/N ²) ±25%	Dimensions (mm)			Core factor		A _e (mm ²)	ℓ _e (mm)	V _e (mm ³)	Weight (g)
		øA	øB	C	C ₁ (mm ⁻¹)	C ₂ ×10 ⁻² (mm ⁻³)				
PE22 T51×13×31	2330									80
PC40 T51×13×31	2980	51.0±1.0	31.0±0.6	13.0±0.5	0.97084	0.76235	127	124	15740	80
PE90 T51×13×31	2850									82
PE22 T62×13×39	2290									121
PC40 T62×13×39	2930	62.5±1.2	39.0±0.8	13.5±0.5	0.98689	0.63377	156	154	23930	121
PE90 T62×13×39	2800									124
PE22 T72×20×48	2920									217
PC40 T72×20×48	3730	72.0±1.5	48.0±0.9	20.0±0.5	0.77481	0.32729	237	183	43420	217
PE90 T72×20×48	3570									222
PE22 T80×20×50	3380									294
PC40 T80×20×50	4320	80.0±1.6	50.0±1.0	20.0±0.5	0.66842	0.22694	295	197	57990	294
PE90 T80×20×50	4140									300
PE22 T96×20×70	2270									325
PC40 T96×20×70	2910	96.0±1.9	70.0±1.4	20.0 ±0.5	0.99464	0.38574	258	256	66130	325
PE90 T96×20×70	2780									332
PE22 T104×20×80	1890									333
PC40 T104×20×80	2410	104.0±2.1	80.0±1.6	20.0±0.5	1.19742	0.50179	239	286	68180	333
PE90 T104×20×80	2310									340

* Measuring condition: T=23°C, f=1kHz, H_m=0.4A/m

UU Series

UU CORE

CORE SHAPES AND DIMENSIONS/CHARACTERISTICS



PRODUCT IDENTIFICATION

PE22 UU 79 × 129 × 31
 (1) (2) (3) (4) (5)

- (1) Material name
- (2) Shape
- (3) Dimension A
- (4) Dimension 2B
- (5) Dimension C

Part No.	Al*(nH/N ²) ±25%	Dimensions (mm)								
		A	2B	C	E	2F	H	R ₁	R ₂	E×2F(mm ²)
PE22 UU79×129×31	4790									
PC40 UU79×129×31	6030	79.0±2.5	129.0±2.5	31.5±1.0	34.0min.	85.0±1.5	22.0±1.0	5	22	2980
PE90 UU79×129×31	5768									
PE22 UU100×151×30	5540									
PC40 UU100×151×30	6990	100.0±3.0	151.0±2.5	30.0±1.0	39.0min.	90.0±1.5	30.0±1.5	5	30	3600
PE90 UU100×151×30	6686									
PE22 UU100×160×20	3460									
PC40 UU100×160×20	4360	100.0±3.0	160.0±2.5	20.0±1.0	39.0min.	100.0±1.5	30.0±1.5	5	35	4000
PE90 UU100×160×20	4170									
PE22 UU101×115×25	4480									
PC40 UU101×115×25	5640	101.0±3.0	115.0±2.5	25.4±1.0	50.0min.	64.0±1.5	25.0±1.0	5	25	3260
PE90 UU101×115×25	5395									
PE22 UU120×160×20	3140									
PC40 UU120×160×20	3960	120.0±3.0	160.0±2.5	20.0±1.0	59.0min.	100.0±1.5	30.0±1.5	5	35	6000
PE90 UU120×160×20	3788									
PE22 UU80×150×30N	3570									
PC40 UU80×150×30N	4500	80.0±2.5	150.0±2.5	30.0±1.0	39.0min.	110.0±1.5	20.0±1.0	1	0	4400
PE90 UU80×150×30N	4304									
PE22 UU100×151×30N	5470									
PC40 UU100×151×30N	6900	100.0±3.0	151.0±2.5	30.0±1.0	39.0min.	90.0±1.5	30.0±1.5	1	1	3600
PE90 UU100×151×30N	6600									
PE22 UU101×114×25N	4425									
PC40 UU101×114×25N	5570	101.2±3.0	114.0±2.5	25.4±1.0	49.5min.	63.8±1.5	25.1±1.0	0	0	3254
PE90 UU101×114×25N	5328									

* Measuring condition: T=23°C, f=1kHz, H_m=0.4A/m

Part No.	Core factor					Weight(g)
	$C_1(\text{mm}^{-1})$	$C_2 \times 10^{-2}(\text{mm}^{-3})$	$A_e(\text{mm}^2)$	$l_e(\text{mm})$	$V_e(\text{mm}^3)$	
PE22 UU79×129×31	0.44605	0.06437	693	309	214220	1080
PC40 UU79×129×31						1080
PE90 UU79×129×31						1103
PE22 UU100×151×30	0.38801	0.04241	915	355	324860	1630
PC40 UU100×151×30						1630
PE90 UU100×151×30						1664
PE22 UU100×160×20	0.62375	0.10396	600	374	224550	1130
PC40 UU100×160×20						1130
PE90 UU100×160×20						1154
PE22 UU101×115×25	0.47757	0.07373	648	309	200350	1000
PC40 UU101×115×25						1000
PE90 UU101×115×25						1021
PE22 UU120×160×20	0.69041	0.11507	600	414	248550	1240
PC40 UU120×160×20						1240
PE90 UU120×160×20						1266
PE22 UU80×150×30N	0.60472	0.00101	600	363	217700	1095
PC40 UU80×150×30N						1095
PE90 UU80×150×30N						1118
PE22 UU100×151×30N	0.39361	0.04373	900	354	318820	1642
PC40 UU100×151×30N						1642
PE90 UU100×151×30N						1676
PE22 UU101×114×25N	0.48382	0.07589	638	308	196650	1013
PC40 UU101×114×25N						1013
PE90 UU101×114×25N						1034

UU CORE BAND

BAND SHAPES AND DIMENSIONS/CHARACTERISTICS

AH-type band



Band is optional parts.
AH-type is the band with a board.

B-type band



Band is optional parts.
B-type is the band without a board.



AH type

B type

Part No.	Dimensions (mm)										
	A	B	C	D	E	G	H1	H2	J	t	
FHH 79×129AH	370	27	180	31.5	1.5	7	14	7	160	0.2	
FHH 79×129B	370	27	—	—	—	—	—	—	—	0.3	
FHH 100×151AH	435	27	190	31.5	1.5	7	14	7	170	0.3	
FHH 100×151B	435	30	—	—	—	—	—	—	—	0.3	
FHH 100×160AH	447	18	206	23.0	1.5	7	14	7	186	0.3	
FHH 100×160B	447	18	—	—	—	—	—	—	—	0.3	
FHH 101×115AH	380	23.4	160	28.0	1.5	7	14	7	140	0.3	
FHH 101×115B	378	23.4	—	—	—	—	—	—	—	0.3	
FHH 120×160AH	482	18	206	23.0	1.5	7	14	7	186	0.3	
FHH 120×160B	482	18	—	—	—	—	—	—	—	0.3	

HANDLING INSTRUCTIONS OF UU CORE BAND

When using this product, read and follow the handling instructions below carefully to ensure the safety of the products that you design.

ASSEMBLING

- Certain parts of the ferrite core tightening band (hereinafter referred to as the "band") can be sharp. Be careful when handling these parts.
Use protective equipment such as gloves if necessary.
- When putting a band and ferrite core together, make sure that the ferrite core matches the band's size, and set the ferrite core in the correct position.
- To tighten the band, use a cross point screwdriver of the correct size equipped with a torque reading mechanism.
- The torque for tightening the band must be determined and controlled according to the band's strength, the ferrite core's size, and the usage environment.
- Take special care not to overtighten the band as this could damage the ferrite core and/or the band.
- Conversely, if the tightening torque is too low, you will not be able to secure the ferrite core properly. Take special care to avoid this as this can cause the ferrite core to become displaced, fall off, drop, or affect the ferrite core's characteristics.

USAGE ENVIRONMENT

- Depending on the usage environment, the band may become damaged or its strength may be compromised, reducing the strength at which it can secure the ferrite core.
When using the band, make sure that it is resistant to the intended usage environment.
- The band is constructed in such a way that it can become extended or damaged when subjected to shocks, excessive loads, vibrations, temperature variations, or high and low temperatures, causing the ferrite core to become displaced, fall off, or drop.
Make sure that the strength of the band itself and the strength at which it secures the ferrite core can be maintained in the intended usage environment.
- The band is made of metal, which means it can be affected by water, chemicals and other elements, which may in turn lead to corrosion.
When using the band, make sure that it is resistant to the intended usage environment.

OTHER PRECAUTIONS

- The band is essentially a thin metal plate. Take special care to avoid accidents because its ends can behave like the tip of a whip.
Persons handling the band must take special care to protect themselves as well as others from getting injured.
- Never re-work the band or replace any parts becomes such actions can compromise the band's strength and lead to problems.
- Do not reuse a band that you have used once before as it may not have sufficient strength.
- Do not use the bands for purposes other than to secure ferrite cores.
The bands are not edible. Keep them out of the reach of children.

UU79X129X31



Parameter

Core constant	C1	mm ⁻¹	0.44605
	C2×10 ⁻²	mm ⁻³	0.06437
Effective magnetic path length	ℓ _e	mm	309
Effective cross-sectional area	A _e	mm ²	693
Effective core volume	V _e	mm ³	214220
Minimum cross-sectional area	A _{min.*}	mm ²	693LB*
Winding cross-sectional area	A _{cw}	mm ²	2980
Weight(approx.)		g	1080

* The symbol followed A min. value shows minimum cross-sectional area part. L is outer pole part, B is the back part.

Part No.	AL-value*(nH/N ²)
PE22 UU79X129X31	4790±25%
PC40 UU79X129X31	6030±25%

* AL-value: T=23°C, f=1kHz, H_m=0.4A/m

NI limit vs. AL-value for PE22 UU79X129X31



When applied magnetic field providing NI to a setting core for arbitrary AL-value, show each NI value when decreased 20% and 40% from initial AL-value.

AL-value vs. Air gap length for PE22 UU79X129X31



NI limit vs. AL-value for PC40 UU79X129X31



When applied magnetic field providing NI to a setting core for arbitrary AL-value, show each NI value when decreased 20% and 40% from initial AL-value.

AL-value vs. Air gap length for PC40 UU79X129X31

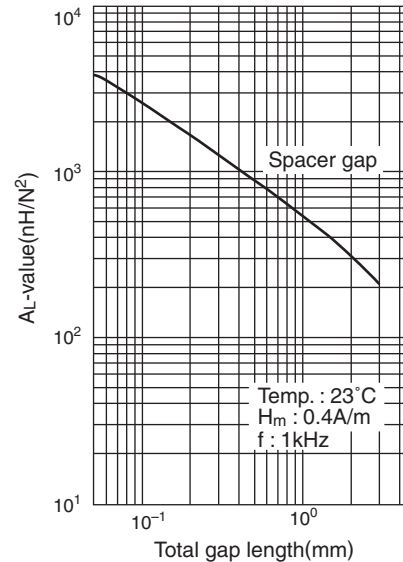

UU100X151X30



Parameter

Core constant	C1	mm ⁻¹	0.38801
	C2×10 ⁻²	mm ⁻³	0.04241
Effective magnetic path length	ℓ _e	mm	355
Effective cross-sectional area	A _e	mm ²	915
Effective core volume	V _e	mm ³	324860
Minimum cross-sectional area	A _{min.*}	mm ²	900L*
Winding cross-sectional area	A _{cw}	mm ²	3600
Weight(approx.)		g	1630

* The symbol followed A min. value shows minimum cross-sectional area part. L is outer pole part, B is the back part.

Part No.	AL-value*(nH/N ²)
PE22 UU100X151X30	5540±25%
PC40 UU100X151X30	6990±25%

* AL-value: T=23°C, f=1kHz, H_m=0.4A/m

NI limit vs. AL-value for PE22 UU100X151X30



When applied magnetic field providing NI to a setting core for arbitrary AL-value, show each NI value when decreased 20% and 40% from initial AL-value.

AL-value vs. Air gap length for PE22 UU100X151X30

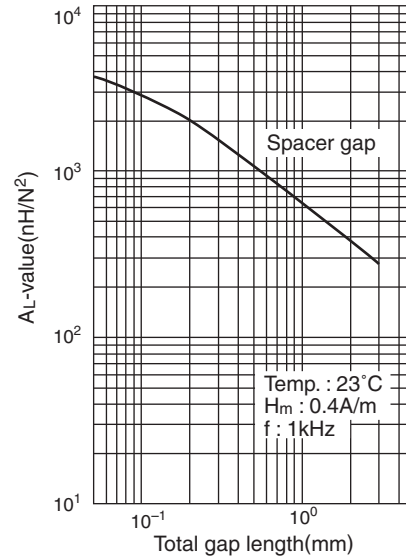

NI limit vs. AL-value for PC40 UU100X151X30



When applied magnetic field providing NI to a setting core for arbitrary AL-value, show each NI value when decreased 20% and 40% from initial AL-value.

AL-value vs. Air gap length for PC40 UU100X151X30



UU100X160X20



Parameter

Core constant	C1	mm ⁻¹	0.62375
	C2×10 ⁻²	mm ⁻³	0.10396
Effective magnetic path length	ℓ _e	mm	374
Effective cross-sectional area	A _e	mm ²	600
Effective core volume	V _e	mm ³	224550
Minimum cross-sectional area	A _{min.*}	mm ²	600LB*
Cross-sectional winding area of core	A _{cw}	mm ²	4000
Weight(approx.)		g	1130

* The symbol followed A min. value shows minimum cross-sectional area part. L is outer pole part, B is the back part.

Part No.	AL-value*(nH/N ²)
PE22 UU100X160X20	3460±25%
PC40 UU100X160X20	4360±25%

* AL-value: T=23°C, f=1kHz, H_m=0.4A/m

NI limit vs. AL-value for PE22 UU100X160X20



AL-value vs. Air gap length for PE22 UU100X160X20



NI limit vs. AL-value for PC40 UU100X160X20



AL-value vs. Air gap length for PC40 UU100X160X20



UU101X115X25

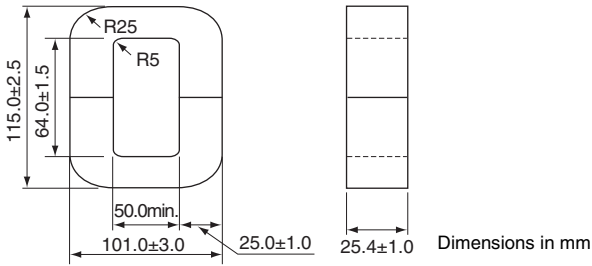

Parameter

Core constant	C1	mm ⁻¹	0.47757
	C2×10 ⁻²	mm ⁻³	0.07373
Effective magnetic path length	ℓ _e	mm	309
Effective cross-sectional area	A _e	mm ²	648
Effective core volume	V _e	mm ³	200350
Minimum cross-sectional area	A _{min.*}	mm ²	635L*
Cross-sectional winding area of core	A _{cw}	mm ²	3260
Weight(approx.)		g	1000

* The symbol followed A min. value shows minimum cross-sectional area part. L is outer pole part, B is the back part.

Part No.	AL-value*(nH/N ²)
PE22 UU101X115X25	4480±25%
PC40 UU101X115X25	5640±25%

* AL-value: T=23°C, f=1kHz, H_m=0.4A/m

NI limit vs. AL-value for PE22 UU101X115X25



When applied magnetic field providing NI to a setting core for arbitrary AL-value, show each NI value when decreased 20% and 40% from initial AL-value.

AL-value vs. Air gap length for PE22 UU101X115X25



Temp. : 23°C
H_m : 0.4A/m
f : 1kHz

NI limit vs. AL-value for PC40 UU101X115X25



When applied magnetic field providing NI to a setting core for arbitrary AL-value, show each NI value when decreased 20% and 40% from initial AL-value.

AL-value vs. Air gap length for PC40 UU101X115X25



Temp. : 23°C
H_m : 0.4A/m
f : 1kHz

UU120X160X20

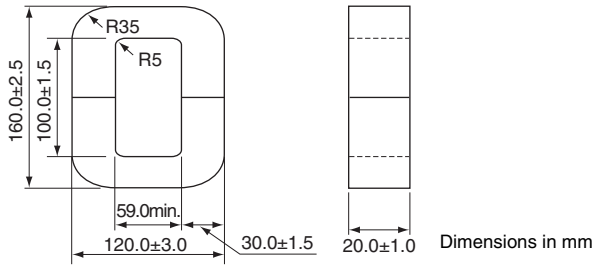

Parameter

Core constant	C1	mm ⁻¹	0.69041
	C2×10 ⁻²	mm ⁻³	0.11507
Effective magnetic path length	ℓ _e	mm	414
Effective cross-sectional area	A _e	mm ²	600
Effective core volume	V _e	mm ³	248550
Minimum cross-sectional area	A _{min.*}	mm ²	600LB*
Cross-sectional winding area of core	A _{cw}	mm ²	6000
Weight(approx.)		g	1240

* The symbol followed A min. value shows minimum cross-sectional area part. L is outer pole part, B is the back part.

Part No.	AL-value*(nH/N ²)
PE22 UU120X160X20	3140±25%
PC40 UU120X160X20	3960±25%

* AL-value: T=23°C, f=1kHz, H_m=0.4A/m

NI limit vs. AL-value for PE22 UU120X160X20



When applied magnetic field providing NI to a setting core for arbitrary AL-value, show each NI value when decreased 20% and 40% from initial AL-value.

AL-value vs. Air gap length for PE22 UU120X160X20



NI limit vs. AL-value for PC40 UU120X160X20



When applied magnetic field providing NI to a setting core for arbitrary AL-value, show each NI value when decreased 20% and 40% from initial AL-value.

AL-value vs. Air gap length for PC40 UU120X160X20



UI Series

UI CORE

CORE SHAPES AND DIMENSIONS/CHARACTERISTICS

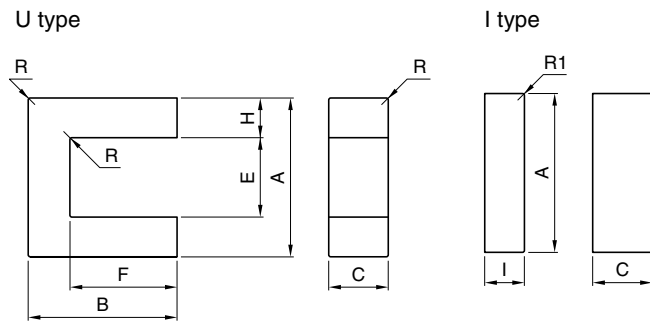

PRODUCT IDENTIFICATION

PE22 UI 80 × 95 × 30 N
(1) (2) (3) (4) (5)

- (1) Material name
- (2) Shape
- (3) Dimension A
- (4) Dimension B+I
- (5) Dimension C

Part No.	AL*(nH/N ²) ±25%	Dimensions (mm)								
		A	B+I	C	E	F	H	I	R	
PE22 UI80×95×30N	5010									
PC40 UI80×95×30N	6280	80.0±1.5	95.0±1.0	30.0±0.5	39.0min.	55.0±0.5	20.0±0.5	20.0±0.5	1.0max.	
PE90 UI80×95×30N	6007									
PE22 UI100×105×30N	7220									
PC40 UI100×105×30N	9065	100.0±1.5	105.0±1.0	30.0±0.5	39.0min.	45.0±0.5	30.0±0.5	30.0±0.5	1.0max.	
PE90 UI100×105×30N	8671									

* Measuring condition: T=23°C, f=1kHz, H_m=0.4A/m

Part No.	Core factor					Weight (g)
	C ₁ (mm ⁻¹)	C ₂ ×10 ⁻² (mm ⁻³)	A _e (mm ²)	ℓ _e (mm)	V _e (mm ³)	
PE22 UI80×95×30N						778
PC40 UI80×95×30N	0.42139	0.07023	600	253	151700	778
PE90 UI80×95×30N						794
PE22 UI100×105×30N						1253
PC40 UI100×105×30N	0.29361	0.03262	900	264	237820	1253
PE90 UI100×105×30N						1279

EC Series

EC CORE

CORE SHAPES AND DIMENSIONS/CHARACTERISTICS



PRODUCT IDENTIFICATION

PE22 EC 90 × 90 × 30
(1) (2) (3) (4) (5)

- (1) Material name
- (2) Shape
- (3) Dimension A
- (4) Dimension B×2
- (5) Dimension C

EC CORE BOBBIN

FOR EC70



Bobbin is optional parts.

FOR EC90, 120



Bobbin is optional parts.

Part No.	AL*(nH/N ²) ±25%	Dimensions (mm)										
		A	B×2	C	øD	øE	F×2	M	J	R	K	K×2F(mm ²)
PE22 EC70×69×16	3910	70.0±1.7	69.0±1.0	16.4±0.5	16.4±0.5	43.3min.	45.5±1.0	5.2	4.75	1max.	14.1	639
PC40 EC70×69×16	4845											
PE90 EC70×69×16	4634											
PE22 EC90×90×30	5925	90.0±1.8	90.0±1.3	30.0±1.0	30.0±1.0	68.5min.	71.0±1.0	5.5	6.0	1max.	20.0	1420
PC40 EC90×90×30	7415											
PE90 EC90×90×30	7093											
PE22 EC120×101×30	6395	120.0±2.0	101.0±1.3	30.0±1.0	30.0±1.0	93.3min.	71.0±1.0	5.5	6.03	1.5max.	32.5	2307
PC40 EC120×101×30	8025											
PE90 EC120×101×30	7676											

* Measuring condition: T=23°C, f=1kHz, H_m=0.4A/m

Part No.	Core factor						Weight (g)
	C ₁ (mm ⁻¹)	C ₂ ×10 ⁻² (mm ⁻³)	A _e (mm ²)	ℓ _e (mm)	V _e (mm ³)		
PE22 EC70×69×16						250	
PC40 EC70×69×16	0.5138891	0.18322	280	144	40420	250	
PE90 EC70×69×16						255	
PE22 EC90×90×30						635	
PC40 EC90×90×30	0.3533380	0.05648	626	221	138270	635	
PE90 EC90×90×30						648	
PE22 EC120×101×30						986	
PC40 EC120×101×30	0.3300745	0.04278	772	255	196490	986	
PE90 EC120×101×30						1007	

EC CORE BOBBIN

Part No.	Dimensions (mm)							Cross-sectional winding area A _w (mm ²)	Average winding length ℓ _w (mm)	Weight (g)	Material
	øA	øB	C	X	Y	Z	t*				
BEC70	42.5±0.5	19.3±0.3	41.5±2.5	70.0±1.5	56.0±1.5	57.0±2.0	1.13	471.4	98	19.0	PBT
BEC90	67.0±0.7	35.0±0.5	65.0±3.0	79.5±0.5	76.0±1.0	89.5±2.5	1.7	1047	162	82.0	PBT

* Bobbin minimum thickness

EC70X69X16

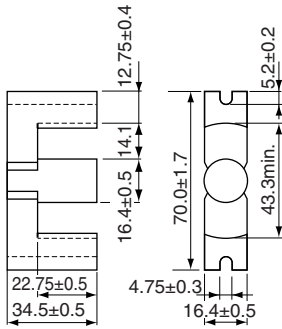

Dimensions in mm

Parameter

Core constant	C1	mm ⁻¹	0.5138891
	C2×10 ⁻²	mm ⁻³	0.18322
Effective magnetic path length	ℓ _e	mm	144
Effective cross-sectional area	A _e	mm ²	280
Effective core volume	V _e	mm ³	40420
Cross-sectional center leg area	A _c	mm ²	211
Minimum cross-sectional area	A _{min.*}	mm ²	211C*
Winding cross-sectional area	A _{cw}	mm ²	642
Weight(approx.)		g	250

* The symbol followed A min. value shows minimum cross-sectional area part. C is center pole part, L is outer pole part, B is the back part.

Part No.	AL-value*(nH/N ²)	Calculated output power(kW) (forward converter mode)
PE22 EC70X69X16	3910±25%	1.1(100kHz)
PC40 EC70X69X16	4845±25%	1.2(100kHz)

* AL-value: T=23°C, f=1kHz, H_m=0.4A/m

NI limit vs. AL-value for PE22 EC70X69X16



When applied magnetic field providing NI to a setting core for arbitrary AL-value, show each NI value when decreased 20% and 40% from initial AL-value.

AL-value vs. Air gap length for PE22 EC70X69X16



Temp. : 23°C
H_m : 0.4A/m
f : 1kHz

NI limit vs. AL-value for PC40 EC70X69X16

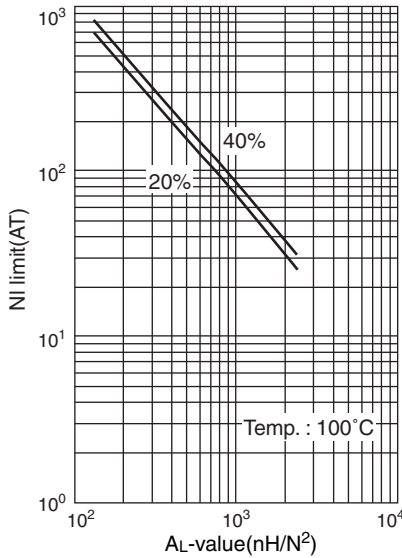

When applied magnetic field providing NI to a setting core for arbitrary AL-value, show each NI value when decreased 20% and 40% from initial AL-value.

AL-value vs. Air gap length for PC40 EC70X69X16



Temp. : 23°C
H_m : 0.4A/m
f : 1kHz

EC90X90X30



Parameter

Core constant	C1	mm ⁻¹	0.3533380
	C2×10 ⁻²	mm ⁻³	0.05648
Effective magnetic path length	ℓ _e	mm	221
Effective cross-sectional area	A _e	mm ²	626
Effective core volume	V _e	mm ³	138270
Cross-sectional center leg area	A _c	mm ²	707
Minimum cross-sectional area	A _{min.*}	mm ²	570B*
Winding cross-sectional area	A _{cw}	mm ²	1420
Weight(approx.)		g	635

* The symbol followed A min. value shows minimum cross-sectional area part.
C is center pole part, L is outer pole part, B is the back part.

Part No.	AL-value*(nH/N ²)	Calculated output power(kW) (forward converter mode)
PE22 EC90X90X30	5925±25%	3.2(100kHz)
PC40 EC90X90X30	7415±25%	3.4(100kHz)

* AL-value: T=23°C, f=1kHz, H_m=0.4A/m

NI limit vs. AL-value for PE22 EC90X90X30



When applied magnetic field providing NI to a setting core for arbitrary AL-value, show each NI value when decreased 20% and 40% from initial AL-value.

AL-value vs. Air gap length for PE22 EC90X90X30

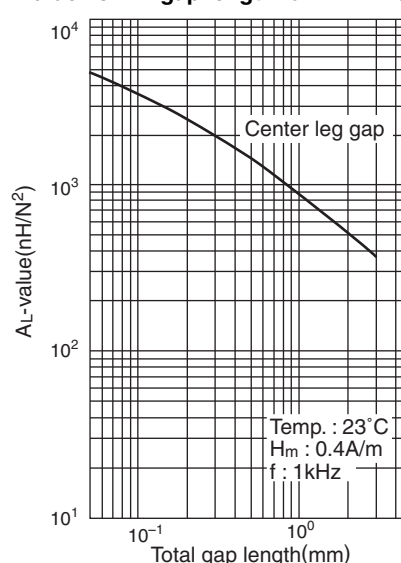

NI limit vs. AL-value for PC40 EC90X90X30

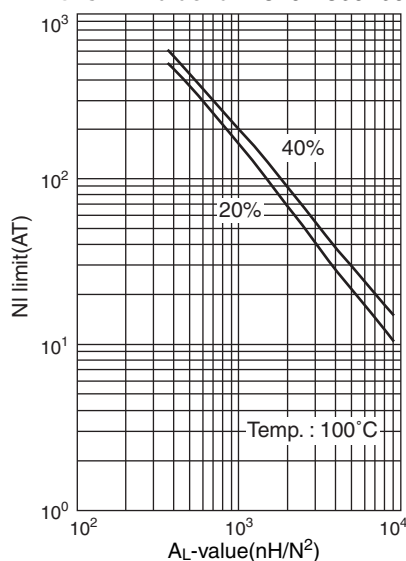

When applied magnetic field providing NI to a setting core for arbitrary AL-value, show each NI value when decreased 20% and 40% from initial AL-value.

AL-value vs. Air gap length for PC40 EC90X90X30

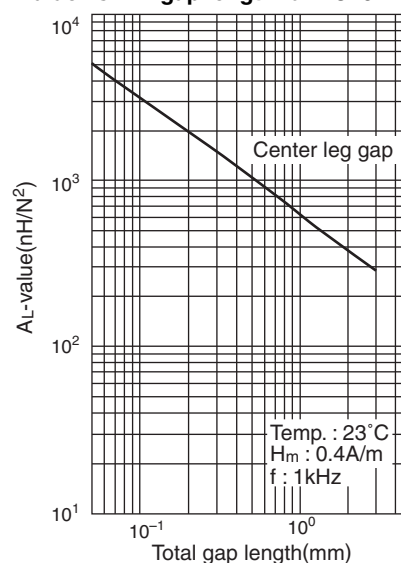

EC120X101X30



Parameter

Core constant	C1	mm ⁻¹	0.3300745
	C2×10 ⁻²	mm ⁻³	0.04278
Effective magnetic path length	ℓ _e	mm	255
Effective cross-sectional area	A _e	mm ²	773
Effective core volume	V _e	mm ³	196490
Cross-sectional center leg area	A _c	mm ²	707
Minimum cross-sectional area	A _{min.*}	mm ²	707C*
Winding cross-sectional area	A _{cw}	mm ²	2307
Weight(approx.)	g		986

* The symbol followed A min. value shows minimum cross-sectional area part.
C is center pole part, L is outer pole part, B is the back part.

Part No.	AL-value*(nH/N ²)	Calculated output power(kW) (forward converter mode)
PE22 EC120X101X30	6395±25%	4.3(100kHz)
PC40 EC120X101X30	8025±25%	4.5(100kHz)

* AL-value: T=23°C, f=1kHz, H_m=0.4A/m

NI limit vs. AL-value for PE22 EC120X101X30



When applied magnetic field providing NI to a setting core for arbitrary AL-value, show each NI value when decreased 20% and 40% from initial AL-value.

AL-value vs. Air gap length for PE22 EC120X101X30



NI limit vs. AL-value for PC40 EC120X101X30



When applied magnetic field providing NI to a setting core for arbitrary AL-value, show each NI value when decreased 20% and 40% from initial AL-value.

AL-value vs. Air gap length for PC40 EC120X101X30

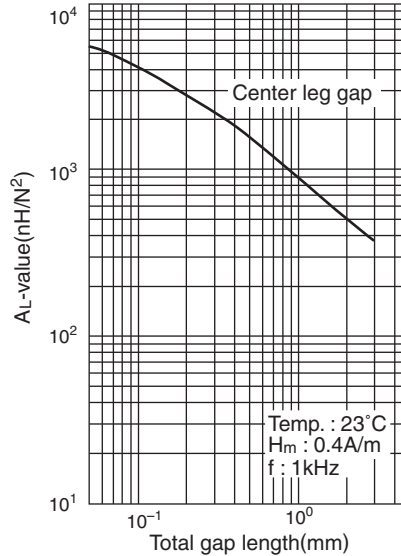

EIC Series

EIC CORE

CORE SHAPES AND DIMENSIONS/CHARACTERISTICS



PRODUCT IDENTIFICATION

PE22 EIC 90 × 55 × 30
(1) (2) (3) (4) (5)

- (1) Material name
- (2) Shape
- (3) Dimension A
- (4) Dimension B+l
- (5) Dimension C

Part No.	AL*(nH/N ²) ±25%	Dimensions (mm)										
		A	B+l	C	øD	øE	F	I	M	J	K	
PE22 EIC70×46×16	5550											
PC40 EIC70×46×16	6810	70.0±1.7	46.25±1.0	16.4±0.5	16.4±0.5	43.3min.	22.75±0.5	11.75±0.5	5.2	4.75	14.1	
PE90 EIC70×46×16	6514											
PE22 EIC90×55×30	8350											
PC40 EIC90×55×30	10365	90.0±1.8	55.0±1.0	30.0±1.0	30.0±1.0	68.5min.	35.5±0.5	10.0±0.35	5.5	6.0	20.0	
PE90 EIC90×55×30	9914											
PE22 EIC120×65×30	8890											
PC40 EIC120×65×30	11085	120.0±2.0	65.5±1.3	30.0±1.0	30.0±1.0	93.3min.	35.5±0.5	15.0±0.65	5.5	6.0	32.5	
PE90 EIC120×65×30	10603											

*Measuring condition: T=23°C, f=1kHz, H_m=0.4A/m

Part No.	Core factor					Weight (g)
	C ₁ (mm ⁻¹)	C ₂ ×10 ⁻² (mm ⁻³)	A _e (mm ²)	ℓ _e (mm)	V _e (mm ³)	
PE22 EIC70×46×16						188
PC40 EIC70×46×16	0.3479	0.1173	297	103	30601	188
PE90 EIC70×46×16						191
PE22 EIC90×55×30						469
PC40 EIC90×55×30	0.2422	0.0388	624	151	94432	469
PE90 EIC90×55×30						479
PE22 EIC120×65×30						747
PC40 EIC120×65×30	0.2319	0.0292	794	184	146310	747
PE90 EIC120×65×30						763

EIC90X55X30



Parameter

Core constant	C ₁	mm ⁻¹	0.2422
	C ₂ ×10 ⁻²	mm ⁻³	0.0388
Effective magnetic path length	ℓ _e	mm	151
Effective cross-sectional area	A _e	mm ²	624
Effective core volume	V _e	mm ³	94432
Cross-sectional center leg area	A _c	mm ²	707
Minimum cross-sectional area	A _{min.*}	mm ²	586B*
Winding cross-sectional area	A _{cw}	mm ²	710
Weight(approx.)	g		469

* The symbol followed A min. value shows minimum cross-sectional area part.
C is center pole part, L is outer pole part, B is the back part.

Part No.	AL-value*(nH/N ²)	Calculated output power(kW) (forward converter mode)
PE22 EIC90X55X30	8350±25%	1.8(100kHz)
PC40 EIC90X55X30	10365±25%	1.9(100kHz)
PE90 EIC90X55X30	9914±25%	—

* AL-value: T=23°C, f=1kHz, H_m=0.4A/m

EIC120X65X30



Parameter

Core constant	C ₁	mm ⁻¹	0.2319
	C ₂ ×10 ⁻²	mm ⁻³	0.0292
Effective magnetic path length	ℓ _e	mm	184
Effective cross-sectional area	A _e	mm ²	794
Effective core volume	V _e	mm ³	146310
Cross-sectional center leg area	A _c	mm ²	707
Minimum cross-sectional area	A _{min.*}	mm ²	707C*
Cross-sectional winding area of core	A _{cw}	mm ²	1154
Weight(approx.)	g		747

* The symbol followed A min. value shows minimum cross-sectional area part.
C is center pole part, L is outer pole part, B is the back part.

Part No.	AL-value*(nH/N ²)	Calculated output power(kW) (forward converter mode)
PE22 EIC120X65X30	8890±25%	2.8(100kHz)
PC40 EIC120X65X30	11085±25%	2.9(100kHz)
PE90 EIC120X65X30	10603±25%	—

* AL-value: T=23°C, f=1kHz, H_m=0.4A/m

• Available customize core like this. Please specify when ordering.

EE Series

EE CORE

CORE SHAPES AND DIMENSIONS/CHARACTERISTICS



PRODUCT IDENTIFICATION

PE22 EE 320 × 250 × 20
 (1) (2) (3) (4) (5)

- (1) Material name
- (2) Shape
- (3) Dimension A
- (4) Dimension 2B
- (5) Dimension C

Part No.	AL*(nH/N ²) ±25%	Dimensions (mm)										
		A	2B	C	D	E	2F	H	R	K	K×2F(mm ²)	
PE22 EE70×91×19	3930											
PC40 EE70×91×19	4910	70.0±1.5	91.0±1.0	19.5±0.5	19.5±0.5	48.5min.	71.0±1.0	10.0±0.5	0	15.3	1086	
PE90 EE70×91×19	4697											
PE22 EE80×76×20	4590											
PC40 EE80×76×20	5720	80.0±1.5	76.0±1.0	20.0±0.5	20.0±0.5	58.5min.	55.0±0.8	10.0±0.5	0.5max.	20.0	1100	
PE90 EE80×76×20	5471											
PE22 EE90×56×16	5960											
PC40 EE90×56×16	7380	90.0±2.0	56.4±1.0	16.5±0.5	25.0±1.0	63.0min.	30.4±1.0	12.5±0.5	0.5max.	20.0	608	
PE90 EE90×56×16	7059											
PE22 EE70×108×31N	6360											
PC40 EE70×108×31N	7970	70.0±1.5	108.0±1.0	31.6±0.5	22.2±0.5	46.3min.	85.6±1.0	11.1±0.5	2.0max.	12.8	1096	
PE90 EE70×108×31N	7623											

* Measuring condition: T=23°C, f=1kHz, H_m=0.4A/m

Part No.	Core factor					Weight (g)
	C ₁ (mm ⁻¹)	C ₂ ×10 ⁻² (mm ⁻³)	A _e (mm ²)	l _e (mm)	V _e (mm ³)	
PE22 EE70×91×19						394
PC40 EE70×91×19	0.52779	0.13669	386	204	78690	394
PE90 EE70×91×19						402
PE22 EE80×76×20						372
PC40 EE80×76×20	0.44878	0.11058	406	182	73910	372
PE90 EE80×76×20						380
PE22 EE90×56×16						306
PC40 EE90×56×16	0.33583	0.08009	419	141	59050	306
PE90 EE90×56×16						312
PE22 EE70×108×31N						815
PC40 EE70×108×31N	0.32992	0.04695	703	232	162900	815
PE90 EE70×108×31N						832

EE CORE BOBBIN



Bobbin is optional parts.

EE CORE BOBBIN

Part No.	Dimensions (mm)						Cross-sectional winding area $A_w(\text{mm}^2)$	Average winding length $\bar{l}_w(\text{mm})$	Weight (g)	Material
	A ₁	A ₂	B ₁	B ₂	C	Z				
BE-80-S	56.5±0.5	61.0±0.5	25.2±0.5	25.2±0.5	47.5±2.5	51.5±2.5	747	168	32	PBT
BE-80-W	56.5±0.5	81.5±0.7	25.2±0.5	45.8±0.5	47.5±2.5	51.5±2.5	747	209	41	PBT

EE70X91X19



Parameter

Core constant	C ₁	mm ⁻¹	0.5278
	C ₂ ×10 ⁻²	mm ⁻³	0.1367
Effective magnetic path length	ℓ _e	mm	204
Effective cross-sectional area	A _e	mm ²	386
Effective core volume	V _e	mm ³	78690
Cross-sectional center leg area	A _c	mm ²	380
Minimum cross-sectional area	A _{min.*}	mm ²	380C*
Winding cross-sectional area	A _{cw}	mm ²	1086
Weight(approx.)	g		394

* The symbol followed A min. value shows minimum cross-sectional area part.
C is center pole part, L is outer pole part, B is the back part.

Part No.	AL-value*(nH/N ²)	Calculated output power(kW) (forward converter mode)
PE22 EE70X91X19	3930±25%	1.4(100kHz)
PC40 EE70X91X19	4910±25%	1.6(100kHz)

* AL-value: T=23°C, f=1kHz, H_m=0.4A/m

NI limit vs. AL-value for PE22 EE70X91X19



When applied magnetic field providing NI to a setting core for arbitrary AL-value, show each NI value when decreased 20% and 40% from initial AL-value.

AL-value vs. Air gap length for PE22 EE70X91X19

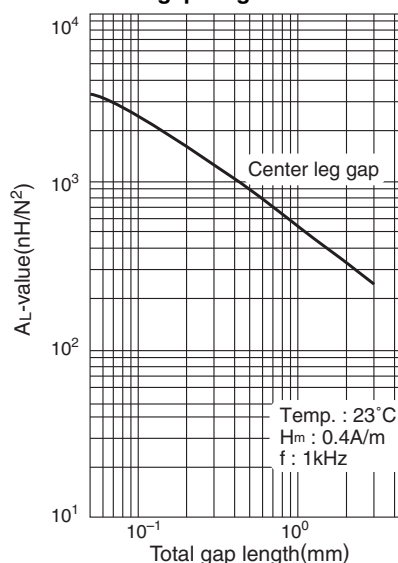

NI limit vs. AL-value for PC40 EE70X91X19



When applied magnetic field providing NI to a setting core for arbitrary AL-value, show each NI value when decreased 20% and 40% from initial AL-value.

AL-value vs. Air gap length for PC40 EE70X91X19

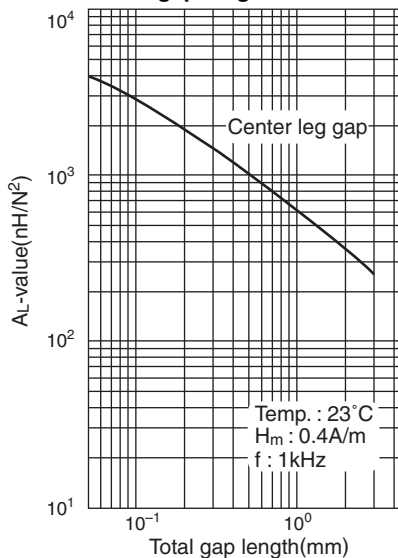

EE80X76X20



Parameter

Core constant	C ₁	mm ⁻¹	0.44878
	C ₂ ×10 ⁻²	mm ⁻³	0.1106
Effective magnetic path length	ℓ _e	mm	182
Effective cross-sectional area	A _e	mm ²	406
Effective core volume	V _e	mm ³	73910
Cross-sectional center leg area	A _c	mm ²	400
Minimum cross-sectional area	A _{min.*}	mm ²	400LC*
Winding cross-sectional area	A _{cw}	mm ²	1100
Weight(approx.)	g		372

* The symbol followed A min. value shows minimum cross-sectional area part. C is center pole part, L is outer pole part, B is the back part.

Part No.	AL-value*(nH/N ²)	Calculated output power(kW) (forward converter mode)
PE22 EE80X76X20	4590±25%	1.4(100kHz)
PC40 EE80X76X20	5720±25%	1.5(100kHz)

* AL-value: T=23°C, f=1kHz, H_m=0.4A/m

NI limit vs. AL-value for PE22 EE80X76X20



When applied magnetic field providing NI to a setting core for arbitrary AL-value, show each NI value when decreased 20% and 40% from initial AL-value.

AL-value vs. Air gap length for PE22 EE80X76X20



NI limit vs. AL-value for PC40 EE80X76X20



When applied magnetic field providing NI to a setting core for arbitrary AL-value, show each NI value when decreased 20% and 40% from initial AL-value.

AL-value vs. Air gap length for PC40 EE80X76X20



EE90X56X16



Parameter

Core constant	C1	mm ⁻¹	0.33583
	C2×10 ⁻²	mm ⁻³	0.0801
Effective magnetic path length	ℓ _e	mm	141
Effective cross-sectional area	A _e	mm ²	419
Effective core volume	V _e	mm ³	59050
Cross-sectional center leg area	A _c	mm ²	413
Minimum cross-sectional area	A _{min.*}	mm ²	413LC*
Winding cross-sectional area	A _{cw}	mm ²	608
Weight(approx.)		g	306

* The symbol followed A min. value shows minimum cross-sectional area part. C is center pole part, L is outer pole part, B is the back part.

Part No.	AL-value*(nH/N ²)	Calculated output power(kW) (forward converter mode)
PE22 EE90X56X16	5960±25%	1.2(100kHz)
PC40 EE90X56X16	7380±25%	1.3(100kHz)

* AL-value: T=23°C, f=1kHz, H_m=0.4A/m

NI limit vs. AL-value for PE22 EE90X56X16



When applied magnetic field providing NI to a setting core for arbitrary AL-value, show each NI value when decreased 20% and 40% from initial AL-value.

AL-value vs. Air gap length for PE22 EE90X56X16



NI limit vs. AL-value for PC40 EE90X56X16



When applied magnetic field providing NI to a setting core for arbitrary AL-value, show each NI value when decreased 20% and 40% from initial AL-value.

AL-value vs. Air gap length for PC40 EE90X56X16



EI Series

EI CORE

CORE SHAPES AND DIMENSIONS/CHARACTERISTICS



PRODUCT IDENTIFICATION

$\frac{PE22}{(1)}$
 $\frac{EI}{(2)}$
 $\frac{70}{(3)}$
 \times
 $\frac{55}{(4)}$
 \times
 $\frac{19}{(5)}$

- (1) Material name
 (2) Shape
 (3) Dimension A
 (4) Dimension B+l
 (5) Dimension C

Part No.	AL*(nH/N ²) ±25%	Dimensions (mm)												
		A	B+l	C	D	E	F	H	I	R	K	K×F(mm ²)		
PE22 EI70×55×19	5880													
PC40 EI70×55×19	7270	70.0±1.5	55.5±1.0	19.5±0.5	19.5±0.5	48.5min.	35.0±0.5	10.0±0.5	10.5±0.5	0.5max.	15.3	536		
PE90 EI70×55×19	6954													
PE22 EI70×64×31N	9585													
PC40 EI70×64×31N	11885	70.0±1.5	64.4±1.0	31.6±0.5	22.2±0.5	46.3min.	42.8±0.5	11.1±0.5	10.4±0.5	2.0max.	12.8	548		
PE90 EI70×64×31N	11368													

* Measuring condition: T=23°C, f=1kHz, H_m=0.4A/m

Part No.	Core factor					Weight (g)
	C ₁ (mm ⁻¹)	C ₂ ×10 ⁻² (mm ⁻³)	A _e (mm ²)	ℓ _e (mm)	V _e (mm ³)	
PE22 EI70×55×19						266
PC40 EI70×55×19	0.33894	0.08693	390	132	51520	266
PE90 EI70×55×19						272
PE22 EI70×64×31N						519
PC40 EI70×64×31N	0.20929	0.03010	695	146	101200	519
PE90 EI70×64×31N						530

EI70X55X19



Parameter

Core constant	C1	mm ⁻¹	0.33894
	C2×10 ⁻²	mm ⁻³	0.08693
Effective magnetic path length	ℓ _e	mm	132
Effective cross-sectional area	A _e	mm ²	390
Effective core volume	V _e	mm ³	51520
Cross-sectional center leg area	A _c	mm ²	380
Minimum cross-sectional area	A _{min.*}	mm ²	380C*
Winding cross-sectional area	A _{cw}	mm ²	543
Weight(approx.)	g		266

* The symbol followed A min. value shows minimum cross-sectional area part.
C is center pole part, L is outer pole part, B is the back part.

Part No.	AL-value*(nH/N ²)	Calculated output power(kW) (forward converter mode)
PE22 EI70X55X19	5880±25%	1.4(100kHz)
PC40 EI70X55X19	7270±25%	1.6(100kHz)

* AL-value: T=23°C, f=1kHz, H_m=0.4A/m

NI limit vs. AL-value for PE22 EI70X55X19



When applied magnetic field providing NI to a setting core for arbitrary AL-value, show each NI value when decreased 20% and 40% from initial AL-value.

AL-value vs. Air gap length for PE22 EI70X55X19



Temp. : 23°C
H_m : 0.4A/m
f : 1kHz

NI limit vs. AL-value for PC40 EI70X55X19



When applied magnetic field providing NI to a setting core for arbitrary AL-value, show each NI value when decreased 20% and 40% from initial AL-value.

AL-value vs. Air gap length for PC40 EI70X55X19



Temp. : 23°C
H_m : 0.4A/m
f : 1kHz

DT Series

DT CORE

CORE SHAPES AND DIMENSIONS/CHARACTERISTICS



$$R_1 = 1/2B$$

$$R_2 = 1/2E$$



PRODUCT IDENTIFICATION

PE22 DT 138 × 20 × 58
(1) (2) (3) (4) (5)

- (1) Material name
- (2) Shape
- (3) Dimension A
- (4) Dimension C
- (5) Dimension D

Part No.	AL ^{*1} (nH/N ²) ±25%	Dimensions (mm)				
		A	B	C	D	E
PE22 DT138×20×58 ^{*2}	6680					
PC40 DT138×20×58 ^{*2}	8540	138.0±2.8	104.0±2.1	20.0±0.4	58.0±1.5	24.7±0.5
PE90 DT138×20×58 ^{*2}	8169					

*1 Measuring condition: T=23°C, f=1kHz, H_m=0.4A/m

*2 DT138×20×58 and DT200×20×102 are both sides grinding machined products.

Part No.	Core factor					Weight (g)
	C ₁ (mm ⁻¹)	C ₂ ×10 ⁻² (mm ⁻³)	A _e (mm ²)	l _e (mm)	V _e (mm ³)	
PE22 DT138×20×58						1020
PC40 DT138×20×58	0.33806	0.04235	798	270	215000	1020
PE90 DT138×20×58						1041

PQ Series

PQ CORE

CORE SHAPES AND DIMENSIONS/CHARACTERISTICS



PRODUCT IDENTIFICATION

PE22	PQ	$\frac{78}{(1)}$	$\times \frac{39}{(2)}$	$\times \frac{42}{(3)}$	$\frac{42}{(4)}$	$\frac{42}{(5)}$
------	----	------------------	-------------------------	-------------------------	------------------	------------------

- (1) Material name
- (2) Shape
- (3) Dimension A₁
- (4) Dimension 2D
- (5) Dimension A₂

PQ CORE BOBBIN



Bobbin is optional parts.

Part No.	Al*(nH/N ²) ±25%	Dimensions (mm)							
		A ₁	A ₂	B	ØC	2D	E	2H	
PE22 PQ78×39×42	7940								
PC40 PQ78×39×42	9790	78.5±1.5	42.0±0.8	69.0min.	25.5±0.5	39.4±0.6	60.0min.	25.8±1.0	
PE90 PQ78×39×42	9364								
PE22 PQ107×87×70	14570								
PC40 PQ107×87×70	18210	107.0±2.0	70.0±1.5	93.7min.	41.0±1.0	87.0±1.5	72.5min.	56.0±1.5	
PE90 PQ107×87×70	17418								

* Measuring condition: T=23°C, f=1kHz, H_m=0.4A/m

Part No.	Core factor						Weight(g)
	C ₁ (mm ⁻¹)	C ₂ ×10 ⁻² (mm ⁻³)	A _e (mm ²)	ℓ _e (mm)	V _e (mm ³)		
PE22 PQ78×39×42						304	
PC40 PQ78×39×42	0.24730	0.051530	480	119	56900	304	
PE90 PQ78×39×42						310	
PE22 PQ107×87×70						1560	
PC40 PQ107×87×70	0.14260	0.009989	1428	204	290600	1560	
PE90 PQ107×87×70						1593	

PQ CORE BOBBIN

Part No.	Dimensions (mm)								Cross-sectional winding area A _w (mm ²)	Average winding length ℓ _w (mm)	Material
	ØA	ØB	ØC	D	E	X	Y	Z			
BPQ78	67.8±0.3	30.2±0.5	26.8±0.5	23.5±2.0	20.0±2.0	57.5±0.5	78.0±0.5	31.0±2.0	377	154	PBT
BPQ107	92.5±0.5	42.7±0.5	46.7±0.5	53.5±2.5	49.5±3.0	69.5±0.5	100.0±0.5	71.0±2.5	1140	218	PBT

• Soldering condition: 350°C max./2s

PQ78X39X42

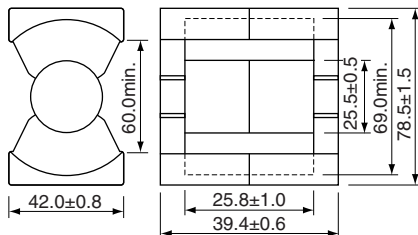

Dimensions in mm

Parameter

Core constant	C1	mm ⁻¹	0.2473
	C2×10 ⁻²	mm ⁻³	0.05153
Effective magnetic path length	ℓ _e	mm	119
Effective cross-sectional area	A _e	mm ²	480
Effective core volume	V _e	mm ³	56900
Cross-sectional center leg area	A _c	mm ²	510
Minimum cross-sectional area	A _{min.*}	mm ²	510C*
Winding cross-sectional area	A _{cw}	mm ²	570
Weight(approx.)	g		304

* The symbol followed A min. value shows minimum cross-sectional area part.
C is center pole part, L is outer pole part, B is the back part.

Part No.	AL-value*(nH/N ²)	Calculated output power(kW) (forward converter mode)
PE22 PQ78X39X42	7940±25%	1.6(100kHz)
PC40 PQ78X39X42	9790±25%	1.7(100kHz)

* AL-value: T=23°C, f=1kHz, H_m=0.4A/m

• Available customize core like this. Please specify when ordering.

NI limit vs. AL-value for PE22 PQ78X39X42



When applied magnetic field providing NI to a setting core for arbitrary AL-value, show each NI value when decreased 20% and 40% from initial AL-value.

AL-value vs. Air gap length for PE22 PQ78X39X42

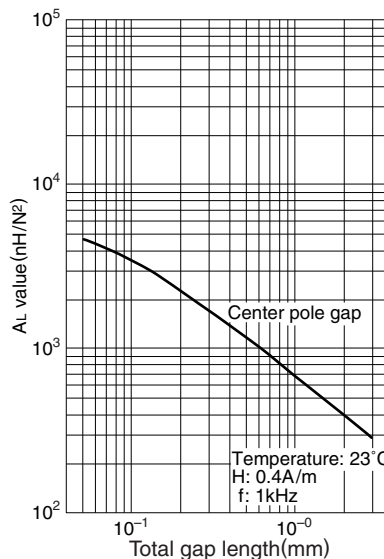

NI limit vs. AL-value for PC40 PQ78X39X42

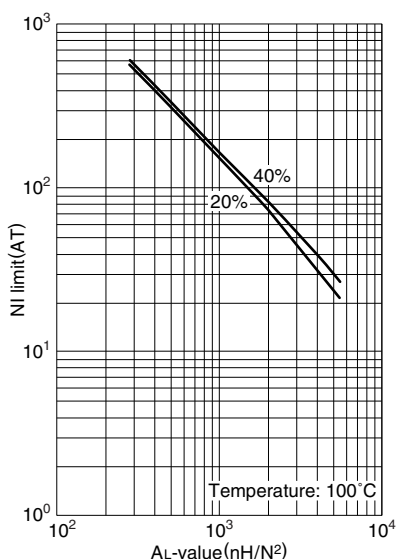

When applied magnetic field providing NI to a setting core for arbitrary AL-value, show each NI value when decreased 20% and 40% from initial AL-value.

AL-value vs. Air gap length for PC40 PQ78X39X42

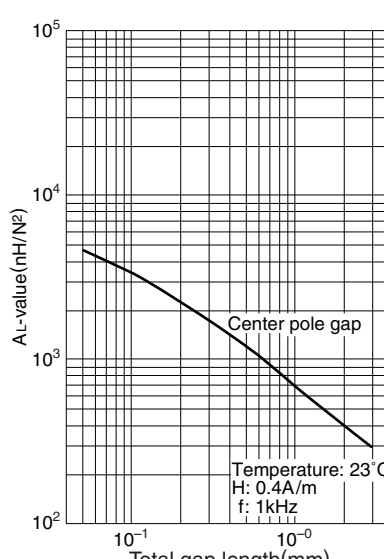

PQ107X87X70



Parameter

Core constant	C1	mm ⁻¹	0.1426
	C2×10 ⁻²	mm ⁻³	0.009989
Effective magnetic path length	ℓ _e	mm	204
Effective cross-sectional area	A _e	mm ²	1428
Effective core volume	V _e	mm ³	290600
Cross-sectional center leg area	A _c	mm ²	1320
Minimum cross-sectional area	A _{min.*}	mm ²	1320C*
Winding cross-sectional area	A _{cw}	mm ²	1540
Weight(approx.)	g		1560

* The symbol followed A min. value shows minimum cross-sectional area part.
C is center pole part, L is outer pole part, B is the back part.

Part No.	AL-value*(nH/N ²)	Calculated output power(kW) (forward converter mode)
PE22 PQ107X87X70	14570±25%	8.3(100kHz)
PC40 PQ107X87X70	18210±25%	9.0(100kHz)

* AL-value: T=23°C, f=1kHz, H_m=0.4A/m

• Available customize core like this. Please specify when ordering.

NI limit vs. AL-value for PE22 PQ107X87X70



When applied magnetic field providing NI to a setting core for arbitrary AL-value, show each NI value when decreased 20% and 40% from initial AL-value.

AL-value vs. Air gap length for PE22 PQ107X87X70



NI limit vs. AL-value for PC40 PQ107X87X70

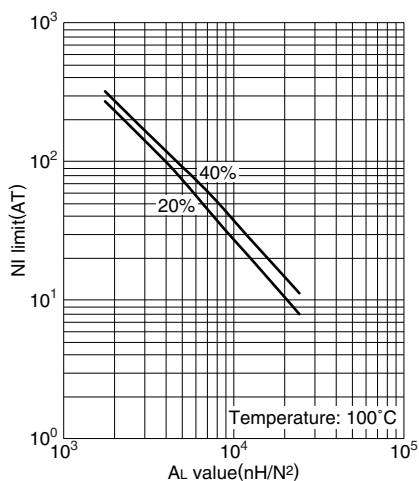

When applied magnetic field providing NI to a setting core for arbitrary AL-value, show each NI value when decreased 20% and 40% from initial AL-value.

AL-value vs. Air gap length for PC40 PQ107X87X70



SP Series

SP CORE

CORE SHAPES AND DIMENSIONS/CHARACTERISTICS

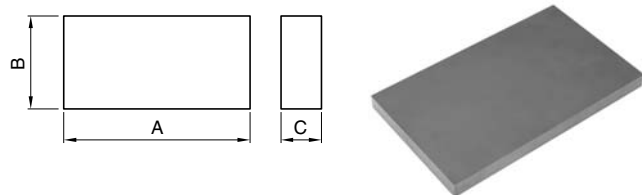

PRODUCT IDENTIFICATION

PE22 SP 135 × 65 × 20
 (1) (2) (3) (4) (5)

- (1) Material name
- (2) Shape
- (3) Dimension A
- (4) Dimension B
- (5) Dimension C

Part No.	Dimensions (mm)		
	A	B	C
PE22 SP59×19×5			
PC40 SP59×19×5	59.0±1.0	19.5±0.5	5.0±0.5
PE90 SP59×19×5			
PE22 SP65×10×5			
PC40 SP65×10×5	65.0±1.5	10.0±0.5	5.0±0.5
PE90 SP65×10×5			
PE22 SP79×70×10			
PC40 SP79×70×10	79.0±1.5	70.0±1.5	10.0±0.5
PE90 SP79×70×10			
PE22 SP135×65×20			
PC40 SP135×65×20	135.0±2.5	65.0±1.5	20.0±0.5
PE90 SP135×65×20			

Данный компонент на территории Российской Федерации

Вы можете приобрести в компании MosChip.

Для оперативного оформления запроса Вам необходимо перейти по данной ссылке:

<http://moschip.ru/get-element>

Вы можете разместить у нас заказ для любого Вашего проекта, будь то серийное производство или разработка единичного прибора.

В нашем ассортименте представлены ведущие мировые производители активных и пассивных электронных компонентов.

Нашей специализацией является поставка электронной компонентной базы двойного назначения, продукции таких производителей как XILINX, Intel (ex.ALTERA), Vicor, Microchip, Texas Instruments, Analog Devices, Mini-Circuits, Amphenol, Glenair.

Сотрудничество с глобальными дистрибьюторами электронных компонентов, предоставляет возможность заказывать и получать с международных складов практически любой перечень компонентов в оптимальные для Вас сроки.

На всех этапах разработки и производства наши партнеры могут получить квалифицированную поддержку опытных инженеров.

Система менеджмента качества компании отвечает требованиям в соответствии с ГОСТ Р ИСО 9001, ГОСТ РВ 0015-002 и ЭС РД 009

Офис по работе с юридическими лицами:

105318, г.Москва, ул.Щербаковская д.3, офис 1107, 1118, ДЦ «Щербаковский»

Телефон: +7 495 668-12-70 (многоканальный)

Факс: +7 495 668-12-70 (доб.304)

E-mail: info@moschip.ru

Skype отдела продаж:

moschip.ru

moschip.ru_4

moschip.ru_6

moschip.ru_9