

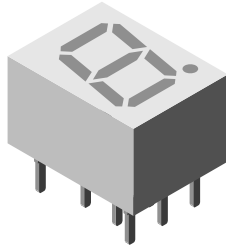

Standard 7-Segment Display 7 mm



19235

DESCRIPTION

The TDS.11.. series are 7 mm character seven segment LED displays in a very compact package.

The displays are designed for a viewing distance up to 3 m and available in four bright colors. The grey package surface and the evenly lighted untinted segments provide an optimum on-off contrast.

All displays are categorized in luminous intensity groups. That allows users to assemble displays with uniform appearance. Typical applications include instruments, panel meters, point-of-sale terminals and household equipment.

FEATURES

- Evenly lighted segments
- Grey package surface
- Untinted segments
- Luminous intensity categorized
- Yellow and green categorized for color
- Wide viewing angle
- Suitable for DC and high peak current
- Material categorization: For definitions of compliance please see www.vishay.com/doc?99912



RoHS
COMPLIANT

APPLICATIONS

- Panel meters
- Test- and measure-equipment
- Point-of-sale terminals
- Control units

PRODUCT GROUP AND PACKAGE DATA

- Product group: Display
- Package: 7 mm
- Product series: Standard
- Angle of half intensity: $\pm 50^\circ$

PARTS TABLE														
PART	COLOR	LUMINOUS INTENSITY (μcd)			at I_F (mA)	WAVELENGTH (nm)			at I_F (mA)	FORWARD VOLTAGE (V)			at I_F (mA)	CIRCUITRY
		MIN.	TYP.	MAX.		MIN.	TYP.	MAX.		MIN.	TYP.	MAX.		
TDSO1150	Orange red	450	3000	-	10	612	-	625	10	-	2	3	20	Common anode
TDSO1150-K	Orange red	1800	-	3600	10	612	-	625	10	-	2	3	20	Common anode
TDSO1160	Orange red	450	3000	-	10	612	-	625	10	-	2	3	20	Common cathode
TDSO1160-K	Orange red	1800	-	3600	10	612	-	625	10	-	2	3	20	Common cathode
TDSO1160-KL	Orange red	1800	-	5600	10	612	-	625	10	-	2	3	20	Common cathode
TDSY1150	Yellow	450	3000	-	10	581	-	594	10	-	2.4	3	20	Common anode
TDSY1150-K	Yellow	1800	-	3600	10	581	-	594	10	-	2.4	3	20	Common anode
TDSY1150-KL	Yellow	1800	-	5600	10	581	-	594	10	-	2.4	3	20	Common anode
TDSY1160	Yellow	450	3000	-	10	581	-	594	10	-	2.4	3	20	Common cathode
TDSG1150	Green	450	6000	-	10	562	-	575	10	-	2.4	3	20	Common anode
TDSG1150-LM	Green	2800	-	9000	10	562	-	575	10	-	2.4	3	20	Common anode
TDSG1160	Green	450	6000	-	10	562	-	575	10	-	2.4	3	20	Common cathode
TDSG1160-LM	Green	2800	-	9000	10	562	-	575	10	-	2.4	3	20	Common cathode



ABSOLUTE MAXIMUM RATINGS ($T_{amb} = 25\text{ }^{\circ}\text{C}$, unless otherwise specified) TDSO1150, TDSO1160, TDSY1150, TDSY1160, TDSG1150, TDSG1160				
PARAMETER	TEST CONDITION	SYMBOL	VALUE	UNIT
Reverse voltage per segment or DP		V_R	6	V
DC forward current per segment or DP		I_F	17	mA
Surge forward current per segment or DP	$t_p \leq 10\text{ }\mu\text{s}$ (non repetitive)	I_{FSM}	0.15	A
Power dissipation	$T_{amb} \leq 45\text{ }^{\circ}\text{C}$	P_V	400	mW
Junction temperature		T_j	100	$^{\circ}\text{C}$
Operating temperature range		T_{amb}	-40 to +85	$^{\circ}\text{C}$
Storage temperature range		T_{stg}	-40 to +85	$^{\circ}\text{C}$
Soldering temperature	$t \leq 3\text{ s}$, 2 mm below seating plane	T_{sd}	260	$^{\circ}\text{C}$
Thermal resistance LED junction/ambient		R_{thJA}	140	K/W

OPTICAL AND ELECTRICAL CHARACTERISTICS ($T_{amb} = 25\text{ }^{\circ}\text{C}$, unless otherwise specified) TDSO1150, TDSO1150-K, TDSO1160, TDSO1160-K, TDSO1160-KL, ORANGE RED							
PARAMETER	TEST CONDITION	PART	SYMBOL	MIN.	TYP.	MAX.	UNIT
Luminous intensity per segment (digit average) ⁽¹⁾	$I_F = 10\text{ mA}$	TDSO1150	I_V	450	3000	-	μcd
		TDSO1150-K		1800	-	3600	
		TDSO1160		450	3000	-	
		TDSO1160-K		1800	-	3600	
		TDSO1160-KL		1800	-	5600	
Dominant wavelength	$I_F = 10\text{ mA}$	TDSO1150, TDSO1150-K, TDSO1160, TDSO1160-K, TDSO1160-KL	λ_d	612	-	625	nm
Peak wavelength	$I_F = 10\text{ mA}$		λ_p	-	630	-	nm
Angle of half intensity	$I_F = 10\text{ mA}$		j	-	± 50	-	deg
Forward voltage per segment or DP	$I_F = 20\text{ mA}$		V_F	-	2	3	V
Reverse voltage per segment or DP	$I_R = 10\text{ }\mu\text{A}$		V_R	6	15	-	V

Note

⁽¹⁾ I_{Vmin} . and I_V groups are mean values of all segments (a to g, D1 to D4), matching factor within segments is ≥ 0.5 , excluding decimal points and colon.

OPTICAL AND ELECTRICAL CHARACTERISTICS ($T_{amb} = 25\text{ }^{\circ}\text{C}$, unless otherwise specified) TDSY1150, TDSY1150-K, TDSY1150-KL, TDSO1160, YELLOW							
PARAMETER	TEST CONDITION	PART	SYMBOL	MIN.	TYP.	MAX.	UNIT
Luminous intensity per segment (digit average) ⁽¹⁾	$I_F = 10\text{ mA}$	TDSY1150	I_V	450	3000	-	μcd
		TDSY1150-K		1800	-	3600	
		TDSY1150-KL		1800	-	5600	
		TDSY1160		450	3000	-	
Dominant wavelength	$I_F = 10\text{ mA}$	TDSY1150, TDSY1150-K, TDSY1150-KL, TDSY1160	λ_d	581	-	594	nm
Peak wavelength	$I_F = 10\text{ mA}$		λ_p	-	585	-	nm
Angle of half intensity	$I_F = 10\text{ mA}$		j	-	± 50	-	deg
Forward voltage per segment or DP	$I_F = 20\text{ mA}$		V_F	-	2.4	3	V
Reverse voltage per segment or DP	$I_R = 10\text{ }\mu\text{A}$		V_R	6	15	-	V

Note

⁽¹⁾ I_{Vmin} . and I_V groups are mean values of all segments (a to g, D1 to D4), matching factor within segments is ≥ 0.5 , excluding decimal points and colon.



OPTICAL AND ELECTRICAL CHARACTERISTICS ($T_{amb} = 25\text{ }^{\circ}\text{C}$, unless otherwise specified)							
TDSG1150, TDSG1150-LM, TDSG1160, GREEN							
PARAMETER	TEST CONDITION	PART	SYMBOL	MIN.	TYP.	MAX.	UNIT
Luminous intensity per segment (digit average) ⁽¹⁾	$I_F = 10\text{ mA}$	TDSG1150	I_V	450	6000	-	μcd
		TDSG1150-LM		2800	-	9000	
		TDSG1160		450	6000	-	
		TDSG1160-LM		2800	-	9000	
Dominant wavelength	$I_F = 10\text{ mA}$	TDSG1150, TDSG1150-LM, TDSG1160, TDSG1160-LM	λ_d	562	-	575	nm
Peak wavelength	$I_F = 10\text{ mA}$		λ_p	-	565	-	nm
Angle of half intensity	$I_F = 10\text{ mA}$		j	-	± 50	-	deg
Forward voltage per segment or DP	$I_F = 20\text{ mA}$		V_F	-	2.4	3	V
Reverse voltage per segment or DP	$I_R = 10\text{ }\mu\text{A}$		V_R	6	15	-	V

Note

⁽¹⁾ I_{Vmin} . and I_V groups are mean values of all segments (a to g, D1 to D4), matching factor within segments is ≥ 0.5 , excluding decimal points and colon.

LUMINOUS INTENSITY CLASSIFICATION		
GROUP	LIGHT INTENSITY (μcd)	
	MIN.	MAX.
STANDARD		
E	180	360
F	280	560
G	450	900
H	700	1400
I	1100	2200
K	1800	3600
L	2800	5600
M	4500	9000
N	7000	14 000

Note

- The above type numbers represent the order groups which include only a few brightness groups. Only one group will be shipped in one tube (there will be no mixing of two groups in one tube). In order to ensure availability, single brightness groups will not be orderable.

COLOR CLASSIFICATION						
GROUP	ORANGE RED		YELLOW		GREEN	
	MIN.	MAX.	MIN.	MAX.	MIN.	MAX.
1	612	617	581	584		
2	616	621	583	586		
3	620	625	585	588	562	565
4			587	590	564	567
5			589	592	566	569
6			591	594	568	571
7					570	573
8					572	575

Note

- Wavelengths are tested at a current pulse duration of 25 ms and an accuracy of $\pm 1\text{ nm}$.

TYPICAL CHARACTERISTICS ($T_{amb} = 25\text{ }^{\circ}\text{C}$, unless otherwise specified)

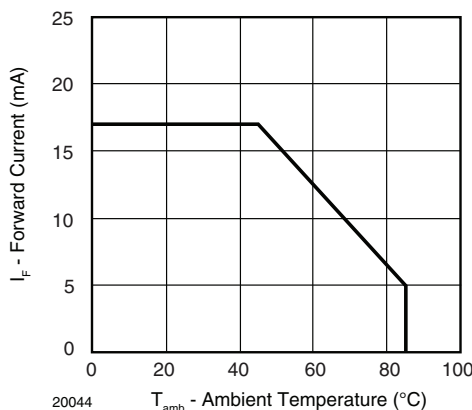

Fig. 1 - Forward Current vs. Ambient Temperature

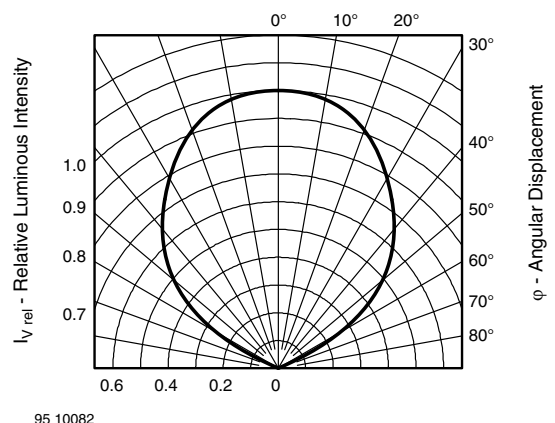
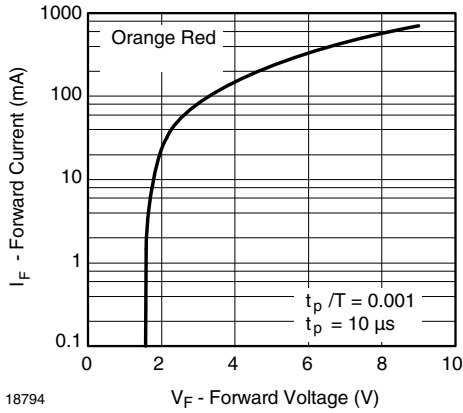
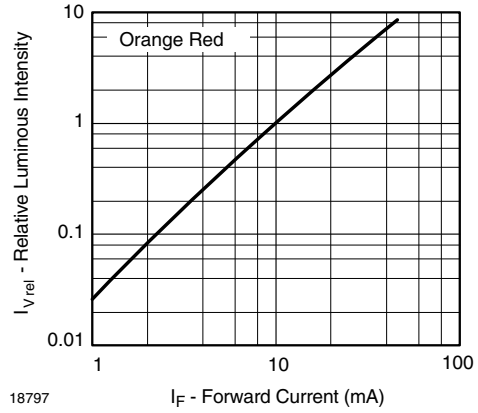

Fig. 2 - Relative Luminous Intensity vs. Angular Displacement



18794

Fig. 3 - Forward Current vs. Forward Voltage



18797

Fig. 6 - Relative Luminous Intensity vs. Forward Current

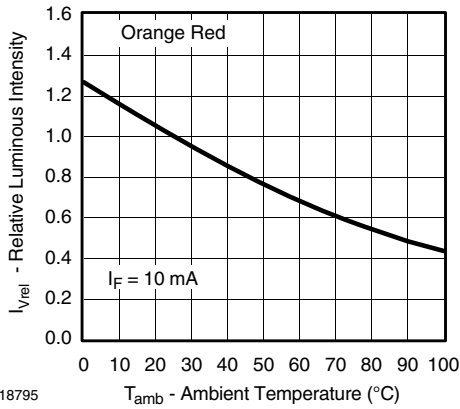

18795

Fig. 4 - Relative Luminous Intensity vs. Ambient Temperature

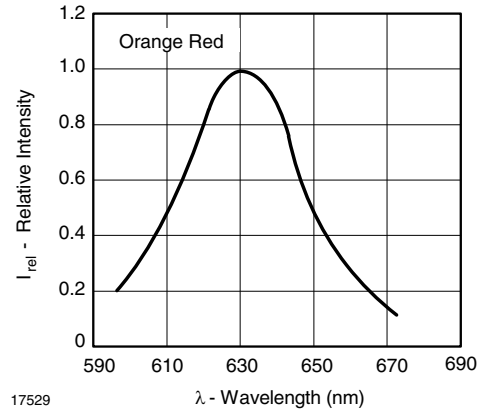

17529

Fig. 7 - Relative Intensity vs. Wavelength

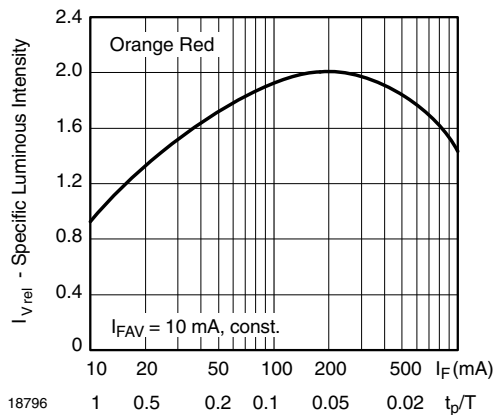

18796

Fig. 5 - Relative Luminous Intensity vs. Forward Current/Duty Cycle

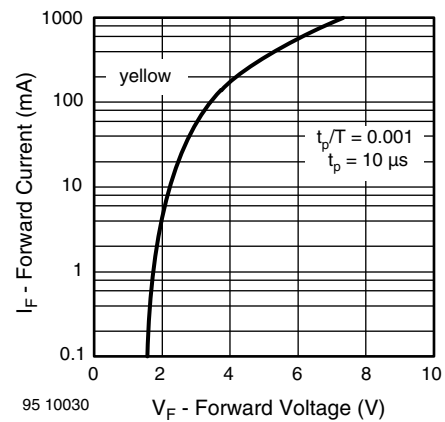

95 10030

Fig. 8 - Forward Current vs. Forward Voltage

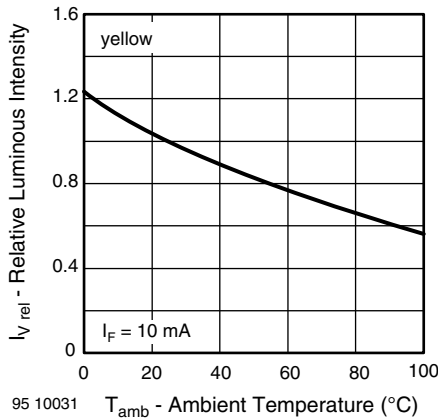

Fig. 9 - Relative Luminous Intensity vs. Ambient Temperature

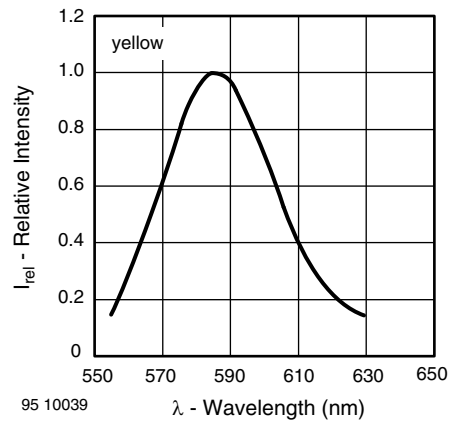

Fig. 12 - Relative Intensity vs. Wavelength

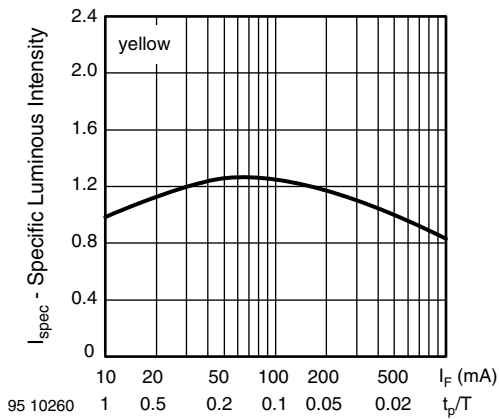

Fig. 10 - Relative Luminous Intensity vs. Forward Current/Duty Cycle

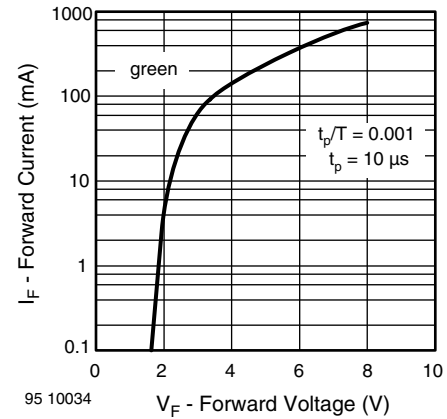

Fig. 13 - Forward Current vs. Forward Voltage

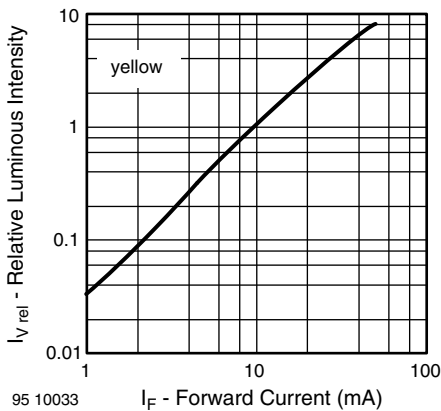

Fig. 11 - Relative Luminous Intensity vs. Forward Current

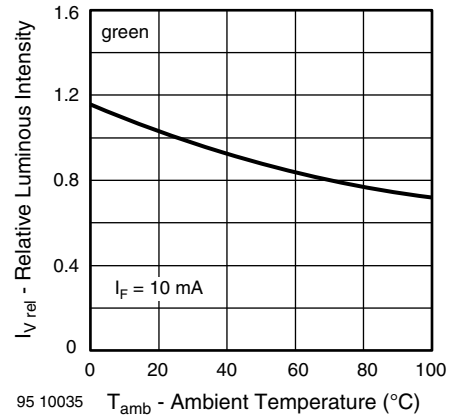

Fig. 14 - Relative Luminous Intensity vs. Ambient Temperature

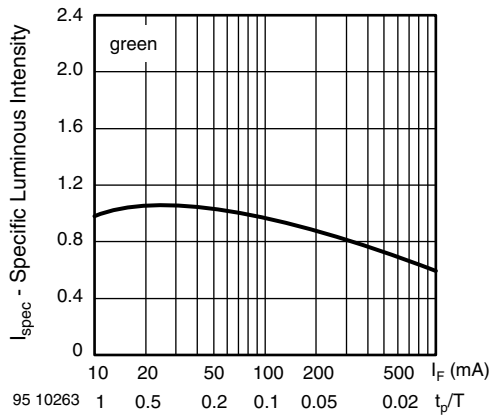

Fig. 15 - Specific Luminous Intensity vs. Forward Current



Fig. 17 - Relative Intensity vs. Wavelength

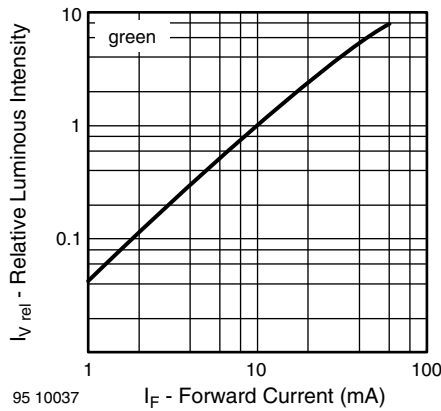

Fig. 16 - Relative Luminous Intensity vs. Forward Current

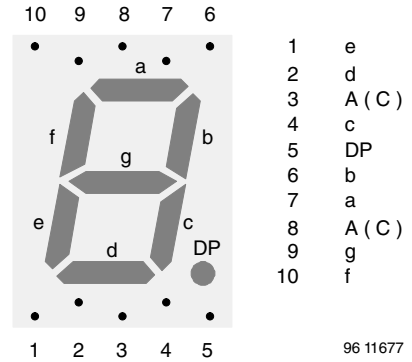
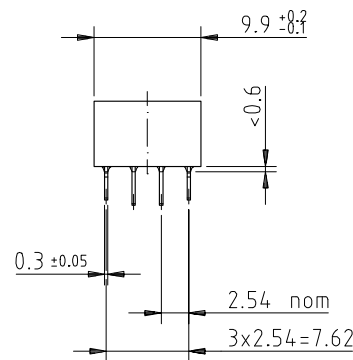
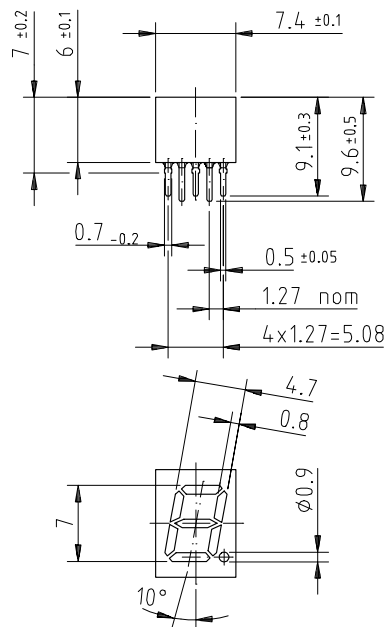

Fig. 18 - TDS.11..

PACKAGE DIMENSIONS FOR TDS.11.. in millimeters



Drawing-No.: 6.544-5083.01-4
 Issue: 1; 21.11.95
 95 11342

Ozone Depleting Substances Policy Statement

It is the policy of **Vishay Semiconductor GmbH** to

1. Meet all present and future national and international statutory requirements.
2. Regularly and continuously improve the performance of our products, processes, distribution and operating systems with respect to their impact on the health and safety of our employees and the public, as well as their impact on the environment.

It is particular concern to control or eliminate releases of those substances into the atmosphere which are known as ozone depleting substances (ODSs).

The Montreal Protocol (1987) and its London Amendments (1990) intend to severely restrict the use of ODSs and forbid their use within the next ten years. Various national and international initiatives are pressing for an earlier ban on these substances.

Vishay Semiconductor GmbH has been able to use its policy of continuous improvements to eliminate the use of ODSs listed in the following documents.

1. Annex A, B and list of transitional substances of the Montreal Protocol and the London Amendments respectively
2. Class I and II ozone depleting substances in the Clean Air Act Amendments of 1990 by the Environmental Protection Agency (EPA) in the USA
3. Council Decision 88/540/EEC and 91/690/EEC Annex A, B and C (transitional substances) respectively.

Vishay Semiconductor GmbH can certify that our semiconductors are not manufactured with ozone depleting substances and do not contain such substances.

**We reserve the right to make changes to improve technical design
and may do so without further notice.**

Parameters can vary in different applications. All operating parameters must be validated for each customer application by the customer. Should the buyer use Vishay Semiconductors products for any unintended or unauthorized application, the buyer shall indemnify Vishay Semiconductors against all claims, costs, damages, and expenses, arising out of, directly or indirectly, any claim of personal damage, injury or death associated with such unintended or unauthorized use.

Vishay Semiconductor GmbH, P.O.B. 3535, D-74025 Heilbronn, Germany
Telephone: 49 (0)7131 67 2831, Fax number: 49 (0)7131 67 2423

Pin Connections 7 mm

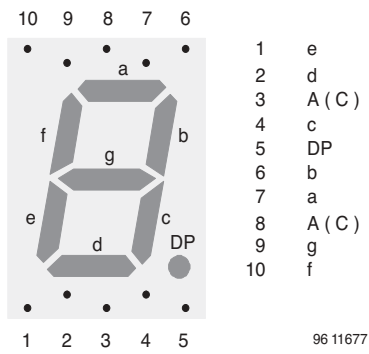

Ozone Depleting Substances Policy Statement

It is the policy of **Vishay Semiconductor GmbH** to

1. Meet all present and future national and international statutory requirements.
2. Regularly and continuously improve the performance of our products, processes, distribution and operating systems with respect to their impact on the health and safety of our employees and the public, as well as their impact on the environment.

It is particular concern to control or eliminate releases of those substances into the atmosphere which are known as ozone depleting substances (ODSs).

The Montreal Protocol (1987) and its London Amendments (1990) intend to severely restrict the use of ODSs and forbid their use within the next ten years. Various national and international initiatives are pressing for an earlier ban on these substances.

Vishay Semiconductor GmbH has been able to use its policy of continuous improvements to eliminate the use of ODSs listed in the following documents.

1. Annex A, B and list of transitional substances of the Montreal Protocol and the London Amendments respectively
2. Class I and II ozone depleting substances in the Clean Air Act Amendments of 1990 by the Environmental Protection Agency (EPA) in the USA
3. Council Decision 88/540/EEC and 91/690/EEC Annex A, B and C (transitional substances) respectively.

Vishay Semiconductor GmbH can certify that our semiconductors are not manufactured with ozone depleting substances and do not contain such substances.

**We reserve the right to make changes to improve technical design
and may do so without further notice.**

Parameters can vary in different applications. All operating parameters must be validated for each customer application by the customer. Should the buyer use Vishay Semiconductors products for any unintended or unauthorized application, the buyer shall indemnify Vishay Semiconductors against all claims, costs, damages, and expenses, arising out of, directly or indirectly, any claim of personal damage, injury or death associated with such unintended or unauthorized use.

Vishay Semiconductor GmbH, P.O.B. 3535, D-74025 Heilbronn, Germany
Telephone: 49 (0)7131 67 2831, Fax number: 49 (0)7131 67 2423



Disclaimer

ALL PRODUCT, PRODUCT SPECIFICATIONS AND DATA ARE SUBJECT TO CHANGE WITHOUT NOTICE TO IMPROVE RELIABILITY, FUNCTION OR DESIGN OR OTHERWISE.

Vishay Intertechnology, Inc., its affiliates, agents, and employees, and all persons acting on its or their behalf (collectively, "Vishay"), disclaim any and all liability for any errors, inaccuracies or incompleteness contained in any datasheet or in any other disclosure relating to any product.

Vishay makes no warranty, representation or guarantee regarding the suitability of the products for any particular purpose or the continuing production of any product. To the maximum extent permitted by applicable law, Vishay disclaims (i) any and all liability arising out of the application or use of any product, (ii) any and all liability, including without limitation special, consequential or incidental damages, and (iii) any and all implied warranties, including warranties of fitness for particular purpose, non-infringement and merchantability.

Statements regarding the suitability of products for certain types of applications are based on Vishay's knowledge of typical requirements that are often placed on Vishay products in generic applications. Such statements are not binding statements about the suitability of products for a particular application. It is the customer's responsibility to validate that a particular product with the properties described in the product specification is suitable for use in a particular application. Parameters provided in datasheets and/or specifications may vary in different applications and performance may vary over time. All operating parameters, including typical parameters, must be validated for each customer application by the customer's technical experts. Product specifications do not expand or otherwise modify Vishay's terms and conditions of purchase, including but not limited to the warranty expressed therein.

Except as expressly indicated in writing, Vishay products are not designed for use in medical, life-saving, or life-sustaining applications or for any other application in which the failure of the Vishay product could result in personal injury or death. Customers using or selling Vishay products not expressly indicated for use in such applications do so at their own risk. Please contact authorized Vishay personnel to obtain written terms and conditions regarding products designed for such applications.

No license, express or implied, by estoppel or otherwise, to any intellectual property rights is granted by this document or by any conduct of Vishay. Product names and markings noted herein may be trademarks of their respective owners.

Material Category Policy

Vishay Intertechnology, Inc. hereby certifies that all its products that are identified as RoHS-Compliant fulfill the definitions and restrictions defined under Directive 2011/65/EU of The European Parliament and of the Council of June 8, 2011 on the restriction of the use of certain hazardous substances in electrical and electronic equipment (EEE) - recast, unless otherwise specified as non-compliant.

Please note that some Vishay documentation may still make reference to RoHS Directive 2002/95/EC. We confirm that all the products identified as being compliant to Directive 2002/95/EC conform to Directive 2011/65/EU.

Vishay Intertechnology, Inc. hereby certifies that all its products that are identified as Halogen-Free follow Halogen-Free requirements as per JEDEC JS709A standards. Please note that some Vishay documentation may still make reference to the IEC 61249-2-21 definition. We confirm that all the products identified as being compliant to IEC 61249-2-21 conform to JEDEC JS709A standards.

Данный компонент на территории Российской Федерации

Вы можете приобрести в компании MosChip.

Для оперативного оформления запроса Вам необходимо перейти по данной ссылке:

<http://moschip.ru/get-element>

Вы можете разместить у нас заказ для любого Вашего проекта, будь то серийное производство или разработка единичного прибора.

В нашем ассортименте представлены ведущие мировые производители активных и пассивных электронных компонентов.

Нашей специализацией является поставка электронной компонентной базы двойного назначения, продукции таких производителей как XILINX, Intel (ex.ALTERA), Vicor, Microchip, Texas Instruments, Analog Devices, Mini-Circuits, Amphenol, Glenair.

Сотрудничество с глобальными дистрибьюторами электронных компонентов, предоставляет возможность заказывать и получать с международных складов практически любой перечень компонентов в оптимальные для Вас сроки.

На всех этапах разработки и производства наши партнеры могут получить квалифицированную поддержку опытных инженеров.

Система менеджмента качества компании отвечает требованиям в соответствии с ГОСТ Р ИСО 9001, ГОСТ РВ 0015-002 и ЭС РД 009

Офис по работе с юридическими лицами:

105318, г.Москва, ул.Щербаковская д.3, офис 1107, 1118, ДЦ «Щербаковский»

Телефон: +7 495 668-12-70 (многоканальный)

Факс: +7 495 668-12-70 (доб.304)

E-mail: info@moschip.ru

Skype отдела продаж:

moschip.ru

moschip.ru_4

moschip.ru_6

moschip.ru_9