

**7-bit 0.25 dB Digital Step Attenuator**
**150 MHz to 4000 MHz**
**GENERAL DESCRIPTION**

This document describes the specification for the F1950 Digital Step Attenuator. The F1950 is part of a family of *Glitch-Free™* DSAs optimized for the demanding requirements of communications Infrastructure. These devices are offered in a compact 4x4 QFN package with 50 Ω impedances for ease of integration into the radio system.

**COMPETITIVE ADVANTAGE**

Digital step attenuators are used in Receivers and Transmitters to provide gain control. The F1950 is a 7-bit step attenuator optimized for these demanding applications. The silicon design has very low insertion loss and low distortion (+65 dBm IP3<sub>I</sub>). The device has pinpoint accuracy and settles to final attenuation value within 400 ns. Most importantly, the F1950 includes IDT's *Glitch-Free™* technology which results in less than 0.6 dB of overshoot ringing during MSB transitions. This is in stark contrast to competing DSAs that *glitch as much as 10 dB* during MSB transitions (see p.10).

- ✓ Lowest insertion loss for best SNR
- ✓ *Glitch-Free™* when transitioning – won't damage PA or ADC
- ✓ Extremely accurate with low distortion

**APPLICATIONS**

- Base Station 2G, 3G, 4G, TDD radiocards
- Repeaters and E911 systems
- Digital Pre-Distortion
- Point to Point Infrastructure
- Public Safety Infrastructure
- WIMAX Receivers and Transmitters
- Military Systems, JTRS radios
- RFID handheld and portable readers
- Cable Infrastructure

**PART# MATRIX**

Part#	Freq range	Resolution / Range	Control	IL	Pinout
F1950	150 - 4000	0.25 / 31.75	Parallel & Serial	-1.3	PE
F1951	100 - 4000	0.50 / 31.5	Serial Only	-1.2	HITT
F1952	100 - 4000	0.50 / 15.5	Serial Only	-0.9	HITT

**FEATURES**

- *Glitch-Free™*, < 0.6 dB transient overshoot
- Spurious Free Design
- 3V to 5V supply
- Attenuation Error < 0.3 dB @ 2 GHz
- Low Insertion Loss < 1.3 dB @ 2 GHz
- Excellent Linearity +65 dBm IP3<sub>I</sub>
- Fast settling time, < 400 ns
- Class 2 JEDEC ESD (> 2kV HBM)
- Serial & Parallel Interface 31.75 dB Range
- 4 x 4 mm Thin QFN 24 pin package

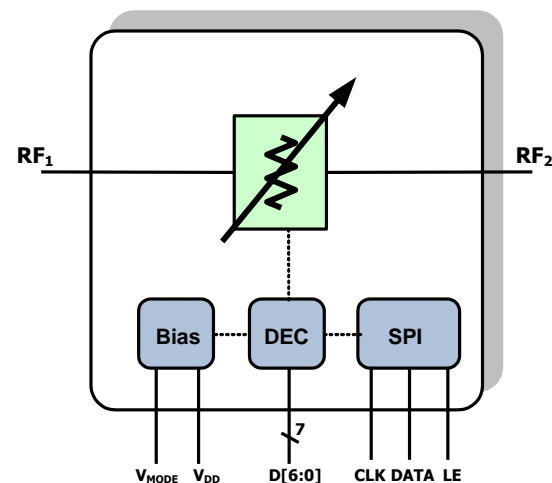
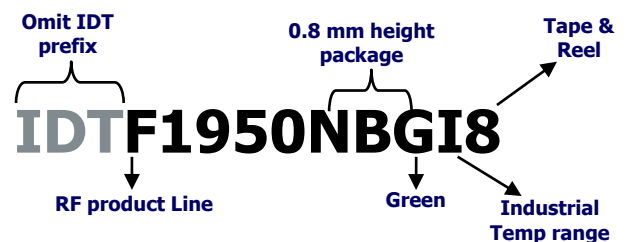
**DEVICE BLOCK DIAGRAM**

**ORDERING INFORMATION**

**7-bit 0.25 dB Digital Step Attenuator****150 MHz to 4000 MHz****ABSOLUTE MAXIMUM RATINGS**

$V_{DD}$ to GND	-0.3 V to +5.5 V
D[6:0], DATA, CLK, LE, $V_{MODE}$	-0.3 V to 3.6 V
RF Input Power (RF1, RF2) calibration and testing	+29 dBm
RF Input Power (RF1, RF2) continuous RF operation	+23 dBm
$\theta_{JA}$ (Junction – Ambient)	+50 °C/W
$\theta_{JC}$ (Junction – Case) The Case is defined as the exposed paddle	+3 °C/W
Operating Temperature Range (Case Temperature)	$T_c = -40\text{ °C to }+100\text{ °C}$
Maximum Junction Temperature	140 °C
Storage Temperature Range	-65 °C to +150 °C
Lead Temperature (soldering, 10s)	+260 °C

**7-bit 0.25 dB Digital Step Attenuator**
**150 MHz to 4000 MHz**
**F1950 SPECIFICATION (31.75 dB Range)**

 Specifications apply at  $V_{DD} = +3.3V$ ,  $f_{RF} = 2000MHz$ , and  $T_C = +25^{\circ}C$ , EVkit losses are de-embedded (see p. 17) for spec purposes

Parameter	Comment	Sym.	Min	Typical	Max	Units						
Logic Input High	CLK, LE, DATA, D[6:0], $V_{MODE}$	$V_{IH}$	<b>2.3</b>		3.6	V						
Logic Input Low	CLK, LE, DATA, D[6:0], $V_{MODE}$	$V_{IL}$			<b>0.7</b>	V						
Logic Current	$V_{MODE}$	$I_{IH}, I_{IL}$	<b>-5</b>		<b>+5</b>	$\mu A$						
Supply Voltage(s)	Main Supply	$V_{DD}$	3.0	3.30	5.25	V						
Supply Current	Total	$I_{DD}$		<b>0.25</b>	<b>0.5<sup>1</sup></b>	mA						
Temperature Range	Operating Range (Case)	$T_C$	-40		+100	$^{\circ}C$						
Frequency Range	Operating Range	$F_{RF}$	<b>150</b>		<b>4000</b>	MHz						
RF1, RF2 Return Loss	dB(s11), dB(s22)	$S_{11}, S_{22}$		-22		dB						
Minimum Attenuation	D[6:0] = [0000000]	$A_{MIN}$ or $IL$		<b>1.3</b>	<b>1.9</b>	dB						
Maximum Attenuation	D[6:0] = [1111111]	$A_{MAX}$	32.6	33.0		dB						
Minimum Gain Step	Least Significant Bit	<b>LSB</b>		0.25		dB						
Phase Delta	Phase change $A_{MIN}$ vs. $A_{MAX}$	$\Phi_{\Delta}$		34		deg						
Differential Non-Linearity	Max error between adjacent steps	<b>DNL</b>		0.10		dB						
Integral Non-Linearity	Max Error vs. line ( $A_{MIN}$ ref) to 13.75 dB ATTN	<b>INL<sub>1</sub></b>		<b>0.02</b>	<b>0.30</b>	dB						
Integral Non-Linearity	Max Error vs. line ( $A_{MIN}$ ref) to 31.75 dB ATTN	<b>INL<sub>2</sub></b>		0.27	0.45	dB						
Input IP3	D[6:0] = [0000000] = $A_{MIN}$	<b>IP3<sub>1</sub></b>	+60 <sup>2</sup>	+63		dBm						
	D[6:0] = [0111111] = $A_{15.75}$	<b>IP3<sub>2</sub></b>	+59	+61								
	D[6:0] = [1111111] = $A_{MAX}$	<b>IP3<sub>3</sub></b>	+57	+61								
0.1 dB Compression <i>Please note ABS MAX Input power on Page 2</i>	<ul style="list-style-type: none"> <li>D[6:0] = [0001010] = <math>A_{2.5}</math></li> <li>Baseline <math>P_{IN} = 20</math> dBm</li> </ul>	<b>P<sub>0.1</sub></b>		27.5		dBm						
		Settling Time	<ul style="list-style-type: none"> <li>Start LE rising edge &gt; <math>V_{IH}</math></li> <li>End +/-0.10 dB Pout settling</li> <li>15.75 – 16.00 transition</li> </ul>	<b>T<sub>LSB</sub></b>	400		ns					
Serial Clock Speed	SPI 3 wire bus							<b>F<sub>CLK</sub></b>		<b>20</b>	<b>50</b>	MHz
Parallel to Serial Setup	SPI 3 wire bus							<b>A</b>	<b>100</b>			ns
Serial Data Hold Time	SPI 3 wire bus	<b>B</b>	<b>10</b>			ns						
LE delay from final serial clock rising edge	SPI 3 wire bus	<b>C</b>	<b>10</b>			ns						

**SPECIFICATION NOTES:**

- 1 – Items in min/max columns in **bold italics** are Guaranteed by Test
- 2 – All other Items in min/max columns are Guaranteed by Design Characterization

**SERIAL CONTROL MODE**

Serial mode is selected by floating  $V_{MODE}$  (pin3) or pulling it to a voltage  $> V_{IH}$ . In serial mode data is clocked in LSB first. Note the timing diagram below.

**Note** – The F1950 includes a CLK inhibit feature designed to minimize sensitivity to CLK bus noise when the device is not being programmed. When Latch enable is high ( $> V_{IH}$ ), the CLK input is disabled and DATA will not be clocked into the shift register. It is recommended that LE be pulled high ( $> V_{IH}$ ) when the device is not being programmed.

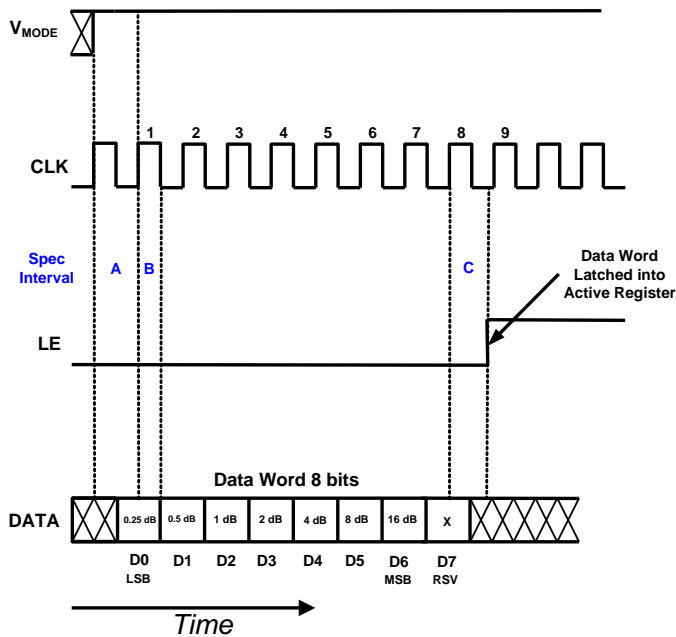
**SERIAL REGISTER TIMING DIAGRAM:** (Note the Timing Spec Intervals in **Blue**)

**SERIAL MODE DEFAULT CONDITION:**

When the device is powered up it will default to the **Maximum Attenuation** setting as described below:

**Note that for the F1950 in all cases (High or 1) = Attenuation Stepped IN. (0 or Low) = Attenuation Stepped OUT.**

**Default Register Settings**

0	1	1	1	1	1	1	1
D7 RSV	D6 MSB	D5	D4	D3	D2	D1	D0 LSB

**SERIAL MODE TIMING TABLE:**

Interval Symbol	Description	Min Spec	Max Spec	Units
A	Parallel to Serial Setup Time	100		ns
B	Serial Data Hold Time	10		ns
C	LE delay from final serial clock rising edge	10		ns

## PARALLEL CONTROL MODE

The user has the option of running in one of two parallel modes: *Direct Parallel Mode* or *Latched Parallel Mode*.

### DIRECT PARALLEL MODE:

Direct Parallel Mode is selected when  $V_{MODE}$  (pin 3) is  $< V_{IL}$  and LE (pin 16) is  $> V_{IH}$ . In this mode the device will immediately react to any voltage changes to the parallel control pins [pins 19, 20, 21, 22, 23, 24, 1]. Use direct parallel mode for the fastest settling time.

### LATCHED PARALLEL MODE:

Latched Parallel Mode is selected when  $V_{MODE}$  (pin 3) is  $< V_{IL}$  and LE (pin 16) is toggled from  $< V_{IL}$  to  $> V_{IH}$ .

To utilize Latched Parallel Mode:

- Set LE  $< V_{IL}$
- Adjust pins [19, 20, 21, 22, 23, 24, 1] to the desired attenuation setting. (Note the device will not react to these pins while LE  $< V_{IL}$ .)
- Pull LE  $> V_{IH}$ . The device will then transition to the attenuation settings reflected by these pins.

Latched Parallel Mode implies a default state for when the device is powered up with  $V_{MODE} < V_{IL}$  and LE  $< V_{IL}$ . In this case the default setting is MAXIMUM Attenuation.

### LATCHED PARALLEL MODE TIMING DIAGRAM: (Note the Timing Spec Intervals in Blue)

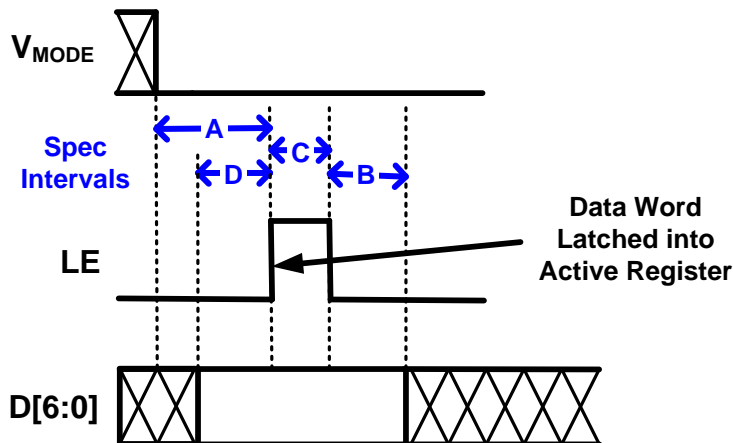

### LATCHED PARALLEL MODE TIMING TABLE:

Interval Symbol	Description	Min Spec	Max Spec	Units
A	Serial to Parallel Mode Setup Time	100		ns
B	Parallel Data Hold Time	10		ns
C	LE minimum pulse width	10		ns
D	Parallel Data Setup Time	10		ns

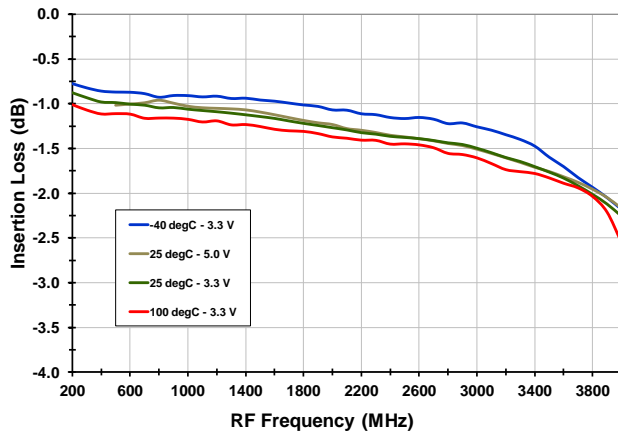
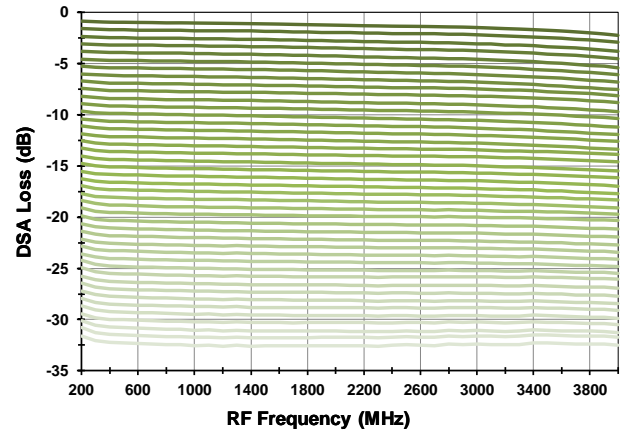
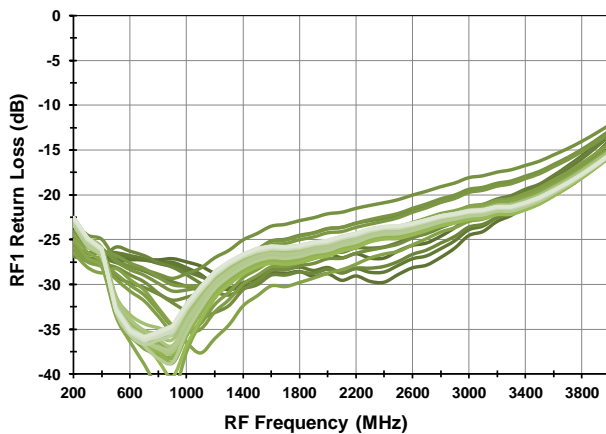
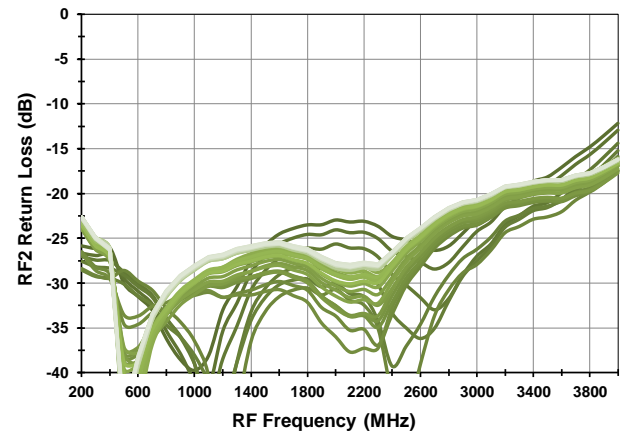
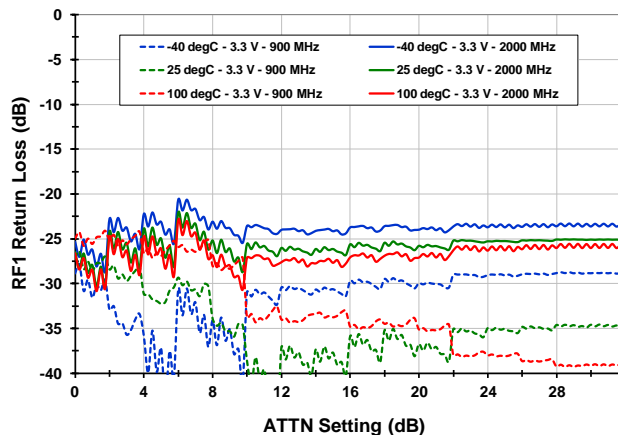
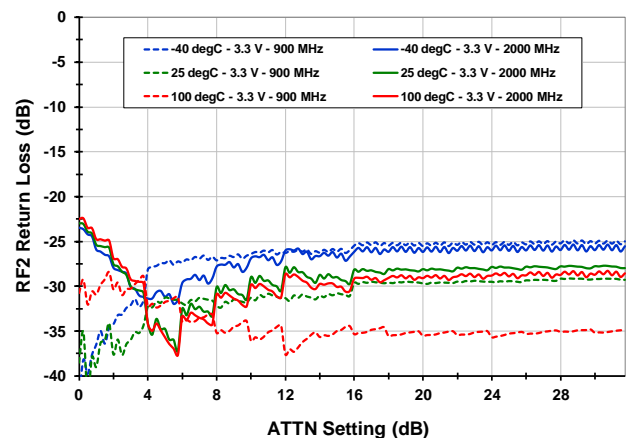
**TYPICAL OPERATING PARAMETRIC CURVES (EVKit loss de-embedded unless otherwise noted)**
**Insertion Loss vs. Frequency [A<sub>MIN</sub>]**

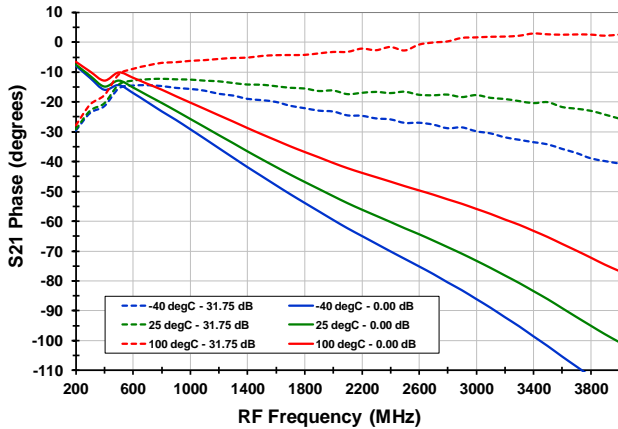
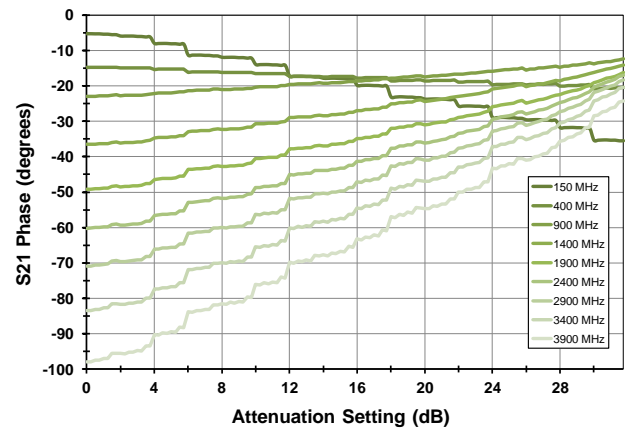
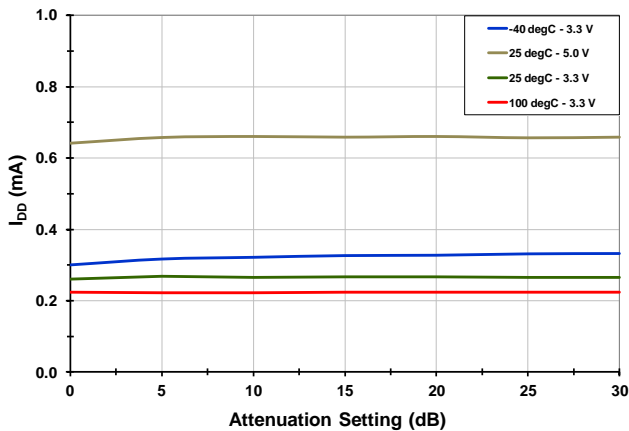
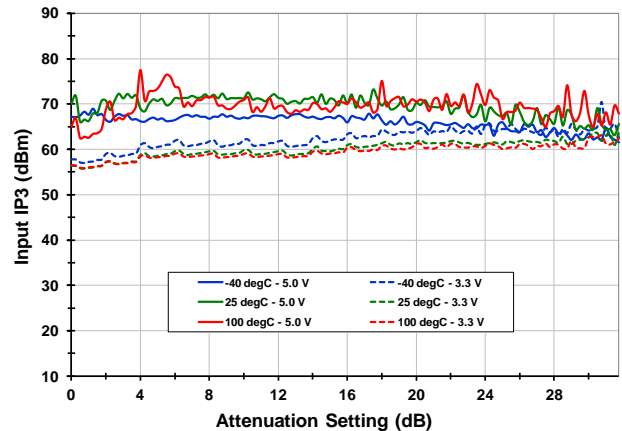
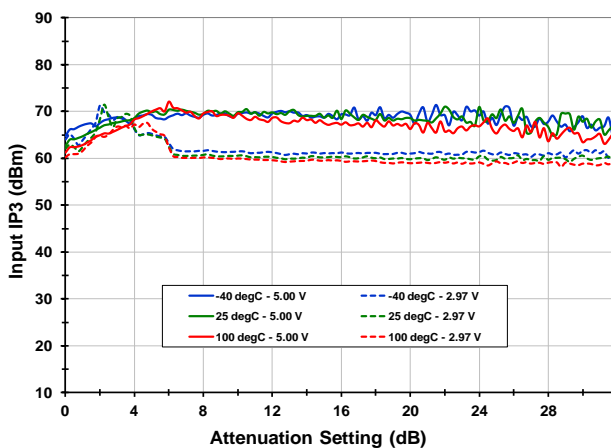
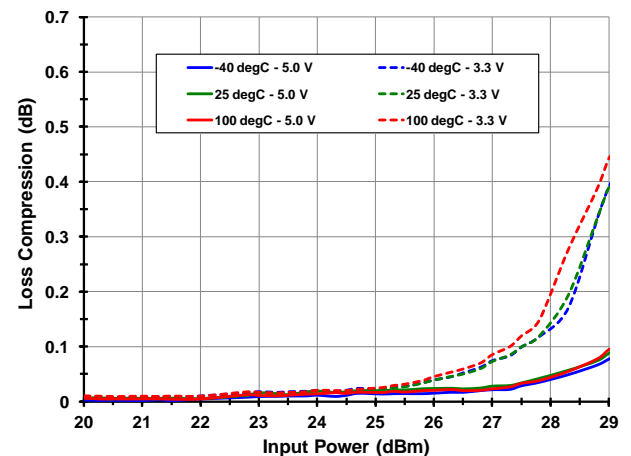
**Attenuation vs. Freq [T<sub>CASE</sub> = +25C, 0.75 dB steps]**

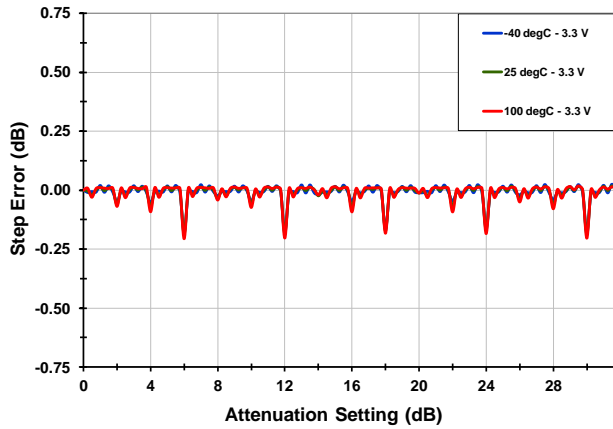
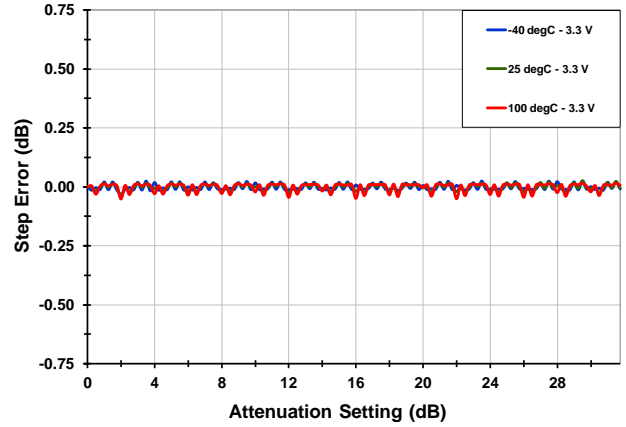
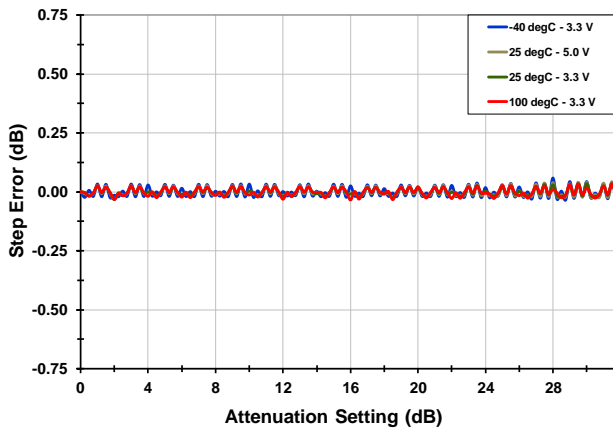
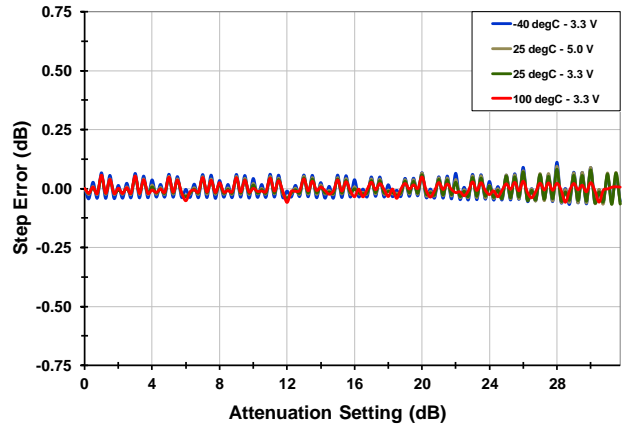
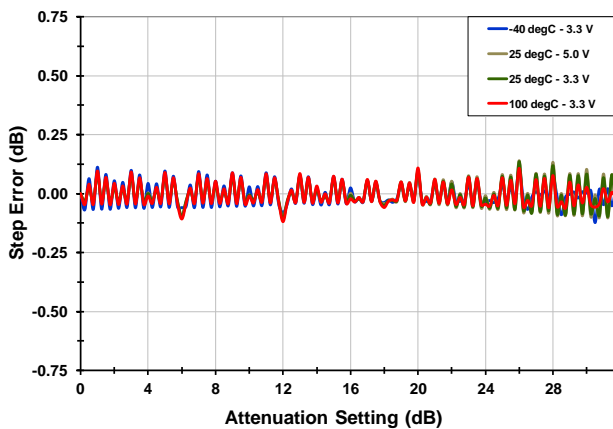
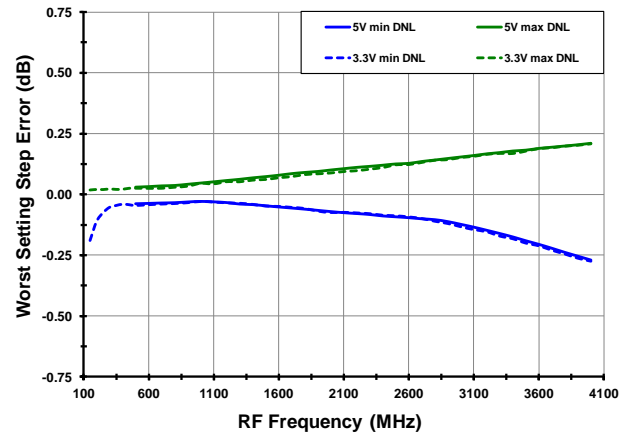
**S<sub>11</sub> vs. Frequency [T<sub>CASE</sub> = +25C, 0.75 dB steps]**

**S<sub>22</sub> vs. Frequency [T<sub>CASE</sub> = +25C, 0.75 dB steps]**

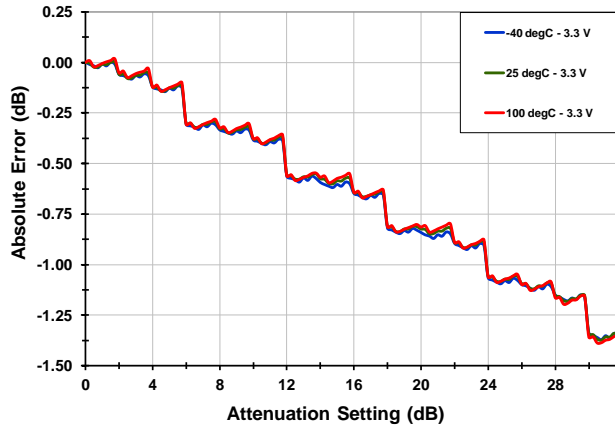
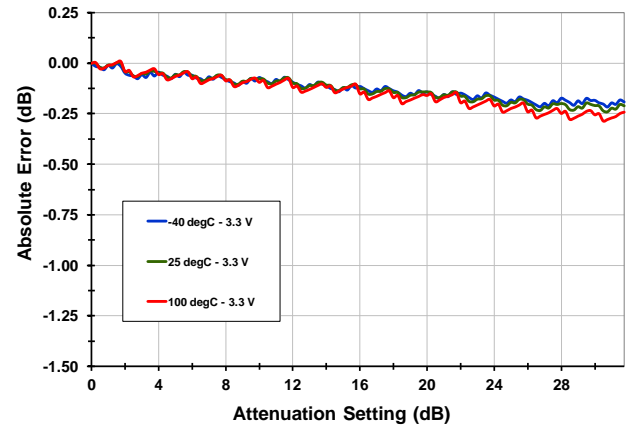
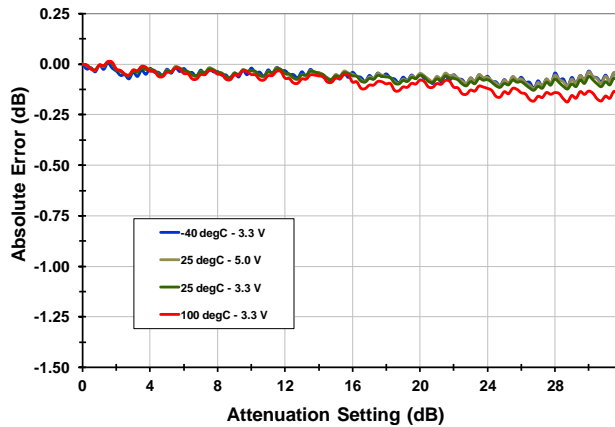
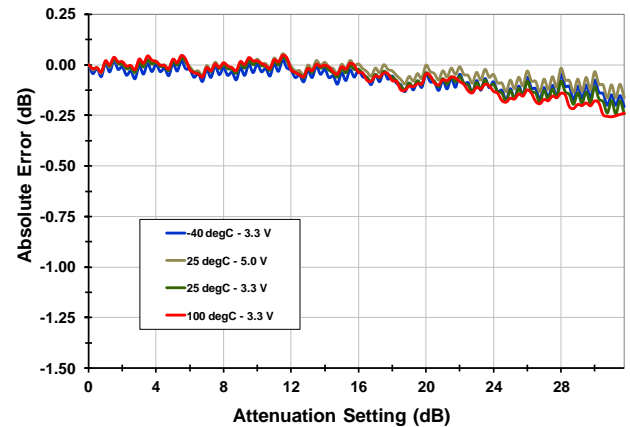
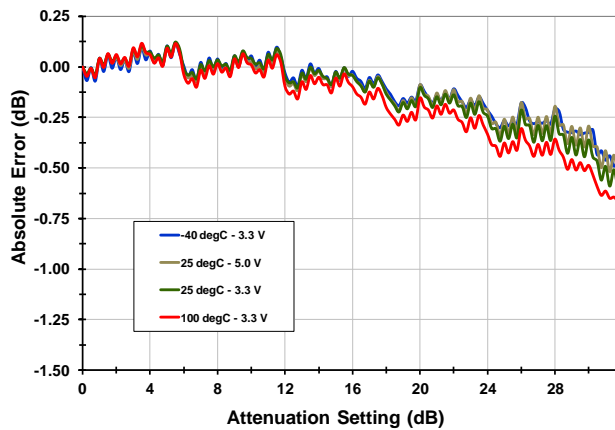
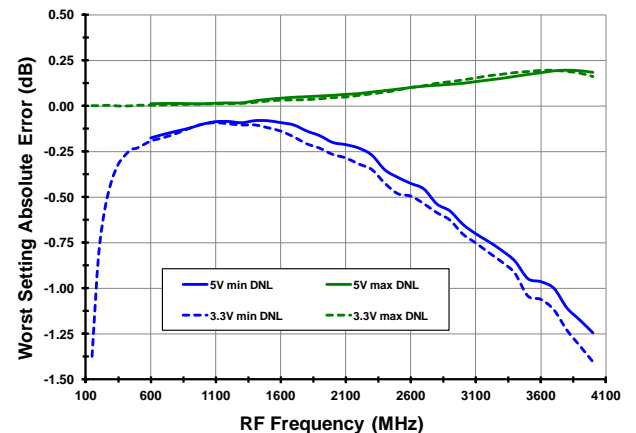
**S<sub>11</sub> vs. Attenuation State**

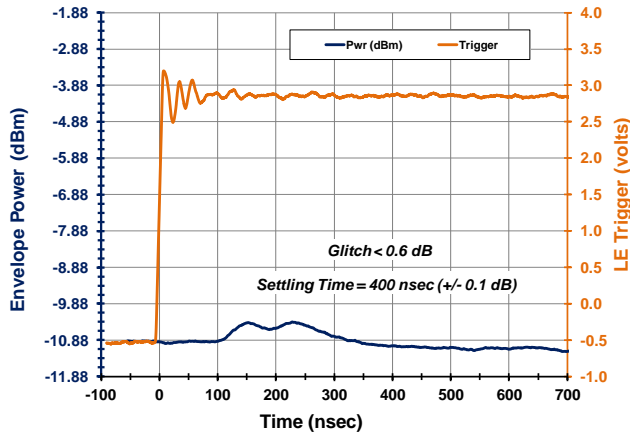
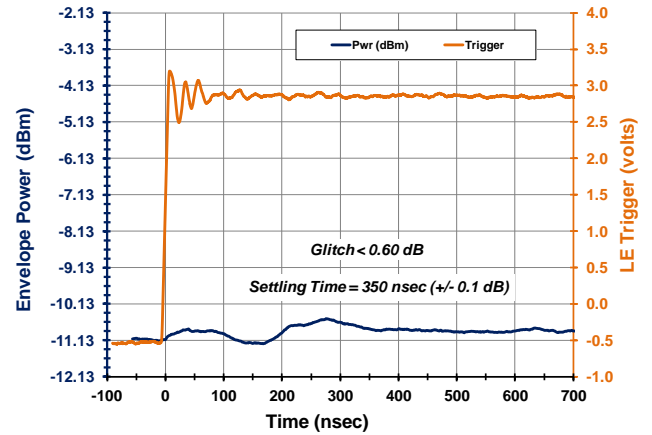
**S<sub>22</sub> vs. Attenuation State**

**TOCS CONTINUED (-2-)**
**Phase vs. Frequency**

**Phase vs. Attenuation Setting**

**Supply Current I<sub>DD</sub>**

**Input IP<sub>3</sub> [f<sub>RF</sub> = 900 MHz]**

**Input IP<sub>3</sub> [f<sub>RF</sub> = 1900 MHz]**

**Compression [f<sub>RF</sub> = 2000 MHz, ATTN = 2.5 dB]**

**TOCS CONTINUED (-3-)**
**DNL [150 MHz]**

**DNL [450 MHz]**

**DNL [900 MHz]**

**DNL [1900 MHz]**

**DNL [2800 MHz]**

**Worst Setting DNL**



**TOCS CONTINUED (-4-)**
**INL [150 MHz]**

**INL [450 MHz]**

**INL [900 MHz]**

**INL [1900 MHz]**

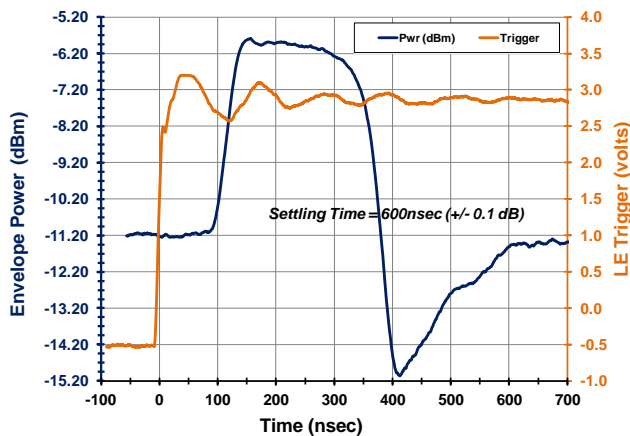
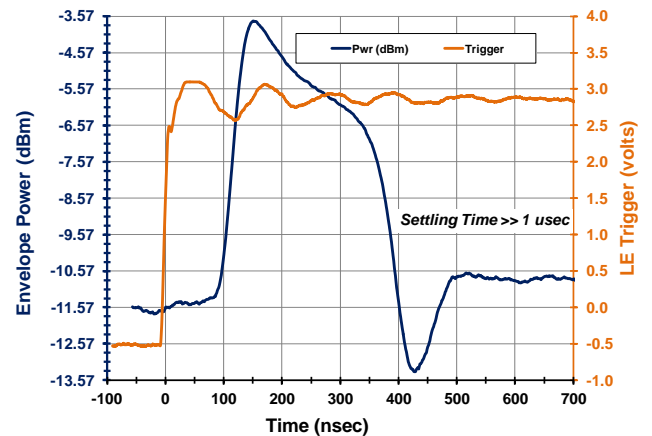
**INL [2800 MHz]**

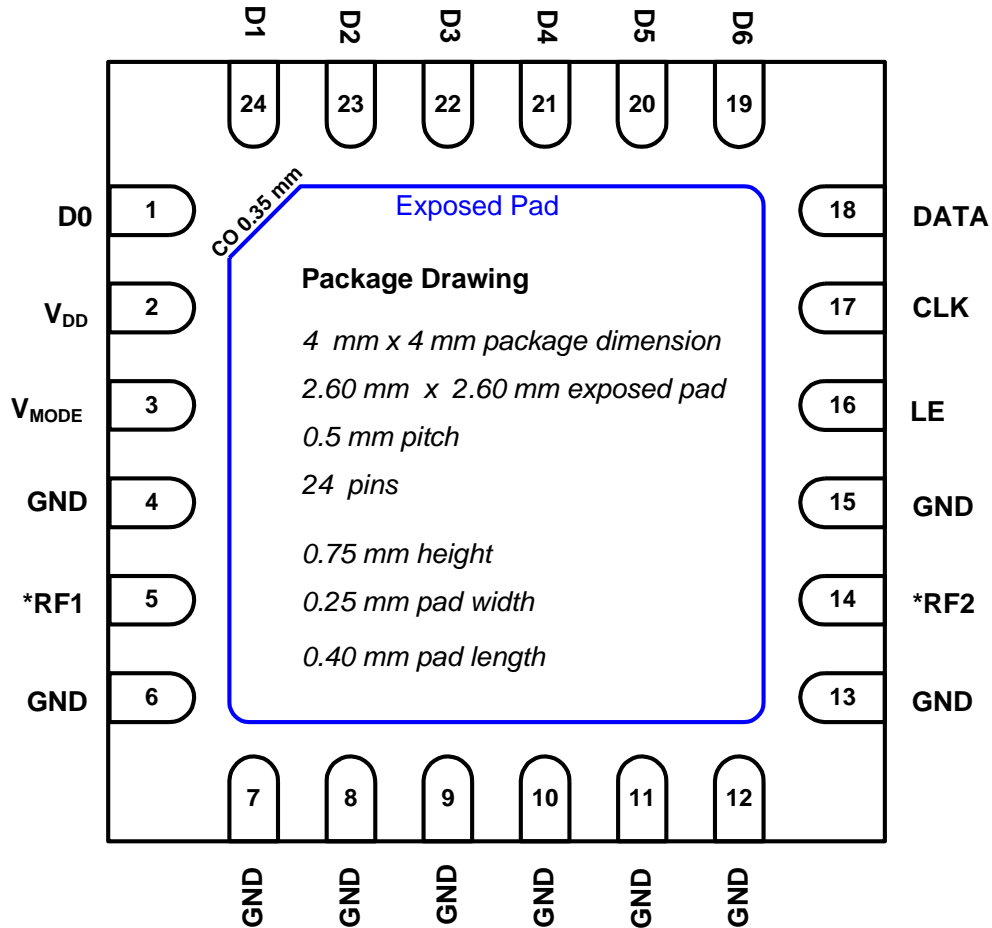
**Worst Setting INL**

**TOCS CONTINUED (-5-) [ $f_{RF} = 900$  MHz]**
**Transient [ 15.75 to 16.00 (MSB+) 3.3V F1950 ]**

**Transient [ 16.00 to 15.75 (MSB-) 5.0V F1950 ]**

The graphs above show the transient overshoot and settling time performance for both the MSB+ and MSB- cases for the F1950. The device settles very quickly ( $\sim 400$ ) nsec with benign ( $\sim 0.5$ ) dB overshoot.

The graphs below show the transient overshoot and settling time performance for a popular competing DSA. *Note the overshoot/undershoot excursion of almost 10 dB and the very long settling time.* For the MSB- case, the settling time is off the scale,  $\sim 3$  usec.

**Transient [ 15.75 to 16.00 (MSB+) Standard DSA ]**

**Transient [ 16.00 to 15.75 (MSB-) Standard DSA ]**

**PIN DIAGRAM (F1950)**

*\* Device is RF Bi-Directional*

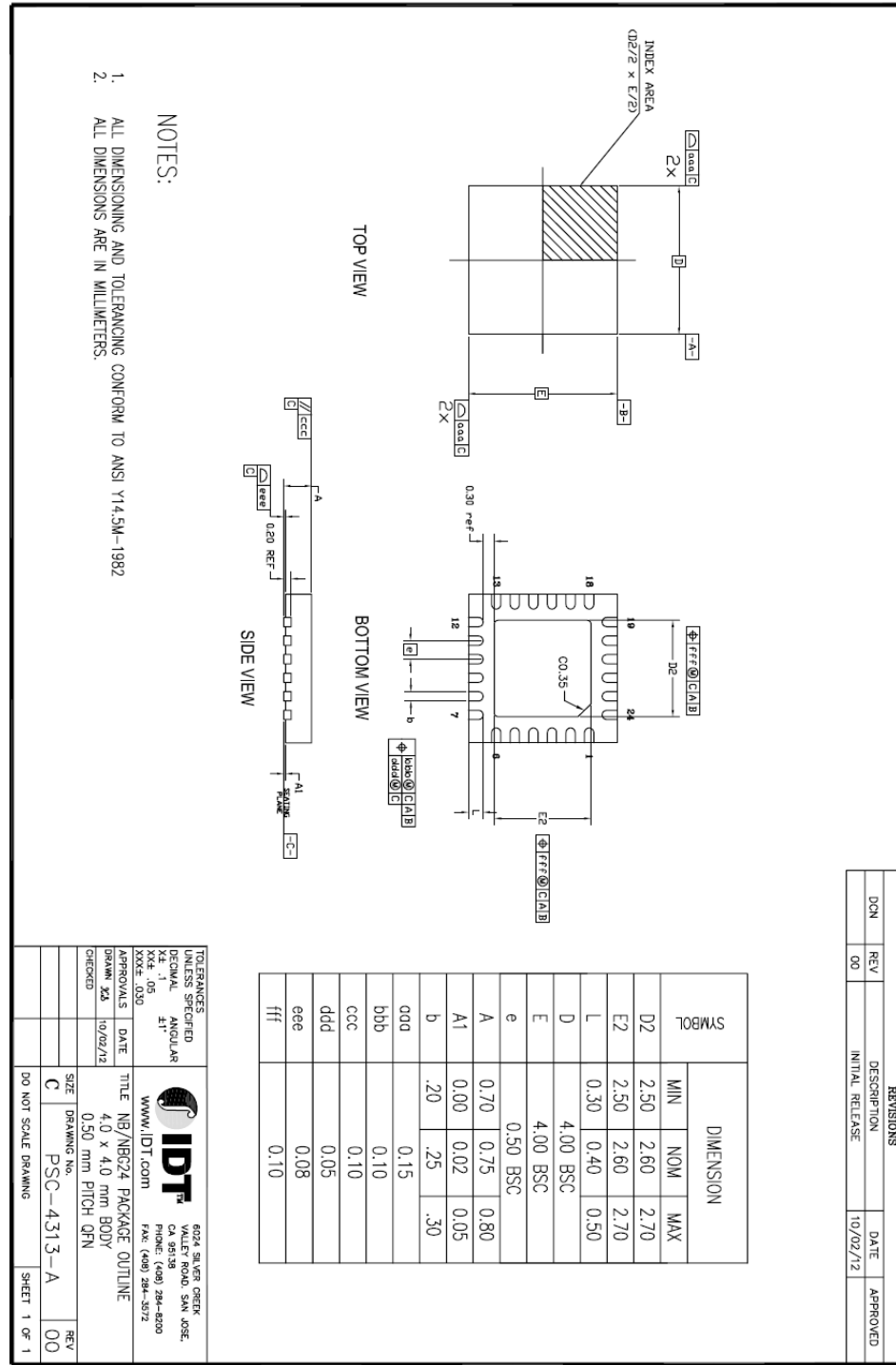

**PACKAGE DRAWING (4x4 24 PIN)**



**PIN DESCRIPTIONS**

Pin #	Pin Name	Pin Function
1	D0	Parallel Control – 0.25 dB attenuation step. Pull high for 0.25 dB Attenuation.
2	V <sub>DD</sub>	Main Supply. Use 3.3V or 5V. Current is < 1 mA.
3	V <sub>MODE</sub>	Pull low for parallel mode. Pull high or leave unconnected for serial mode.
4	GND	Connect directly to paddle ground or as close as possible to pin with thru via.
5	RF1	Device RF input or output (bi-directional). Must AC couple to this pin.
6	GND	Connect directly to paddle ground or as close as possible to pin with thru via.
7	GND	Connect directly to paddle ground or as close as possible to pin with thru via.
8	GND	Connect directly to paddle ground or as close as possible to pin with thru via.
9	GND	Connect directly to paddle ground or as close as possible to pin with thru via.
10	GND	Connect directly to paddle ground or as close as possible to pin with thru via.
11	GND	Connect directly to paddle ground or as close as possible to pin with thru via.
12	GND	Connect directly to paddle ground or as close as possible to pin with thru via.
13	GND	Connect directly to paddle ground or as close as possible to pin with thru via.
14	RF2	Device RF input or output (bi-directional). Must AC couple to this pin.
15	GND	Connect directly to paddle ground or as close as possible to pin with thru via.
16	LE	Latch Enable. Serial Data latched into active register on rising edge.
17	CLK	Serial Clock Input
18	DATA	Serial Data Input
19	D6	Parallel Control – 16 dB attenuation step. Pull high for 16 dB Attenuation.
20	D5	Parallel Control – 8 dB attenuation step. Pull high for 8 dB Attenuation.
21	D4	Parallel Control – 4 dB attenuation step. Pull high for 4 dB Attenuation.
22	D3	Parallel Control – 2 dB attenuation step. Pull high for 2 dB Attenuation.
23	D2	Parallel Control – 1 dB attenuation step. Pull high for 1 dB Attenuation.
24	D1	Parallel Control – 0.5 dB attenuation step. Pull high for 0.5 dB Attenuation.
EP	Exposed Paddle	Connect to Ground with multiple vias for good thermal relief.

**EVKIT SCHEMATIC**

The diagram below describes the recommended applications / EVkit circuit:

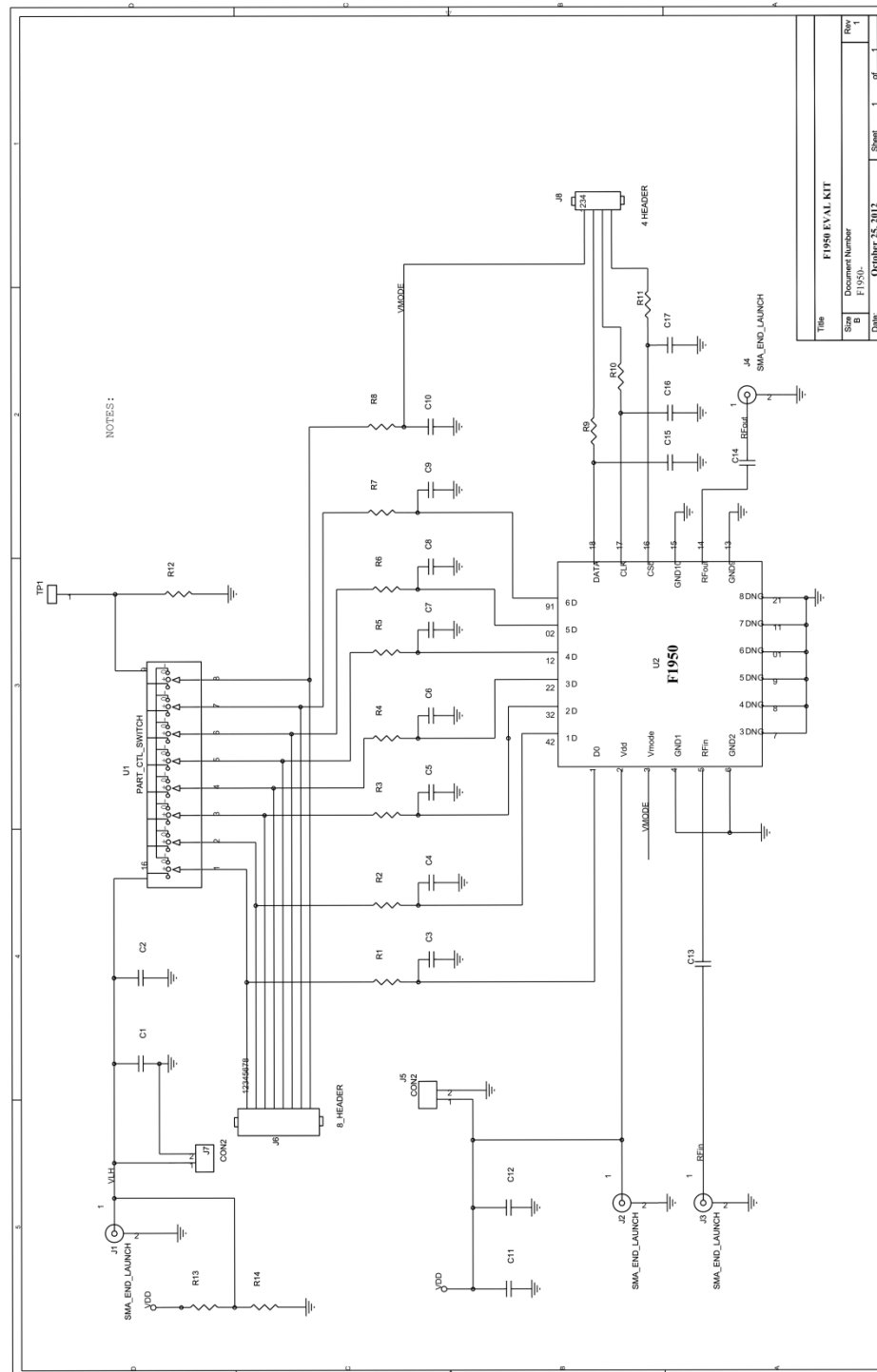

**EVKIT OPERATION** (Email: [RFsupport@IDT.com](mailto:RFsupport@IDT.com) to request an EVkit, Serial Control HW/SW, or TRL cal board)

The picture and graphic below describe how to operate the EVkit

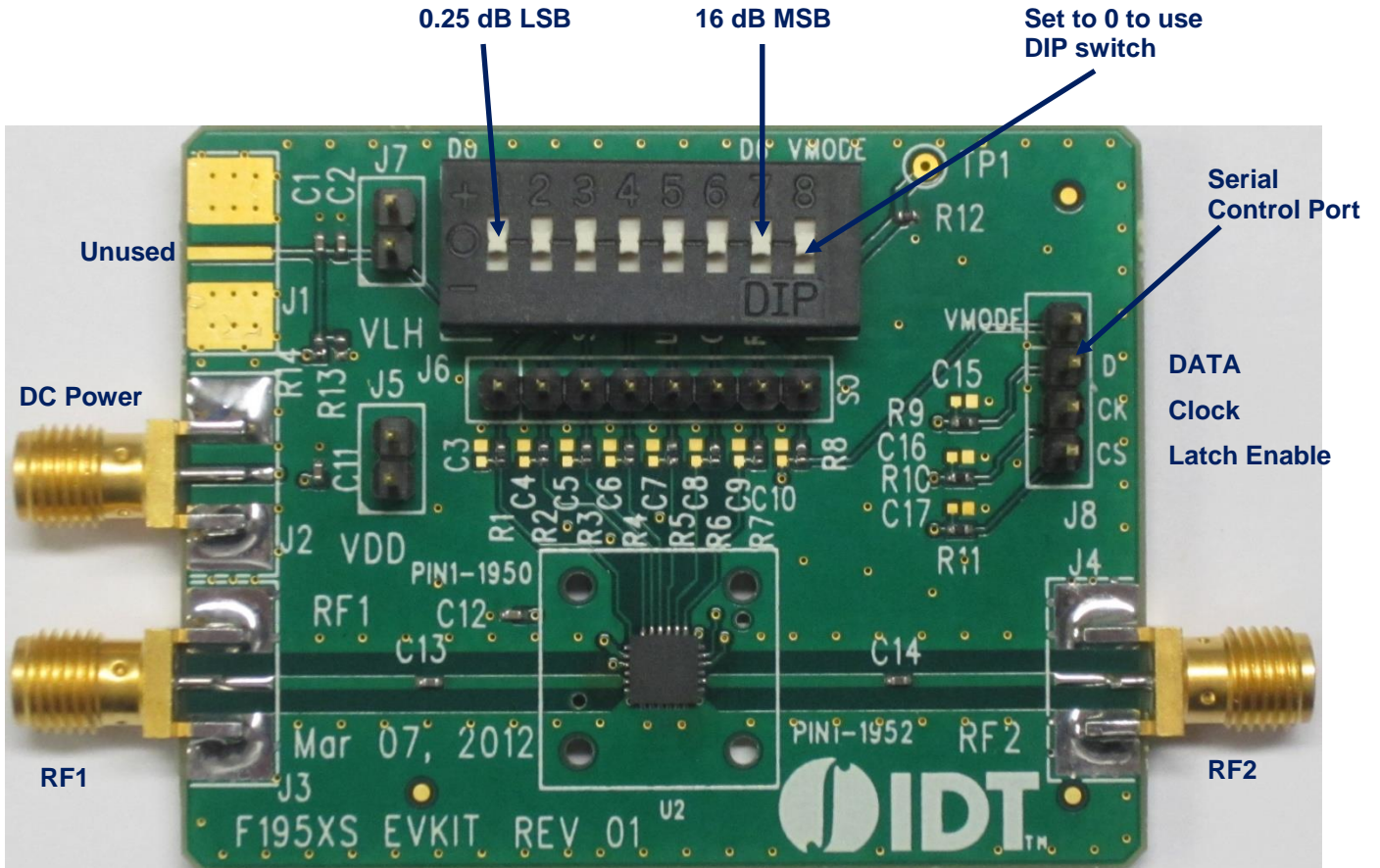

**EVKIT BOM**
*F1950 BOM Rev 02 PCB Rev 01*

Item #	Value	Size	Desc	Mfr. Part #	Mfr.	Part Reference	Qty
1	1000pF	0402	CAP CER 1000PF 50V C0G 0402	GRM1555C1H102JA01D	MURATA	C13,14	2
2	10nF	0402	CAP CER 10000PF 16V 10% X7R 0402	GRM155R71C103KA01D	MURATA	C2,12	2
3	0.1uF	0402	CAP CER 0.1UF 16V 10% X7R 0402	GRM155R71C104KA88D	MURATA	C1,11	2
4	Header 2 Pin	TH 2	CONN HEADER VERT SGL 2POS GOLD	961102-6404-AR	3M	J5,7	2
5	Header 4 Pin	TH 4	CONN HEADER VERT SGL 4POS GOLD	961104-6404-AR	3M	J8	1
6	Header 8 Pin	TH 8	CONN HEADER VERT SGL 8POS GOLD	961108-6404-AR	3M	J6	1
7	SMA_END_LAUNCH	.062	SMA_END_LAUNCH (Small)	142-0711-821	Emerson Johnson	J2,3,4	3
8	0	0402	RES 0.0 OHM 1/10W 0402 SMD	ERJ-2GE0R00X	Panasonic	R1-8,12	9
9	3K	0402	RES 3.00K OHM 1/10W 1% 0402 SMD	ERJ-2RKF3001X	Panasonic	R9-11	3
10	100K	0402	RES 100KOHM 1/10W 0402 SMD	ERJ-2GEJ104X	Panasonic	R13,14	2
11	DIPSwitch	TH 10	8 POSITION DIP SWITCH	KAT1108E	E-Switch	U1	1
12	Digital Step Attenuator		F1950Z	F1950Z	IDT	U2	1
13	PCB		PCB Rev 01	F195XS Eokit Rev 01			1

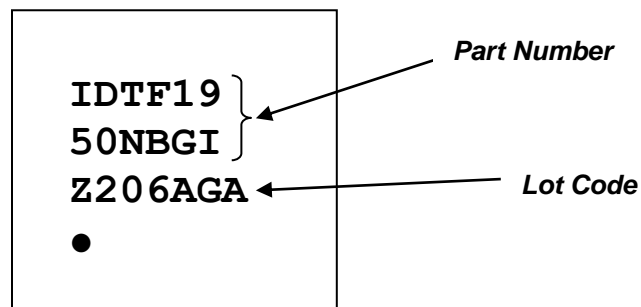
**Total 30**
**TOPMARKINGS**



### **EVKIT THROUGH-REFLECT-LINE (TRL) CALIBRATION**

The “Through-Reflect-Line” (TRL) method [1] is used to de-embed the evaluation board losses from the S-parameter measurements of the F1950. This method requires the use of three standards: a through, a reflection, and a line. The TRL method has the advantage over other calibration methods in that it requires only one of these three standards to be well defined.

The TRL through which is used for the F1950 TRL calibration was constructed identically to the evaluation board, minus the DUT and its corresponding length. Therefore, the through corresponds to a precise zero length connection between the input and output reference planes of the DUT. This through satisfies the requirement of the TRL method that one of the three standards be precisely specified.

The TRL reflection standard used is constructed identically to the input and output lines of the evaluation board, with a short placed at the reference plane of the DUT. In accordance with the TRL method’s requirements, the actual magnitude and phase were not accurately specified, but the phase was known to within 90 degrees and the TRL reflection standard has a magnitude close to one.

The TRL line standard is identical to the TRL through, but with an additional length of 0.8 inches (2 cm). This satisfies the TRL method’s requirement that the TRL be a different length than the TRL through, that it have the same impedance and propagation constant as the through, and that the phase difference between the through and the line be between 20 degrees and 160 degrees. The difference in length yields a phase difference of approximately 20 degrees at 500 MHz, and a phase difference of 160 degrees at 4 GHz.

For characterization of performance from 150 to 500 MHz a separate TRL board with different “Line” length is used.

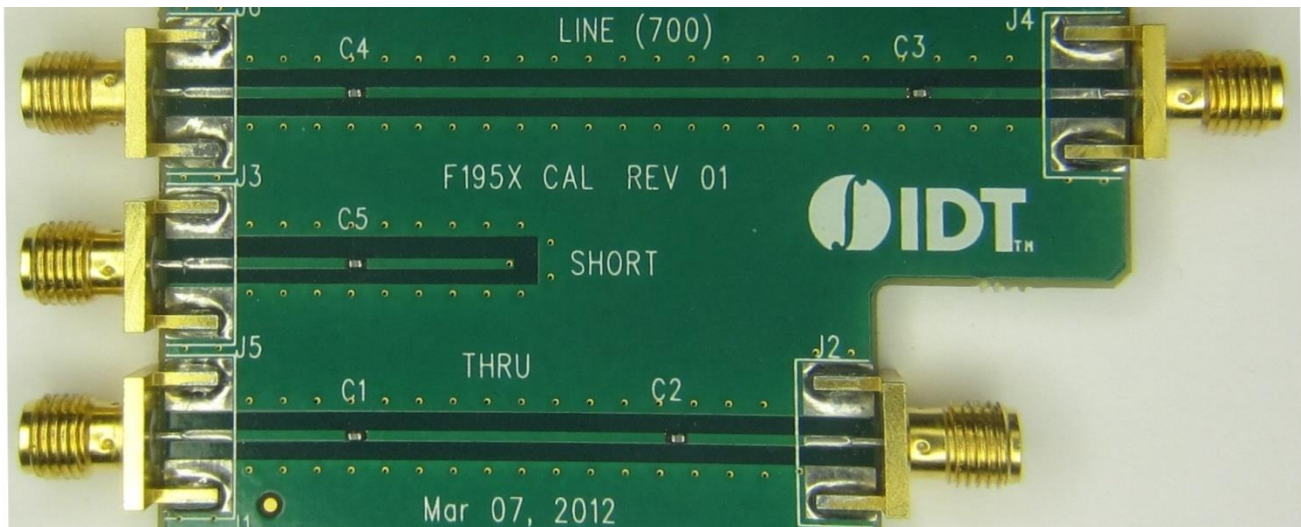

Standards used for F195x TRL calibration

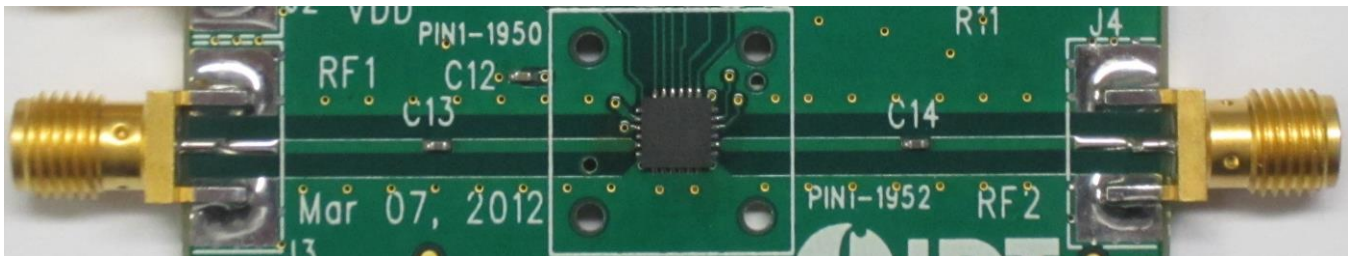

F1950 evaluation circuit

Engen, G.F.; Hoer, C.A.; “Thru-Reflect-Line: An Improved Technique for Calibrating the Dual Six-Port Automatic Network Analyzer,” **IEEE Transactions on Microwave Theory and Techniques**, Volume: 27 Issue:12, pp. 987 – 993, Dec 1979

**REVISION HISTORY SHEET**

<b>Rev</b>	<b>Date</b>	<b>Page</b>	<b>Description of Change</b>
2	2017-Jul-18	2 18	Corrected Absolute Maximum Supply Voltage. Added Revision History Sheet.
1	2013-Jan-15	3 5	Corrected Footer Corrected Maximum Insertion Loss. Added Parallel Latch Diagram.
0	2012-Nov-04		Initial Release

**Corporate Headquarters**6024 Silver Creek Valley Road  
San Jose, CA 95138  
[www.IDT.com](http://www.IDT.com)**Sales**1-800-345-7015 or 408-284-8200  
Fax: 408-284-2775  
[www.IDT.com/go/sales](http://www.IDT.com/go/sales)**Tech Support**[www.IDT.com/go/support](http://www.IDT.com/go/support)

DISCLAIMER Integrated Device Technology, Inc. (IDT) and its affiliated companies (herein referred to as "IDT") reserve the right to modify the products and/or specifications described herein at any time, without notice, at IDT's sole discretion. Performance specifications and operating parameters of the described products are determined in an independent state and are not guaranteed to perform the same way when installed in customer products. The information contained herein is provided without representation or warranty of any kind, whether express or implied, including, but not limited to, the suitability of IDT's products for any particular purpose, an implied warranty of merchantability, or non-infringement of the intellectual property rights of others. This document is presented only as a guide and does not convey any license under intellectual property rights of IDT or any third parties.

IDT's products are not intended for use in applications involving extreme environmental conditions or in life support systems or similar devices where the failure or malfunction of an IDT product can be reasonably expected to significantly affect the health or safety of users. Anyone using an IDT product in such a manner does so at their own risk, absent an express, written agreement by IDT.

Integrated Device Technology, IDT and the IDT logo are trademarks or registered trademarks of IDT and its subsidiaries in the United States and other countries. Other trademarks used herein are the property of IDT or their respective third party owners. For datasheet type definitions and a glossary of common terms, visit [www.idt.com/go/glossary](http://www.idt.com/go/glossary). All contents of this document are copyright of Integrated Device Technology, Inc. All rights reserved.

## Данный компонент на территории Российской Федерации

### Вы можете приобрести в компании MosChip.

Для оперативного оформления запроса Вам необходимо перейти по данной ссылке:

<http://moschip.ru/get-element>

Вы можете разместить у нас заказ для любого Вашего проекта, будь то серийное производство или разработка единичного прибора.

В нашем ассортименте представлены ведущие мировые производители активных и пассивных электронных компонентов.

Нашей специализацией является поставка электронной компонентной базы двойного назначения, продукции таких производителей как XILINX, Intel (ex.ALTERA), Vicor, Microchip, Texas Instruments, Analog Devices, Mini-Circuits, Amphenol, Glenair.

Сотрудничество с глобальными дистрибьюторами электронных компонентов, предоставляет возможность заказывать и получать с международных складов практически любой перечень компонентов в оптимальные для Вас сроки.

На всех этапах разработки и производства наши партнеры могут получить квалифицированную поддержку опытных инженеров.

Система менеджмента качества компании отвечает требованиям в соответствии с ГОСТ Р ИСО 9001, ГОСТ РВ 0015-002 и ЭС РД 009

### Офис по работе с юридическими лицами:

105318, г.Москва, ул.Щербаковская д.3, офис 1107, 1118, ДЦ «Щербаковский»

Телефон: +7 495 668-12-70 (многоканальный)

Факс: +7 495 668-12-70 (доб.304)

E-mail: [info@moschip.ru](mailto:info@moschip.ru)

Skype отдела продаж:

moschip.ru

moschip.ru\_4

moschip.ru\_6

moschip.ru\_9