

# Round Through-Hole LED Lamp (3 mm)



## OVLBx4C7 Series

### Features:

- High brightness with well-defined spatial radiation patterns
- UV-resistant epoxy lens
- Lead-frame material is iron alloy with tin plated leads
- No stand-offs



### Description:

Each OVLBx4C7 series device is a high-intensity LED mounted in a clear plastic T-1 package. The LED provides a well-defined and even emission pattern. Its UV-resistant epoxy lens makes this device an optimal solution for outdoor applications.

### Applications:

- Pedestrian signals
- Signage and architectural lighting
- Backlighting
- Automotive
- Outdoor/indoor displays

Part Number	Material	Emitted Color	Intensity Typ. mcd	Lens Color
OVLBB4C7	InGaN	Blue	1800	Clear
OVLBG4C7		Green	8400	Clear
OVLBR4C7	AlInGaP	Red	3700	Clear
OVLBY4C7		Yellow	3700	Clear

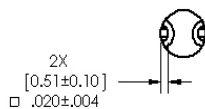
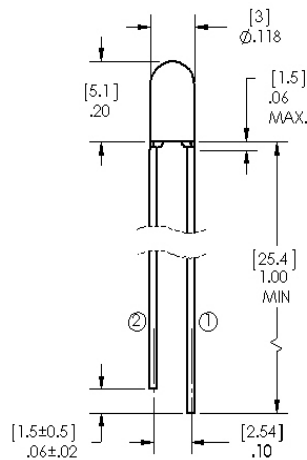

General tolerance +/- .25mm unless

- ① ANODE
- ② CATHODE

Dimensions are in Inches [MM]

**DO NOT LOOK DIRECTLY AT LED WITH UNSHIELDED EYES OR DAMAGE TO RETINA MAY**

### General Note

TT Electronics reserves the right to make changes in product specification without notice or liability. All information is subject to TT Electronics' own data and is considered accurate at time of going to print.

TT Electronics | Optek Technology, Inc.  
1645 Wallace Drive, Ste. 130, Carrollton, TX USA 75006 | Ph: +1 972 323 2200  
www.ttelectronics.com | sensors@ttelectronics.com

### Electrical Specifications

#### Absolute Maximum Ratings ( $T_A = 25^\circ\text{C}$ unless otherwise noted)

Storage Temperature Range		-40 ~ +100 °C
Operating Temperature Range		-40 ~ +100 °C
Reverse Voltage (Device not designed for reverse voltage applications)		5 V Max
Continuous Forward Current (Design of heat dissipation should be considered)	Blue, Green	25 mA
Continuous Forward Current (Design of heat dissipation should be considered)	Red, Yellow	50 mA
Peak Forward Current (10% Duty Cycle, 1 kHz)	Blue, Green	100 mA
Peak Forward Current (10% Duty Cycle, 1 kHz)	Red, Yellow	100 mA
Power Dissipation	Blue, Green	100 mW
Power Dissipation	Red, Yellow	120 mW
Current Linearity vs Ambient Temperature	Blue, Green	-0.29 mA/°C
Current Linearity vs Ambient Temperature	Red, Yellow	-0.72 mA/°C
LED Junction Temperature		125° C
Electrostatic Discharge Classification (JEDEC-JESD22-A114F)		Class 1C
Lead Soldering Temperature (4 mm away from the base of the epoxy bulb)		260° C / 3 seconds

#### Electrical Characteristics ( $T_A = 25^\circ\text{C}$ unless otherwise noted)

SYMBOL	PARAMETER	COLOR	MIN	TYP	MAX	UNITS	CONDITIONS
$I_V$	Luminous Intensity	Blue	1135	1800	----	mcd	$I_F = 20\text{ mA}$
		Green	4360	8400	----		
		Red	2225	3700	----		
		Yellow	2225	3700	----		
$V_F$	Forward Voltage	Blue	2.6	3.2	4.0	V	$I_F = 20\text{ mA}$
		Green					
		Red	1.8	2.0	2.4		
		Yellow					
$I_R$	Reverse Current	Blue	----	----	10	$\mu\text{A}$	$V_R = 5\text{ V}$
		Green	----	----			
		Red	----	----			
		Yellow	----	----			
$\lambda_D$	Dominant Wavelength	Blue	460	470	475	nm	$I_F = 20\text{ mA}$
		Green	519	525	531		
		Red	620	623	630		
		Yellow	585	589	595		
2 $\theta_{\frac{1}{2}}$ H-H	50% Power Angle		----	45	----	deg	$I_F = 20\text{ mA}$

#### General Note

TT Electronics reserves the right to make changes in product specification without notice or liability. All information is subject to TT Electronics' own data and is considered accurate at time of going to print.

TT Electronics | Optek Technology, Inc.  
1645 Wallace Drive, Ste. 130, Carrollton, TX USA 75006 | Ph: +1 972 323 2200  
www.ttelectronics.com | sensors@ttelectronics.com

### Typical Electro-Optical Characteristics Curves (BLUE)

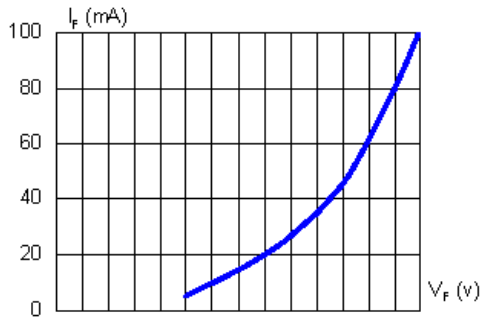

Fig.1 Forward Current vs. Forward Voltage

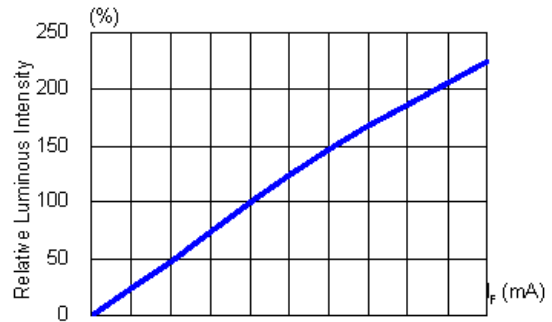

Fig.2 Luminous Intensity vs. Forward Current

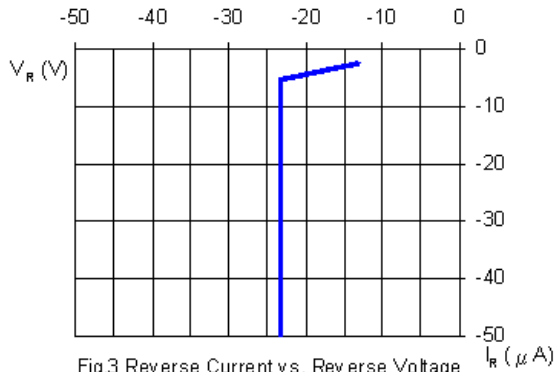

Fig.3 Reverse Current vs. Reverse Voltage

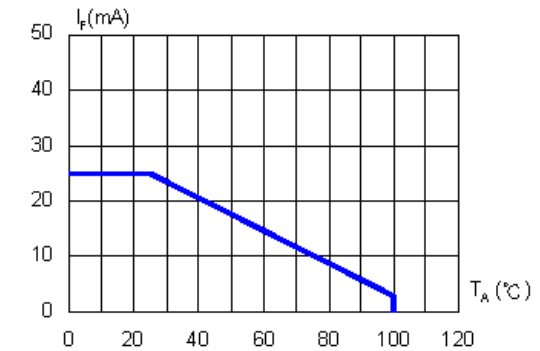

Fig.4 Allowable Forward Current vs. Ambient Temperature

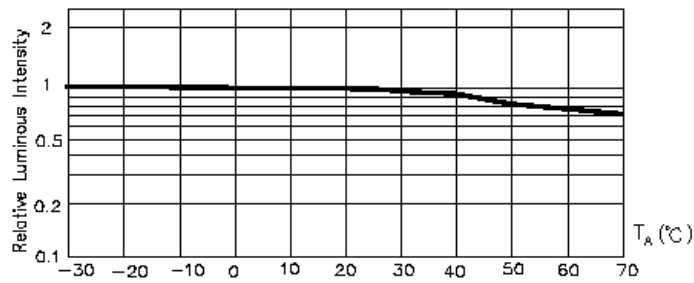

Fig.5 Luminous Intensity at  $I_F=20mA$  vs. Ambient Temperature

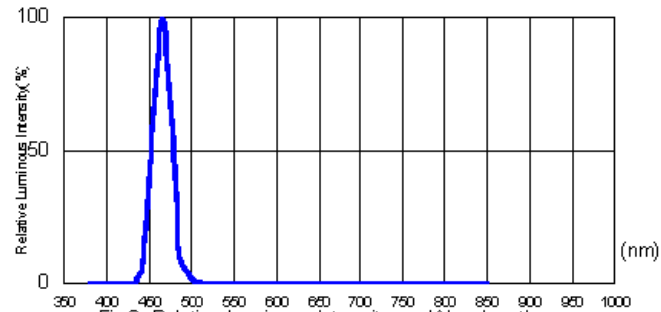

Fig.6. Relative Luminous Intensity vs. Wavelength

**General Note**

TT Electronics reserves the right to make changes in product specification without notice or liability. All information is subject to TT Electronics' own data and is considered accurate at time of going to print.

TT Electronics | Optek Technology, Inc.  
1645 Wallace Drive, Ste. 130, Carrollton, TX USA 75006 | Ph: +1 972 323 2200  
www.ttelectronics.com | sensors@ttelectronics.com

### Typical Electro-Optical Characteristics Curves (GREEN)

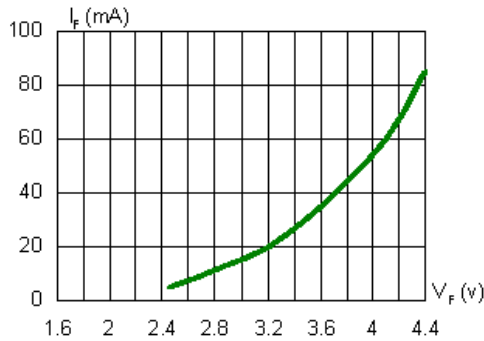

Fig.1 Forward Current vs. Forward Voltage

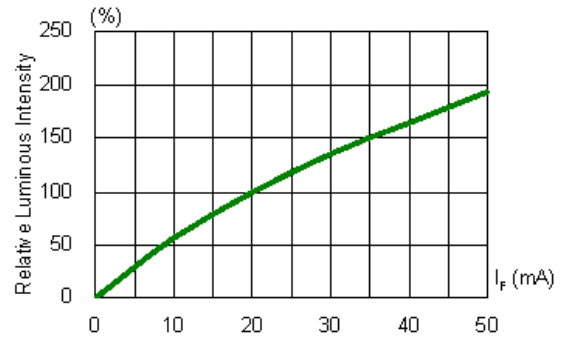

Fig.2 Luminous Intensity vs. Forward Current

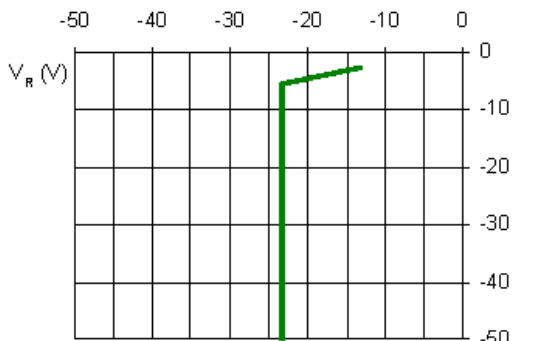

Fig.3 Reverse Current vs. Reverse Voltage

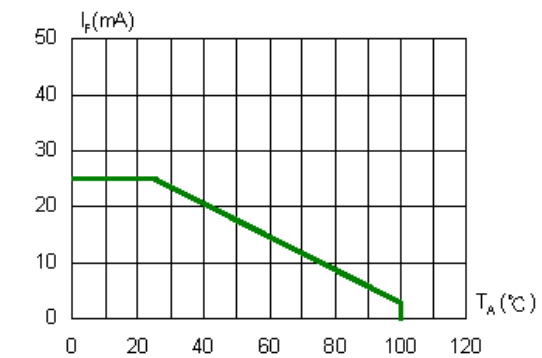

Fig.4 Allowable Forward Current vs. Ambient Temperature

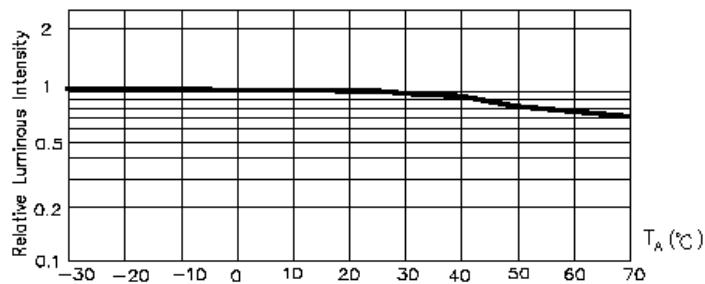

Fig.5 Luminous Intensity at  $I_F = 20mA$  vs. Ambient Temperature

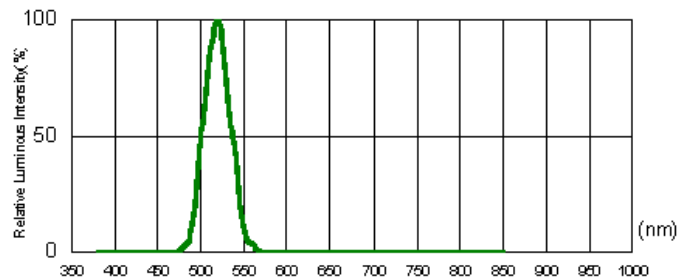

Fig.6. Relative Luminous Intensity vs. Wavelength

**General Note**

TT Electronics reserves the right to make changes in product specification without notice or liability. All information is subject to TT Electronics' own data and is considered accurate at time of going to print.

TT Electronics | Optek Technology, Inc.  
1645 Wallace Drive, Ste. 130, Carrollton, TX USA 75006 | Ph: +1 972 323 2200  
www.ttelectronics.com | sensors@ttelectronics.com

### Typical Electro-Optical Characteristics Curves (RED)



Fig.1 Forward Current vs. Forward Voltage

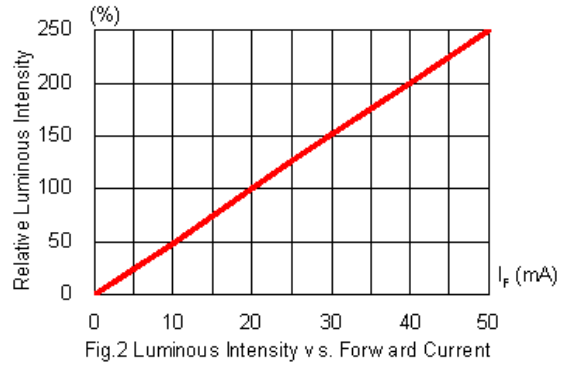

Fig.2 Luminous Intensity vs. Forward Current

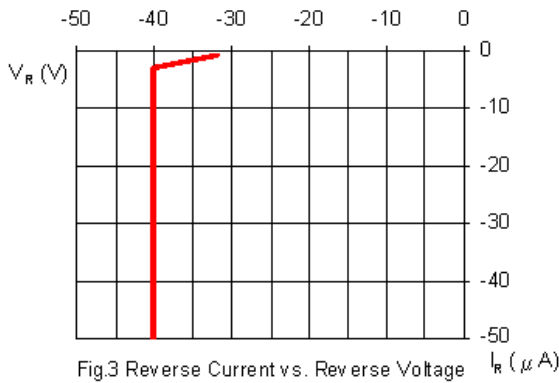

Fig.3 Reverse Current vs. Reverse Voltage

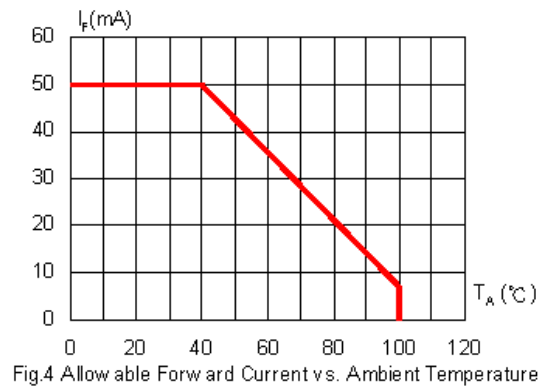

Fig.4 Allowable Forward Current vs. Ambient Temperature

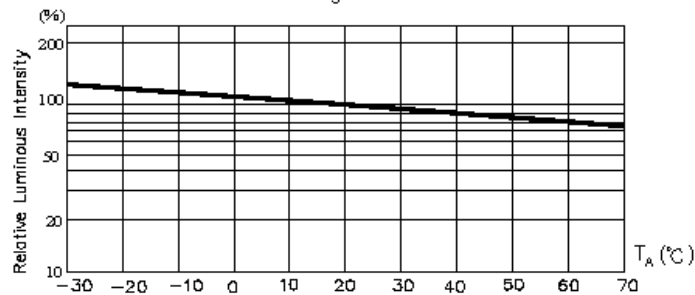

Fig.5 Luminous Intensity at  $I_f = 20mA$  vs. Ambient Temperature

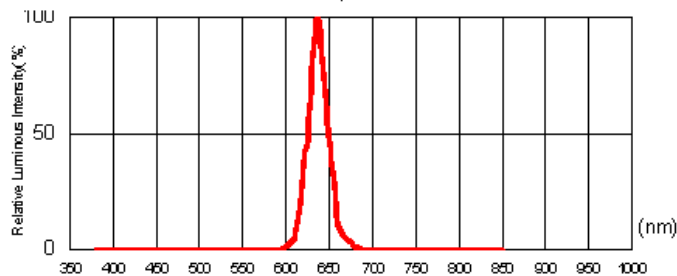

Fig.6. Relative Luminous Intensity vs. Wavelength

**General Note**

TT Electronics reserves the right to make changes in product specification without notice or liability. All information is subject to TT Electronics' own data and is considered accurate at time of going to print.

TT Electronics | Optek Technology, Inc.  
1645 Wallace Drive, Ste. 130, Carrollton, TX USA 75006 | Ph: +1 972 323 2200  
www.ttelectronics.com | sensors@ttelectronics.com

### Typical Electro-Optical Characteristics Curves (YELLOW)

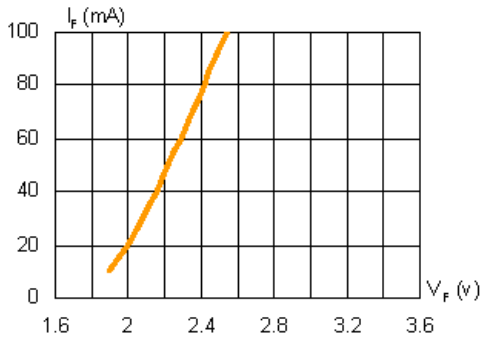

Fig.1 Forward Current vs. Forward Voltage

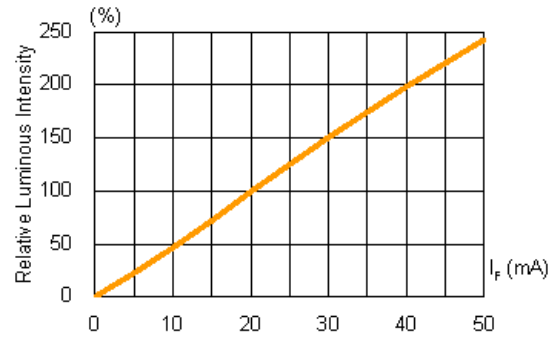

Fig.2 Luminous Intensity vs. Forward Current

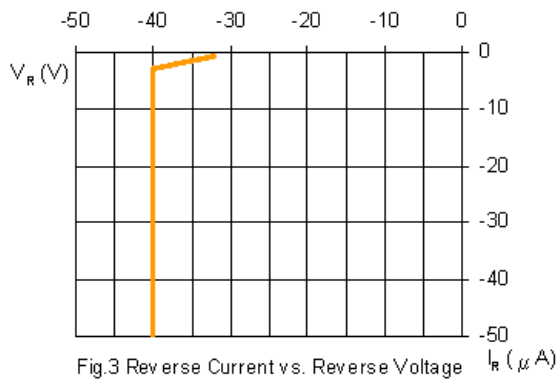

Fig.3 Reverse Current vs. Reverse Voltage

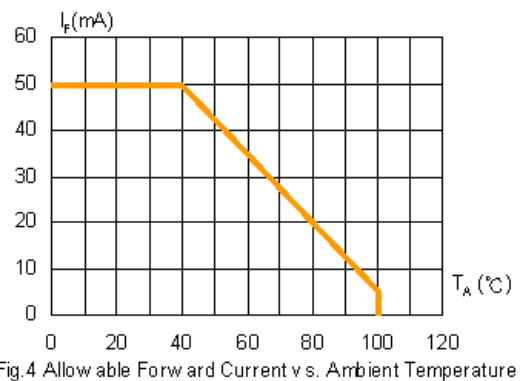

Fig.4 Allowable Forward Current vs. Ambient Temperature

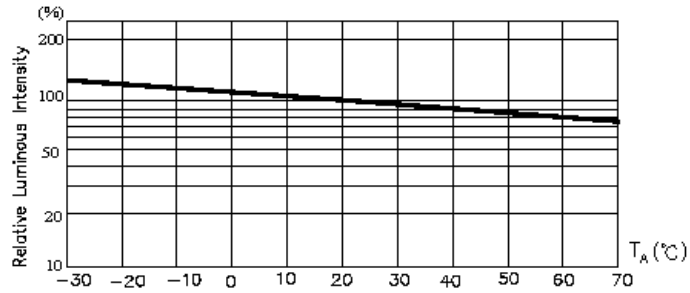

Fig.5 Luminous Intensity at  $I_f=20mA$  vs. Ambient Temperature

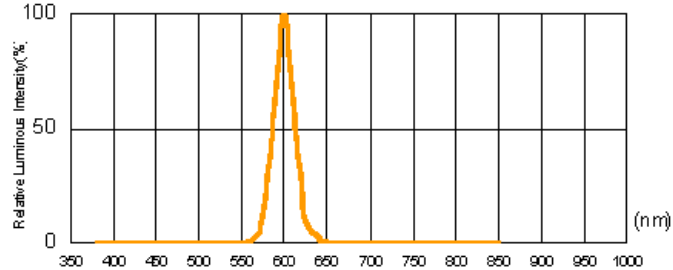

Fig.6. Relative Luminous Intensity vs. Wavelength

**General Note**

TT Electronics reserves the right to make changes in product specification without notice or liability. All information is subject to TT Electronics' own data and is considered accurate at time of going to print.

TT Electronics | Optek Technology, Inc.  
1645 Wallace Drive, Ste. 130, Carrollton, TX USA 75006 | Ph: +1 972 323 2200  
www.ttelectronics.com | sensors@ttelectronics.com

# Round Through-Hole LED Lamp (3 mm)

## OVLBx4C7 Series



Beam Pattern:

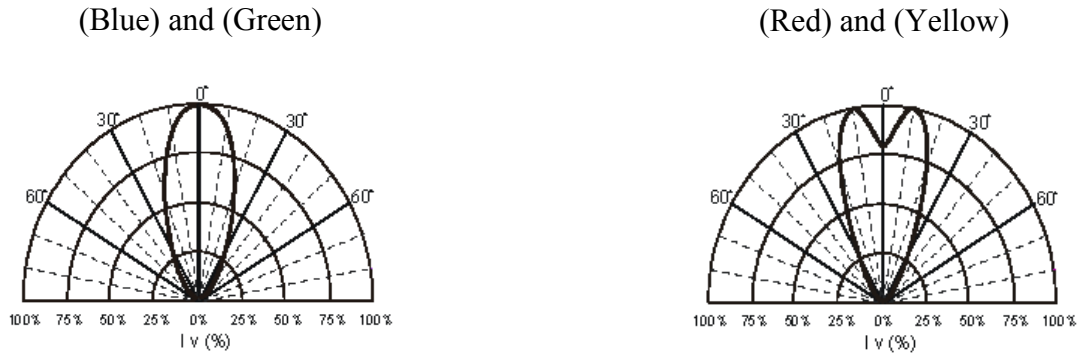

Packaging: 500 pcs per bulk bag with desiccant

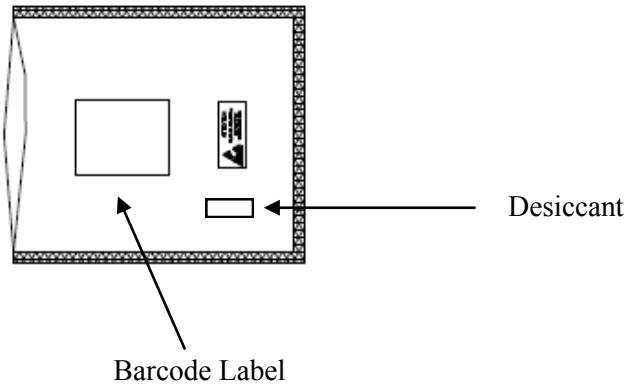

### Reliability Test

Classification	Test Item	Standard Test Method	Test Conditions	Duration	Unit	Acc / Rej Criteria	Result
Life Test	Operation Life Test (OLT)	MIL-STD-750D Method 1026.3	$T_A=25^{\circ}\text{C}$ , $I_F=30\text{mA}$ *	1000 Hrs	100	0 / 1	Pass
Environment Test	High Temperature Storage (HTS)	MIL-STD-750D Method 1032.1	$T_A=100^{\circ}\text{C}$	1000 Hrs	100	0 / 1	Pass
	Low Temperature Storage (LTS)	MIL-STD-750D Method 1032.1	$T_A=-40^{\circ}\text{C}$	1000 Hrs	100	0 / 1	Pass
	Temp. & Humidity with Bias (THB)	MIL-STD-750D Method 103B	$T_A=85^{\circ}\text{C}$ , $\text{Rh}=85\%$ $I_F=20\text{mA}$ **	500 Hrs	100	0 / 1	Pass
	Thermal Shock Test (TST)	MIL-STD-750D Method 1056.1	$0^{\circ}\text{C} \sim 100^{\circ}\text{C}$ 2min 2min	100 cycles	100	0 / 1	Pass
	Temperature Cycling Test (TCT)	MIL-STD-750D Method 1051.5	$-40^{\circ}\text{C} \sim 25^{\circ}\text{C} \sim 100^{\circ}\text{C} \sim 25^{\circ}\text{C}$ 30min 5min 30min 5min	100 cycles	100	0 / 1	Pass
Mechanical Test	Solderability	MIL-STD-750D Method 2026.4	$235\pm 5^{\circ}\text{C}$ , 5 sec	1 time	20	0 / 1	Pass
	Resistance to Soldering Heat	MIL-STD-750D Method 2031.1	$260\pm 5^{\circ}\text{C}$ , 10 sec	1 time	20	0 / 1	Pass
	Lead Integrity	MIL-STD-750D Method 2036.3	Load 2.5N (0.25kgf) $0^{\circ} \sim 90^{\circ} \sim 0^{\circ}$ , bend	3 times	20	0 / 1	Pass

Remark : (\*)  $I_F=30\text{mA}$  for AlInGaP chip ;  $I_F=20\text{mA}$  for InGaN chip

(\*\*)  $I_F=20\text{mA}$  for AlInGaP chip ;  $I_F=10\text{mA}$  for InGaN chip

### 2. Failure Criteria ( $T_A=25^{\circ}\text{C}$ ):

Test Item	Symbol	Test Conditions	Criteria for Judgment	
			Min.	Max.
Luminous Intensity	$I_V$	$I_F=20\text{mA}$	$\text{LSL}\times 0.7$ **	
Voltage (Forward)	$V_F$	$I_F=20\text{mA}$		$\text{USL}\times 1.1$ *

(\*) USL : Upper Standard Level , (\*\*) LSL : Lower Standard Level

#### General Note

TT Electronics reserves the right to make changes in product specification without notice or liability. All information is subject to TT Electronics' own data and is considered accurate at time of going to print.

TT Electronics | Optek Technology, Inc.  
1645 Wallace Drive, Ste. 130, Carrollton, TX USA 75006 | Ph: +1 972 323 2200  
www.ttelectronics.com | sensors@ttelectronics.com



## Данный компонент на территории Российской Федерации

### Вы можете приобрести в компании MosChip.

Для оперативного оформления запроса Вам необходимо перейти по данной ссылке:

<http://moschip.ru/get-element>

Вы можете разместить у нас заказ для любого Вашего проекта, будь то серийное производство или разработка единичного прибора.

В нашем ассортименте представлены ведущие мировые производители активных и пассивных электронных компонентов.

Нашей специализацией является поставка электронной компонентной базы двойного назначения, продукции таких производителей как XILINX, Intel (ex.ALTERA), Vicor, Microchip, Texas Instruments, Analog Devices, Mini-Circuits, Amphenol, Glenair.

Сотрудничество с глобальными дистрибьюторами электронных компонентов, предоставляет возможность заказывать и получать с международных складов практически любой перечень компонентов в оптимальные для Вас сроки.

На всех этапах разработки и производства наши партнеры могут получить квалифицированную поддержку опытных инженеров.

Система менеджмента качества компании отвечает требованиям в соответствии с ГОСТ Р ИСО 9001, ГОСТ РВ 0015-002 и ЭС РД 009

### Офис по работе с юридическими лицами:

105318, г.Москва, ул.Щербаковская д.3, офис 1107, 1118, ДЦ «Щербаковский»

Телефон: +7 495 668-12-70 (многоканальный)

Факс: +7 495 668-12-70 (доб.304)

E-mail: [info@moschip.ru](mailto:info@moschip.ru)

Skype отдела продаж:

moschip.ru

moschip.ru\_4

moschip.ru\_6

moschip.ru\_9