



SPECIFICATION FOR APPROVAL

TO : _____

REF. No. _____

APPROVED DATE 	CHECKED DATE 	PREPARED DATE 
--	---	--

MODEL No. AK1861HB P.S. (AT)

DESCRIPTION: AC FAN (Lead Free) REV. A

ID No. _____

THIS OFFER IS MADE ACCORDING TO YOUR CURRENT INQUIRY.
UNLESS OTHERWISE REVISED, THIS SPECIFICATION WILL BE FINAL FOR
ALL FUTURE PRODUCTION OF ORDERS FROM YOUR RESPECTED COMPANY

KINDLY STUDY IN DETAILS AND RETURN TO US THE DUPLICATE DULY
SIGNED AS YOUR CONFIRMATION OF SAME.



ISO14001:2001
Certificate No.201080



ISO 9001:2000
QS-9000:1998
Certificate No.A8035

ADDA ADDA CORPORATION

DATA - SHEET

Engineering

Printed On:
2007/3/6

BRUSHLESS AXIAL COOLING FANS

Customer :	Ref: (LF)	
Adda Model No : AK1861HB P.S:(AT)		
Samples attached : Piece(s),		
Safety Approval : UL,CUL,TUV,CE		
<u>Specifications</u>		
<u>ITEM</u>	<u>SPECIFICATION / CONDITION</u>	
MEASUREMENTS	: 180x180x65 MM	
BEARING TYPE	: BALL	
RATED	: 110 VAC +/- 10%	
OPERATING VOLTAGE RANGE	: 100 - 120 VAC	
OPERATING FREQUENCY	: 50 / 60 Hz	
RATED CURRENT	: 0.53 / 0.50 A	
INPUT POWER	: 50 / 52 Watt .	
RATED SPEED	: 2650 / 3200 RPM +/- 10 %	
AIR FLOW	: 318.0 / 382.0 CFM (min at zero static pressure.)	
STATIC AIR PRESSURE	: 0.606 / 0.787 INCH-H2O (min at zero air flow.)	
NOISE LEVEL	: 70.0 / 72.0 dB (A) ±2	
NET WEIGHT	: 1800 Gram.	
PACKING	: 10 pcs. Per Export Carton.	
		
ADDA CORPORATION	Model No.: AK1861HB P.S:(AT)	Page 1/5

SPECIFICATION

1 · 0 Scope : This documentation defines the mechanical & electrical characteristics of AC brushless fans.

2 · 0 Material :

2 · 1 Housing High quality aluminum die-casting frame flated with black paint.

2 · 2 Fan blade UL 94V - 0 Glass filled polyester (P.B.T)

2 · 3 Bearing Sys Oil impregnated sleeve or
 Ball Bearing : Japan
 Hypro Bearing
 one Ball one Sleeve
 Lead Free

2 · 4 Lead wire UL 1430 , 22 AWG

2 · 5 Connector Not included in this fan
 Note as : _____

3 · 0 Dimension & construction : All dimension, direction of rotation and air flow, rated characteristics are specified in drawing & data-sheet of enclosed.

4 · 0 Characteristics definition :

4 · 1 Rated current : Rated current shall be measured after 30 minutes continuous rotation at rated voltage.

4 · 2 Rated speed : Rated speed shall be measured after 30 minutes continuous rotation at rated voltage.

4 · 3 Start voltage : The voltages that enable to start the fan by sudden switch on.

4 · 4 Input power : Input power shall be measured after 30 minutes continuous rotation at rated voltage.



SPECIFICATION

- 4 · 5 Locked current : Locked current shall be measured with in one minutes or rotor locked , After 30 minutes continuous rotation at rated voltage in clean air.
- 4 · 6 Air flow & static pressure : The air flow data and static pressures are determined in accordance with AMCA standard or DIN 24163 specification in a double-chamber testing with intake-side measurement.
- 4 · 7 Noise level : The measurement of noise level is carried out with reference to CNS8753 in a anechoic chamber with the microphone positioned 1 M from the air intake. Testing fan shall be hung in clear air.

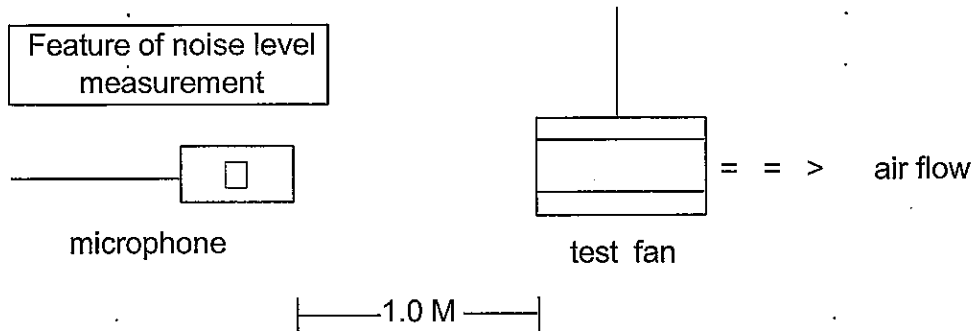

5 · 0 Mechanical inspection

- 5 · 1 Rotation direction : Clockwise from the front face of the fan. A clear " = = > " (arrow mark) shall be found on the body of housing .
- 5 · 2 Safe design : All fans have intergrated protection against locked rotor condition so that there can be no damage on winding and / or any electrical components. Restart is automatic as soon as any constraint to running has been released.



SPECIFICATION

5 · 3 Locked rotor protection : No damage shall be found for continuous 72 hours at condition of rotation locked. Restart is automatic as soon as constraint to running has been released.

5 · 4 Free drop shock : In minute package condition. The fan should withstand each one drop of three faces from 30 cm distance height onto 10 mm thickness of wooden board

6 · 0 Electrical inspection

6 · 1 Insulation resistance : 100 MΩ or more at 500 V megger.

6 · 2 Dielectric strength : 1 minute at 1500 VAC / 50-60Hz

6 · 3 Basic Rated Life (L10)

Bearing type	Temperature	Hours
Sleeve bearing	25°C	31000
	50°C	15000
	70°C	10000
Ball bearing	25°C	50000
	50°C	30000
	70°C	20000

7 · 0 Environmental

7 · 1 Operating Temperature : - 10°C ~ + 80°C

7 · 2 Humidity RH : 20 % ~ 85 % (Max)

7 · 3 Storage Temperature : Will satisfy performance standards after 500 hours storage at - 40 °C ~ 70 °C (normal humidity) with a 24 - hour recovery period at room temperature.



SPECIFICATION

7.4 Humidity : After 96 hrs, 95 % RH, 40 ± 2 °C per MIL - STD - 202F, method 103B, Humidity test, The measured data of insulation resistance & dielectric strength should meet the specification listed in attach.

7.5 Thermal Shock : After thermal shock test per MIL - STD - 202F, method 107G, condition D, The measured data of insulation resistance & dielectric strength should the specification listed in datasheet.

8.0 Remark

8.1 Material and construction are subject to change without advance notice. The changes should be within specification listed in this approved sheet.

8.2 All the fans shall meet the inspection under sampling plan MIL - STD - 105E, The AQL are as follow :

Critical	AQL = 0.25 %
Major	AQL = 1.00 %
Minor	AQL = 2.50 %

9.0 Drawing

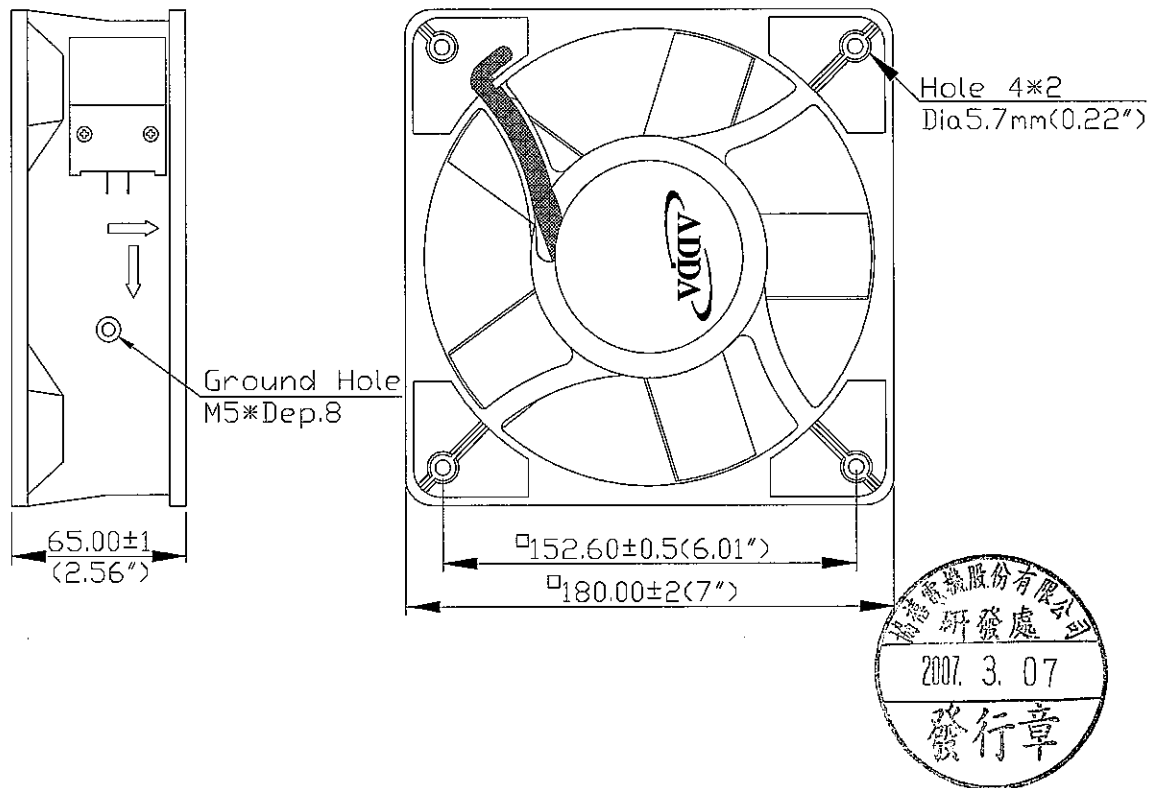

ML FILE NO. E132139

Issued: 2006-05-03

MULTIPLE RECOGNITION
of
FANS, ELECTRIC - COMPONENT
(GPWV2, GPWV8)
for

[349050-002] ADDA CORP

Basically Recognized for:

[420883-001] SHENG KWEI ENTERPRISE CO LTD (TPI)

Basically Recognized products covered by Procedure and/or Reports under File No. E202962, Volume 1

Products Covered	Report Date	Basic Applicant's (Supplier's) Product Designation	Multiple Listee's Product Designations	
AC Fans	1999-09-07	SK825AP-11-1	AK8251HB	
		SK825AP-22-1	AK8252HB	
		SK92AP-11-1	AK9251HB	
		SK92AP-22-1	AK9252HB	
		SK109AP-11-1	AK1281HB	
		SK109AP-22-1	AK1282HB	
		SK172AP-11-1	AK1751HB	
		SK172AP-22-1	AK1752HB	
		2002-01-14	SK825AP-11-2	AK8251MB
			SK825AP-11-3	AK8251LB
			SK838AP-11-1	AK8381HB
			SK838AP-11-2	AK8381MB
			SK838AP-11-3	AK8381LB
			SK92AP-11-2	AK9251MB
	SK92AP-11-3		AK9251LB	
	SK938AP-11-1		AK9381HB	
	SK938AP-11-2		AK9381MB	
	SK938AP-11-3		AK9381LB	
	SK125AP-11-1		AK1251HB	
	SK125AP-11-2		AK1251MB	
	SK125AP-11-3	AK1251LB		
	SK109AP-11-2	AK1281MB		
	SK109AP-11-3	AK1281LB		

MARKING: Same as that described in Follow-Up Service Procedure and/or Report except for Multiple Listee's name, ML Tradename, when applicable, and product designation.

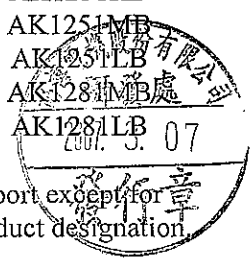

Issued: 2006-05-03

M/L [349050-002] ADDA CORP

AP [420883-001] SHENG KWEI ENTERPRISE CO LTD (TPI)

Products Covered	Report Date	Basic Applicant's (Supplier's) Product Designation	Multiple Listee's Product Designations
	2002-01-15	SK825AP-22-2	AK8252MB
		SK825AP-22-3	AK8252LB
		SK838AP-22-1	AK8382HB
		SK838AP-22-2	AK8382MB
		SK838AP-22-3	AK8382LB
		SK92AP-22-2	AK9252MB
		SK92AP-22-3	AK9252LB
		SK938AP-22-1	AK9382HB
		SK938AP-22-2	AK9382MB
		SK938AP-22-3	AK9382LB
		SK125AP-22-1	AK1252HB
		SK125AP-22-2	AK1252MB
		SK125AP-22-3	AK1252LB
		SK109AP-22-2	AK1282MB
		SK109AP-22-3	AK1282LB
	2002-01-16	SK162AP-11-1	AK1651HB
		SK162AP-11-2	AK1651MB
		SK162AP-11-3	AK1651LB
		SK172AP-11-2	AK1751MB
		SK172AP-11-3	AK1751LB
		SK205AP-11-1	AK2071HB
		SK254AP-11-1	AK2581HB
		SK254AP-11-2	AK2581MB
	2002-01-17	SK162AP-22-1	AK1652HB
		SK162AP-22-2	AK1652MB
		SK162AP-22-3	AK1652LB
		SK172AP-22-2	AK1752MB
		SK172AP-22-3	AK1752LB
		SK205AP-22-1	AK2072HB
		SK254AP-22-1	AK2582HB
		SK254AP-22-2	AK2582MB

MARKING: Same as that described in Follow-Up Service Procedure and/or Report except for Multiple Listee's name, ML Tradename, when applicable, and product designation.



Issued: 2006-05-03

M/L [349050-002] ADDA CORP

AP [420883-001] SHENG KWEI ENTERPRISE CO LTD (TPI)

Products Covered	Report Date	Basic Applicant's (Supplier's) Product Designation	Multiple Listee's Product Designations
	2004-05-20	SK176AP-11-1	AK1781HB
		SK176AP-22-1	AK1782HB
		SK180AP-11-1	AK1861HB
		SK180AP-22-1	AK1862HB

MARKING: Same as that described in Follow-Up Service Procedure and/or Report except for Multiple Listee's name, ML Tradename, when applicable, and product designation.

UL INSPECTION CENTER TAICHUNG - 817



Industrial Services, Mobility and Transport,
Product Safety and Quality, Education and
Consulting, IT Services and Innovation



TÜV Rheinland Group

Sheng Kwei Enterprise Co., Ltd.
Mr. Shun-Tung Tsao, President

No. 273, Hsing Nan Street
Tainan City 702
Taiwan

Date : 07.04.2006
Our ref. : IRC ZTW1
Your ref.: 12039117/EH

Ref : R TÜV-Mark Approval

Type of Equipment : (AC Fan)
Model Designation : See Certificate
Certificate No. : R 50081257 0001
Report No. : 10002060 004

Dear Mr. Shun-Tung Tsao,

Enclosed please find above certification documents.
Please forward these originals to the certificate holder.

If you contact our office, please quote our reference above.

We thank you for your cooperation.

The certificate holder is: Adda Corporation

With kind regards,

Certification Body

Dipl.-Ing. W. Hsu

Enclosure



TÜV RHEINLAND TAIWAN LTD.

7F, No. 2, Min Chuan E. Rd., Sec.3,
Taipei 104, Taiwan, R.O.C.
Tel. (02) 2516-6040
Fax (02) 2504-5040
<http://www.twn.tuv.com>

TAICHUNG BRANCH:
10F, No. 219, Min Chuan Rd.,
Taichung 403, Taiwan, R.O.C.
Tel. (04) 2301-9898
Fax (04) 2301-9696

KAOHSIUNG BRANCH:
33F-3, No. 80, Min Tzu 1st Rd.,
Kaohsiung 807, Taiwan, R.O.C.
Tel. (07) 380-1722
Fax (07) 380-1728

NANKANG BRANCH:
No. 99-23, Nan Kang Rd., Sec. 2,
Taipei 115, Taiwan, R.O.C.
Tel. (02) 2783-6650
Fax (02) 2783-7117

Adda Corporation
Mr. You-Wen Huang
R & D Department
6, East Section, Industry 6 Road
Pingtung City 900
Taiwan

Date : 07.04.2006
Our ref. : IRC ZTW1
Your ref.: 12039117/EH

Ref : R TÜV-Mark Approval

Type of Equipment : (AC Fan)
Model Designation : See Certificate
Certificate No. : R 50081257 0001
Report No. : 10002060 004

Dear Mr. You-Wen Huang,

The above specified technical equipment has been tested and found to be in accordance with the relevant requirements.

Enclosed you will find the certificate of approval.

If cancellation of the certificate is submitted by November 15 in a given year, no fee will be charged for the following year.

We appreciate your kind support and would like to offer our assistance and continuous services in the future.

Please contact our office for approval of your new products.

With kind regards,

Certification Body

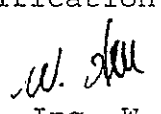
Dipl.-Ing. W. Hsu

CC: Sheng Kwei Enterprise Co., Ltd.

Enclosure



TÜV RHEINLAND TAIWAN LTD.

7F, No. 2, Min Chuan E. Rd., Sec.3,
Taipei 104, Taiwan, R.O.C.
Tel. (02) 2516-6040
Fax (02) 2504-5040
<http://www.twn.tuv.com>

TAICHUNG BRANCH:
10F, No. 219, Min Chuan Rd.,
Taichung 403, Taiwan, R.O.C.
Tel. (04) 2301-9898
Fax (04) 2301-9696

KAOHSIUNG BRANCH:
33F-3, No. 80, Min Tzu 1st Rd.,
Kaohsiung 807, Taiwan, R.O.C.
Tel. (07) 380-1722
Fax (07) 380-1728

NANKANG BRANCH:
No. 99-23, Nan Kang Rd., Sec. 2,
Taipei 115, Taiwan, R.O.C.
Tel. (02) 2783-6650
Fax (02) 2783-7117

Zertifikat

Certificate



Zertifikat Nr. *Certificate No.*
R 50081257

Blatt *Page*
0001

Ihr Zeichen *Client Reference*
12039117/EH

Unser Zeichen *Our Reference*
ZTW1-IRC- 10002060 004

Ausstellungsdatum
07.04.2006

Date of Issue
(day/mo/yr)

Genehmigungsinhaber *License Holder*

Adda Corporation
6, East Section, Industry 6 Road
Pingtung City 900
Taiwan

Fertigungsstätte *Manufacturing Plant*

ZTW1-BIO-10002060 001

Prüfzeichen *Test Mark*

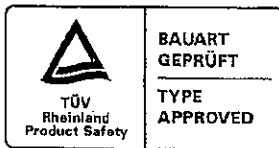

Geprüft nach *Tested acc. to*

EN 60335-1:2002+A1+A11
EN 60335-2-80:2003+A1

Zertifiziertes Produkt (Geräteidentifikation)
Certified Product (Product Identification)

Lizenzentgelte - Einheit
License Fee - Unit

Ventilator (AC Fan)

Bezeichnung (Type Designation)	: AKxxxxyzB	5
xxx steht für (stands for)	: 125, 128, 165, 175, 178, 186, 207 258, 825, 838, 925 oder (or) 938	1
y steht für (stands for)	: 1 oder (or) 2	1
z steht für (stands for)	: H, M oder (or) L	1
Nennspannung (Rated Voltage)	: AC 100-120V, 50/60Hz (y=1) AC 200-240V, 50/60Hz (y=2)	
Nennstrom (Rated Current)	: siehe Anlage (see Appendix)	

8



Dem Zertifikat liegt unsere Prüf- und Zertifizierungsordnung zugrunde.
Das Produkt entspricht den o.g. Anforderungen, die Herstellung wird überwacht.
This certificate is based on our Testing and Certification Regulation. The product fulfills above-mentioned-requirements, the production is subject to surveillance.

TÜV Rheinland Product Safety GmbH, Am Grauen Stein, D-51105 Köln

Tel.:(+49/221)8 06 - 13 71 Fax:(+49/221)8 06 - 39 35 e-mail: Althoff@de.tuv.com

Zertifizierungsstelle



Dipl.-Ing. W. Hsu



Appendix to TÜV Bauart approved Certificate No.: R 50081257

Kind of equipment : AC Fan
 Report number : 10016385 001
 Model Name : AKxxxzyB (xxx= 125, 128, 165, 175, 178, 186, 207, 258,
 825, 838, 925 or 938; y= 1 or 2; z= H, M or L)

Model No.	Voltage (V)	Current (A)
AK8251HB	100-120	0.17/0.15
AK8251MB	100-120	0.09/0.08
AK8251LB	100-120	0.07/0.06
AK8252HB	200-240	0.08/0.07
AK8252MB	200-240	0.06/0.05
AK8252LB	200-240	0.05/0.04
AK8381HB	100-120	0.12/0.10
AK8381MB	100-120	0.07/0.06
AK8381LB	100-120	0.05/0.04
AK8382HB	200-240	0.06/0.05
AK8382MB	200-240	0.05/0.04
AK8382LB	200-240	0.04/0.03
AK9251HB	100-120	0.18/0.16
AK9251MB	100-120	0.09/0.08
AK9251LB	100-120	0.07/0.06
AK9252HB	200-240	0.08/0.07
AK9252MB	200-240	0.06/0.05
AK9252LB	200-240	0.05/0.04
AK9381HB	100-120	0.12/0.11
AK9381MB	100-120	0.07/0.06
AK9381LB	100-120	0.05/0.04
AK9382HB	200-240	0.06/0.05
AK9382MB	200-240	0.05/0.04
AK9382LB	200-240	0.04/0.03
AK1251HB	100-120	0.25/0.20
AK1251MB	100-120	0.09/0.08
AK1251LB	100-120	0.06/0.05

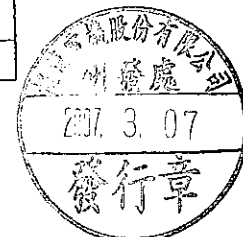

Appendix to TÜV Bauart approved Certificate No.: R 50081257

Kind of equipment : AC Fan
 Report number : 10016385 001
 Model Name : AKxxxxyzB (xxx= 125, 128, 165, 175, 178, 186, 207, 258,
 825, 838, 925 or 938; y= 1 or 2; z= H, M or L)

Model No.	Voltage (V)	Current (A)
AK1252HB	200-240	0.09/0.07
AK1252MB	200-240	0.06/0.05
AK1252LB	200-240	0.05/0.04
AK1281HB	100-120	0.25/0.21
AK1281MB	100-120	0.14/0.13
AK1281LB	100-120	0.10/0.10
AK1282HB	200-240	0.12/0.10
AK1282MB	200-240	0.07/0.06
AK1282LB	200-240	0.06/0.05
AK1651HB	100-120	0.56/0.50
AK1651MB	100-120	0.28/0.27
AK1651LB	100-120	0.21/0.19
AK1652HB	200-240	0.30/0.25
AK1652MB	200-240	0.17/0.16
AK1652LB	200-240	0.13/0.12
AK1751HB	100-120	0.24/0.25
AK1751MB	100-120	0.17/0.21
AK1751LB	100-120	0.16/0.20
AK1752HB	200-240	0.12/0.16
AK1752MB	200-240	0.10/0.12
AK1752LB	200-240	0.09/0.16
AK1781HB	100-120	0.57/0.48
AK1782HB	200-240	0.21/0.23
AK1861HB	100-120	0.53/0.50
AK1862HB	200-240	0.23/0.24
AK2071HB	100-120	0.60/1.0
AK2072HB	200-240	0.30/0.49



Appendix to TÜV Bauart approved Certificate No.: R 50081257

Kind of equipment : AC Fan
 Report number : 10016385 001
 Model Name : AKxxxxyzB (xxx= 125, 128, 165, 175, 178, 186, 207, 258, 825, 838, 925 or 938; y= 1 or 2; z= H, M or L)

Model No.	Voltage (V)	Current (A)
AK2581HB	100-120	0.55/0.62
AK2581MB	100-120	0.22/0.24
AK2582HB	200-240	0.26/0.30
AK2582MB	200-240	0.16/0.14

Date: April 07, 2006

Certification Body

[Signature]
 Dipl.-Ing. Windah/Hsu



Данный компонент на территории Российской Федерации

Вы можете приобрести в компании MosChip.

Для оперативного оформления запроса Вам необходимо перейти по данной ссылке:

<http://moschip.ru/get-element>

Вы можете разместить у нас заказ для любого Вашего проекта, будь то серийное производство или разработка единичного прибора.

В нашем ассортименте представлены ведущие мировые производители активных и пассивных электронных компонентов.

Нашей специализацией является поставка электронной компонентной базы двойного назначения, продукции таких производителей как XILINX, Intel (ex.ALTERA), Vicor, Microchip, Texas Instruments, Analog Devices, Mini-Circuits, Amphenol, Glenair.

Сотрудничество с глобальными дистрибьюторами электронных компонентов, предоставляет возможность заказывать и получать с международных складов практически любой перечень компонентов в оптимальные для Вас сроки.

На всех этапах разработки и производства наши партнеры могут получить квалифицированную поддержку опытных инженеров.

Система менеджмента качества компании отвечает требованиям в соответствии с ГОСТ Р ИСО 9001, ГОСТ РВ 0015-002 и ЭС РД 009

Офис по работе с юридическими лицами:

105318, г.Москва, ул.Щербаковская д.3, офис 1107, 1118, ДЦ «Щербаковский»

Телефон: +7 495 668-12-70 (многоканальный)

Факс: +7 495 668-12-70 (доб.304)

E-mail: info@moschip.ru

Skype отдела продаж:

moschip.ru

moschip.ru_4

moschip.ru_6

moschip.ru_9