



## GaAs MMIC 20W FAILSAFE SWITCH 0.2 - 2.2 GHz

### Typical Applications

The HMC546MS8G(E) is ideal for:

- LNA Protection, WiMAX, WiBro
- Cellular/PCS/3G Infrastructure
- Private Mobile Radio and Public Safety Handsets
- Automotive Telematics

### Features

- High Input P0.1dB: +40 dBm Tx
- Low Insertion Loss: 0.4 dB
- High IIP3: +65 dBm
- Positive Control: 0/+3V to 0/+8V
- Failsafe Operation: Tx "on" When Unpowered

### Functional Diagram

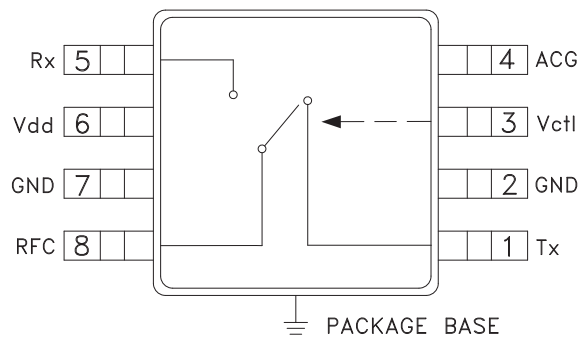

### General Description

The HMC546MS8G(E) is a low-cost SPDT switch in 8-lead MSOP8G surface mount package for use in transmit-receive applications which require very low distortion at high signal power levels, up to 10 watts. The device can control signals from 200 - 2200 MHz\* and is especially suited for cellular booster, PMR and automotive telematic applications. The design provides exceptional P0.1dB of +40 dBm and +65 dBm IIP3 on the Transmit (Tx) port. The failsafe topology allows the switch to provide a low loss path from RFC to Tx, when no DC power is available.

### Electrical Specifications, $T_A = +25^\circ C$ , $V_{dd} = 3V$ , $V_{ctl} = 0/+3 V_{dc}$ , 50 Ohm System\*

Parameter	Min.	Typ.	Max.	Min.	Typ.	Max.	Min.	Typ.	Max.	Min.	Typ.	Max.	Units
Frequency Range	216 - 222			869 - 960			2010 - 2025			2110 - 2170			MHz
Insertion Loss	Tx - RFC	0.4	0.7		0.4	0.7		0.3	0.6		0.4	0.7	dB
	RFC - Rx	0.4	0.7		0.5	0.8		0.5	0.8		1.1	1.5	dB
Isolation	Tx - RFC	25	30		20	24		17	20		8	12	dB
	RFC - Rx	33	40		23	30		25	30		25	30	dB
Return Loss	Tx - RFC		20			25			23			16	dB
	RFC - Rx		20			25			20			13	dB
Input Power for 0.1 dB Compression	Tx - RFC	37	39		37	39		38	>40		38	>40	dBm
	RFC - Rx	19	21		19	21		17.5	19.5		17.5	19.5	dBm
Input Power for 1 dB Compression	Tx - RFC	43			43			43			43		dBm
	RFC - Rx	22			22			22			22		dBm
Input Third Order Intercept (Two-tone input power = +19 dBm each tone)	Tx - RFC		60			66			67			67	dBm
	$V_{ctl} = 0/+3V$ RFC - Rx		31			32			31			31	dBm
	Tx - RFC		60			66			67			67	dBm
	$V_{ctl} = 0/+5V$ RFC - Rx		57			48			37			43	dBm
Switching Characteristics	tRISE, tFALL (10/90% RF)		21			21			21			21	ns
	tON, (50% CTL to 90% RF)		102			102			102			102	ns
	tOFF (50% CTL to 10% RF)		36			36			36			36	ns

\* Specifications and data reflect HMC546MS8G(E) measured using the respective application circuits for each designated frequency band found herein



## GaAs MMIC 20W FAILSAFE SWITCH 0.2 - 2.2 GHz

**Insertion Loss vs. Temperature, Tx with 220 MHz Tuning**

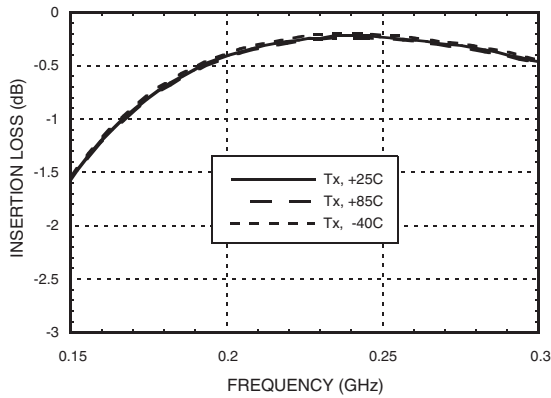

**Insertion Loss vs. Temperature, Rx with 220 MHz Tuning**

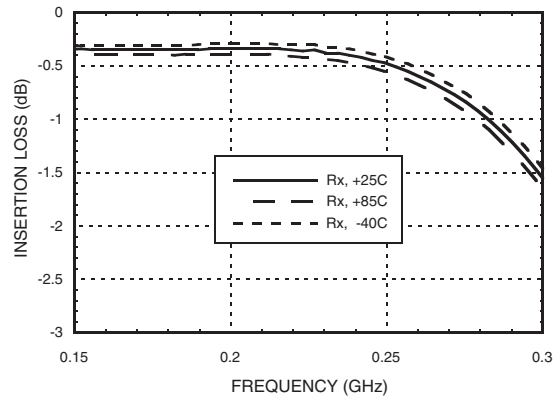

**Isolation with 220 MHz Tuning**

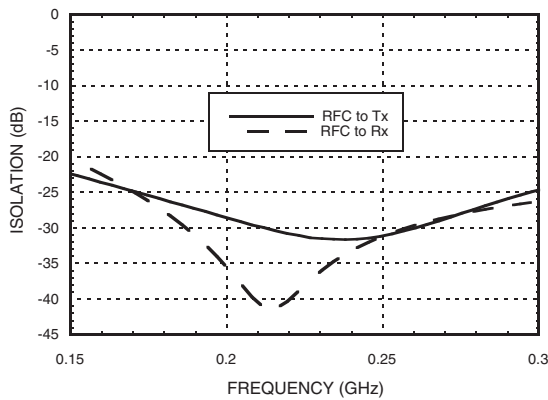

**Return Loss with 220 MHz Tuning**

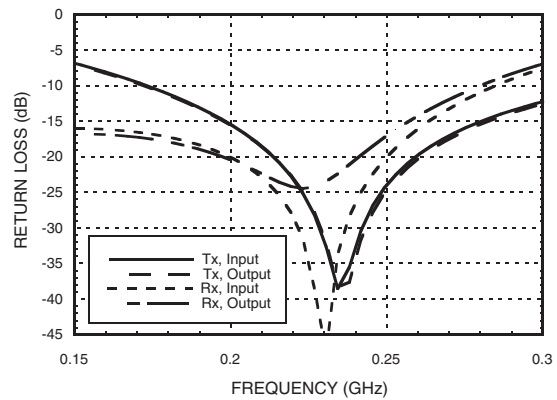

**Input IP3 vs. Voltage with 220 MHz Tuning**

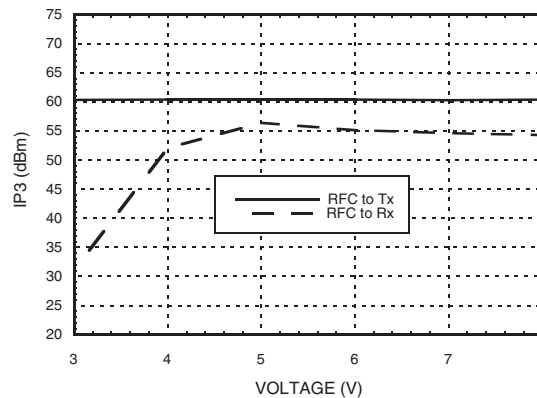



**GaAs MMIC 20W FAILSAFE SWITCH**  
**0.2 - 2.2 GHz**

**Insertion Loss vs. Temperature, Tx with 457 MHz Tuning**

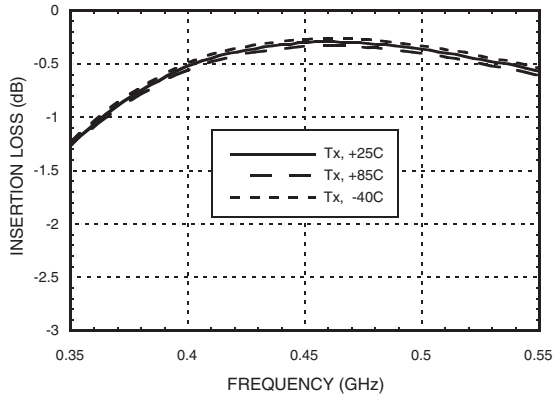

**Insertion Loss vs. Temperature, Rx with 457 MHz Tuning**

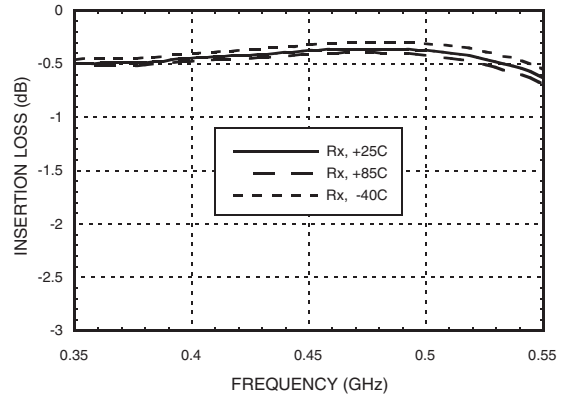

**Isolation with 457 MHz Tuning**

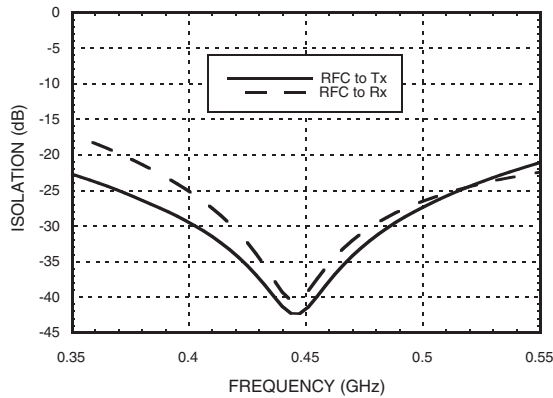

**Return Loss with 457 MHz Tuning**

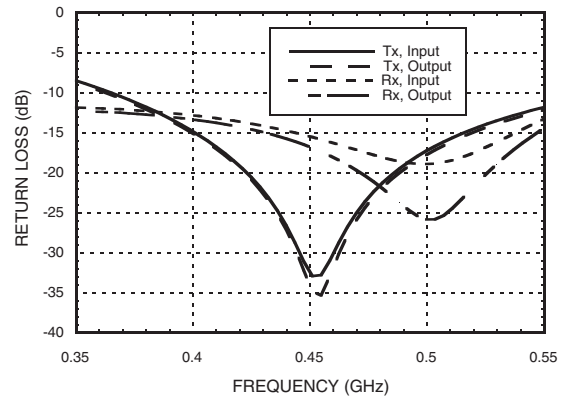

**Input IP3 vs. Voltage with 457 MHz Tuning**

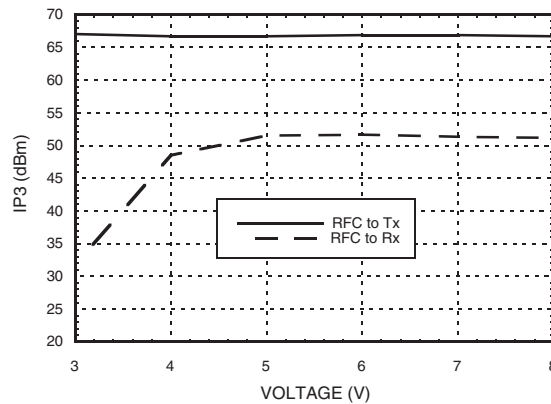



## GaAs MMIC 20W FAILSAFE SWITCH 0.2 - 2.2 GHz

**Insertion Loss vs. Temperature, Tx with 785 MHz Tuning**

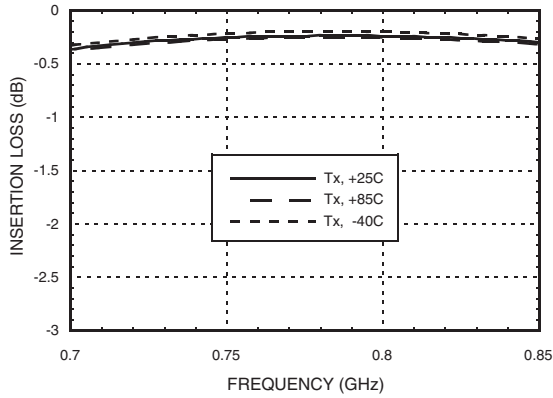

**Insertion Loss vs. Temperature, Rx with 785 MHz Tuning**

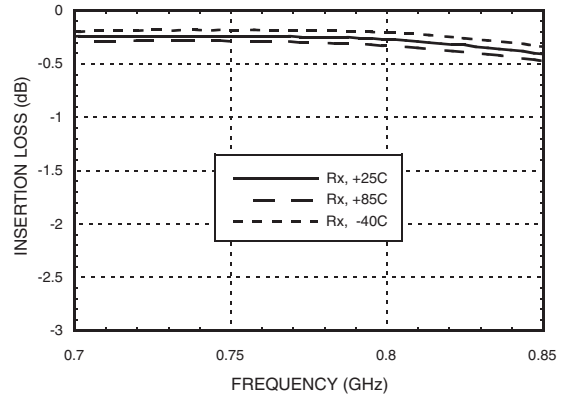

**Isolation with 785 MHz Tuning**

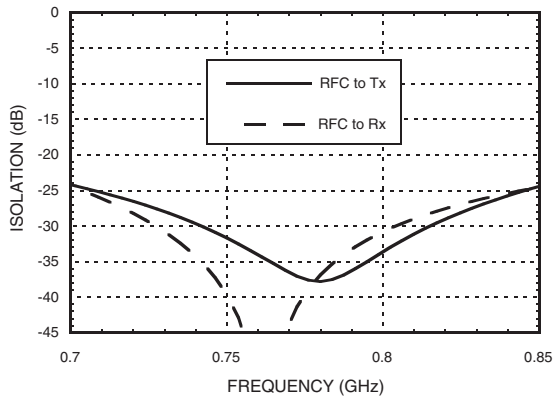

**Return Loss with 785 MHz Tuning**

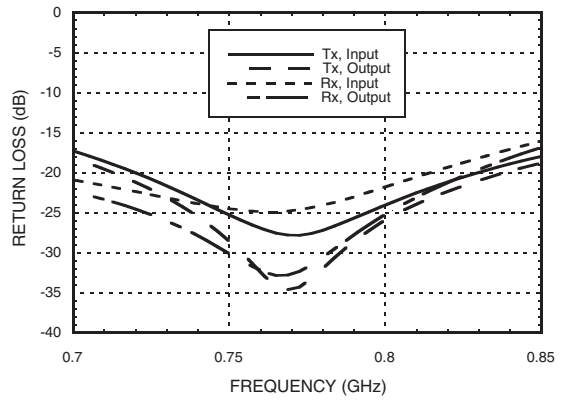

**Input IP3 vs. Voltage with 785 MHz Tuning**

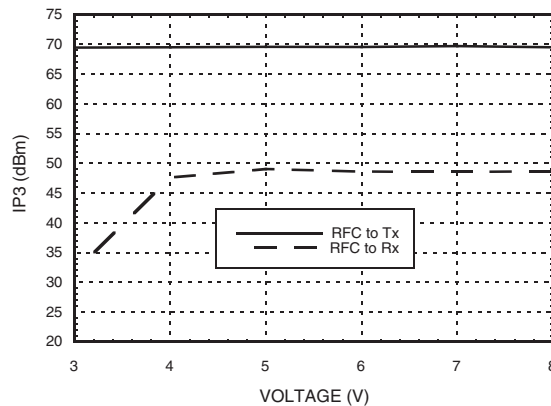



**GaAs MMIC 20W FAILSAFE SWITCH  
0.2 - 2.2 GHz**

**Insertion Loss vs. Temperature, Tx with 915 MHz Tuning**

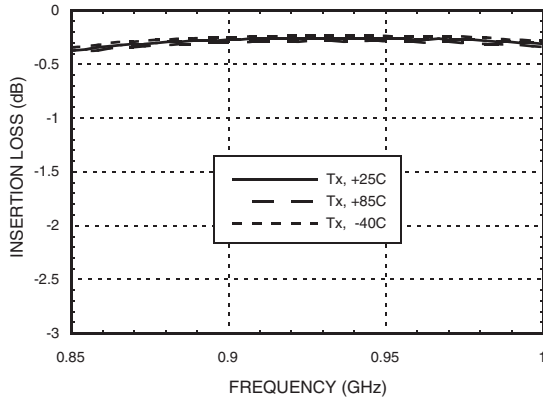

**Insertion Loss vs. Temperature, Rx with 915 MHz Tuning**

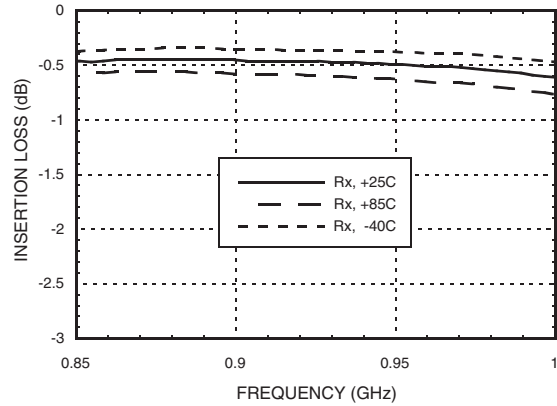

**Isolation with 915 MHz Tuning**

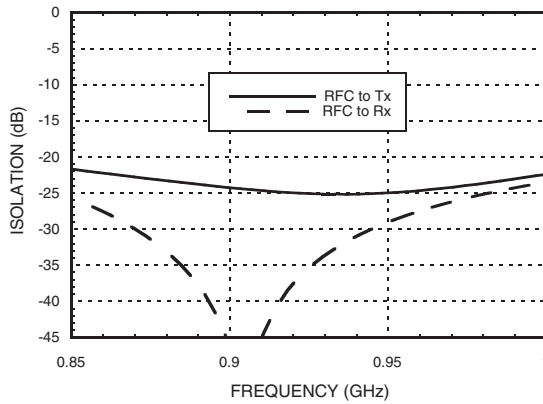

**Return Loss with 915 MHz Tuning**

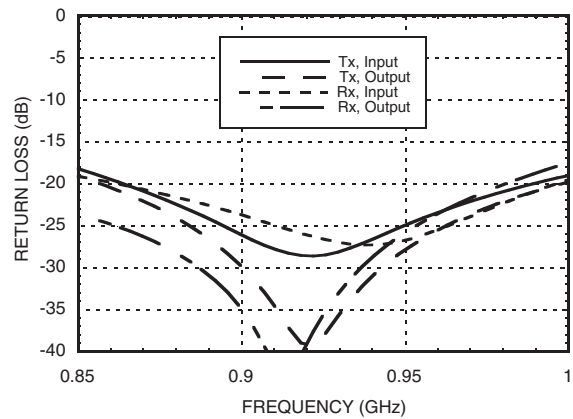

**Input IP3 vs. Voltage with 915 MHz Tuning**

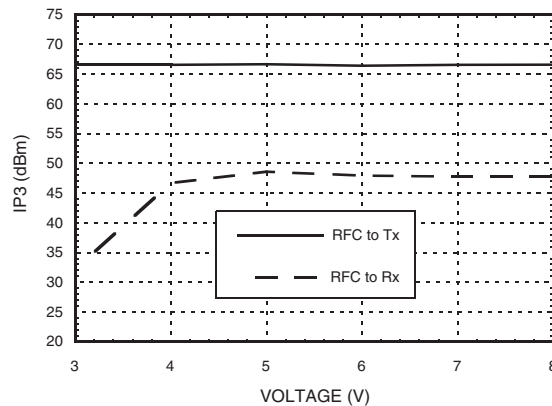



**GaAs MMIC 20W FAILSAFE SWITCH  
0.2 - 2.2 GHz**

**Insertion Loss vs. Temperature, Tx with 1843 MHz Tuning**

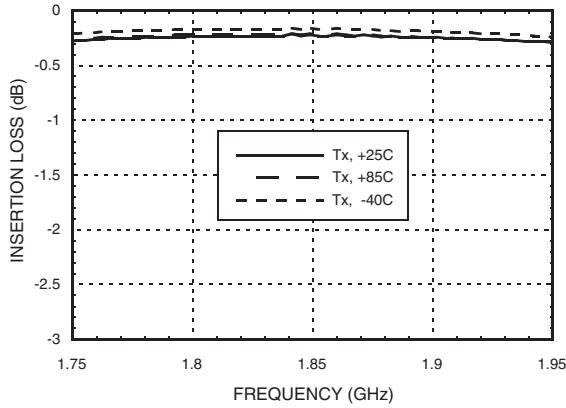

**Insertion Loss vs. Temperature, Rx with 1843 MHz Tuning**

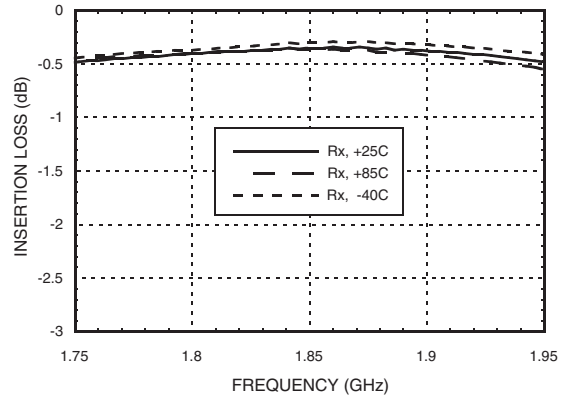

**Isolation with 1843 MHz Tuning**

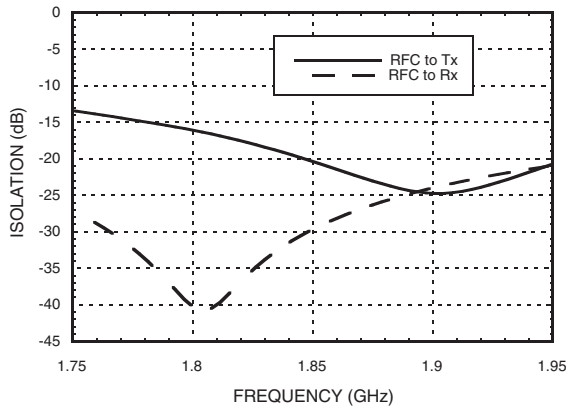

**Return Loss with 1843 MHz Tuning**

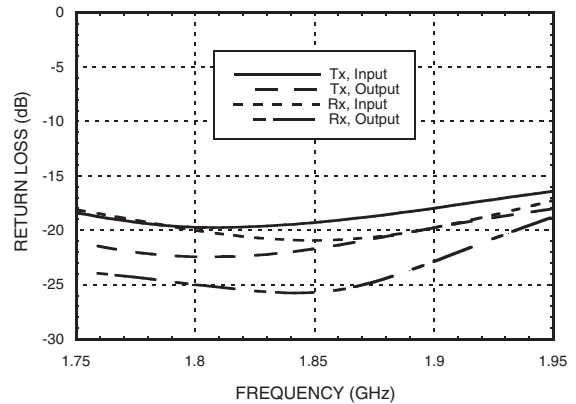

**Input IP3 vs. Voltage with 1843 MHz Tuning**

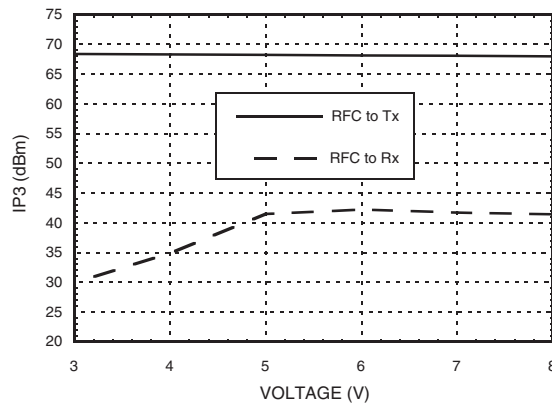



**GaAs MMIC 20W FAILSAFE SWITCH  
0.2 - 2.2 GHz**

**Insertion Loss vs. Temperature, Tx with 1960 MHz Tuning**

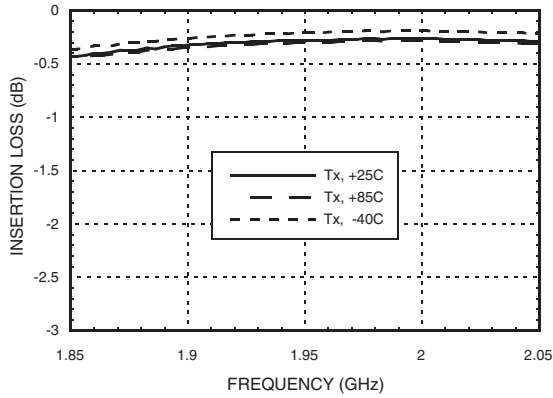

**Insertion Loss vs. Temperature, Rx with 1960 MHz Tuning**

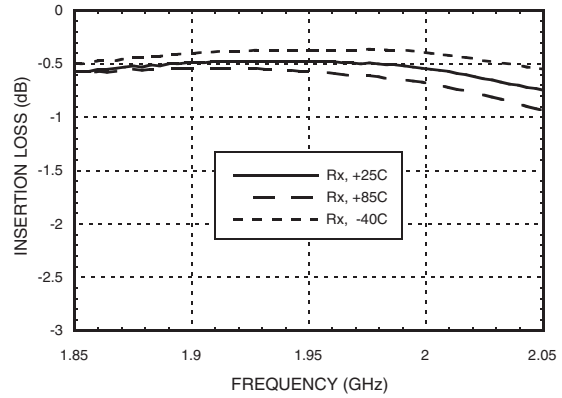

**Isolation with 1960 MHz Tuning**

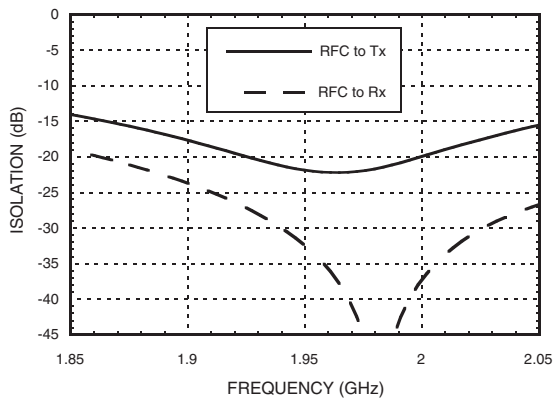

**Return Loss with 1960 MHz Tuning**

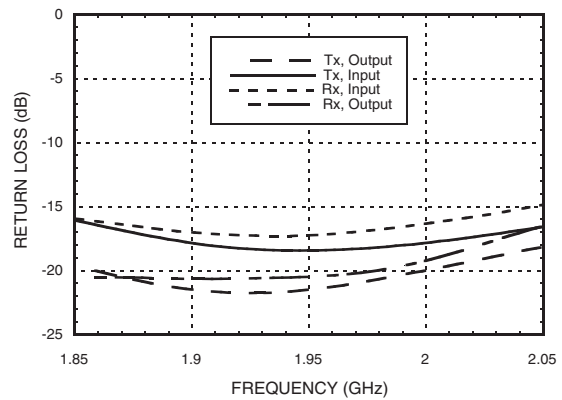

**Input IP3 vs. Voltage with 1960 MHz Tuning**

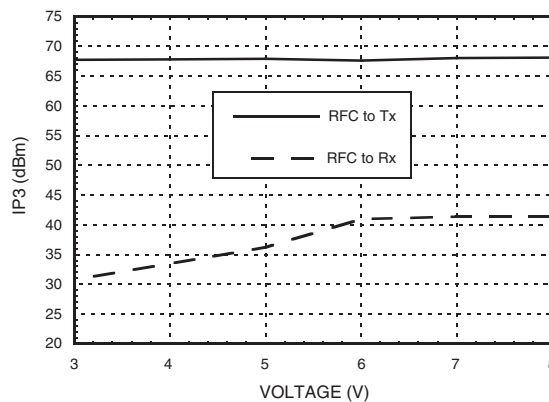



## GaAs MMIC 20W FAILSAFE SWITCH 0.2 - 2.2 GHz

**Insertion Loss vs. Temperature, Tx with 2015 MHz Tuning**

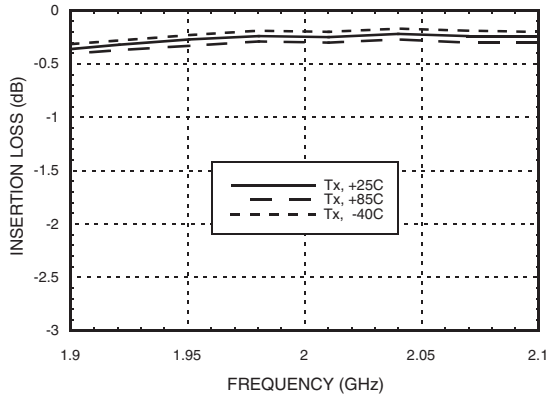

**Insertion Loss vs. Temperature, Rx with 2015 MHz Tuning**

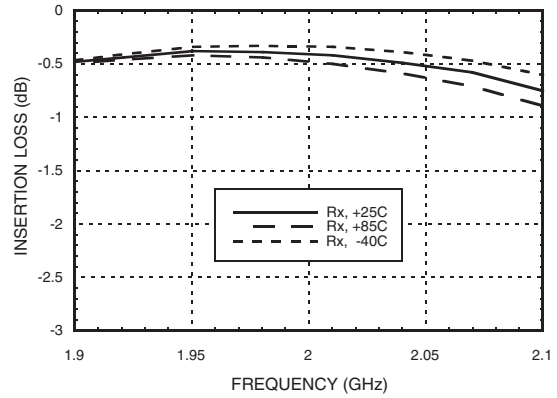

**Isolation with 2015 MHz Tuning**

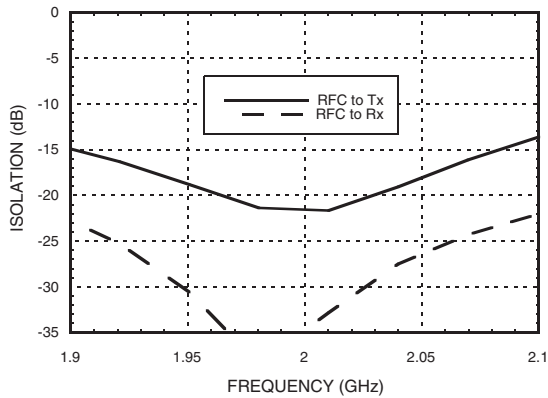

**Return Loss with 2015 MHz Tuning**

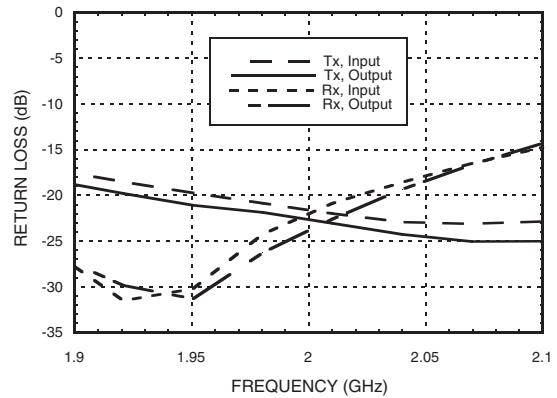

**Input IP3 vs. Voltage with 2015 MHz Tuning**

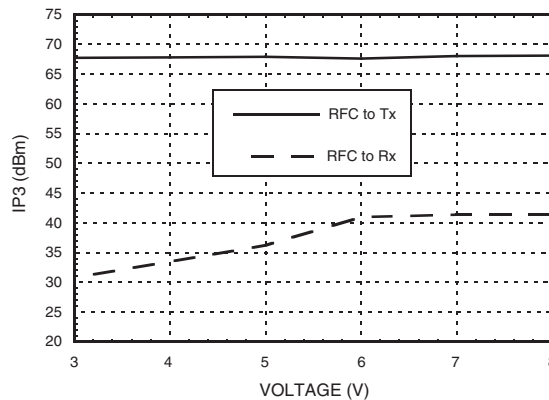





**GaAs MMIC 20W FAILSAFE SWITCH  
0.2 - 2.2 GHz**

**Insertion Loss vs. Temperature, Tx with 2140 MHz Tuning**

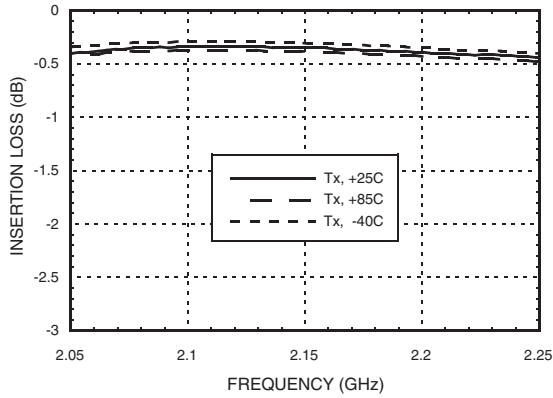

**Insertion Loss vs. Temperature, Rx with 2140 MHz Tuning**

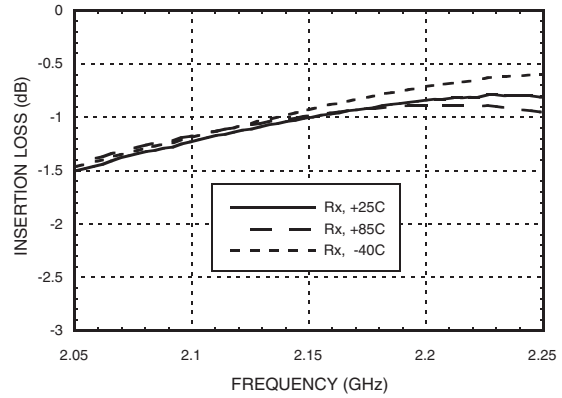

**Isolation with 2140 MHz Tuning**

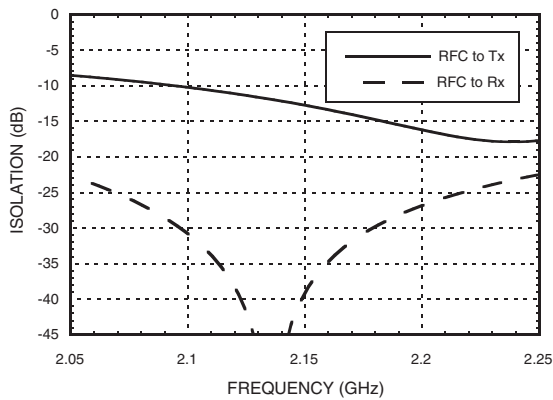

**Return Loss with 2140 MHz Tuning**

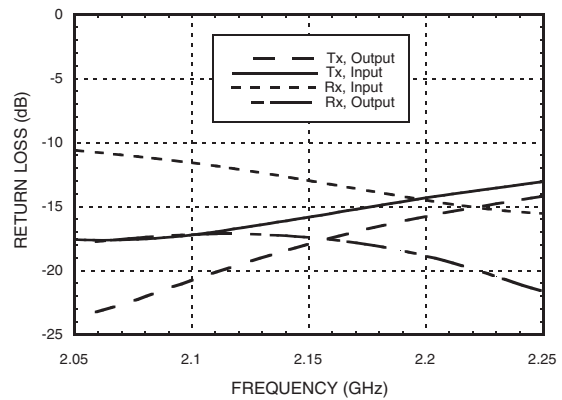

**Input IP3 vs. Voltage with 2140 MHz Tuning**

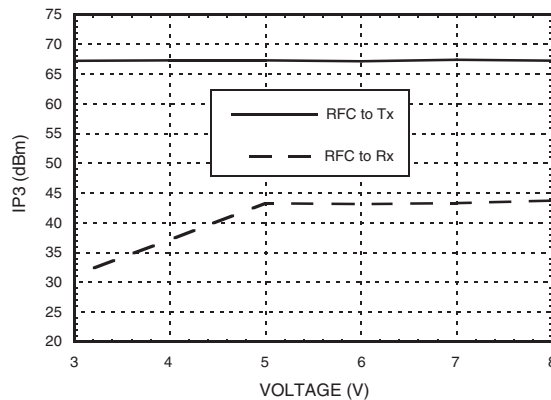



## GaAs MMIC 20W FAILSAFE SWITCH 0.2 - 2.2 GHz

### Absolute Maximum Ratings

		3V	5V
Max. CW Input Power [1][2]	Tx Port	40 dBm	40 dBm
	Rx Port	24 dBm	29 dBm
Max Channel Temp.		150 °C	150 °C
Thermal Resistance	Tx Port	54 °C/W	54 °C/W
	Rx Port	68 °C/W	86 °C/W
Continuous Dissipated Power	Tx Port	1.12 W	1.12 W
	Rx Port	73 mW	232 mW
Supply Voltage (Vdd)		+10V	
Control Voltage Range (Vctl)		-0.2 to Vdd + 1V	
Storage Temperature		-65 to +150 °C	
Operating Temperature		-40 to +85 °C	
ESD Sensitivity (HBM)		Class 1A	

[1] Do not "hot switch" power levels greater than +24 dBm.  
[2] Max input power can be higher for duty cycle <100%

### Truth Table

Control Input Vctl (V)	Signal Path State	
	RFC To Tx	RFC to Rx
0.0	OFF	ON
Vdd	ON	OFF

Vdd = +3V to +8V  
Control Input Voltage Tolerances are ± 0.2 Vdc.

DC blocking capacitors are required at ports RFC, Tx and Rx.



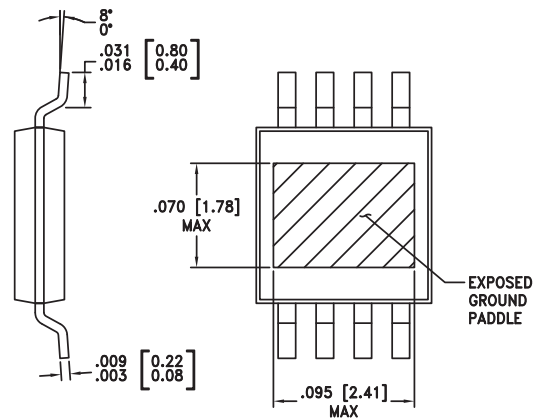
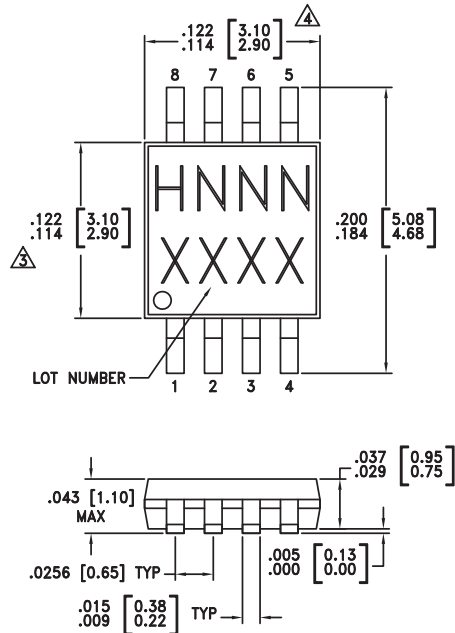

**ELECTROSTATIC SENSITIVE DEVICE  
OBSERVE HANDLING PRECAUTIONS**

### Outline Drawing



#### NOTES:

- LEADFRAME MATERIAL: COPPER ALLOY
- DIMENSIONS ARE IN INCHES [MILLIMETERS]
-  DIMENSION DOES NOT INCLUDE MOLDFLASH OF 0.15mm PER SIDE.
-  DIMENSION DOES NOT INCLUDE MOLDFLASH OF 0.25mm PER SIDE.
- ALL GROUND LEADS AND GROUND PADDLE MUST BE SOLDERED TO PCB RF GROUND.

### Package Information

Part Number	Package Body Material	Lead Finish	MSL Rating	Package Marking [3]
HMC546MS8G	Low Stress Injection Molding Plastic	Sn/Pb Solder	MSL1 [1]	H546 XXXX
HMC546MS8GE	RoHS-compliant Low Stress Injection Molding Plastic	100% matte Sn	MSL1 [2]	<u>H546</u> XXXX

[1] Max peak reflow temperature of 235 °C

[2] Max peak reflow temperature of 260 °C

[3] 4-Digit lot number XXXX

For price, delivery, and to place orders, please contact Hittite Microwave Corporation:  
20 Alpha Road, Chelmsford, MA 01824 Phone: 978-250-3343 Fax: 978-250-3373  
Order On-line at [www.hittite.com](http://www.hittite.com)

### Pin Descriptions

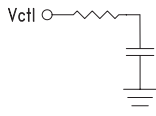
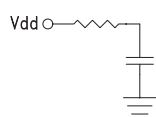
Pin Number	Function	Description	Interface Schematic
1	Tx	This pin is DC coupled and matched to 50 Ohms.	
2, 7	GND	This pin must be connected to PCB RF ground.	
3	Vctl	See Truth Table.	
4	ACG	External capacitor to ground is required. See application circuit herein.	
5	Rx	This pin is DC coupled and matched to 50 Ohms.	
6	Vdd	Supply Voltage	
8	RFC	This pin is DC coupled and matched to 50 Ohms.	

### Application Circuit

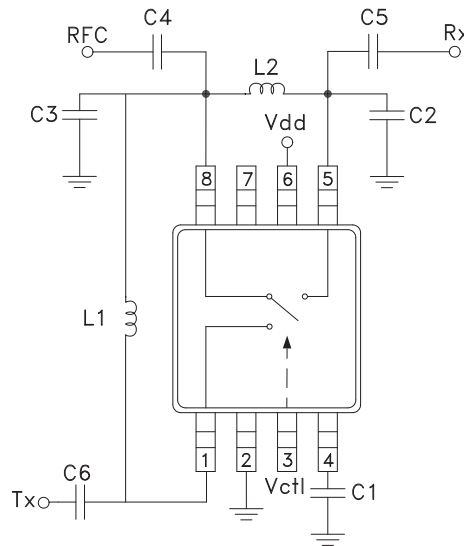

### Components for Selected Frequencies

Tuned Frequency	220 MHz	457 MHz	785 MHz	915 MHz	1843 MHz	1960 MHz	2015 MHz	2140 MHz
Evaluation PCB Number	110123	110124	110125	110126	110127	110128	115708	110129
C1	150 pF	33 pF	11 pF	8 pF	1.6 pF	1.5 pF	1.3 pF	1.2 pF
C2	12 pF	6.2 pF	2 pF	1.8 pF	N/A	N/A	N/A	N/A
C3	12 pF	7 pF	3 pF	2.7 pF	1 pF	1 pF	0.9 pF	1 pF
C4-C6 [1]	1000pF	1000pF	1000pF	1000pF	1000pF	1000pF	1000pF	1000pF
L1	390 nH [2]	100 nH [4]	33 nH [4]	23 nH [3]	3.3 nH [3]	2.4 nH [3]	2.2 nH [3]	1 nH [3]
L2	36 nH [3]	15 nH [3]	10 nH [3]	8.2 nH [3]	3.9 nH [3]	3.6 nH [3]	3.6 nH [3]	2.7 nH [4]

[1] DC blocking capacitors

[2] Coilcraft 0603LS series inductor, 5% tolerance

[3] Coilcraft 0402CS series inductor, 5% tolerance

[4] Toko LL1005-FH series inductor, 5% tolerance



### Evaluation PCB

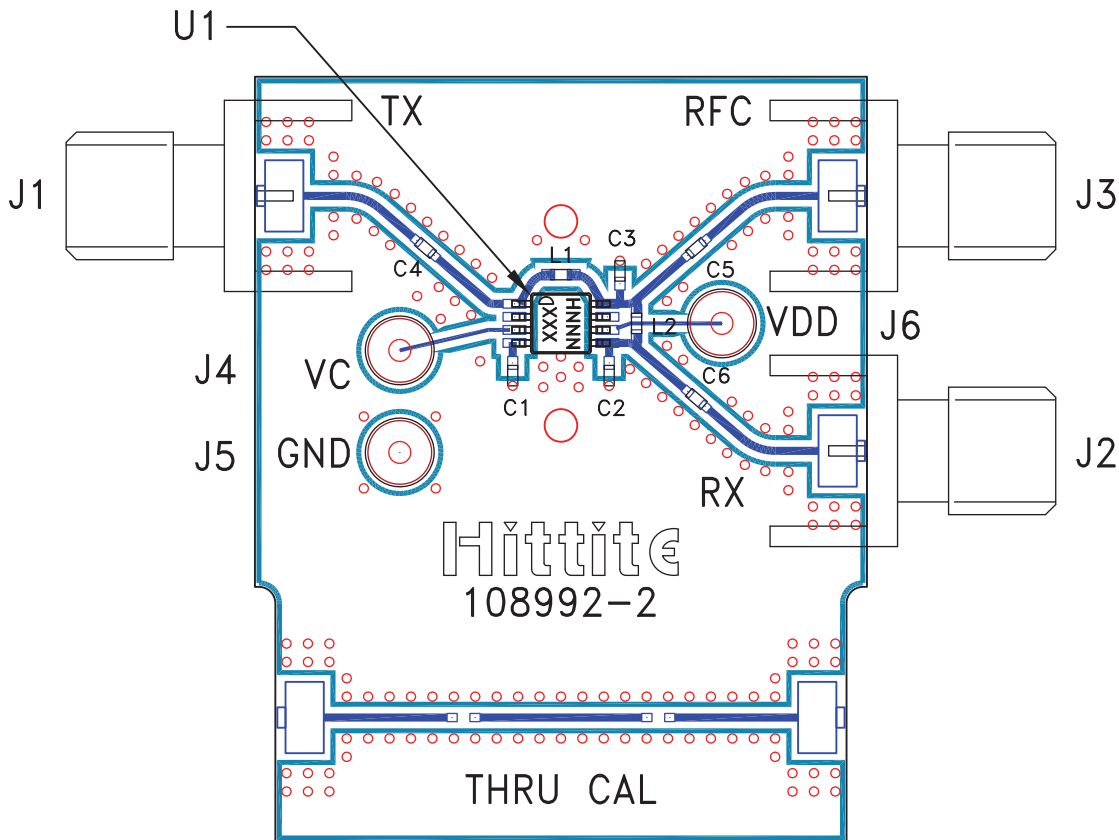

### List of Materials for Evaluation PCB [3]

Item	Description
J1 - J3	PCB Mount SMA RF Connector
J4 - J6	DC Pin
C1 - C6 [1]	Capacitor, 0402 Pkg.
L1 - L2 [1]	Inductor, 0402 Pkg.
U1	HMC546MS8G / HMC546MS8GE T/R Switch
PCB [2]	108992 Evaluation PCB

[1] Please refer to "Components for Selected Frequencies" table for values.

[2] Circuit Board Material: Rogers 4350

[3] When requesting an evaluation board, please reference the appropriate evaluation PCB number listed in the table "Components for Selected Frequencies."

The circuit board used in the application should be generated with proper RF circuit design techniques. Signal lines at the RF port should have 50 Ohm impedance and the package ground leads and exposed paddle should be connected directly to the ground plane similar to that shown above. The evaluation circuit board shown above is available from Hittite Microwave Corporation upon request.

## Данный компонент на территории Российской Федерации

### Вы можете приобрести в компании MosChip.

Для оперативного оформления запроса Вам необходимо перейти по данной ссылке:

<http://moschip.ru/get-element>

Вы можете разместить у нас заказ для любого Вашего проекта, будь то серийное производство или разработка единичного прибора.

В нашем ассортименте представлены ведущие мировые производители активных и пассивных электронных компонентов.

Нашей специализацией является поставка электронной компонентной базы двойного назначения, продукции таких производителей как XILINX, Intel (ex.ALTERA), Vicor, Microchip, Texas Instruments, Analog Devices, Mini-Circuits, Amphenol, Glenair.

Сотрудничество с глобальными дистрибьюторами электронных компонентов, предоставляет возможность заказывать и получать с международных складов практически любой перечень компонентов в оптимальные для Вас сроки.

На всех этапах разработки и производства наши партнеры могут получить квалифицированную поддержку опытных инженеров.

Система менеджмента качества компании отвечает требованиям в соответствии с ГОСТ Р ИСО 9001, ГОСТ РВ 0015-002 и ЭС РД 009

### Офис по работе с юридическими лицами:

105318, г.Москва, ул.Щербаковская д.3, офис 1107, 1118, ДЦ «Щербаковский»

Телефон: +7 495 668-12-70 (многоканальный)

Факс: +7 495 668-12-70 (доб.304)

E-mail: [info@moschip.ru](mailto:info@moschip.ru)

Skype отдела продаж:

moschip.ru

moschip.ru\_4

moschip.ru\_6

moschip.ru\_9