









## EE-SX198/199/1018/1025/1041/1042/1070/1071

Miniature Transmissive  
Photomicrosensor with 2- to 8-mm  
Slot Width and Phototransistor  
Output

- Stable sensing at temperatures as high as 95°C (EE-SX1041, EE-SX1070)
- Compact model with a 5-mm wide slot (EE-SX1041)
- Model with 12-mm deep and 5-mm wide slot (EE-SX1042)
- Miniature model with a 2-mm wide slot (EE-SX1018)
- Low-profile model (5.4 mm high) with a 2.8-mm slot width (EE-SX1025)



### Ordering Information

Appearance	Sensing method	Slot width	Slot depth	Sensing object	Output configuration	Weight	Part number	
	Transmissive	2 mm	4.5 mm	Opaque, 0.5 x 1.5 mm min.	Phototransistor	Approx. 0.2 g	EE-SX1018	
		2.8 mm	4.4 mm				EE-SX1025	
		3 mm	7.5 mm	Opaque, 0.5 x 2 mm min.		Approx. 0.6 g	EE-SX198	
							EE-SX199	
		3.4 mm	7.2 mm				EE-SX1071	
		5 mm	8.2 mm	Opaque, 0.5 x 2.2 mm min.				EE-SX1041
		5 mm	12 mm	Opaque, 0.5 x 2 mm min.			Approx. 0.8 g	EE-SX1042
		8 mm	8.2 mm	Opaque, 0.5 x 2.2 mm min.			Approx. 0.6 g	EE-SX1070

# Specifications

## ■ ABSOLUTE MAXIMUM RATINGS (T<sub>A</sub> = 25°C (77°F))

Item	Symbol	Rated value
Emitter	Forward current	I <sub>F</sub> 50 mA*
	Reverse voltage	V <sub>R</sub> 4 V
Detector	Collector-emitter voltage	V <sub>CEO</sub> 30 V
	Collector current	I <sub>C</sub> 20 mA
	Collector dissipation	P <sub>C</sub> 100 mW*
Ambient temperature	Operating	Topr -25°C to 85°C (-13°F to 185°F)**
	Storage	Tstg -30°C to 100°C (-22°F to 212°F)

\*Refer to Engineering Data if the ambient temperature is not within the normal room temperature range.

\*\*The operating temperature of the EE-SX1041/1070 is -25° to 95°C (-13°F to 203°F).

## ■ CHARACTERISTICS (T<sub>A</sub> = 25°C (77°F))

Item	Symbol	EE-SX1018/1025/1041/1042/1070/1071		EE-SX198/199	
		Value	Condition	Value	Condition
Emitter	Forward voltage	V <sub>F</sub> 1.2 V typ. 1.5 V max.	I <sub>F</sub> = 30 mA	1.2 V typ. 1.4 V max.	I <sub>F</sub> = 20 mA
	Reverse current	I <sub>R</sub> 0.01 μA typ. 10 μA max.	V <sub>R</sub> = 4 V	0.01 μA typ. 10 μA max.	V <sub>R</sub> = 4 V
	Peak emission wavelength	λ <sub>p(L)</sub> 940 nm typ.	I <sub>F</sub> = 20 mA	940 nm typ.	I <sub>F</sub> = 20 mA
Detector	Dark current	I <sub>D</sub> 2 nA typ. 200 nA max.	V <sub>CE</sub> = 10 V 0/x	2 nA typ. 200 nA max.	V <sub>CE</sub> = 10 V 0/x
	Peak spectral sensitivity wavelength	λ <sub>p(P)</sub> 850 nm typ.	V <sub>CE</sub> = 10 V	850 nm typ.	V <sub>CE</sub> = 10 V
Combination	Light current (collector current)	I <sub>L</sub> 0.5 mA min. 14 mA max.	I <sub>F</sub> = 20 mA V <sub>CE</sub> = 10 V	0.5 mA min. 14 mA max.	I <sub>F</sub> = 20 mA V <sub>CE</sub> = 5 V
	Collector-emitter saturated voltage	V <sub>CE (sat)</sub> 0.1 V typ. 0.4 V max.	I <sub>F</sub> = 20 mA I <sub>L</sub> = 0.1 mA	0.1 V typ. 0.4 V max.	I <sub>F</sub> = 40 mA I <sub>L</sub> = 0.5 mA
	Rising time (See Note.)	t <sub>r</sub> 4 μs typ.	V <sub>CC</sub> = 5 V R <sub>L</sub> = 100 Ω I <sub>L</sub> = 5 mA	4 μs typ.	V <sub>CC</sub> = 5 V R <sub>L</sub> = 100 Ω I <sub>L</sub> = 5 mA
	Falling time (See Note.)	t <sub>f</sub> 4 μs typ.		4 μs typ.	

Note: The following illustrations show the rising time, t<sub>r</sub>, and the falling time, t<sub>f</sub>.



# Engineering Data

Note: The operating conditions of the photomicrosensor must be within the absolute maximum rating ranges.

## TEMPERATURE CHARACTERISTICS

EE-SX198/199/1018/1025/1042/1071



EE-SX1070/1041



## INPUT CHARACTERISTICS (TYPICAL)



## DARK CURRENT TEMPERATURE DEPENDENCY (TYPICAL)



## SWITCHING CHARACTERISTICS (TYPICAL)

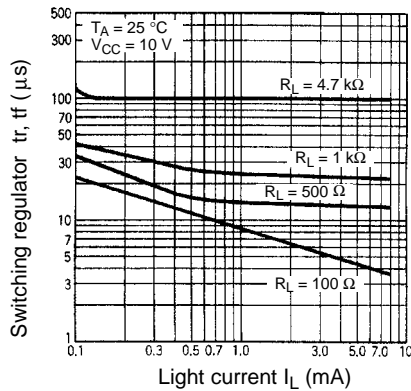

## I/O CHARACTERISTIC (TYPICAL)

EE-SX1018/1025



**EE-SX198/199**



**EE-SX1041/1042/1070/1071**



**OUTPUT CHARACTERISTICS (TYPICAL)**

**EE-SX198/199/1041/1042/1070/1071**



**EE-SX1018/1025**



**LIGHT CURRENT TEMPERATURE DEPENDENCY (TYPICAL)**

**EE-SX198/199**



**EE-SX1018/1025**



**EE-SX1041/1042/1070/1071**



■ **SENSING POSITION CHARACTERISTICS (TYPICAL)**

**EE-SX198/199**



**EE-SX1018**



**EE-SX1025**



**EE-SX1041**



**EE-SX1042**



**EE-SX1070/1071**



# Dimensions

Unit: mm (inch)

## EE-SX198



## EE-SX199



## EE-SX1018



■ EE-SX1025

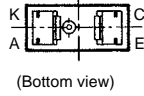
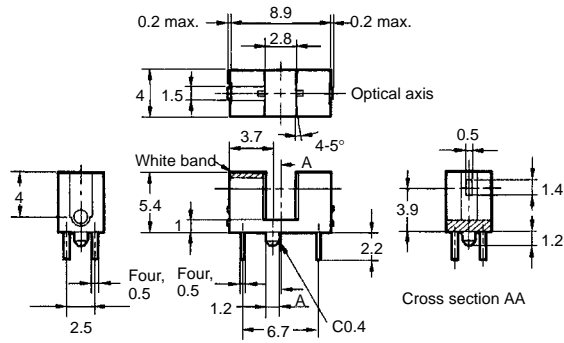
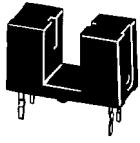

■ EE-SX1041

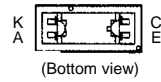
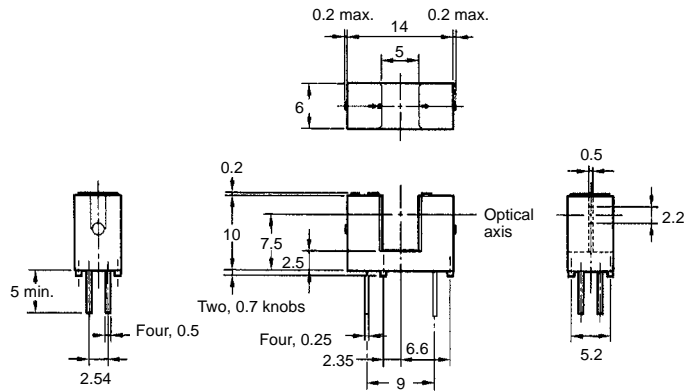

■ EE-SX1042

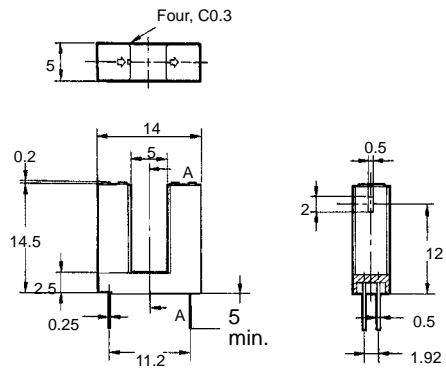

Cross section AA

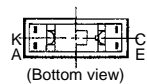

■ EE-SX1070

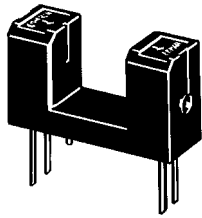

■ EE-SX1071

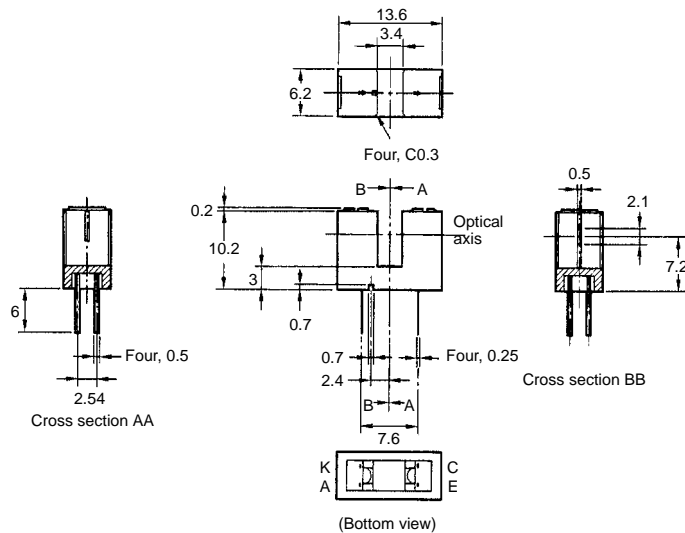
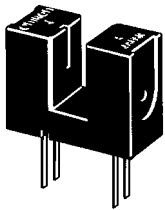

## Precautions

Refer to the Technical Information Section for general precautions.

**NOTE: DIMENSIONS SHOWN ARE IN MILLIMETERS. To convert millimeters to inches divide by 25.4.**

**OMRON**<sup>®</sup>  
**OMRON ELECTRONICS, INC.**  
 One East Commerce Drive  
 Schaumburg, IL 60173  
**1-800-55-OMRON**

**OMRON CANADA, INC.**  
 885 Milner Avenue  
 Scarborough, Ontario M1B 5V8  
**416-286-6465**



## Данный компонент на территории Российской Федерации

### Вы можете приобрести в компании MosChip.

Для оперативного оформления запроса Вам необходимо перейти по данной ссылке:

<http://moschip.ru/get-element>

Вы можете разместить у нас заказ для любого Вашего проекта, будь то серийное производство или разработка единичного прибора.

В нашем ассортименте представлены ведущие мировые производители активных и пассивных электронных компонентов.

Нашей специализацией является поставка электронной компонентной базы двойного назначения, продукции таких производителей как XILINX, Intel (ex.ALTERA), Vicor, Microchip, Texas Instruments, Analog Devices, Mini-Circuits, Amphenol, Glenair.

Сотрудничество с глобальными дистрибьюторами электронных компонентов, предоставляет возможность заказывать и получать с международных складов практически любой перечень компонентов в оптимальные для Вас сроки.

На всех этапах разработки и производства наши партнеры могут получить квалифицированную поддержку опытных инженеров.

Система менеджмента качества компании отвечает требованиям в соответствии с ГОСТ Р ИСО 9001, ГОСТ РВ 0015-002 и ЭС РД 009

### Офис по работе с юридическими лицами:

105318, г.Москва, ул.Щербаковская д.3, офис 1107, 1118, ДЦ «Щербаковский»

Телефон: +7 495 668-12-70 (многоканальный)

Факс: +7 495 668-12-70 (доб.304)

E-mail: [info@moschip.ru](mailto:info@moschip.ru)

Skype отдела продаж:

moschip.ru

moschip.ru\_4

moschip.ru\_6

moschip.ru\_9