

TUHS3

TUH S 3 F 05

① ② ③ ④ ⑤



- ① Series name
- ② Single output
- ③ Output wattage
- ④ Universal Input
- ⑤ Output voltage

□ Class II

* Avoid short circuit between +BC and -BC. It may cause the failure of inside components.
 * To use TUHS, external components are required. Refer to the instruction manual for details.

MODEL	TUHS3F05	TUHS3F12	TUHS3F24
MAX OUTPUT WATTAGE[W]	3.00	3.00	3.12
DC OUTPUT	5V 0.6A	12V 0.25A	24V 0.13A

SPECIFICATIONS

	MODEL	TUHS3F05	TUHS3F12	TUHS3F24	
INPUT	VOLTAGE[V]	AC85 - 264 1 φ DC120 - 370			
	CURRENT[A]	ACIN 100V	0.08typ (Io=100%)		
		ACIN 200V	0.05typ (Io=100%)		
	FREQUENCY[Hz]	50/60 (47 - 63)			
	EFFICIENCY[%]	ACIN 100V	79typ	81typ	81typ
		ACIN 200V	78typ	79typ	79typ
INRUSH CURRENT	Limited by external components				
LEAKAGE CURRENT[ma]	0.40/0.75 max (ACIN100V/240V , 60Hz, Io=100% , According to IEC60950-1)				
OUTPUT	VOLTAGE[V]	5	12	24	
	CURRENT[A]	0.6	0.25	0.13	
	LINE REGULATION[mV]	20max	48max	96max	
	LOAD REGULATION[mV]	40max	100max	150max	
	RIPPLE[mVp-p]	30 to 100% Load *1	120max	160max	200max
		0 to 30% Load AC85V - 240V *1	400max	480max	580max
	RIPPLE NOISE[mVp-p]	30 to 100% Load *1	160max	200max	240max
		0 to 30% Load AC85V - 240V *1	480max	560max	660max
	TEMPERATURE REGULATION[mV]	0 to +85°C	100max	180max	360max
		-40 to +85°C	150max	270max	480max
DRIFT[mV]	*2	20max	48max	96max	
OUTPUT VOLTAGE SETTING[V]	4.90 - 5.30	11.40 - 12.60	23.00 - 25.00		
PROTECTION CIRCUIT AND OTHERS	OVERCURRENT PROTECTION	Works over 105% of rating and recover automatically			
	OVERVOLTAGE PROTECTION[V]	5.50 - 8.00	13.20 - 19.20	26.40 - 38.40	
ISOLATION	INPUT-OUTPUT	AC3,000V 1minute, Cutoff current = 10mA, DC500V 50MΩ min (20±15°C)			
ENVIRONMENT	OPERATING TEMP., HUMID. AND ALTITUDE	-40 to +85°C, 20 - 95%RH (Non condensing) (Refer to DERATING CURVE), 3,000m (10,000 feet) max			
	STORAGE TEMP., HUMID. AND ALTITUDE	-40 to +100°C, 20 - 95%RH (Non condensing), 9,000m (30,000 feet) max			
	VIBRATION	10 - 55Hz, 49.0m/s ² (5G), 3minutes period, 60minutes each along X, Y and Z axis			
	IMPACT	196.1m/s ² (20G), 11ms, once each along X, Y and Z axis			
SAFETY AND NOISE REGULATIONS	AGENCY APPROVALS	UL60950-1, C-UL (CSA60950-1), EN60950-1			
	CONDUCTED NOISE	Complies with FCC-B, VCCI-B, CISPR-B, EN55022-B *3			
	HARMONIC ATTENUATOR	Complies with IEC61000-3-2 (Class A) (Not built-in to active filter)			
OTHERS	CASE SIZE/WEIGHT	28.7 X 12.7 X 17.5mm [1.13 X 0.50 X 0.69 inches] (W X H X D) / 15g max			
	COOLING METHOD	Convection / Forced air			

*1 Refer to instruction manual for measuring method of electric characteristics.
 *2 Drift is the change in DC output for an eight hour period after a half-hour warm-up at 25°C, with the input voltage held constant at the rated value.
 *3 Do not ground secondly circuit, in case of a standard adapted.
 * Measured with 18μF capacitor as Cbc.

External view

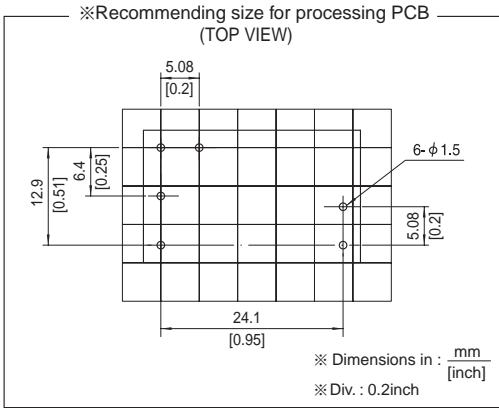
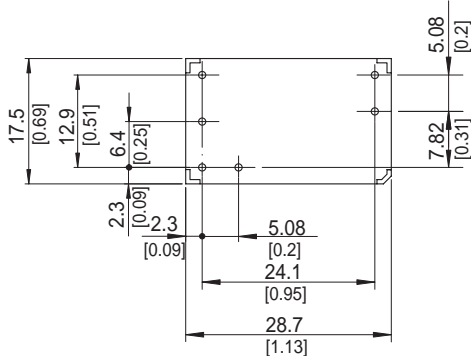
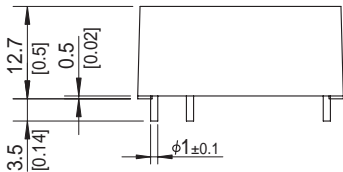
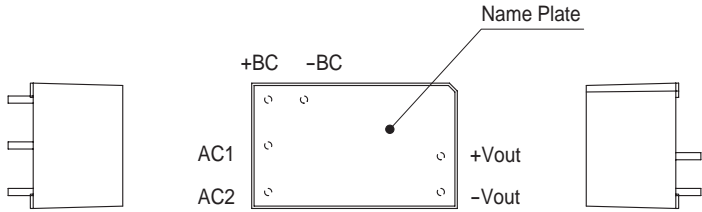

- ※ Tolerance : ± 0.5 [± 0.02]
- ※ Weight : 15g max
- ※ Case material : PBT
- ※ Pin material : Copper
- ※ Plating treatment of pin : Lead free plating
- ※ Dimensions in mm, []=inches

TUHS5

TUH S 5 F 05

① ② ③ ④ ⑤

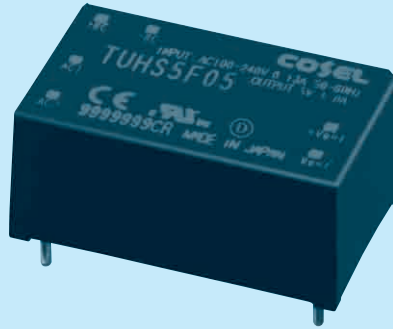

- ① Series name
- ② Single output
- ③ Output wattage
- ④ Universal Input
- ⑤ Output voltage

□ Class II

* Avoid short circuit between +BC and -BC. It may cause the failure of inside components.
 * To use TUHS, external components are required. Refer to the instruction manual for details.

MODEL	TUHS5F05	TUHS5F12	TUHS5F24
MAX OUTPUT WATTAGE[W]	5.00	5.40	5.28
DC OUTPUT	5V 1A	12V 0.45A	24V 0.22A

SPECIFICATIONS

	MODEL	TUHS5F05	TUHS5F12	TUHS5F24	
INPUT	VOLTAGE[V]	AC85 - 264 1 φ DC120 - 370			
	CURRENT[A]	ACIN 100V	0.13typ (Io=100%)		
		ACIN 200V	0.08typ (Io=100%)		
	FREQUENCY[Hz]	50/60 (47 - 63)			
	EFFICIENCY[%]	ACIN 100V	78typ	82typ	83typ
		ACIN 200V	79typ	82typ	83typ
INRUSH CURRENT	Limited by external components				
LEAKAGE CURRENT[ma]	0.40/0.75 max (ACIN100V/240V , 60Hz, Io=100% , According to IEC60950-1)				
OUTPUT	VOLTAGE[V]	5	12	24	
	CURRENT[A]	1	0.45	0.22	
	LINE REGULATION[mV]	20max	48max	96max	
	LOAD REGULATION[mV]	40max	100max	150max	
	RIPPLE[mVp-p]	30 to 100% Load *1	120max	160max	200max
		0 to 30% Load AC85V - 240V *1	400max	480max	580max
	RIPPLE NOISE[mVp-p]	30 to 100% Load *1	160max	200max	240max
		0 to 30% Load AC85V - 240V *1	480max	560max	660max
	TEMPERATURE REGULATION[mV]	0 to +80°C	100max	180max	360max
		-40 to +80°C	150max	270max	480max
DRIFT[mV]	*2	20max	48max	96max	
OUTPUT VOLTAGE SETTING[V]	4.90 - 5.30	11.40 - 12.60	23.00 - 25.00		
PROTECTION CIRCUIT AND OTHERS	OVERCURRENT PROTECTION	Works over 105% of rating and recover automatically			
	OVERVOLTAGE PROTECTION[V]	5.50 - 8.00	13.20 - 19.20	26.40 - 38.40	
ISOLATION	INPUT-OUTPUT	AC3,000V 1minute, Cutoff current = 10mA, DC500V 50MΩ min (20±15°C)			
ENVIRONMENT	OPERATING TEMP., HUMID. AND ALTITUDE	-40 to +85°C, 20 - 95%RH (Non condensing) (Refer to DERATING CURVE), 3,000m (10,000 feet) max			
	STORAGE TEMP., HUMID. AND ALTITUDE	-40 to +100°C, 20 - 95%RH (Non condensing), 9,000m (30,000 feet) max			
	VIBRATION	10 - 55Hz, 49.0m/s ² (5G), 3minutes period, 60minutes each along X, Y and Z axis			
	IMPACT	196.1m/s ² (20G), 11ms, once each along X, Y and Z axis			
SAFETY AND NOISE REGULATIONS	AGENCY APPROVALS	UL60950-1, C-UL (CSA60950-1), EN60950-1			
	CONDUCTED NOISE	Complies with FCC-B, VCCI-B, CISPR-B, EN55022-B *3			
	HARMONIC ATTENUATOR	Complies with IEC61000-3-2 (Class A) (Not built-in to active filter)			
OTHERS	CASE SIZE/WEIGHT	28.7 X 12.7 X 17.5mm [1.13 X 0.50 X 0.69 inches] (W X H X D) / 15g max			
	COOLING METHOD	Convection / Forced air			

*1 Refer to instruction manual for measuring method of electric characteristics.
 *2 Drift is the change in DC output for an eight hour period after a half-hour warm-up at 25°C, with the input voltage held constant at the rated value.
 *3 Do not ground secondly circuit, in case of a standard adapted.
 * Measured with 22μF capacitor as Cbc.

External view

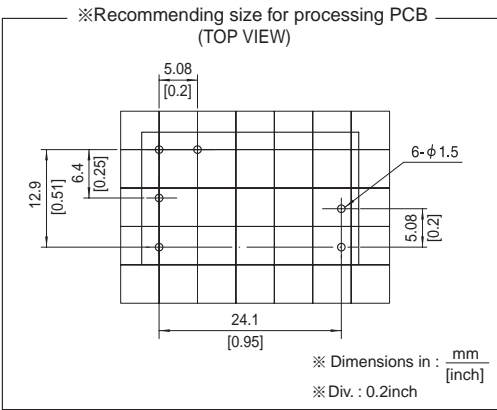
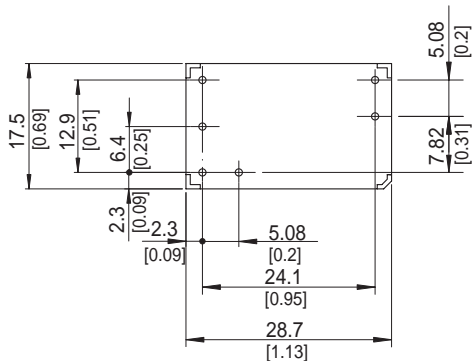
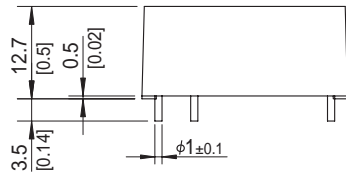

- ※ Tolerance : ± 0.5 [± 0.02]
- ※ Weight : 15g max
- ※ Case material : PBT
- ※ Pin material : Copper
- ※ Plating treatment of pin : Lead free plating
- ※ Dimensions in mm, []=inches

TUHS10

TUH S 10 F 05

① ② ③ ④ ⑤

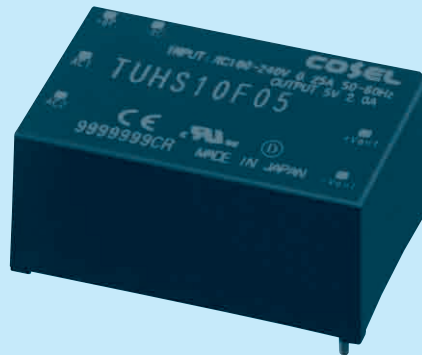

- ① Series name
- ② Single output
- ③ Output wattage
- ④ Universal Input
- ⑤ Output voltage

□ Class II

* Avoid short circuit between +BC and -BC. It may cause the failure of inside components.
 * To use TUHS, external components are required. Refer to the instruction manual for details.

MODEL	TUHS10F05	TUHS10F12	TUHS10F24
MAX OUTPUT WATTAGE[W]	10.00	10.80	10.80
DC OUTPUT	5V 2A	12V 0.9A	24V 0.45A

SPECIFICATIONS

	MODEL	TUHS10F05	TUHS10F12	TUHS10F24	
INPUT	VOLTAGE[V]	AC85 - 264 1φ DC120 - 370			
	CURRENT[A]	ACIN 100V	0.25typ (Io=100%)		
		ACIN 200V	0.14typ (Io=100%)		
	FREQUENCY[Hz]	50/60 (47 - 63)			
	EFFICIENCY[%]	ACIN 100V	81typ	85typ	86typ
		ACIN 200V	82typ	85typ	87typ
INRUSH CURRENT	Limited by external components				
LEAKAGE CURRENT[ma]	0.40/0.75 max (ACIN100V/240V , 60Hz, Io=100% , According to IEC60950-1)				
OUTPUT	VOLTAGE[V]	5	12	24	
	CURRENT[A]	2	0.9	0.45	
	LINE REGULATION[mV]	20max	48max	96max	
	LOAD REGULATION[mV]	40max	100max	150max	
	RIPPLE[mVp-p]	30 to 100% Load *1	120max	160max	200max
		0 to 30% Load AC85V - 240V *1	400max	480max	580max
	RIPPLE NOISE[mVp-p]	30 to 100% Load *1	160max	200max	240max
		0 to 30% Load AC85V - 240V *1	480max	560max	660max
	TEMPERATURE REGULATION[mV]	0 to +70°C	100max	180max	360max
		-40 to +70°C	150max	270max	480max
DRIFT[mV]	*2	20max	48max	96max	
OUTPUT VOLTAGE SETTING[V]	4.90 - 5.30	11.40 - 12.60	23.00 - 25.00		
PROTECTION CIRCUIT AND OTHERS	OVERCURRENT PROTECTION	Works over 105% of rating and recover automatically			
	OVERVOLTAGE PROTECTION[V]	5.50 - 8.00	13.20 - 19.20	26.40 - 38.40	
ISOLATION	INPUT-OUTPUT	AC3,000V 1minute, Cutoff current = 10mA, DC500V 50MΩ min (20±15°C)			
ENVIRONMENT	OPERATING TEMP., HUMID. AND ALTITUDE	-40 to +85°C, 20 - 95%RH (Non condensing) (Refer to DERATING CURVE), 3,000m (10,000 feet) max			
	STORAGE TEMP., HUMID. AND ALTITUDE	-40 to +100°C, 20 - 95%RH (Non condensing), 9,000m (30,000 feet) max			
	VIBRATION	10 - 55Hz, 49.0m/s ² (5G), 3minutes period, 60minutes each along X, Y and Z axis			
	IMPACT	196.1m/s ² (20G), 11ms, once each along X, Y and Z axis			
SAFETY AND NOISE REGULATIONS	AGENCY APPROVALS	UL60950-1, C-UL (CSA60950-1), EN60950-1			
	CONDUCTED NOISE	Complies with FCC-B, VCCI-B, CISPR-B, EN55022-B *3			
	HARMONIC ATTENUATOR	Complies with IEC61000-3-2 (Class A) (Not built-in to active filter)			
OTHERS	CASE SIZE/WEIGHT	33.0 × 15.0 × 22.0mm [1.3 × 0.59 × 0.86 inches] (W × H × D) / 25g max			
	COOLING METHOD	Convection / Forced air			

*1 Refer to instruction manual for measuring method of electric characteristics.
 *2 Drift is the change in DC output for an eight hour period after a half-hour warm-up at 25°C, with the input voltage held constant at the rated value.
 *3 Do not ground secondly circuit, in case of a standard adapted.
 * Measured with 47μF capacitor as Cbc.

External view

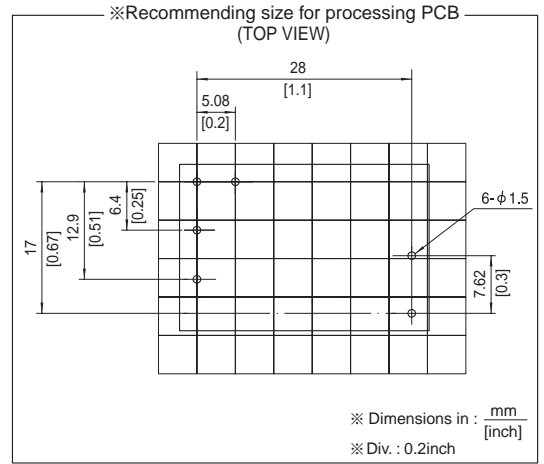
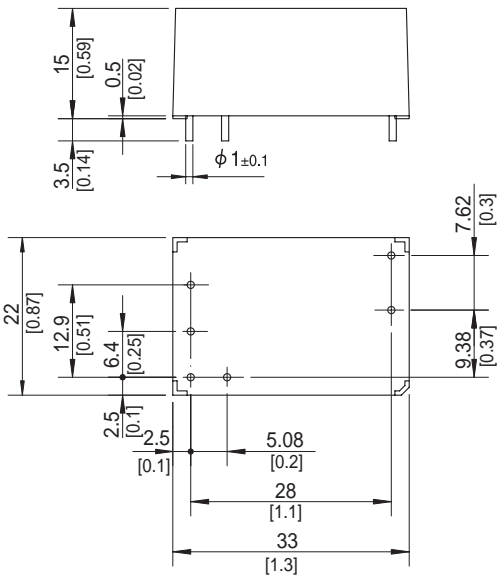

- ※ Dimensions in : $\frac{\text{mm}}{[\text{inch}]}$
- ※ Div. : 0.2inch
- ※ Tolerance : ± 0.5 [± 0.02]
- ※ Weight : 25g max
- ※ Case material : PBT
- ※ Pin material : Copper
- ※ Plating treatment of pin : Lead free plating
- ※ Dimensions in mm, []=inches

TUHS15

TUH S 15 F 12

① ② ③ ④ ⑤

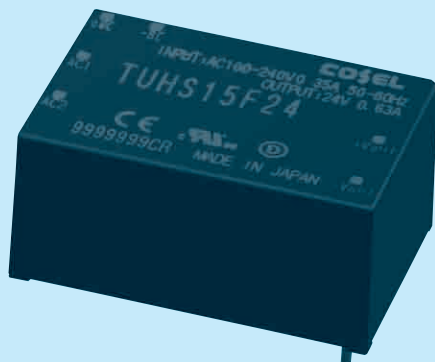

- ① Series name
- ② Single output
- ③ Output wattage
- ④ Universal Input
- ⑤ Output voltage

□ Class II

* Avoid short circuit between +BC and -BC. It may cause the failure of inside components.
 * To use TUHS, external components are required. Refer to the instruction manual for details.

MODEL	TUHS15F12	TUHS15F24
MAX OUTPUT WATTAGE[W]	15.00	15.12
DC OUTPUT	12V 1.25A	24V 0.63A

SPECIFICATIONS

	MODEL	TUHS15F12	TUHS15F24	
INPUT	VOLTAGE[V]	AC85 - 264 1 φ DC120 - 370		
	CURRENT[A]	ACIN 100V	0.35typ (Io=100%)	
		ACIN 200V	0.18typ (Io=100%)	
	FREQUENCY[Hz]	50/60 (47 - 63)		
	EFFICIENCY[%]	ACIN 100V	85typ	86typ
		ACIN 200V	85typ	87typ
INRUSH CURRENT	Limited by external components			
LEAKAGE CURRENT[ma]	0.40/0.75 max (ACIN100V/240V , 60Hz, Io=100% , According to IEC60950-1)			
OUTPUT	VOLTAGE[V]	12	24	
	CURRENT[A]	1.25	0.63	
	LINE REGULATION[mV]	48max	96max	
	LOAD REGULATION[mV]	100max	150max	
	RIPPLE[mVp-p]	30 to 100% Load *1	160max	200max
		0 to 30% Load AC85V - 240V *1	480max	580max
	RIPPLE NOISE[mVp-p]	30 to 100% Load *1	200max	240max
		0 to 30% Load AC85V - 240V *1	560max	660max
	TEMPERATURE REGULATION[mV]	0 to +50°C	180max	360max
		-40 to +50°C	270max	480max
DRIFT[mV]	*2	48max	96max	
OUTPUT VOLTAGE SETTING[V]	11.40 - 12.60	23.00 - 25.00		
PROTECTION CIRCUIT AND OTHERS	OVERCURRENT PROTECTION	Works over 105% of rating and recover automatically		
	OVERVOLTAGE PROTECTION[V]	13.20 - 19.20	26.40 - 38.40	
ISOLATION	INPUT-OUTPUT	AC3,000V 1minute, Cutoff current = 10mA, DC500V 50MΩ min (20±15°C)		
ENVIRONMENT	OPERATING TEMP., HUMID. AND ALTITUDE	-40 to +85°C , 20 - 95%RH (Non condensing) (Refer to DERATING CURVE) , 3,000m (10,000 feet) max		
	STORAGE TEMP., HUMID. AND ALTITUDE	-40 to +100°C , 20 - 95%RH (Non condensing) , 9,000m (30,000 feet) max		
	VIBRATION	10 - 55Hz, 49.0m/s ² (5G), 3minutes period, 60minutes each along X, Y and Z axis		
	IMPACT	196.1m/s ² (20G), 11ms, once each along X, Y and Z axis		
SAFETY AND NOISE REGULATIONS	AGENCY APPROVALS	UL60950-1, C-UL (CSA60950-1), EN60950-1		
	CONDUCTED NOISE	Complies with FCC-B, VCCI-B, CISPR-B, EN55022-B *3		
	HARMONIC ATTENUATOR	Complies with IEC61000-3-2 (Class A) (Not built-in to active filter)		
OTHERS	CASE SIZE/WEIGHT	33.0 × 15.0 × 22.0mm [1.3 × 0.59 × 0.86 inches] (W × H × D) / 25g max		
	COOLING METHOD	Convection / Forced air		

*1 Refer to instruction manual for measuring method of electric characteristics.
 *2 Drift is the change in DC output for an eight hour period after a half-hour warm-up at 25°C, with the input voltage held constant at the rated value.
 *3 Do not ground secondly circuit, in case of a standard adapted.
 * Measured with 68μF capacitor as Cbc.

External view

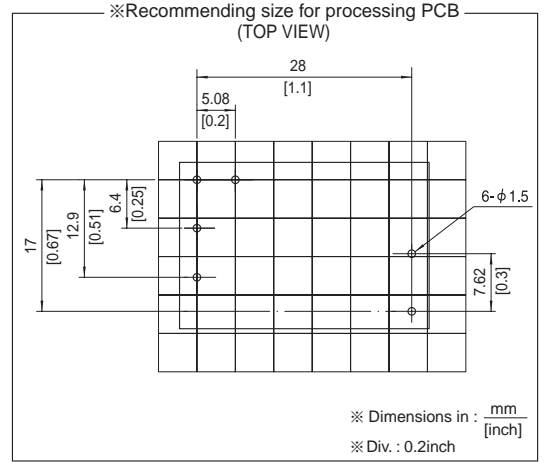
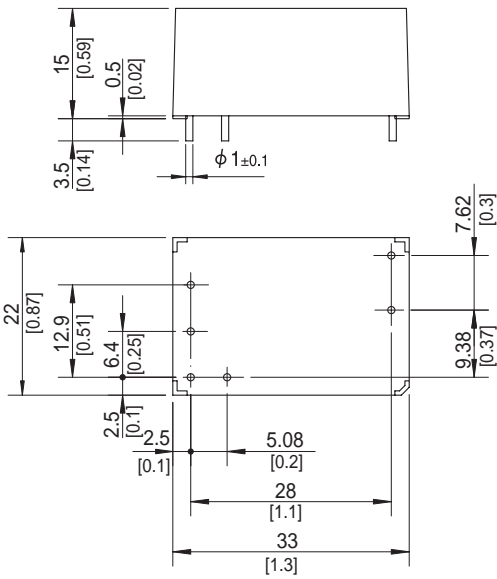

- ※ Tolerance : ± 0.5 [± 0.02]
- ※ Weight : 25g max
- ※ Case material : PBT
- ※ Pin material : Copper
- ※ Plating treatment of pin : Lead free plating
- ※ Dimensions in mm, []=inches

TUHS25

TUH S 25 F 05

① ② ③ ④ ⑤

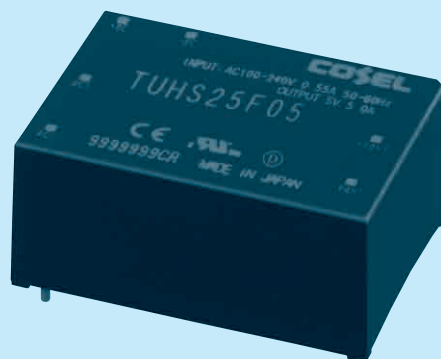

- ① Series name
- ② Single output
- ③ Output wattage
- ④ Universal Input
- ⑤ Output voltage

□ Class II

* Avoid short circuit between +BC and -BC. It may cause the failure of inside components.
 * To use TUHS, external components are required. Refer to the instruction manual for details.

MODEL	TUHS25F05	TUHS25F12	TUHS25F24
MAX OUTPUT WATTAGE[W]	25.00	25.20	26.40
DC OUTPUT	5V 5A	12V 2.1A	24V 1.1A

SPECIFICATIONS

	MODEL	TUHS25F05	TUHS25F12	TUHS25F24	
INPUT	VOLTAGE[V]	AC85 - 264 1 φ DC120 - 370			
	CURRENT[A]	ACIN 100V	0.55typ (Io=100%)		
		ACIN 200V	0.35typ (Io=100%)		
	FREQUENCY[Hz]	50/60 (47 - 63)			
	EFFICIENCY[%]	ACIN 100V	87typ	88typ	89typ
		ACIN 200V	87typ	88typ	90typ
INRUSH CURRENT	Limited by external components				
LEAKAGE CURRENT[ma]	0.40/0.75 max (ACIN100V/240V , 60Hz, Io=100% , According to IEC60950-1)				
OUTPUT	VOLTAGE[V]	5	12	24	
	CURRENT[A]	5	2.1	1.1	
	LINE REGULATION[mV]	20max	48max	96max	
	LOAD REGULATION[mV]	40max	100max	150max	
	RIPPLE[mVp-p]	30 to 100% Load *1	120max	160max	200max
		0 to 30% Load AC85V - 240V *1	400max	480max	580max
	RIPPLE NOISE[mVp-p]	30 to 100% Load *1	160max	200max	240max
		0 to 30% Load AC85V - 240V *1	480max	560max	660max
	TEMPERATURE REGULATION[mV]	0 to +50°C	100max	180max	360max
-40 to +50°C		150max	270max	480max	
DRIFT[mV]	*2	20max	48max	96max	
OUTPUT VOLTAGE SETTING[V]	4.90 - 5.30	11.40 - 12.60	23.00 - 25.00		
PROTECTION CIRCUIT AND OTHERS	OVERCURRENT PROTECTION	Works over 105% of rating and recover automatically			
	OVERVOLTAGE PROTECTION[V]	5.50 - 8.00	13.20 - 19.20	26.40 - 38.40	
ISOLATION	INPUT-OUTPUT	AC3,000V 1minute, Cutoff current = 10mA, DC500V 50MΩ min (20±15°C)			
ENVIRONMENT	OPERATING TEMP., HUMID. AND ALTITUDE	-40 to +85°C, 20 - 95%RH (Non condensing) (Refer to DERATING CURVE), 3,000m (10,000 feet) max			
	STORAGE TEMP., HUMID. AND ALTITUDE	-40 to +100°C, 20 - 95%RH (Non condensing), 9,000m (30,000 feet) max			
	VIBRATION	10 - 55Hz, 49.0m/s ² (5G), 3minutes period, 60minutes each along X, Y and Z axis			
	IMPACT	196.1m/s ² (20G), 11ms, once each along X, Y and Z axis			
SAFETY AND NOISE REGULATIONS	AGENCY APPROVALS	UL60950-1, C-UL (CSA60950-1), EN60950-1			
	CONDUCTED NOISE	Complies with FCC-B, VCCI-B, CISPR-B, EN55022-B *3			
	HARMONIC ATTENUATOR	Complies with IEC61000-3-2 (Class A) (Not built-in to active filter)			
OTHERS	CASE SIZE/WEIGHT	36.0 X 16.5 X 25.4mm [1.42 X 0.65 X 1.0 inches] (W X H X D) / 40g max			
	COOLING METHOD	Convection / Forced air			

*1 Refer to instruction manual for measuring method of electric characteristics.
 *2 Drift is the change in DC output for an eight hour period after a half-hour warm-up at 25°C, with the input voltage held constant at the rated value.
 *3 Do not ground secondly circuit, in case of a standard adapted.
 * Measured with 120μF capacitor as Cbc.

External view

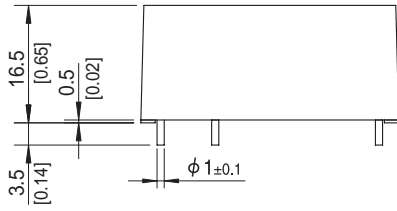

- ※ Tolerance : ± 0.5 [± 0.02]
- ※ Weight : 40g max
- ※ Case material : PBT
- ※ Pin material : Copper
- ※ Plating treatment of pin : Lead free plating
- ※ Dimensions in mm, []=inches

Mouser Electronics

Authorized Distributor

Click to View Pricing, Inventory, Delivery & Lifecycle Information:

[Cosel:](#)

[TUHS3F24](#) [TUHS5F24](#) [TUHS3F12](#) [TUHS25F24](#) [TUHS5F12](#) [TUHS10F24](#) [TUHS10F12](#) [TUHS10F05](#) [TUHS5F05](#)
[TUHS3F05](#) [TUHS25F12](#) [TUHS25F05](#) [TUHS15F24](#) [TUHS15F12](#)

Данный компонент на территории Российской Федерации

Вы можете приобрести в компании MosChip.

Для оперативного оформления запроса Вам необходимо перейти по данной ссылке:

<http://moschip.ru/get-element>

Вы можете разместить у нас заказ для любого Вашего проекта, будь то серийное производство или разработка единичного прибора.

В нашем ассортименте представлены ведущие мировые производители активных и пассивных электронных компонентов.

Нашей специализацией является поставка электронной компонентной базы двойного назначения, продукции таких производителей как XILINX, Intel (ex.ALTERA), Vicor, Microchip, Texas Instruments, Analog Devices, Mini-Circuits, Amphenol, Glenair.

Сотрудничество с глобальными дистрибьюторами электронных компонентов, предоставляет возможность заказывать и получать с международных складов практически любой перечень компонентов в оптимальные для Вас сроки.

На всех этапах разработки и производства наши партнеры могут получить квалифицированную поддержку опытных инженеров.

Система менеджмента качества компании отвечает требованиям в соответствии с ГОСТ Р ИСО 9001, ГОСТ РВ 0015-002 и ЭС РД 009

Офис по работе с юридическими лицами:

105318, г.Москва, ул.Щербаковская д.3, офис 1107, 1118, ДЦ «Щербаковский»

Телефон: +7 495 668-12-70 (многоканальный)

Факс: +7 495 668-12-70 (доб.304)

E-mail: info@moschip.ru

Skype отдела продаж:

moschip.ru

moschip.ru_4

moschip.ru_6

moschip.ru_9