

EAO – Your Expert Partner for
Human Machine Interfaces



EAO Product Information

Series 02



Description	3
Product Assembly	4
Devices raised mounting	5
Accessories.....	12
Technical Data.....	17
Typical Applications	19
Application guidelines.....	20
Marking	21
Drawings.....	22
Index.....	27

Product Information

General notes

The pushbuttons of series 02 are noteworthy for the robust design of their case, their operational reliability and the large marking and illuminated area. The pushbuttons contain one or two separately operating snap-action switching elements.

Switches with free choice of bezel

The free choice of bezel enables users to match switches to suit different purposes. These bezels protect against unintentional switching. Standard bezels can be obtained in black.

Mounting

The switches, which are pushed into the opening in the panel from the front, are fixed with a plastic sleeve with a maximum effort of 20 Ncm.

Lenses

The flat lenses, made of polymethyl methacrylate, are obtainable in various colours, as well as transparent and translucent. All lenses can be exchanged without affecting the switch position.

Marking

For further information about engraving, hot stamping and film inserts see part Marking.

Illumination

The T6.8 incandescent (filament) lamp (6...48 V, 1.2 W) ensures perfect illumination of the lenses, which are supplied in various colours.

T6.8 Single-LED (6, 12, 24, 28, 48 V) are also available in blue, green, red, white or yellow.

Luminosity and wave length scattering caused by the technology used in the LED manufacturing processes may lead to visual differences in our products.

For supply voltages above 48 V, it is necessary to use a voltage reduction element (external series resistor or transformer).

Keylock switch

Standard lock number is YB1. If the lock number is not specified, we will supply standard number YB1.

Additional 9 lock numbers are available on request.

Two keys are supplied with each keylock switch.

Spare keys for standard locks may be ordered by quoting Typ-Nr. 02-989.

Number structure

Nomenclature in accordance with ' IEC 61058 TEST REPORT '. The certification document we dispatch to them on demands.

Specimen order

Illuminated pushbutton :

- Illuminated pushbutton actuator, 24 x 36 mm, 2 change over contacts, momentary action, screw terminal 02-617.011

Essential accessories :

- Lens plastic colourless, transparent 02-902.5
- Holder farblos, transparent 02-908.5
- Diffusor plate 02-909
- Front bezel flush, black 02-967.0
- Single-LED, T6.8, 24 VDC, white diffuse 10-2K12.1079

*We reserve the right to modify technical data
All dimensions in mm*

Illuminated pushbutton

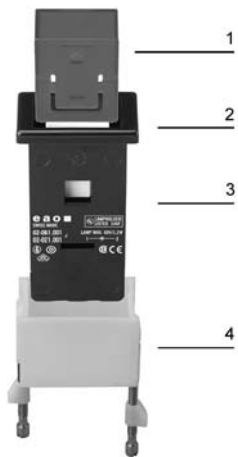







- 1 Lens
- 2 Front bezel
- 3 Switch housing
- 4 Fixing bezel

Indicator actuator



Essential Accessories:

-  Diffusor plate page 13
-  Front bezel flush page 13
-  Holder page 12
-  Lens page 12
-  Single-LED page 15

	Front protection	Terminals	□ 24 x 36 mm Typ-Nr.	Mounting dimensions	Technical drawing	Circuit drawing	
Indicator actuator reduced length, without built-in series resistor, for filament lamp or LED	IP 40	PT 2.8	02-021.002	1	1	2	0.030
		PT 4.8	02-021.003	1	1	2	0.030
		ST	02-021.001	1	1	2	0.030
with built-in lamp series resistor and diode, 230 VAC/DC to 48 V, 25 mA, for filament lamp	IP 40	PT 2.8	02-073.002	1	2	2	0.045
		PT 4.8	02-073.003	1	2	2	0.045
		ST	02-073.001	1	2	2	0.045
with built-in lamp series resistor, 110 VAC/DC to 48 V, 25 mA, for filament lamp	IP 40	PT 2.8	02-071.002	1	2	2	0.045
		PT 4.8	02-071.003	1	2	2	0.045
		ST	02-071.001	1	2	2	0.045
with built-in lamp series resistor, 125 VAC/DC to 48 V, 25 mA, for filament lamp	IP 40	PT 2.8	02-072.002	1	2	2	0.045
		PT 4.8	02-072.003	1	2	2	0.045
		ST	02-072.001	1	2	2	0.045
with built-in lamp series resistor, 230 VAC/DC to 48 V, 25 mA, for filament lamp	IP 40	PT 2.8	02-070.002	1	2	2	0.045
		PT 4.8	02-070.003	1	2	2	0.045
		ST	02-070.001	1	2	2	0.045

Please take note of heat generating !

Terminals: PT 2.8 = Plug-in terminal 2.8 mm, PT 4.8 = Plug-in terminal 4.8 mm, ST = Screw terminal

Mounting dimensions from page 22, Technical drawing from page 22, Circuit drawing from page 25

Buzzer



Essential Accessories:

 Front bezel raised page 13

	Front protection	Front cap	Terminals	□ 24 x 36 mm Typ-Nr.	Mounting dimensions	Technical drawing	Circuit drawing	
Buzzer Operating voltage 10 ... 55 VAC / 10 ... 75 VDC	IP 40	Pastic black	ST	02-810.001	1	3	1	0.060

Further information in the Technical Data and Typical Applications



Terminals: ST = Screw terminal



Mounting dimensions from page 22, Technical drawing from page 22, Circuit drawing from page 25

Pushbutton actuator



Essential Accessories:

-  Front bezel flush page 13
-  Lens page 12

	Front protection	Contacts	Switching action	Terminals	 24 x 36 mm Typ-Nr.	Mounting dimensions	Technical drawing	Circuit drawing	
Pushbutton actuator	IP 40	1 C	MA	PT 2.8	02-613.012	1	6	7	0.045
				PT 4.8	02-613.013	1	6	7	0.045
				ST	02-613.011	1	6	7	0.045
			M	PT 2.8	02-611.012	1	6	8	0.045
				PT 4.8	02-611.013	1	6	8	0.045
				ST	02-611.011	1	6	8	0.045
		2 C	MA	PT 2.8	02-614.012	1	6	4	0.050
				PT 4.8	02-614.013	1	6	4	0.050
				ST	02-614.011	1	6	4	0.050
			M	PT 4.8	02-612.013	1	6	9	0.050
				ST	02-612.011	1	6	9	0.050
			M-MA	PT 2.8	02-615.012	1	6	6	0.050
				PT 4.8	02-615.013	1	6	6	0.050
				ST	02-615.011	1	6	6	0.050

Contacts: C = Changeover

Switching action: MA = Maintained action, M = Momentary action, M-MA = Momentary action-Maintained action





Terminals: PT 2.8 = Plug-in terminal 2.8 mm, PT 4.8 = Plug-in terminal 4.8 mm, ST = Screw terminal



Mounting dimensions from page 22, Technical drawing from page 22, Circuit drawing from page 25

Illuminated pushbutton actuator



Essential Accessories:

-  Diffusor plate page 13
-  Front bezel flush page 13
-  Holder page 12
-  Lens page 12
-  Single-LED page 15

	Front protection	Contacts	Switching action	Terminals	 24 x 36 mm Typ-Nr.	Mounting dimensions	Technical drawing	Circuit drawing	
Illuminated pushbutton actuator	IP 40	1 C	MA	PT 2.8	02-618.012	1	6	3	0.050
				PT 4.8	02-618.013	1	6	3	0.050
				ST	02-618.011	1	6	3	0.050
			M	PT 2.8	02-616.012	1	6	10	0.050
				PT 4.8	02-616.013	1	6	10	0.050
				ST	02-616.011	1	6	10	0.050
		2 C	MA	PT 2.8	02-619.012	1	6	5	0.055
				PT 4.8	02-619.013	1	6	5	0.055
				ST	02-619.011	1	6	5	0.055
			M	PT 2.8	02-617.012	1	6	12	0.055
				PT 4.8	02-617.013	1	6	12	0.055
				ST	02-617.011	1	6	12	0.055
			M-MA	PT 2.8	02-620.012	1	6	11	0.055
				PT 4.8	02-620.013	1	6	11	0.055
				ST	02-620.011	1	6	11	0.055

Contacts: C = Changeover

Switching action: MA = Maintained action, M = Momentary action, M-MA = Momentary action-Maintained action



Terminals: PT 2.8 = Plug-in terminal 2.8 mm, PT 4.8 = Plug-in terminal 4.8 mm, ST = Screw terminal



Mounting dimensions from page 22, Technical drawing from page 22, Circuit drawing from page 25

Mushroom-head pushbutton actuator



Essential Accessories:

-  Front bezel flush page 13
-  Mushroom-head cap page 12

	Front protection	Contacts	Switching action	Terminals	 24 x 36 mm Typ-Nr.	Mounting dimensions	Technical drawing	Circuit drawing	
Mushroom-head pushbutton actuator	IP 40	1 C	MA	PT 2.8	02-613.012	1	9	7	0.045
				PT 4.8	02-613.013	1	9	7	0.045
				ST	02-613.011	1	9	7	0.045
			M	PT 2.8	02-611.012	1	9	8	0.045
				PT 4.8	02-611.013	1	9	8	0.045
				ST	02-611.011	1	9	8	0.045
		2 C	MA	PT 2.8	02-614.012	1	9	4	0.050
				PT 4.8	02-614.013	1	9	4	0.050
				ST	02-614.011	1	9	4	0.050
			M	PT 4.8	02-612.013	1	9	9	0.050
				ST	02-612.011	1	9	9	0.050
				M-MA	PT 2.8	02-615.012	1	9	6
			PT 4.8		02-615.013	1	9	6	0.050
			ST		02-615.011	1	9	6	0.050

Contacts: C = Changeover

Switching action: MA = Maintained action, M = Momentary action, M-MA = Momentary action-Maintained action

Terminals: PT 2.8 = Plug-in terminal 2.8 mm, PT 4.8 = Plug-in terminal 4.8 mm, ST = Screw terminal



Mounting dimensions from page 22, Technical drawing from page 22, Circuit drawing from page 25

Keylock switch actuator 2 positions

Note:
The keylock front bezel of the switch types 02-198.01x and 02-695.01x are factory-assembled and do not have to be ordered separately.



Essential Accessories:

-  Front bezel flush page 13
-  Keylock front bezel page 12

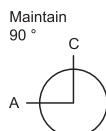

	Front protection	Contacts	Key remove	Terminals	□ 24 x 36 mm Typ-Nr.	Mounting dimensions	Technical drawing	Circuit drawing	
Keylock switch actuator 2 positions Position A : lockable, actuated Standard lock YB1 Front plastic grey	IP 40	2 C	A	PT 2.8	02-690.012	1	7	13	0.055
				PT 4.8	02-690.013	1	7	13	0.055
				ST	02-690.011	1	7	13	0.055
Position A : lockable, non-actuated or actuated Standard lock YB1 Front plastic grey	IP 40	2 C	A	PT 2.8	02-692.012	1	7	13	0.055
				PT 4.8	02-692.013	1	7	13	0.055
				ST	02-692.011	1	7	13	0.055
Position A : lockable, non-actuated Standard lock YB1 Front plastic grey	IP 40	2 C	A	PT 2.8	02-691.012	1	7	13	0.055
				PT 4.8	02-691.013	1	7	13	0.055
				ST	02-691.011	1	7	13	0.055
Position A : lockable, non-actuated or actuated Standard lock YB1 Front plastic grey (can be used with protective cover 22-925)	IP 40	2 C	A	PT 2.8	02-198.012	1	7	13	0.055
				PT 4.8	02-198.013	1	7	13	0.055
				ST	02-198.011	1	7	13	0.055
Position A : lockable, non-actuated Position C : locked, key not removeable Standard lock YB1 Front plastic grey	IP 40	2 C	A	PT 2.8	02-695.012	1	7	13	0.055
				PT 4.8	02-695.013	1	7	13	0.055
				ST	02-695.011	1	7	13	0.055

After turning the key 90° clockwise, the switch can be operated.
In the unlocked positions the switch always performs a momentary action.
Contacts: C = Changeover
Terminals: PT 2.8 = Plug-in terminal 2.8 mm, PT 4.8 = Plug-in terminal 4.8 mm, ST = Screw terminal
Mounting dimensions from page 22, Technical drawing from page 22, Circuit drawing from page 25

Mushroom-head keylock switch 2 positions

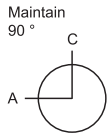

	Front protection	Contacts	Key remove	Terminals	□ 24 x 36 mm Typ-Nr.	Mounting dimensions	Technical drawing	Circuit drawing	
Mushroom-head keylock switch 2 positions Position A : lockable, actuated Standard lock YB1 Mushroom-head cap plastic grey	IP 40	2 C	A	PT 2.8	02-199.012	1	8	14	0.055
				PT 4.8	02-199.013	1	8	14	0.055
				ST	02-199.011	1	8	14	0.055

Lens can be operated without key, twist to key release.

Note: Switch gear is not usable for emergency-stop switch application!

Contacts: C = Changeover

Terminals: PT 2.8 = Plug-in terminal 2.8 mm, PT 4.8 = Plug-in terminal 4.8 mm, ST = Screw terminal

Mounting dimensions from page 22, Technical drawing from page 22, Circuit drawing from page 25

Front

Lens

	Lens	□ 24 x 36 mm Typ-Nr.	 kg
Lens 17.5 x 25.4 mm, illuminative (not recommended for film insert), ripped	Plastic blue translucent flush	02-901.6	0.004
	Plastic colourless transparent flush	02-901.7	0.004
	Plastic green translucent flush	02-901.5	0.004
	Plastic orange translucent flush	02-901.3	0.004
	Plastic red translucent flush	02-901.2	0.004
	Plastic smoked translucent flush	02-901.1	0.004
	Plastic white translucent flush	02-901.9	0.004
	Plastic yellow translucent flush	02-901.4	0.004
17.5 x 25.4 mm, illuminative (use Holder for film insert)	Plastic colourless transparent flush	02-902.7	0.004
	Plastic green translucent flush	02-902.5	0.004
	Plastic red translucent flush	02-902.2	0.004
17.5 x 25.4 mm, non-illuminative	Plastic black opaque flush	02-901.0	0.004
	Plastic grey opaque flush	02-901.8	0.004



Mushroom-head cap

use Front bezel flush

	Lens	Typ-Nr.	 kg
Mushroom-head cap 23 x 35 mm	Plastic black opaque	02-930.0	0.016
	Plastic green opaque	02-930.5	0.016
	Plastic red opaque	02-930.2	0.016
	Plastic yellow opaque	02-930.4	0.016



Keylock front bezel

	Typ-Nr.	 kg
Keylock front bezel grey	02-980.1	0.020
grey, for keylock switch 02-695	02-982.1	0.020



Standard lock YB1, other lock numbers on request

Holder

	Holder	Typ-Nr.	 kg
Holder for Lens with film insert	Plastic blue	02-908.6	0.001
	Plastic colourless	02-908.7	0.001
	Plastic green	02-908.5	0.001
	Plastic orange	02-908.3	0.001
	Plastic red	02-908.2	0.001
	Plastic white	02-908.9	0.001
	Plastic yellow	02-908.4	0.001





Diffusor plate

		Typ-Nr.	
Diffusor plate for Lens with film insert		02-909	0.001





Front bezel flush

	Front bezel	 24 x 36 mm Typ-Nr.	
Front bezel flush	Plastic black	02-965.0	0.001



Front bezel raised



Lens only removable with lens remover 98-969

	Front bezel	 24 x 36 mm Typ-Nr.	
Front bezel raised	Plastic black	02-967.0	0.001



Protective cover

use Front bezel flush

		 24 x 36 mm Typ-Nr.	Technical drawing	
Protective cover hinged, transparent, with means for sealing		22-925	5	0.004



Technical drawing from page 22

Sprayproof cover

use Front bezel flush

	Front protection	Typ-Nr.	Mounting dimensions Technical drawing	
Sprayproof cover three-part, PVC (-20 °C ... +60 °C)	IP 65	02-924	2 4	0.005
three-part, Silicone (-25 °C ... +85 °C)	IP 65	02-935	2 4	0.005



Mounting dimensions from page 22, Technical drawing from page 22

Blind plug

	Blind plug	□ 24 x 36 mm Typ-Nr.	Mounting dimensions	
Blind plug	Plastic black	02-949.0	1	0.004
	Plastic grey	02-949.8	1	0.004



Mounting dimensions from page 22

Spare key

	Typ-Nr.	
Spare key Standard lock YB1	02-989.001	0.001



Other lock numbers on request

Backside

Terminal cover

all connection methods

	Typ-Nr.	
Terminal cover unsuitable for indicators with built-in series resistor with lamp	02-929	0.005



Illumination

Filament lamp

	Socket	Operating voltage/-current	Typ-Nr.	
Filament lamp	T6.8	12 VAC/DC, 100 mA	10-1209.1329	0.001
		12 VAC/DC, 50 mA	10-1209.1279	0.001
		24 VAC/DC, 25 mA	10-1212.1199	0.001
		24 VAC/DC, 50 mA	10-1212.1279	0.001
		28 VAC/DC, 40 mA	10-1213.1249	0.001
		30 VAC/DC, 40 mA	10-1214.1249	0.001
		36 VAC/DC, 35 mA	10-1216.1229	0.001
		48 VAC/DC, 25 mA	10-1219.1199	0.001
		6 VAC/DC, 200 mA	10-1206.1369	0.001



Single-LED

Single-LED	Socket	Light colour	Operating voltage/-current	Typ-Nr.	
Single-LED	T6.8	blue	12 VAC/DC, 9/17 mA	10-2K09.1076	0.002
			24 VAC/DC, 9/17 mA	10-2K12.1076	0.002
			28 VAC/DC, 9/17 mA	10-2K13.1076	0.002
			48 VAC/DC, 4/8 mA	10-2K19.1056	0.002
			6 VDC, 17 mA	10-2K06.3156	0.002
		green	12 VAC/DC, 9/17 mA	10-2K09.1075	0.002
			24 VAC/DC, 9/17 mA	10-2K12.1075	0.002
			28 VAC/DC, 9/17 mA	10-2K13.1075	0.002
			48 VAC/DC, 4/8 mA	10-2K19.1055	0.002
			6 VDC, 17 mA	10-2K06.3155	0.002
		red	12 VAC/DC, 9/17 mA	10-2K09.1072	0.002
			24 VAC/DC, 9/17 mA	10-2K12.1072	0.002
			28 VAC/DC, 9/17 mA	10-2K13.1072	0.002
			48 VAC/DC, 4/8 mA	10-2K19.1052	0.002
			6 VDC, 17 mA	10-2K06.3152	0.002
		white diffuse	12 VAC/DC, 9/17 mA	10-2K09.1079	0.002
			24 VAC/DC, 9/17 mA	10-2K12.1079	0.002
			28 VAC/DC, 9/17 mA	10-2K13.1079	0.002
			48 VAC/DC, 4/8 mA	10-2K19.1059	0.002
			6 VDC, 17 mA	10-2K06.3159	0.002
		yellow	12 VAC/DC, 9/17 mA	10-2K09.1074	0.002
			24 VAC/DC, 9/17 mA	10-2K12.1074	0.002
			28 VAC/DC, 9/17 mA	10-2K13.1074	0.002
			48 VAC/DC, 4/8 mA	10-2K19.1054	0.002
6 VDC, 17 mA	10-2K06.3154		0.002		



Note:

AC operation through half-wave rectifier possible, slight flickering can occur.

Series resistor

for lamp voltage reduction

Series resistor	Operating voltage	Typ-Nr.	
10 kΩ, for filament lamp 48 VAC, 25 mA	230/240 V	02-904.7	0.003
2.7 kΩ, for filament lamp 48 VAC, 25 mA	110 V	02-904.0	0.003
3.3 kΩ, for filament lamp 48 VAC, 25 mA	125 V	02-904.1	0.003
4.7 kΩ, for filament lamp 48 VAC, 25 mA	145 V	02-904.3	0.003



Please keep to the country specific security rules.

Terminal plate empty

for fitting with series resistors

Terminal plate empty	Typ-Nr.	
10 spaces 125 x 60 x 15 mm	02-912.2	0.045
15 spaces 187.5 x 60 x 15 mm	02-912.3	0.090
20 spaces 250 x 60 x 15 mm	02-912.4	0.095
5 spaces 62.5 x 60 x 15 mm	02-912.1	0.025



Assembling

Lens remover

	Typ-Nr.	 kg
Lens remover for flush front bezel	02-905	0.011
for raised front bezel	98-968	0.004



Lamp remover

	Typ-Nr.	0.011
Lamp remover Filament lamp	61-9740.0	0.004
LED	03-996	



CAUTION

A switching process might be released when replacing the Lamp/LED !

Actuator with snap-action switching element

Switching system

- 1 or 2 self-cleaning, snap-action switching elements.
- 1 or 2 double-throw contacts.

Material

Material of contact

Standard version:
Silver (U >20 V)
Special versions: (on request)
Gold/Silver 700 Au/300 Ag (U <50 V)
Silver/Palladium 700 Ag/300 Pd (U >20 V) for atmospheres containing sulphur

Switch housing

Thermosetting material, heat-resistant

Indicator housing with reduced length

Polyamide

Mechanical characteristics

Terminals

Screw terminal (with self-lifting clip):
max. wire cross-section, 2 x 2.5 mm²
max. wire cross-section of stranded cable, 2 x 1.5 mm²

Plug-in terminal 2.8 x 0.8 mm:
max. wire cross-section of stranded cable, 1 mm² can also be used as soldering terminal
max. wire cross-section, 2 x 1 mm²
max. wire cross-section of stranded cable: 2 x 0.75 mm²

Plug-in terminal 4.8 x 0.8 mm:
max. wire cross-section of stranded cable, 2.5 mm² can also be used as soldering terminal
max. wire cross-section: 2 x 1 mm²
max. wire cross-section of stranded cable, 2 x 0.75 mm²

Actuating force

6 N ... 12 N

Actuating travel

5 mm

Mechanical lifetime

Momentary action 2 million operations
Maintained action 1 million operations

Electrical characteristics

Standards

The switches comply with the "Standards for low-voltage switching devices" EN IEC 61058-1

Rated insulation voltage

400 VAC/440 VDC, as per IEC 61058-1

Conventional free air thermal current

10 A
The maximum current in continuous operation and at ambient temperature not exceeding the quoted maximum values.

Switch rating

400 VAC, 10 A, cosφ 0.95, as per IEC 61058-1
250 VAC, 10 A, as per UL

Electric strength

2500 VAC, 50 Hz, 1 min. between all terminals and earth, as per IEC 61058-1

Environmental conditions

Storage temperature

-30 °C ... +85 °C

Service temperature

-25 °C ... +55 °C

For indicators and illuminated pushbuttons mounted as a block, make sure the heat can escape freely.

Protection degree

Front side IP 40, IP 65 with spray cover, as per IEC 60529

Shock resistance

15 g for 11 ms, as per IEC 60068-2-27

Vibration resistance

10 g at 10-2000 Hz, amplitude 1.0 mm, as per IEC 60068-2-6

Approvals

Approbations

CB (IEC 61058-1/92)
CSA
ENEC (EN 61058-1/92)
Germanischer Lloyd
UL
VDE

Declaration of conformity

CE

Buzzer

Buzzer system

System

Electronic non-contacting buzzer with IC oscillator

Material

Alarm buzzer case

Thermosetting material

Front cap

Polycarbonate (PC)

Front bezel

Polymethylacrylate

Mechanical characteristics

Terminals

Screw terminal

Electrical characteristics

Frequency (tone)

Approx. 2.8 kHz

Sound pressure

85 dB (A) ±8 dB at a distance of 0.1 m
Volume variable with a 1 MΩ potentiometer or corresponding fixed resistor

Operation Voltage/Current

typical

10 ... 55 VAC 10 ... 75 VDC
25 mA 15 mA

Environmental conditions**Storage temperature**

-40 °C ... +85 °C

Operating temperature

-25 °C ... +55 °C

Protection degree

Front side IP 40, as per IEC 60529

Approvals**Approbations**

CB (IEC 61058-1/92)
ENEC (EN 61058-1/92)

Declaration of conformity

CE

Buzzer

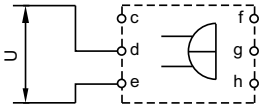

1. Supply voltage I
 Continous tone
 U = 10 - 35 VAC
 U = 10 - 50 VDC

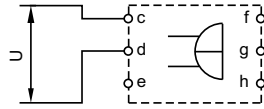

2. Supply voltage II
 Continous tone
 U = 35 - 55 VAC
 U = 35 - 75 VDC

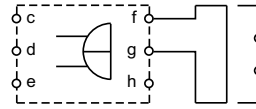

3. Intermittent tone
 Interval approx. 3 Hz

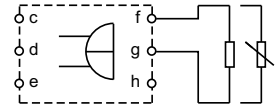

4. Volume control

Suppressor circuits

When switching inductive loads such as relays, DC motors, and DC solenoids, it is always important to absorb surges (e.g. with a diode) to protect the contacts. When these inductive loads are switched off, a counter emf can severely damage switch contacts and greatly shorten lifetime.

Fig. 1 shows an inductive load with a free-wheeling diode connected in parallel. This free-wheeling diode provides a path for the inductor current to flow when the current is interrupted by the switch. Without this free-wheeling diode, the voltage across the coil will be limited only by dielectric breakdown voltages of the circuit or parasitic elements of the coil. This voltage can be kilovolts in amplitude even when nominal circuit voltages are low (e.g. 12 VDC) see Fig. 2.

The free-wheeling diode should be chosen so that the reverse breakdown voltage is greater than the voltage driving the inductive load. The DC blocking voltage (VR) of the free-wheeling diode can be found in the datasheet of a diode. The forward current should be equal or greater than the maximum current flowing through the load.

To get an efficient protection, the free-wheeling diode must be connected as close as possible to the inductive load!

Switching with inductive load
Fig. 1

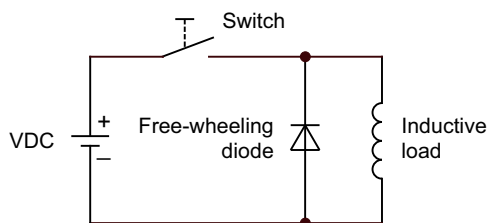

Counter emf
over load without free-wheeling diode
Fig. 2

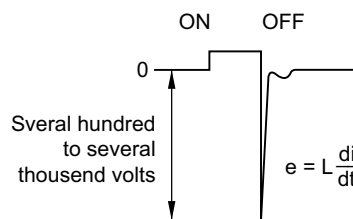

General notes

1. Engraving

In addition to the most commonly used world languages, in DIN 1451-3 close spacing, other typefaces are available as Scandinavian, Slavic, Greek, Russian and Polish.

Red, blue and black lenses are filled with white colour. Other colour lenses are filled in black. Standard height of letters is 3 mm. If the height is not specified, we will supply 3 mm engraved letters.

2. Hot stamping

For larger series it is worth considering markings by means of hot stamping. We will be pleased to advise you.

For letters and figures, typefaces with 2.5 mm, 3 mm and 4 mm are available.

3. Film inserts

Instead of using engraving the lenses can be fitted with transparent film inserts, as an alternative. For this purpose, though, it is advisable to use lenses without ripped pattern. In the case of use of a smoke-black lens the fitted film becomes readable only if the lamp is on.

The film (F) is inserted in the cap. To ensure even illumination a diffuser (D) is recommended, which is inserted beneath the film. If, on the other hand, the diffuser is inserted above the film, the lettering only becomes legible when the lamp is alight. To hold the film and diffuser in position, the use of a holder (N) is advised.

The film thickness is 0.2 mm.

All dimensions in mm

Film insert max. size	Height of letters h	Number of lines	Number of (target value) capital letters per line	Number of (target value) small letters per line	Image
14.3 x 22.4	3	4	11	13	B1
			7 - 8	8 - 9	B2
	4	2	7	9	B1
			4	5	5 - 6
	5	2	5 - 6	6 - 7	B1
			3	3 - 4	4
	6	1	5	6	B1
			2	3	4
	8	1	3	4	B1
			2	2	B2

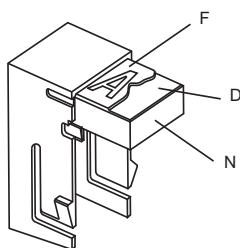
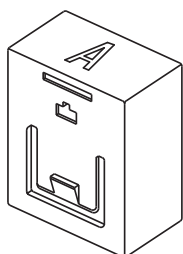

B1

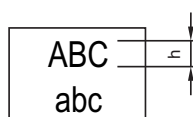

B2

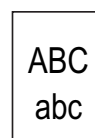

Mounting dimensions

1 Indicator actuator page 5 | Buzzer page 6 | Pushbutton actuator page 7 | Illuminated pushbutton actuator page 8 | Mushroom-head pushbutton actuator page 9 | Keylock switch actuator 2 positions page 10 | Mushroom-head keylock switch 2 positions page 11 | Blind plug page 14

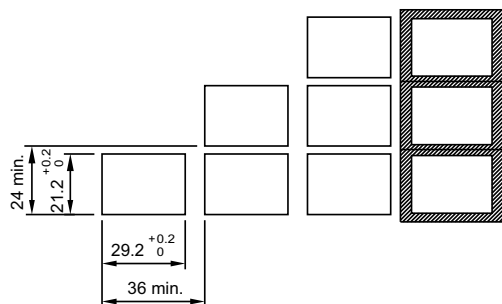

2 Sprayproof cover page 13

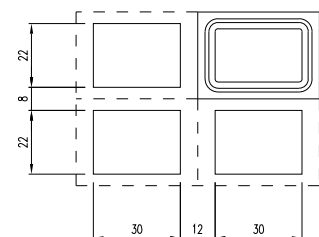

Technical drawing

1 Indicator actuator page 5

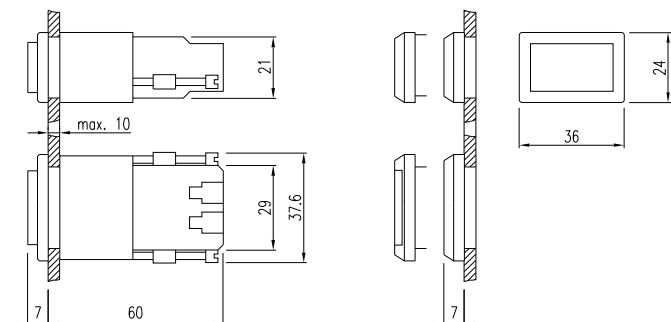

2 Indicator actuator page 5

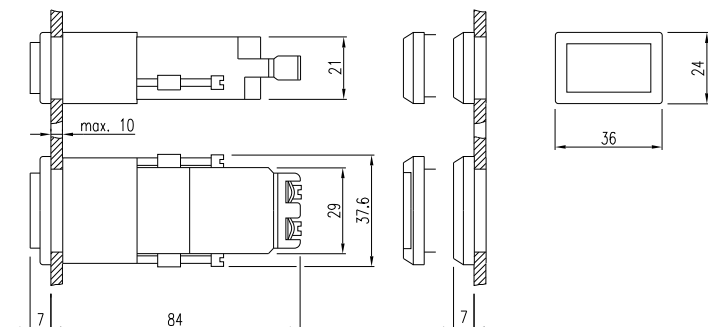

3 Buzzer page 6

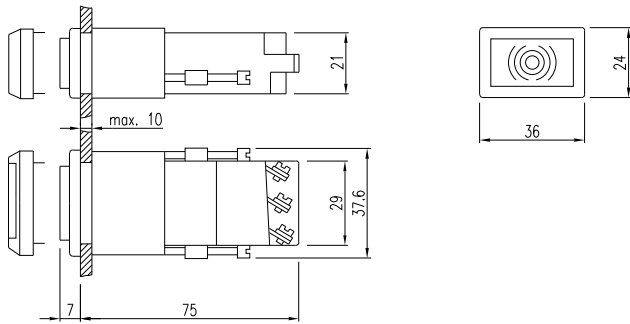

4 Sprayproof cover page 13

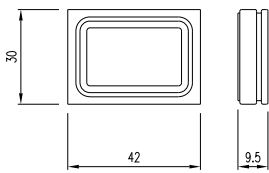

5 Protective cover page 13

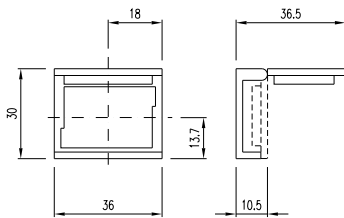

6 Pushbutton actuator page 7 | Illuminated pushbutton actuator page 8

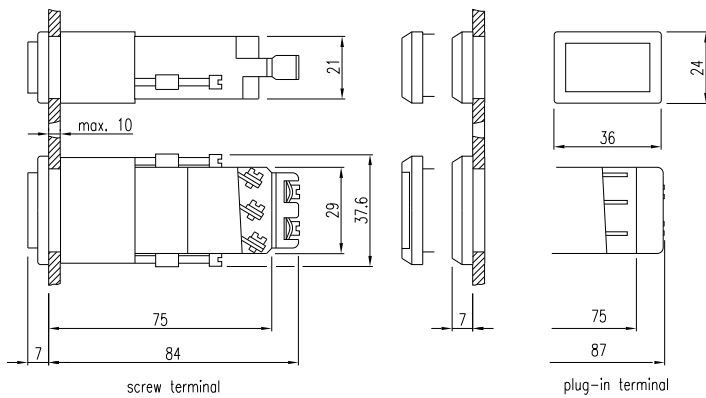

7 Keylock switch actuator 2 positions page 10

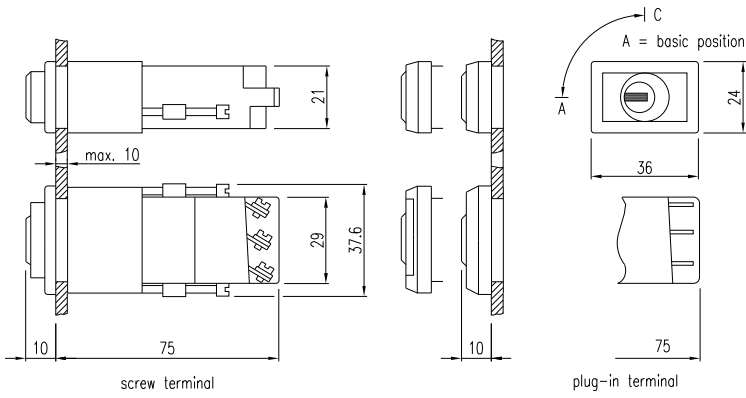

8 Mushroom-head keylock switch 2 positions page 11

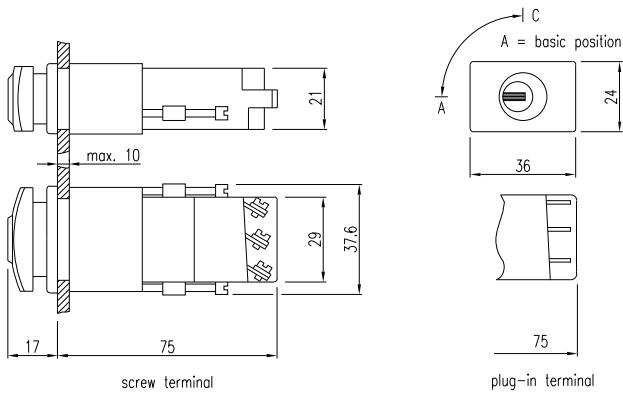

9 Mushroom-head pushbutton actuator page 9

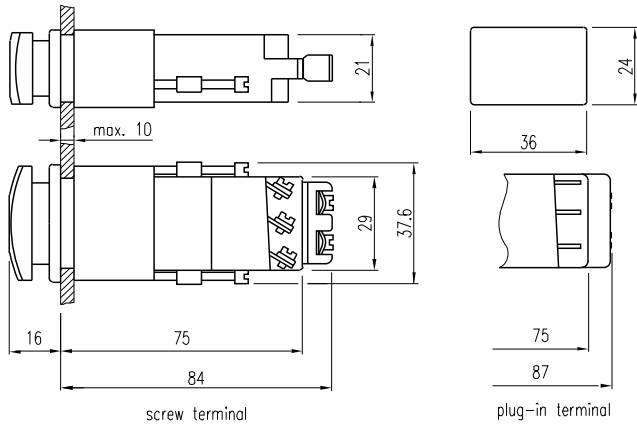

Circuit drawing

1 Buzzer page 6

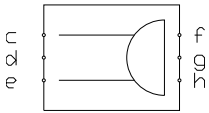

2 Indicator actuator page 5



3 Illuminated pushbutton actuator page 8

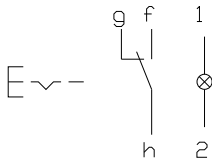

4 Pushbutton actuator page 7 | Mushroom-head pushbutton actuator page 9

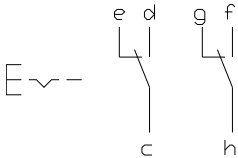

5 Illuminated pushbutton actuator page 8

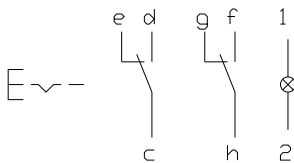

6 Pushbutton actuator page 7 | Mushroom-head pushbutton actuator page 9

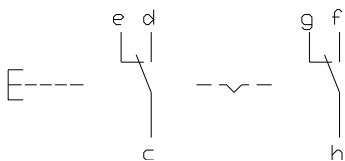

7 Pushbutton actuator page 7 | Mushroom-head pushbutton actuator page 9

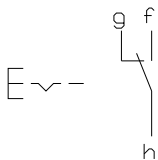

8 Pushbutton actuator page 7 | Mushroom-head pushbutton actuator page 9

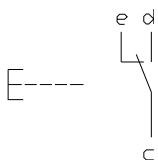

9 Pushbutton actuator page 7 | **Mushroom-head pushbutton actuator** page 9

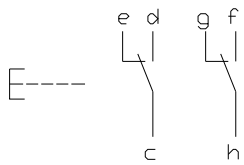

10 Illuminated pushbutton actuator page 8

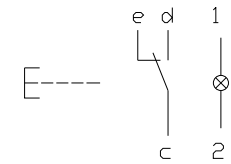

11 Illuminated pushbutton actuator page 8

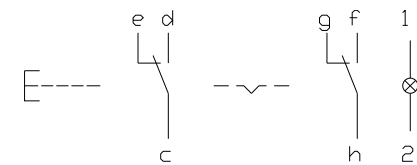

12 Illuminated pushbutton actuator page 8

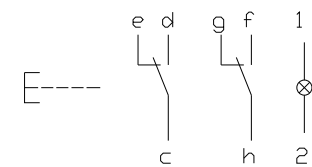

13 Keylock switch actuator 2 positions page 10

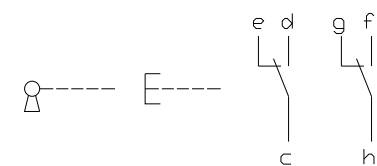

14 Mushroom-head keylock switch 2 positions page 11

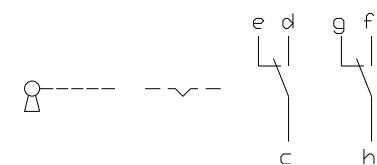

Index from Typ-Nr.

Typ-Nr.	Page	Typ-Nr.	Page	Typ-Nr.	Page
02-021.001	5	02-620.013	8	10-1212.1279	14
02-021.002	5	02-690.011	10	10-1213.1249	14
02-021.003	5	02-690.012	10	10-1214.1249	14
02-070.001	5	02-690.013	10	10-1216.1229	14
02-070.002	5	02-691.011	10	10-1219.1199	14
02-070.003	5	02-691.012	10	10-2K06.3152	15
02-071.001	5	02-691.013	10	10-2K06.3154	15
02-071.002	5	02-692.011	10	10-2K06.3155	15
02-071.003	5	02-692.012	10	10-2K06.3156	15
02-072.001	5	02-692.013	10	10-2K06.3159	15
02-072.002	5	02-695.011	10	10-2K09.1072	15
02-072.003	5	02-695.012	10	10-2K09.1074	15
02-073.001	5	02-695.013	10	10-2K09.1075	15
02-073.002	5	02-810.001	6	10-2K09.1076	15
02-073.003	5	02-901.0	12	10-2K09.1079	15
02-198.011	10	02-901.1	12	10-2K12.1072	15
02-198.012	10	02-901.2	12	10-2K12.1074	15
02-198.013	10	02-901.3	12	10-2K12.1075	15
02-199.011	11	02-901.4	12	10-2K12.1076	15
02-199.012	11	02-901.5	12	10-2K12.1079	15
02-199.013	11	02-901.6	12	10-2K13.1072	15
02-611.011	7	02-901.7	12	10-2K13.1074	15
02-611.011	9	02-901.8	12	10-2K13.1075	15
02-611.012	7	02-901.9	12	10-2K13.1076	15
02-611.012	9	02-902.2	12	10-2K13.1079	15
02-611.013	7	02-902.5	12	10-2K19.1052	15
02-611.013	9	02-902.7	12	10-2K19.1054	15
02-612.011	7	02-904.0	15	10-2K19.1055	15
02-612.011	9	02-904.1	15	10-2K19.1056	15
02-612.013	7	02-904.3	15	10-2K19.1059	15
02-612.013	9	02-904.7	15	22-925	13
02-613.011	7	02-905	16	61-9740.0	16
02-613.011	9	02-908.2	12	98-968	16
02-613.012	7	02-908.3	12		
02-613.012	9	02-908.4	12		
02-613.013	7	02-908.5	12		
02-613.013	9	02-908.6	12		
02-614.011	7	02-908.7	12		
02-614.011	9	02-908.9	12		
02-614.012	7	02-909	13		
02-614.012	9	02-912.1	15		
02-614.013	7	02-912.2	15		
02-614.013	9	02-912.3	15		
02-615.011	7	02-912.4	15		
02-615.011	9	02-924	13		
02-615.012	7	02-929	14		
02-615.012	9	02-930.0	12		
02-615.013	7	02-930.2	12		
02-615.013	9	02-930.4	12		
02-616.011	8	02-930.5	12		
02-616.012	8	02-935	13		
02-616.013	8	02-949.0	14		
02-617.011	8	02-949.8	14		
02-617.012	8	02-965.0	13		
02-617.013	8	02-967.0	13		
02-618.011	8	02-980.1	12		
02-618.012	8	02-982.1	12		
02-618.013	8	02-989.001	14		
02-619.011	8	03-996	16		
02-619.012	8	10-1206.1369	14		
02-619.013	8	10-1209.1279	14		
02-620.011	8	10-1209.1329	14		
02-620.012	8	10-1212.1199	14		

	EAO AG
	Tannwaldstrasse 88 4601 Olten, Switzerland
E-mail	info@eao.com
Website	www.eao.com
	Austria
Phone	+49 201 85 87 0
Fax	+49 201 85 87 210
E-mail	sales.ede@eao.com
	Belgium
Phone	+32 3 777 82 36
Fax	+32 3 777 84 19
E-mail	sales.ebl@eao.com
	China
Phone	+852 27 86 91 41
Fax	+852 27 86 95 61
E-mail	sales.ehk@eao.com
	France
Phone	+33 1 64 43 37 37
Fax	+33 1 64 43 37 49
E-mail	sales.esa@eao.com
	Germany
Phone	+49 201 85 87 0
Fax	+49 201 85 87 210
E-mail	sales.ede@eao.com
	Italy
Phone	+39 035 481 0189
Fax	+39 035 481 3786
E-mail	sales.eit@eao.com
	Japan
Phone	+81 3 5444 5411
Fax	+81 3 5444 0345
E-mail	sales.esj@eao.com
	Netherlands
Phone	+31 78 653 17 00
Fax	+31 78 653 17 99
E-mail	sales.enl@eao.com
	Sweden
Phone	+46 8 683 86 60
Fax	+46 8 724 29 12
E-mail	sales.esw@eao.com
	Switzerland
Phone	+41 62 388 95 00
Fax	+41 62 388 95 55
E-mail	sales.ech@eao.com
	United Kingdom
Phone	+44 1444 236 000
Fax	+44 1444 236 641
E-mail	sales.euk@eao.com
	USA
Phone	+1 203 877 4577
Fax	+1 203 877 3694
E-mail	sales.eus@eao.com
	Other Countries
Phone	+41 62 286 92 10
Fax	+41 62 296 21 62
E-mail	info@eao.com

Данный компонент на территории Российской Федерации

Вы можете приобрести в компании MosChip.

Для оперативного оформления запроса Вам необходимо перейти по данной ссылке:

<http://moschip.ru/get-element>

Вы можете разместить у нас заказ для любого Вашего проекта, будь то серийное производство или разработка единичного прибора.

В нашем ассортименте представлены ведущие мировые производители активных и пассивных электронных компонентов.

Нашей специализацией является поставка электронной компонентной базы двойного назначения, продукции таких производителей как XILINX, Intel (ex.ALTERA), Vicor, Microchip, Texas Instruments, Analog Devices, Mini-Circuits, Amphenol, Glenair.

Сотрудничество с глобальными дистрибьюторами электронных компонентов, предоставляет возможность заказывать и получать с международных складов практически любой перечень компонентов в оптимальные для Вас сроки.

На всех этапах разработки и производства наши партнеры могут получить квалифицированную поддержку опытных инженеров.

Система менеджмента качества компании отвечает требованиям в соответствии с ГОСТ Р ИСО 9001, ГОСТ РВ 0015-002 и ЭС РД 009

Офис по работе с юридическими лицами:

105318, г.Москва, ул.Щербаковская д.3, офис 1107, 1118, ДЦ «Щербаковский»

Телефон: +7 495 668-12-70 (многоканальный)

Факс: +7 495 668-12-70 (доб.304)

E-mail: info@moschip.ru

Skype отдела продаж:

moschip.ru

moschip.ru_4

moschip.ru_6

moschip.ru_9