

Analog Devices Welcomes Hittite Microwave Corporation

NO CONTENT ON THE ATTACHED DOCUMENT HAS CHANGED



THIS PAGE INTENTIONALLY LEFT BLANK

1dB LSB GaAs MMIC 3-BIT DIGITAL POSITIVE CONTROL ATTENUATOR, DC - 6GHz

Typical Applications

The HMC468ALP3E is ideal for:

- Cellular; UMTS/3G Infrastructure
- Fixed Wireless & WLL
- Microwave Radio & VSAT
- Test Equipment

Features

- 1 dB LSB Steps to 7 dB
- High IP3: +55 dBm
- ± 0.25 dB Typical Bit Error
- Single Control Line Per Bit
- Single +5V Supply
- 16 Lead 3x3 mm SMT Package: 9 mm²

Functional Diagram

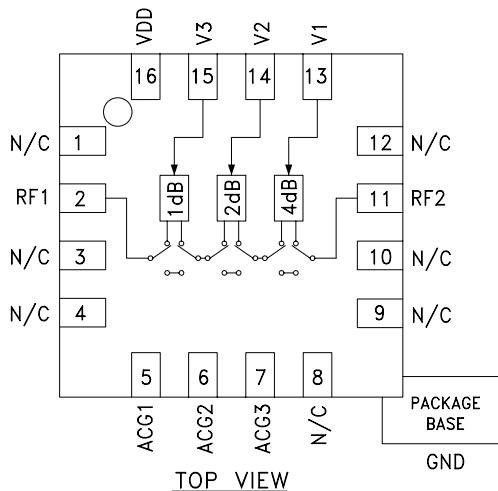

General Description

The HMC468ALP3E is a broadband 3-bit GaAs IC digital attenuators in a low cost leadless surface mount package. Covering DC to 6.0 GHz, the insertion loss is less than 1 dB typical up to 4 GHz. The attenuator bit values are 1 (LSB), 2 and 4 dB for a total attenuation of 7 dB. Attenuation accuracy is excellent at ±0.4 dB typical step error with an IIP3 of +55 dBm. Three control voltage inputs, toggled between 0 and +5V, are used to select each attenuation state. A single Vdd bias of +5V is required.

Electrical Specifications, $T_A = +25^\circ C$, With $V_{dd} = +5V$ & $V_{ctl} = 0/+5V$

Parameter	Frequency (GHz)	Min.	Typ.	Max.	Units
Insertion Loss	DC - 2.5 GHz		0.5	1.0	dB
	2.5 - 4.5 GHz		0.7	1.2	dB
	4.5 - 6.0 GHz		0.9	1.4	dB
Attenuation Range	DC - 6 GHz		7		dB
Return Loss (RF1 & RF2, All Atten. States)	DC - 6 GHz		20		dB
Attenuation Accuracy: (Referenced to Insertion Loss)	All States	DC - 2.5 GHz	± 0.2 + 2% of Atten. Setting Max.		dB
	1 - 4 dB States	2.5 - 6.0 GHz	± 0.3 + 3% of Atten. Setting Max.		dB
	5 - 7 dB States	2.5 - 6.0 GHz	± 0.4 + 4% of Atten. Setting Max.		dB
Input Power for 0.1 dB Compression	0.25 - 6.0 GHz		26		dBm
Input Third Order Intercept Point (Two-Tone Input Power= 0 dBm Each Tone)	0.25 - 6.0 GHz		55		dBm
Switching Characteristics	DC - 6 GHz				
tRISE, tFALL (10/90% RF)			60		ns
tON, tOFF (50% CTL to 10/90% RF)			80		ns

* Bypass capacitor connecting ACG1, ACG2 & ACG3 to RF ground required per pin description herein.

For price, delivery and to place orders: Hittite Microwave Corporation, 2 Elizabeth Drive, Chelmsford, MA 01824

Phone: 978-250-3343 Fax: 978-250-3373 Order On-line at www.hittite.com

Application Support: Phone: 978-250-3343 or apps@hittite.com



1dB LSB GaAs MMIC 3-BIT DIGITAL POSITIVE CONTROL ATTENUATOR, DC - 6GHz

Insertion Loss

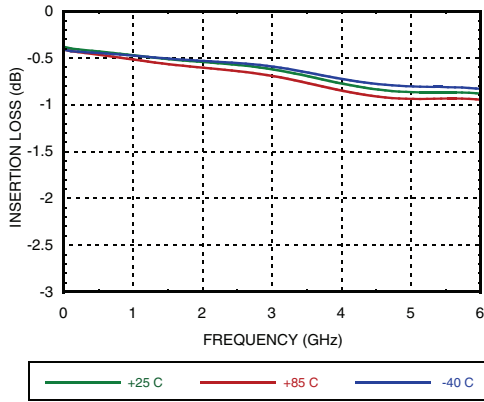

Return Loss RF1, RF2 (Only Major States are Shown)

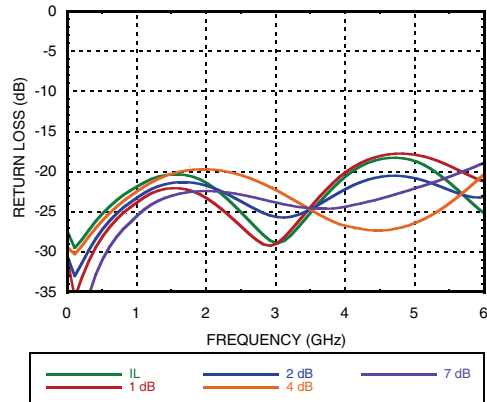

Normalized Attenuation (Only Major States are Shown)

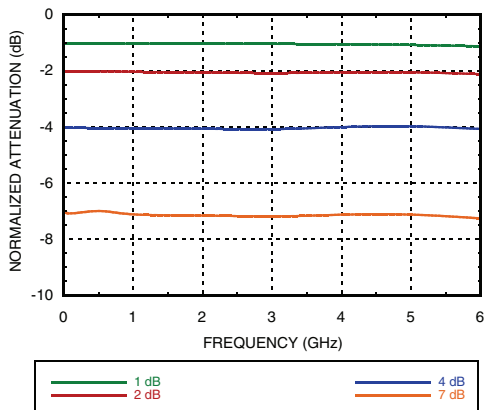

Bit Error vs. Attenuation State

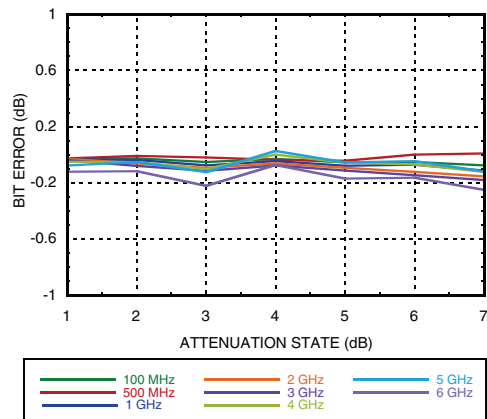

Bit Error vs. Frequency (Only Major States are Shown)

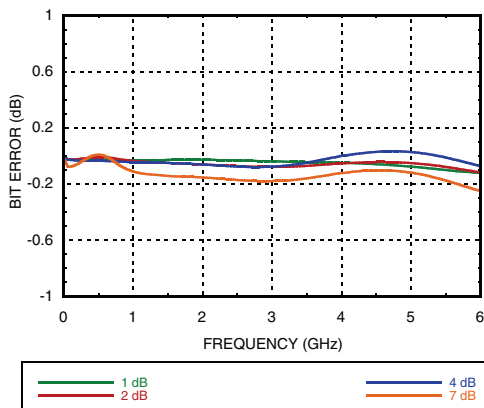

Relative Phase vs. Frequency (Only Major States are Shown)

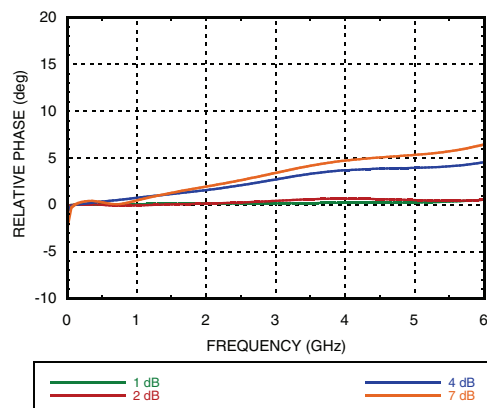



1dB LSB GaAs MMIC 3-BIT DIGITAL POSITIVE CONTROL ATTENUATOR, DC - 6GHz

Step Error Between Successive Attenuation States

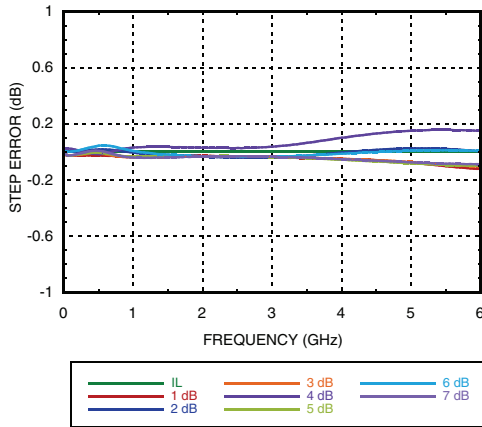

Truth Table

Control Voltage Input			Attenuation Setting RF1 - RF2
V1 4 dB	V2 2 dB	V3 1 dB	
High	High	High	Reference I.L.
High	High	Low	1 dB
High	Low	High	2 dB
Low	High	High	4 dB
Low	Low	Low	7 dB

Any combination of the above states will provide an attenuation approximately equal to the sum of the bits selected.

Bias Voltage & Current

Vdd Range= +5.0 Vdc ± 10%		
Vdd (Vdc)	Idd (Typ.) (mA)	Idd (Max.) (mA)
+5.0	1.05	1.8

TTL/CMOS Control Voltages

State	Bias Condition
Low	0 to 0.8 Vdc @ -0.05 uA Typ.
High	+2.0 to +5.0 Vdc @ 40 uA Typ.

**1dB LSB GaAs MMIC 3-BIT DIGITAL
POSITIVE CONTROL ATTENUATOR, DC - 6GHz**
Absolute Maximum Ratings

RF Input Power	+30 dBm
Control Voltage (V1 to V3)	-0.5 Vdc to Vdd +1 Vdc
Bias Voltage (Vdd)	+7 Vdc
Channel Temperature	150 °C
Continuous Pdiss (T = 85 °C) (derate 10. 1mW/ °C above 85 °C)	0.657 W
Thermal Resistance	99 °C/W
Storage Temperature	-65 to +150 °C
Operating Temperature	-40 to +85 °C
ESD Sensitivity (HBM)	Class 1A

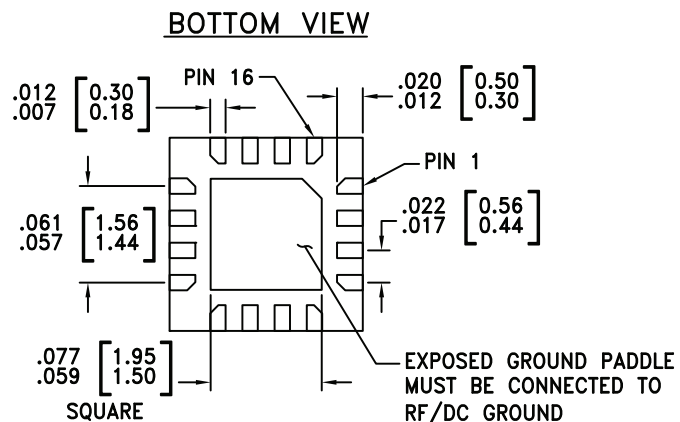
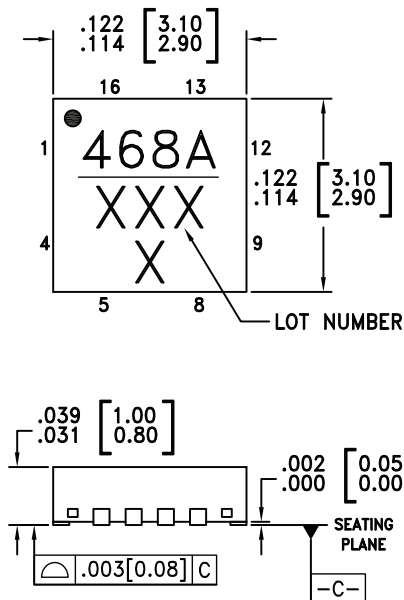
**ELECTROSTATIC SENSITIVE DEVICE
OBSERVE HANDLING PRECAUTIONS**
Outline Drawing

NOTES:

- LEADFRAME MATERIAL: COPPER ALLOY
- DIMENSIONS ARE IN INCHES [MILLIMETERS]
- LEAD SPACING TOLERANCE IS NON-CUMULATIVE
- PAD BURR LENGTH SHALL BE 0.15mm MAXIMUM.
PAD BURR HEIGHT SHALL BE 0.05mm MAXIMUM.
- PACKAGE WARP SHALL NOT EXCEED 0.05mm.
- ALL GROUND LEADS AND GROUND PADDLE MUST BE SOLDERED TO PCB RF GROUND.
- REFER TO HITTITE APPLICATION NOTE FOR SUGGESTED LAND PATTERN.

Package Information

Part Number	Package Body Material	Lead Finish	MSL Rating	Package Marking ^[1]
HMC468ALP3E	RoHS-compliant Low Stress Injection Molded Plastic	100% matte Sn	MSL1 ^[2]	468A XXXX



[1] 4-Digit lot number XXXX

[2] Max peak reflow temperature of 260 °C

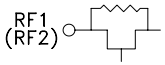
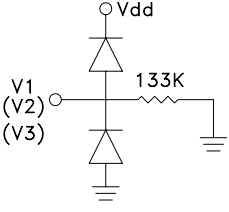

1dB LSB GaAs MMIC 3-BIT DIGITAL POSITIVE CONTROL ATTENUATOR, DC - 6GHz

Pin Descriptions

Pin Number	Function	Description	Interface Schematic
1, 3, 4, 8, 9, 10, 12	N/C	These pins should be connected to PCB RF ground to maximize performance.	
2, 11	RF1, RF2	This pin is DC coupled and matched to 50 Ohm. Blocking capacitors are required	
13 - 15	V1 - V3	See truth table and control voltage table.	
5 - 7	ACG1 - ACG3	External capacitor to ground is required. Select value for lowest frequency of operation. Place capacitor as close to pins as possible.	
16	Vdd	Supply Voltage	
	GND	Package bottom has an exposed metal paddle that must be connected to RF/DC ground.	

Application Circuit

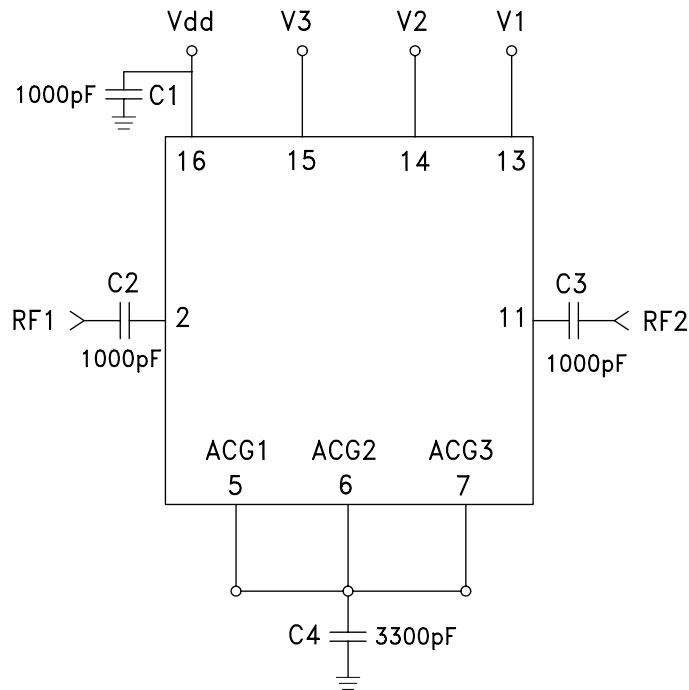



1dB LSB GaAs MMIC 3-BIT DIGITAL POSITIVE CONTROL ATTENUATOR, DC - 6GHz

Evaluation PCB

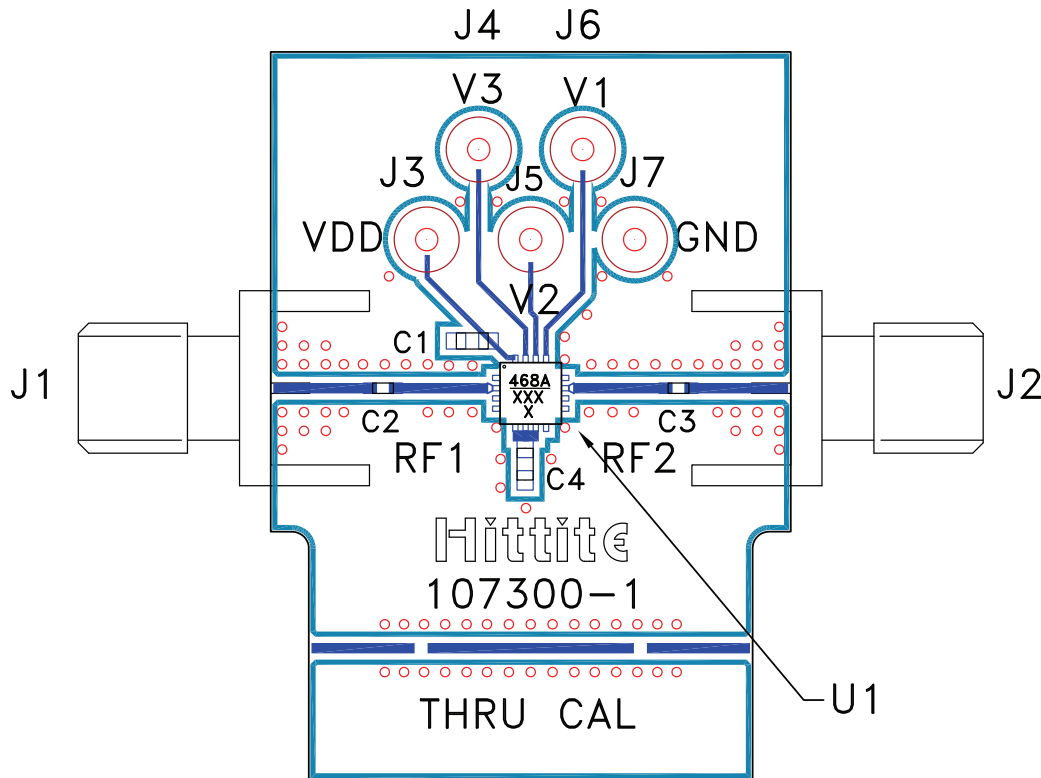

List of Materials for Evaluation PCB 107302 - HMC468ALP3 [1]

Item	Description
J1 - J2	PCB Mount SMA Connector
J3 - J7	DC Pin
C1	1000 pF Capacitor, 0603 Pkg.
C2, C3	100 pF Capacitor, 0402 Pkg.
C4	3300 pF Capacitor, 0603 Pkg.
U1	HMC468ALP3E Digital Attenuator
PCB [2]	107300 Evaluation PCB

[1] Reference this number when ordering complete evaluation PCB

[2] Circuit Board Material: Rogers 4350

The circuit board used in the application should use RF circuit design techniques. Signal lines should have 50 Ohm impedance while the package ground leads and exposed paddle should be connected directly to the ground plane similar to that shown. A sufficient number of via holes should be used to connect the top and bottom ground planes. The evaluation circuit board shown is available from Hittite upon request.

Данный компонент на территории Российской Федерации

Вы можете приобрести в компании MosChip.

Для оперативного оформления запроса Вам необходимо перейти по данной ссылке:

<http://moschip.ru/get-element>

Вы можете разместить у нас заказ для любого Вашего проекта, будь то серийное производство или разработка единичного прибора.

В нашем ассортименте представлены ведущие мировые производители активных и пассивных электронных компонентов.

Нашей специализацией является поставка электронной компонентной базы двойного назначения, продукции таких производителей как XILINX, Intel (ex.ALTERA), Vicor, Microchip, Texas Instruments, Analog Devices, Mini-Circuits, Amphenol, Glenair.

Сотрудничество с глобальными дистрибьюторами электронных компонентов, предоставляет возможность заказывать и получать с международных складов практически любой перечень компонентов в оптимальные для Вас сроки.

На всех этапах разработки и производства наши партнеры могут получить квалифицированную поддержку опытных инженеров.

Система менеджмента качества компании отвечает требованиям в соответствии с ГОСТ Р ИСО 9001, ГОСТ РВ 0015-002 и ЭС РД 009

Офис по работе с юридическими лицами:

105318, г.Москва, ул.Щербаковская д.3, офис 1107, 1118, ДЦ «Щербаковский»

Телефон: +7 495 668-12-70 (многоканальный)

Факс: +7 495 668-12-70 (доб.304)

E-mail: info@moschip.ru

Skype отдела продаж:

moschip.ru

moschip.ru_4

moschip.ru_6

moschip.ru_9