

# Sinica GNSS Antenna

Part No. SR4G008

lamiiANT<sup>®</sup>

Product Specification

## 1. Features

- Antenna for 1559 – 1609 MHz, GNSS for embedded applications
- Solution for all global public constellations: GPS, GLONASS, Beidou and GALILEO.
- Maintains high performance on device: DFI (Designed For Integration)
- Ultra flat compact design of only 0.4mm thickness.
- Designed for SMD mounting
- Supplied on Tape and Reel

## 2. Description

Sinica is intended for use with all positioning applications. The antenna has RHCP characteristics suitable for GNSS signals. A truly novel antenna approach with ultra-low profile, but with the high performance of a ceramic patch.

## 3. Applications

- Trackers
- Portable Devices
- Drones
- Network Devices
- Wearable devices



## 4. Part Number

**Sinica: SR4G008**

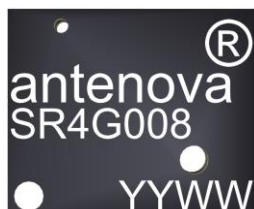

## 5. General Data

Product name	Sinica
Part Number	SR4G008
Frequency	1559 – 1609 MHz
Polarization	Linear
Operating temperature	-40°C to 125°C
Impedance with matching	50 Ω
Weight	< 0.2 g
Antenna type	SMD
Dimensions	7.0 x 5.8 x 0.4 (mm)

## 6. RF Characteristics

	Typical performance	Conditions
Peak gain	3.0dBi	<b>1559 - 1609 MHz frequency range</b> All data measured on Antenna's evaluation PCB Part No. SR4G008-U1
Average gain (Linear)	0dBi	
Average efficiency (Linear)	>75%	
Average efficiency (RHCP)	>38%	
Maximum return loss	-12dB	
Maximum VSWR	1.4:1	

## 7. RF Performance

### 7.1 Return Loss

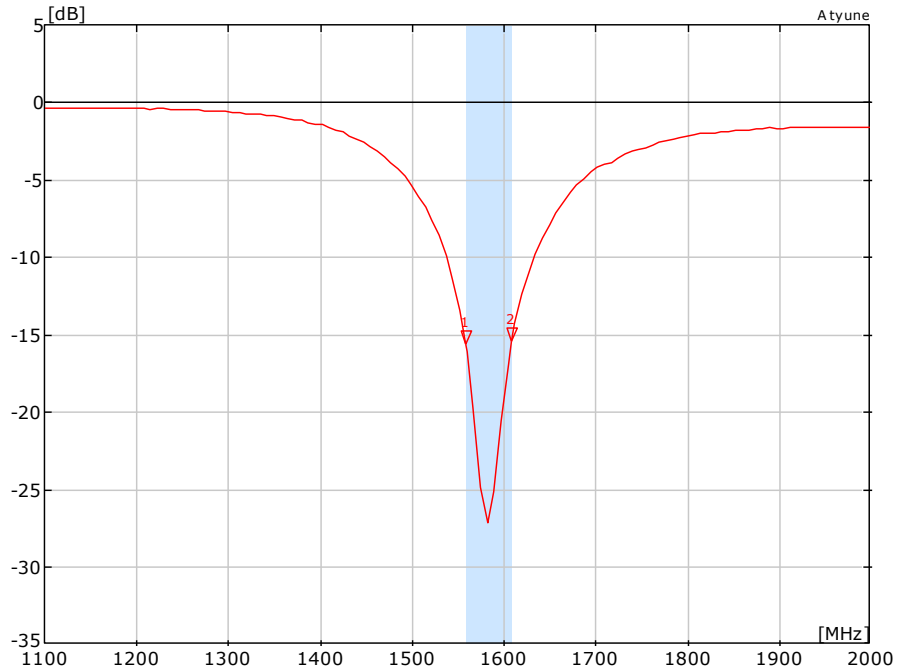

### 7.2 VSWR

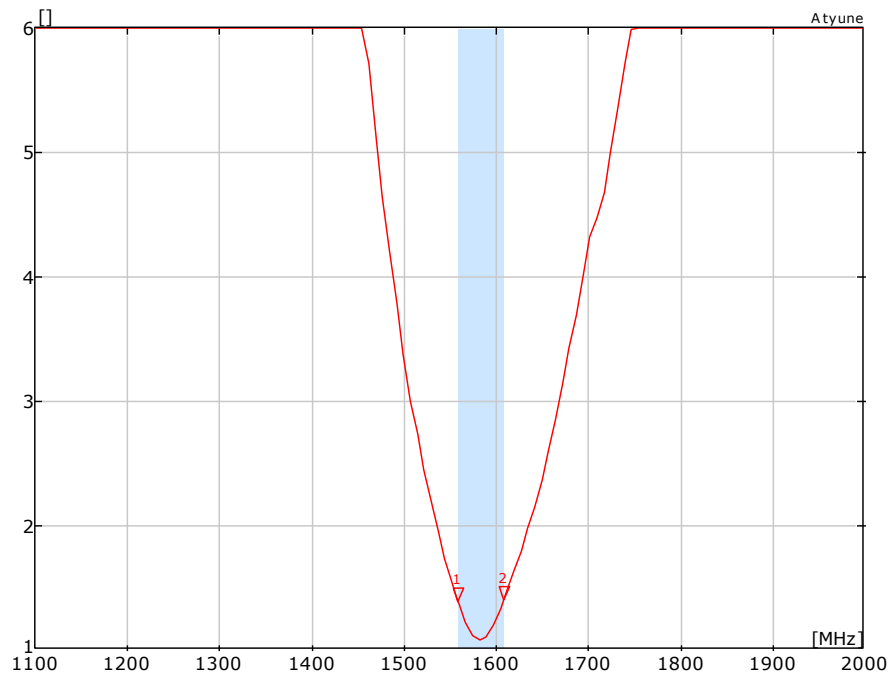

## 7.3 Antenna pattern

### 7.3.1 1559 MHz – 1609 MHz

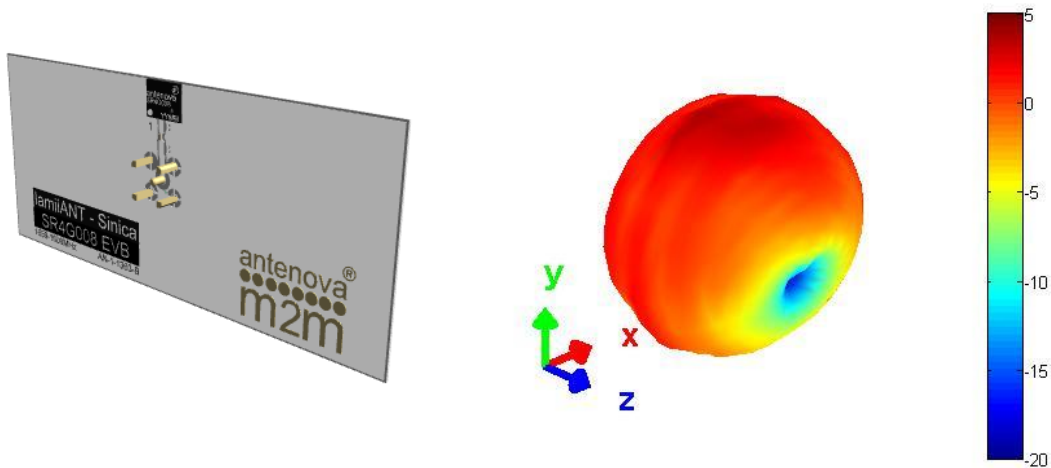

#### 3D pattern at 1575 MHz

Drag to rotate pattern and PCB by using Adobe Reader

XY

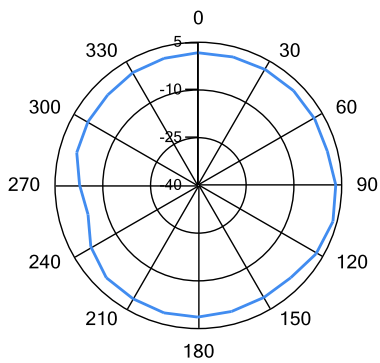

XZ

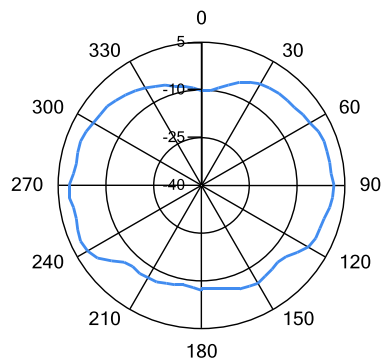

YZ

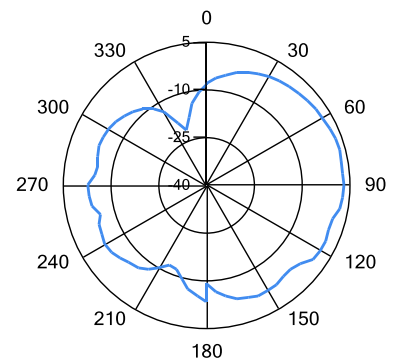

— 1.575GHz

## 8. Antenna Dimensions

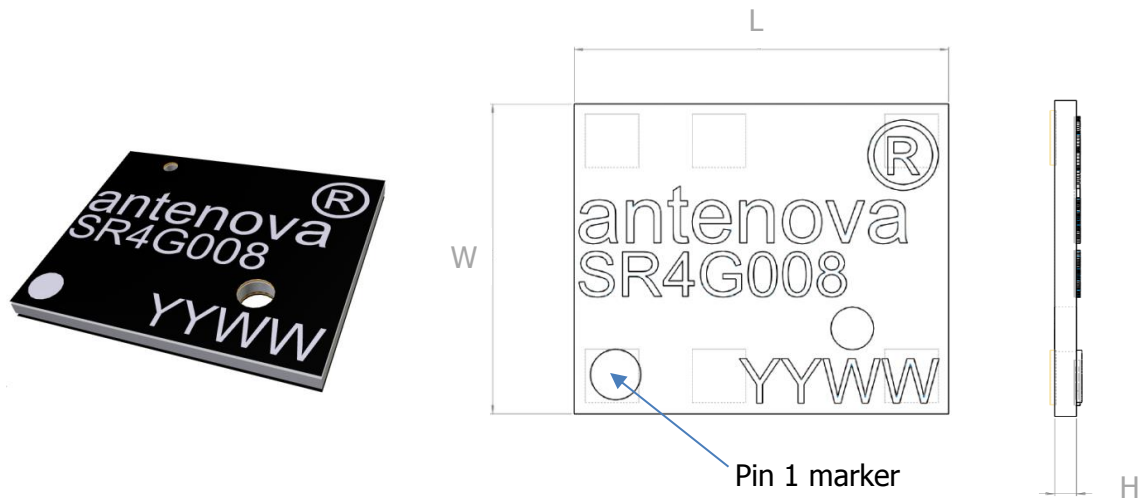

L	W	H
Length	Width	Height
7.0 ±0.1	5.8 ±0.1	0.4 ±0.2

All dimensions in mm

### Bottom side dimensions

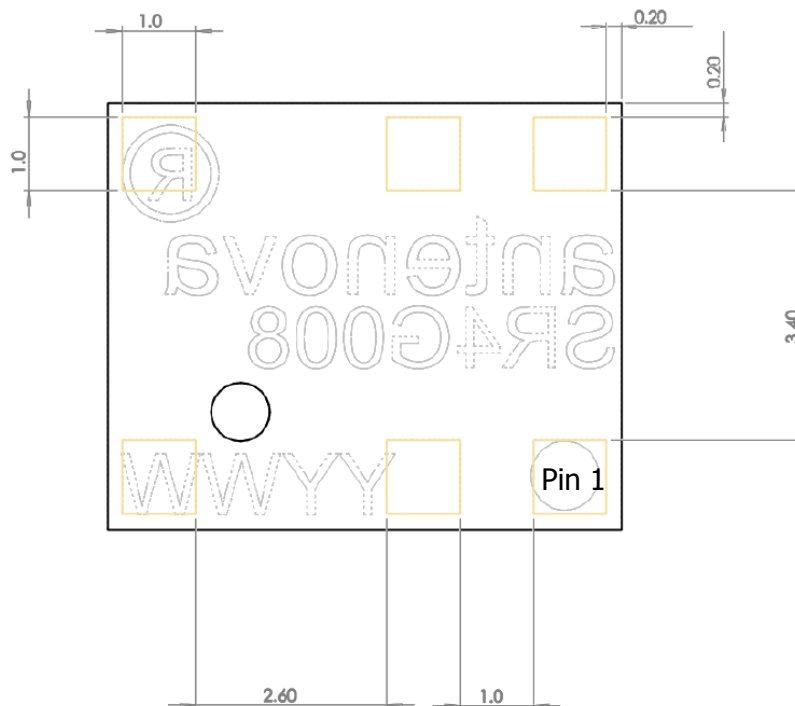

6 solder pads (1.0 x 1.0 mm)

## 9.0 Antenna footprint

The recommended host PCB footprint is below. This is shown as it should be placed on the host PCB.

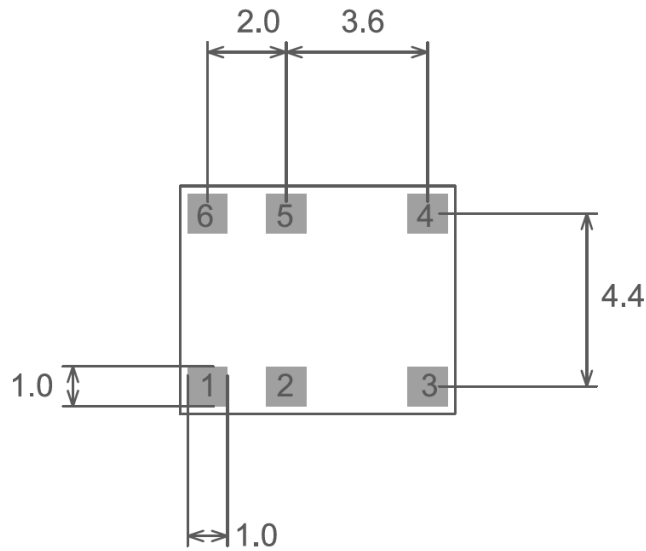

6 copper pads all 1.0 x 1.0 (mm)

\*CAD files of the antenna footprint are available at [www.antenova-m2m.com](http://www.antenova-m2m.com).

## 10.0 Schematic

The circuit for the antenna and the matching components is below. The RF feed connection and GND connections are critical to the function of the antenna, and must be followed as shown. This circuit can be used for the circuit capture of the host PCB.

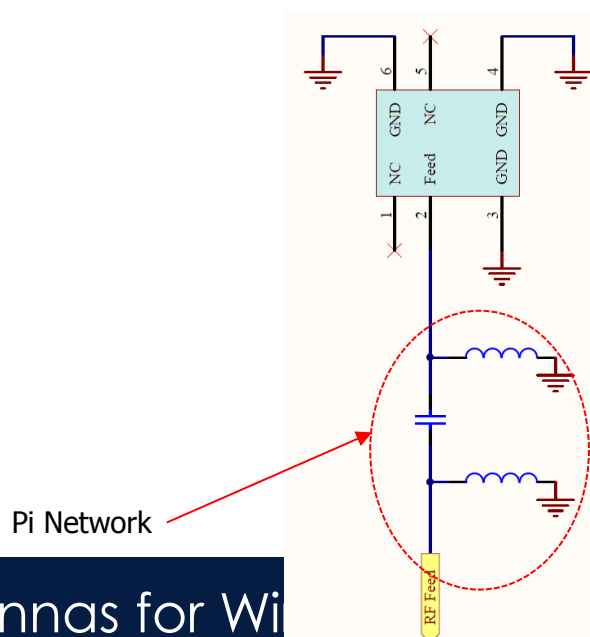

## 11. Electrical Interface

### 11.1 Transmission Line

All transmission lines should be designed to have a characteristic impedance of 50Ω.

- The length of the transmission lines should be kept to a minimum
- Any other parts of the RF system like transceivers, power amplifiers, etc, should also be designed to have an impedance of 50 Ω

Once the material for the PCB has been chosen (PCB thickness and dielectric constant), a coplanar transmission line can easily be designed using any of the commercial software packages for transmission line design. For the chosen PCB thickness, copper thickness and substrate dielectric constant, the program will calculate the appropriate transmission line width and gaps on either side of the track so the characteristic impedance of the co-planar transmission line is 50 Ω.

### 11.2 Matching Circuit

The antenna requires a matching circuit that must be optimized for each product. The matching circuit will require up to three components and the following pad layout should be designed into the device so the correct circuit can be installed.

The Pi matching network must be placed close to the antenna feed to ensure it is more effective in tuning the antenna.

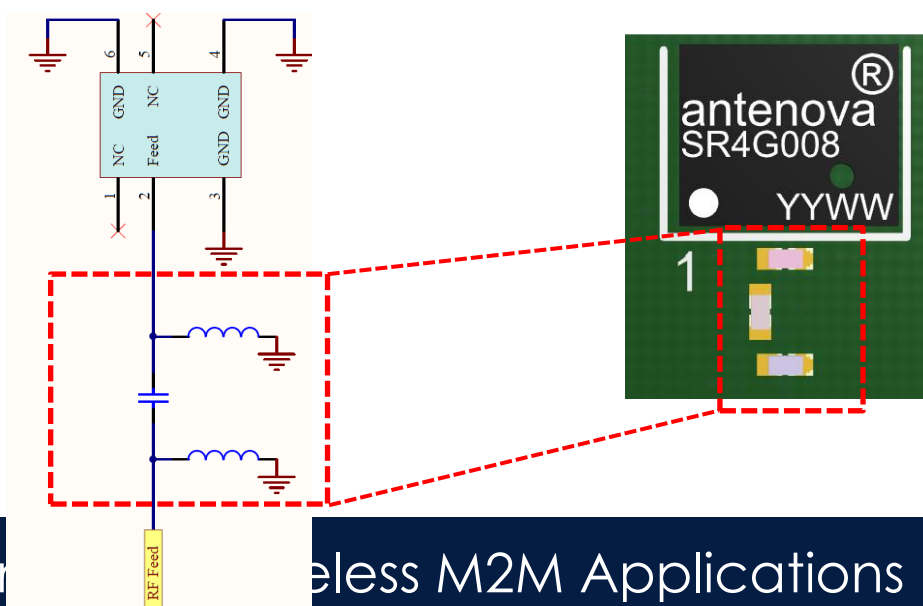

## 12.0 Antenna Integration Guide

### 12.1 Antenna Placement

Whichever the host PCB size used, the antenna should be placed ideally on the host PCB's longest edge at the centre.



Where the centre is not a viable option the antenna can be placed offset on the PCB to within the limits shown below. A minimum of 5mm from either PCB edge should be observed. Where possible this distance should be greater than 5mm.





## 12.2 Host PCB Layout

The host PCB must ensure the footprint and clearance meets the antenna specification. An example of the PCB layout shows the antenna footprint with clearance.

Pins 3, 4 and 6 (GND) are shown directly connecting to the GND with the shortest route. The feed (Pin 2) connects to the matching circuit close to the antenna.

Example host layout

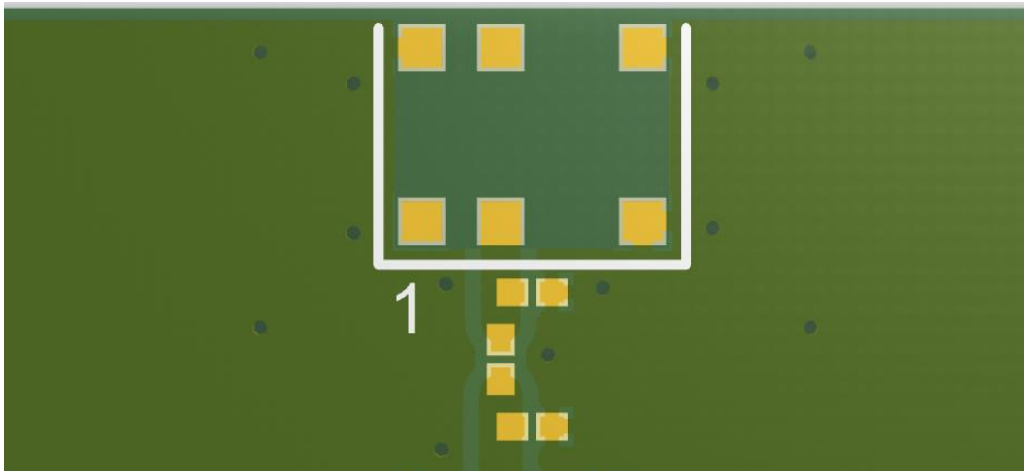

## 12.3 Host PCB Clearance

Below shows the antenna footprint and clearance through all layers on the PCB. Only the antenna pads and connections to feed and GND are present within this clearance area. The clearance area required is 7.0 x 5.8 (mm).

Example host layout

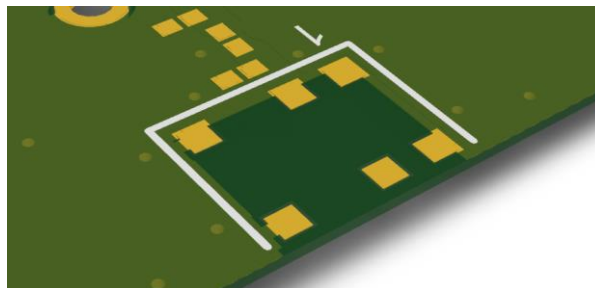

The clear-out area is simply defined as the same size as the antenna. No additional clearance is required.

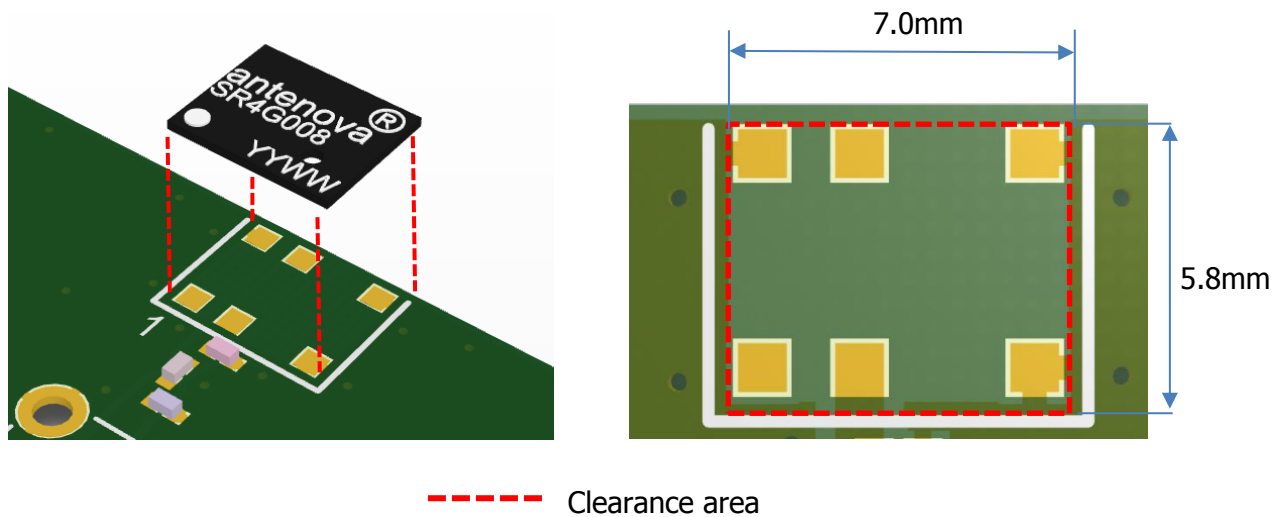

### 13.0 Host PCB Size

The minimum recommended host PCB size to be used is 40 x 20 (mm). Below is the antenna performance vs PCB length.

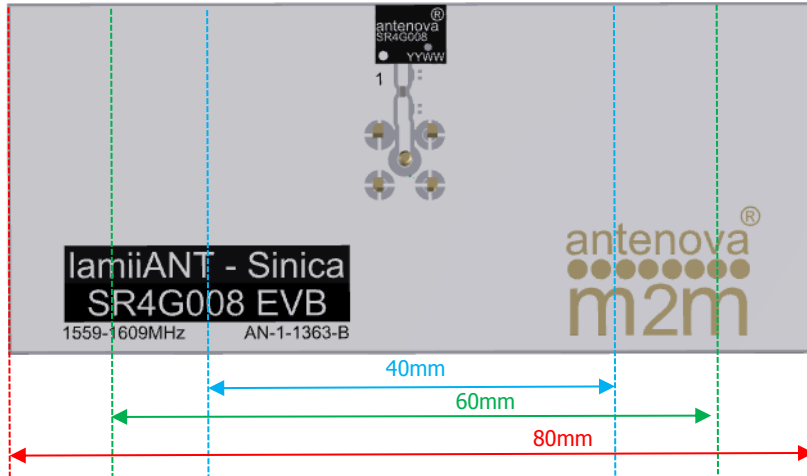

**Passive Efficiency vs. PCB length**  
*All results measured in Antenova's anechoic chamber*

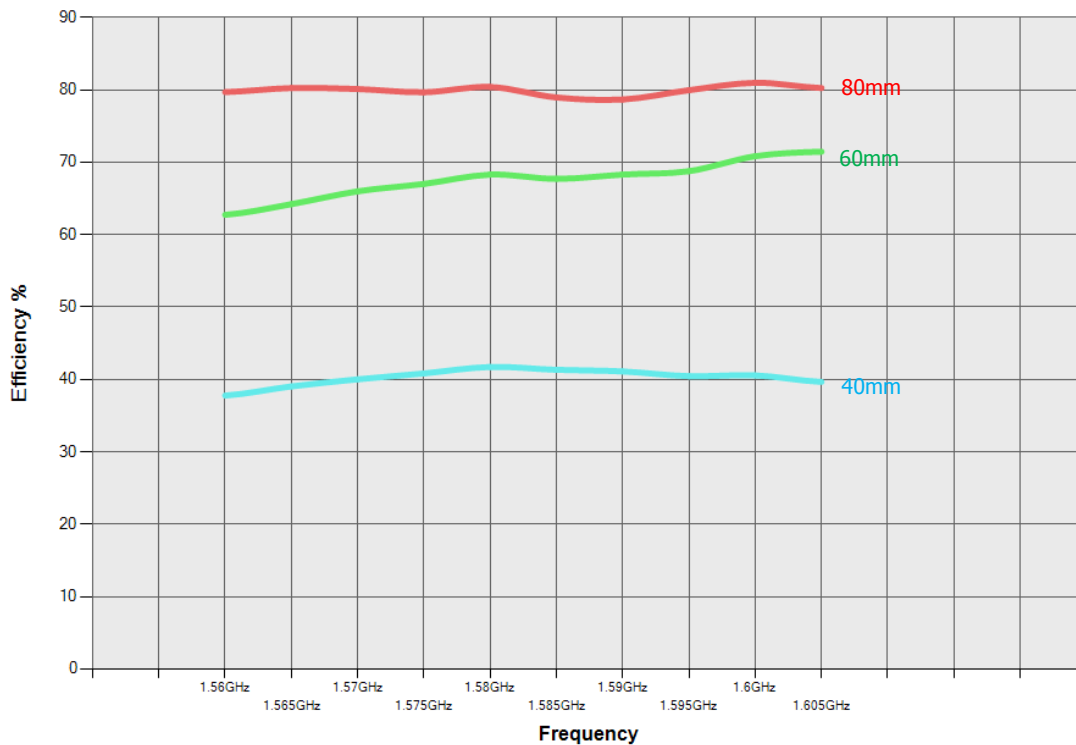

## 14.0 Reference Board

The reference board has been designed for evaluation purposes of SR4G008 includes a SMA female connector.

SR4G008 Evaluation Board

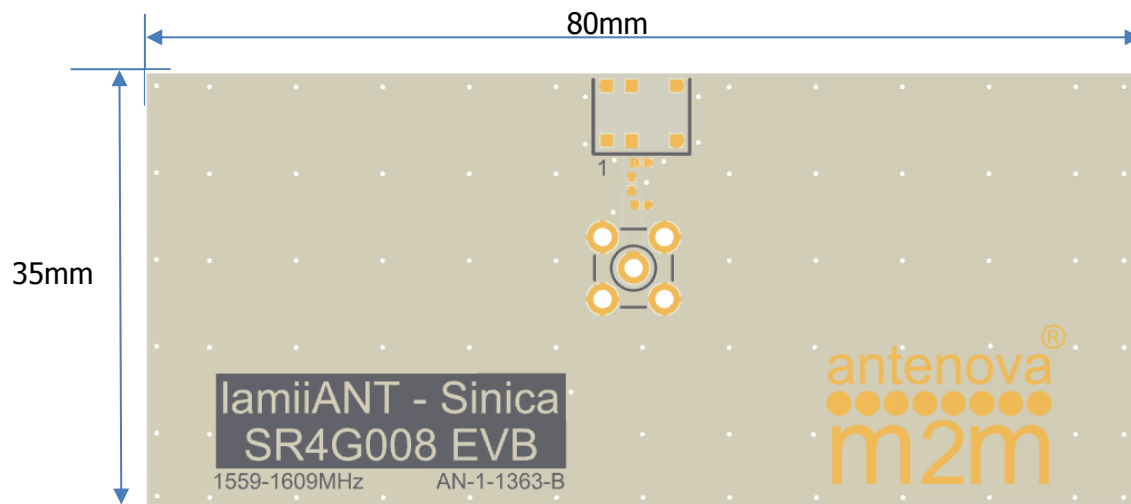

To order a reference board contact [sales@antenna-m2m.com](mailto:sales@antenna-m2m.com).  
Please state if single or two antenna EVB is required.

## 15. Soldering

This antenna is suitable for lead free soldering.

The reflow profile should be adjusted to suit the device, oven and solder paste, while observing the following conditions:

- The maximum temperature should not exceed 240 °C
- However for lead free soldering, a maximum temperature of 255 °C for no more than 20 seconds is permitted.
- The antenna should not be exposed to temperatures exceeding 120 °C more than 3 times during the soldering process.

## 16. Hazardous Material Regulation Conformance

The antenna has been tested to conform to RoHS requirements. A certificate of conformance is available from Antenova M2M's website.

## 17. Packaging

### 17.1 Optimal Storage Conditions

Temperature	-10°C to 40°C
Humidity	Less than 75% RH
Shelf life	18 Months
Storage place	Away from corrosive gas and direct sunlight
Packaging	Reels should be stored in unopened sealed manufacturer's plastic packaging.

**Note: Storage of open reels of antennas is not recommended due to possible oxidization of pads on antennas. If short term storage is necessary, then it is highly recommended that the bag containing the antenna reel is re-sealed and stored in like storage conditions as in above table.**

**The shelf life of the antenna is 2 years, providing the factory seal on the package has not been broken**

## 17.2 Tape Characteristics

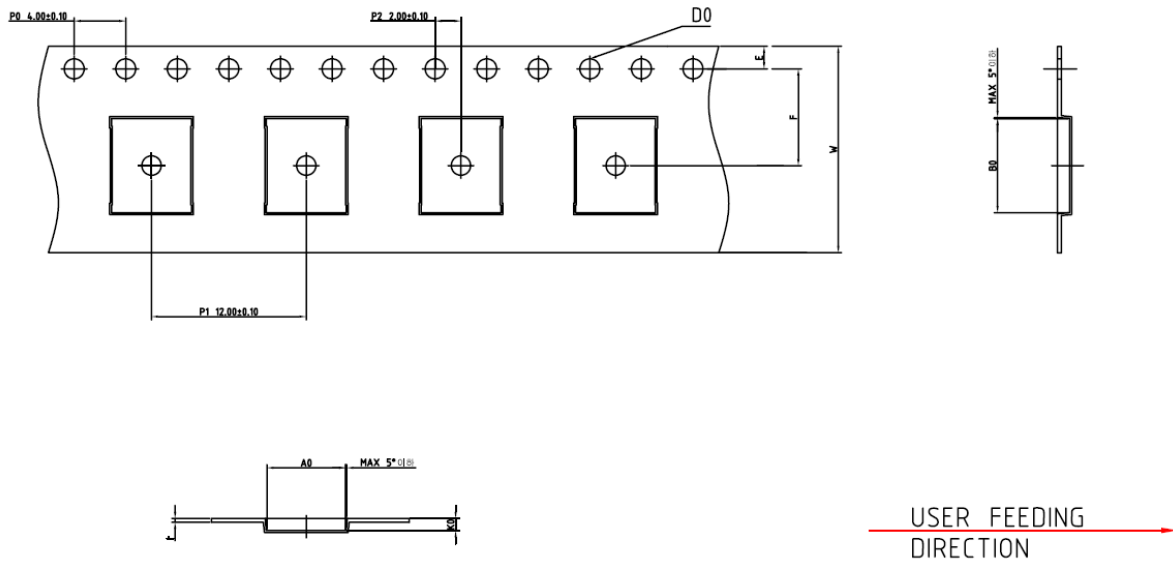

Do	Ao	Bo	P0	P1	P2
1.55 +0.1	6.10 ± 0.1	7.30 ± 0.1	4.00 ± 0.1	12.00 ± 0.1	2.00 ± 0.1

E	F	W	K0
1.75 ± 0.1	7.50 ± 0.1	16.00 ± 0.3	0.95 ± 0.1

Dimensions in mm

### Notes:

- Sprocket hole pitch cumulative tolerance =  $\pm 0.2$
- Chamber not to exceed 1mm in 100mm
- Ao and Bo measured on a plane 0.1mm above the bottom of the pocket.
- K0 measured from a plane on the inside bottom of the pocket to the top surface of the carrier.

### 17.3 Reel Dimensions

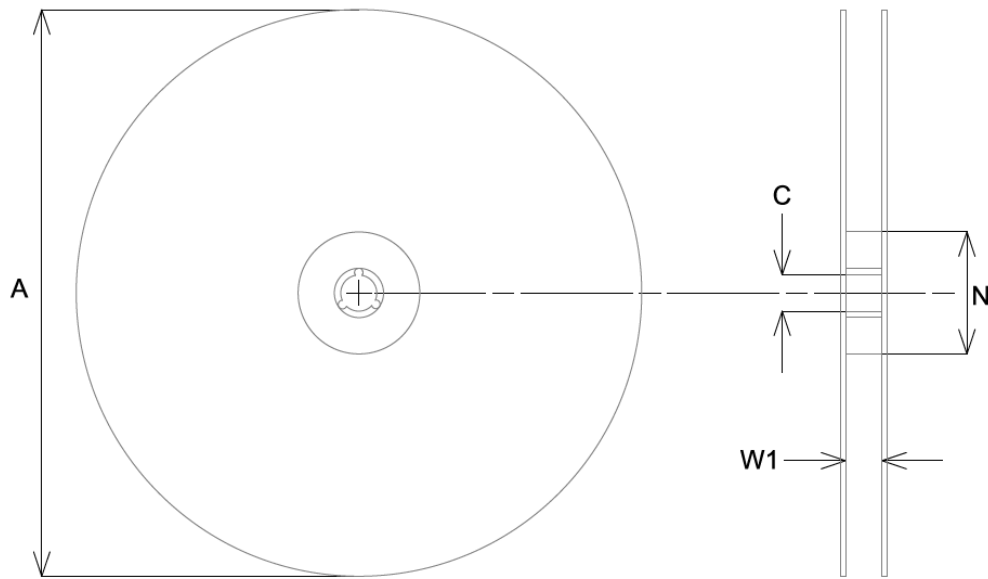

A	C	N	W1
178.0 ± 2.0	13.2 ± 0.5	60.0	14.0

All dimensions in mm

## 17.4 Box Dimensions

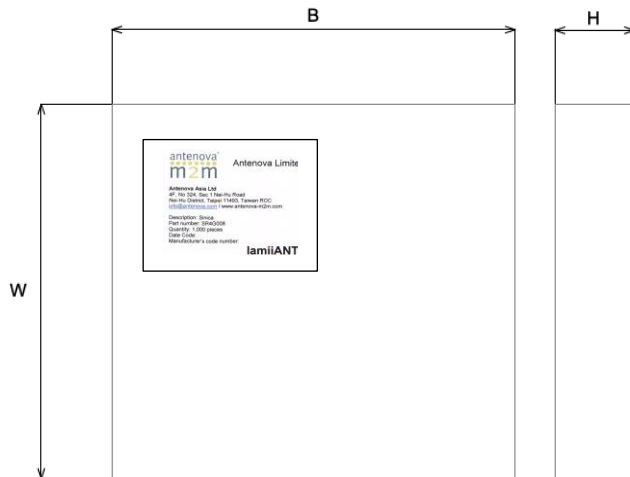

Width (W)	Breadth (B)	Thickness (H)
203mm	188mm	40mm

## 17.5 Bag Properties

Reels are supplied in protective plastic packaging.

## 17.6 Reel Label Information

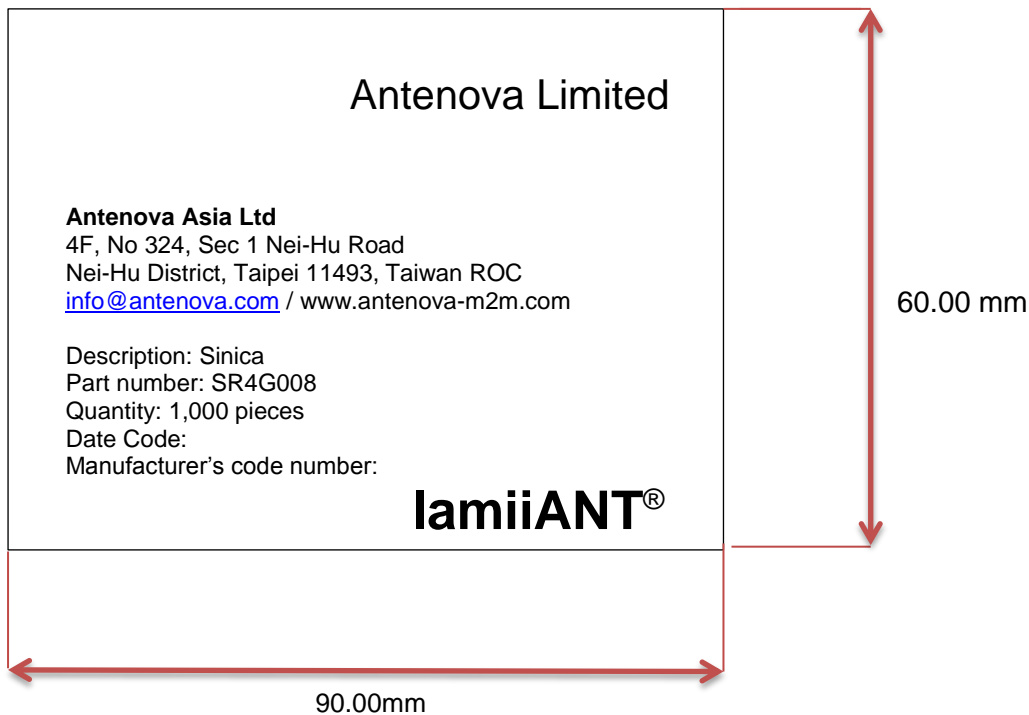





[www.antenova-m2m.com](http://www.antenova-m2m.com)

#### Corporate Headquarters

Antenova Limited  
2<sup>nd</sup> Floor Titan Court  
Bishop Square  
Hatfield  
AL10 9NA  
UK

**Tel:** +44 1233 810600

**Email:** [sales@antenova-m2m.com](mailto:sales@antenova-m2m.com)

#### North America Headquarters

Antenova Limited  
100 Brush Creek Road, Suite 103  
Santa Rosa  
California, 95404  
USA

**Tel:** +1 707 890 5202

**Email:** [sales@antenova-m2m.com](mailto:sales@antenova-m2m.com)

#### Asia Headquarters

Antenova Asia Limited  
4F, No. 324, Sec. 1, Hei-Hu Road  
Hei-Hu District  
Taipei 11493  
Taiwan, ROC

**Tel:** +886 (0) 2 8797 8630

**Fax:** +886 (0) 2 8797 6890

**Email:** [sales@antenova-m2m.com](mailto:sales@antenova-m2m.com)

**Copyright© Antenova Ltd.** All Rights Reserved. Antenova ®, Antenova M2M ®, gigaNOVA ®, the Antenova product family names, and the Antenova and Antenova M2M logos are trademarks and/or registered trademarks of Antenova Ltd. Any other names and/or trademarks belong to their respective companies.

The materials provided herein are believed to be reliable and correct at the time of printing. Antenova does not warrant the accuracy or completeness of the information, text, graphics or other items contained within this information. Antenova further assumes no responsibility for the use of this information, and all such information shall be entirely at the user's risk.



Certificate No: 4598

Antennas for Wireless M2M Applications

## Данный компонент на территории Российской Федерации

### Вы можете приобрести в компании MosChip.

Для оперативного оформления запроса Вам необходимо перейти по данной ссылке:

<http://moschip.ru/get-element>

Вы можете разместить у нас заказ для любого Вашего проекта, будь то серийное производство или разработка единичного прибора.

В нашем ассортименте представлены ведущие мировые производители активных и пассивных электронных компонентов.

Нашей специализацией является поставка электронной компонентной базы двойного назначения, продукции таких производителей как XILINX, Intel (ex.ALTERA), Vicor, Microchip, Texas Instruments, Analog Devices, Mini-Circuits, Amphenol, Glenair.

Сотрудничество с глобальными дистрибьюторами электронных компонентов, предоставляет возможность заказывать и получать с международных складов практически любой перечень компонентов в оптимальные для Вас сроки.

На всех этапах разработки и производства наши партнеры могут получить квалифицированную поддержку опытных инженеров.

Система менеджмента качества компании отвечает требованиям в соответствии с ГОСТ Р ИСО 9001, ГОСТ РВ 0015-002 и ЭС РД 009

### Офис по работе с юридическими лицами:

105318, г.Москва, ул.Щербаковская д.3, офис 1107, 1118, ДЦ «Щербаковский»

Телефон: +7 495 668-12-70 (многоканальный)

Факс: +7 495 668-12-70 (доб.304)

E-mail: [info@moschip.ru](mailto:info@moschip.ru)

Skype отдела продаж:

moschip.ru

moschip.ru\_4

moschip.ru\_6

moschip.ru\_9