

STRADA-2X2-PXL

Fully asymmetric beam designed to highlight pedestrian crossings for left side traffic

TECHNICAL SPECIFICATIONS:

Dimensions	50.0 mm
Height	8 mm
Fastening	pin, screw
ROHS compliant	yes ⓘ

MATERIAL SPECIFICATIONS:

Component	Type	Material	Colour	Finish
STRADA-2X2-PXL	Multi-lens	PMMA	clear	



ORDERING INFORMATION:

Component	Qty in box	MOQ	MPQ	Box weight (kg)
C14896_STRADA-2X2-PXL » Box size: 480 x 280 x 300 mm	800	160	160	7.9

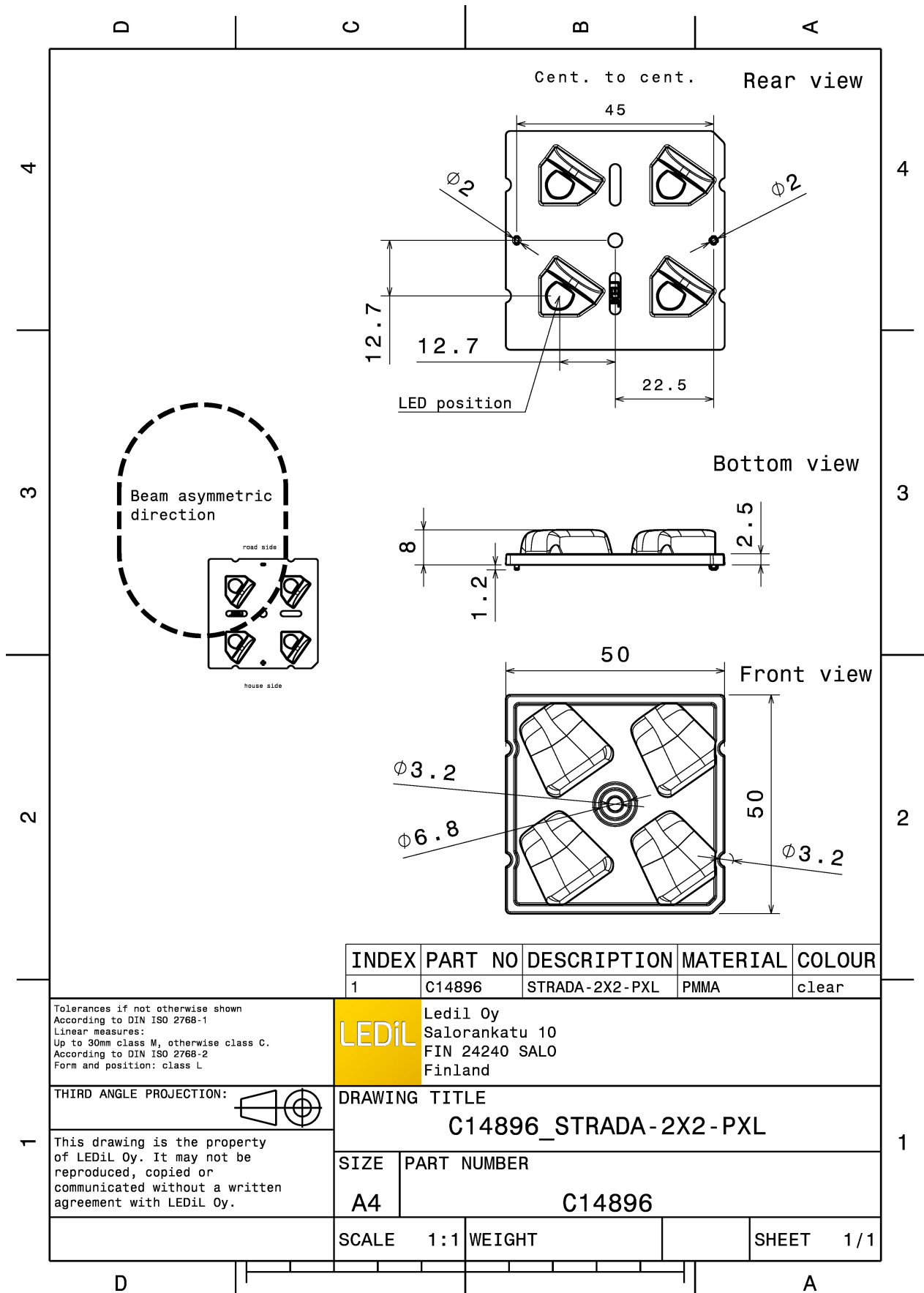

PHOTOMETRIC DATA (MEASURED):



LED XD16
 FWHM Asymmetric
 Efficiency 94 %
 Peak intensity 1.2 cd/lm
 LEDs/each optic 1
 Light colour White
 Required components:

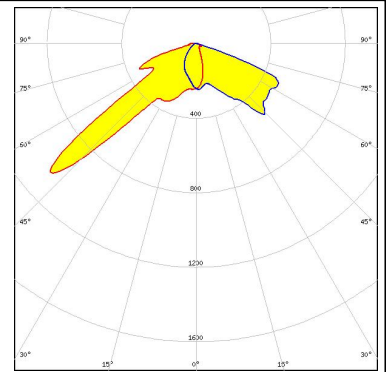

LED LUXEON 5050 Round LES
 FWHM Asymmetric
 Efficiency 94 %
 Peak intensity 0.8 cd/lm
 LEDs/each optic 1
 Light colour White
 Required components:

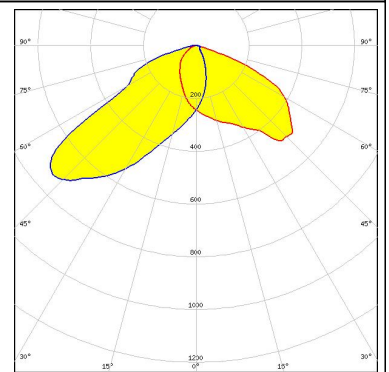

LED LUXEON MZ
 FWHM Asymmetric
 Efficiency 94 %
 Peak intensity 0.9 cd/lm
 LEDs/each optic 1
 Light colour White
 Required components:

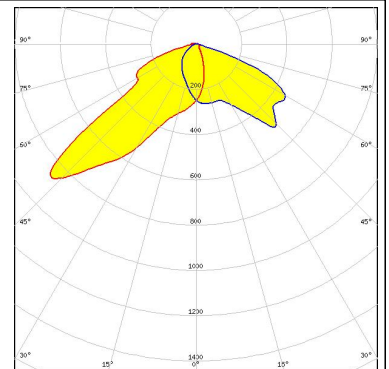

LED LUXEON V
 FWHM Asymmetric
 Efficiency 94 %
 Peak intensity 0.8 cd/lm
 LEDs/each optic 1
 Light colour White
 Required components:

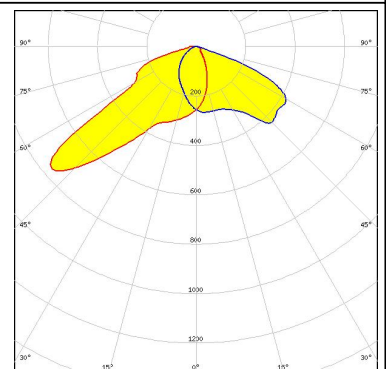
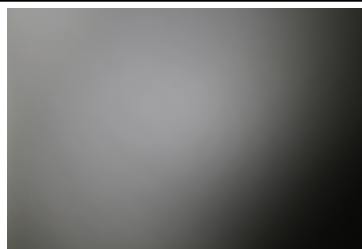

PHOTOMETRIC DATA (MEASURED):



LED NVSW219F
 FWHM Asymmetric
 Efficiency 94 %
 Peak intensity 0.9 cd/lm
 LEDs/each optic 1
 Light colour White
 Required components:

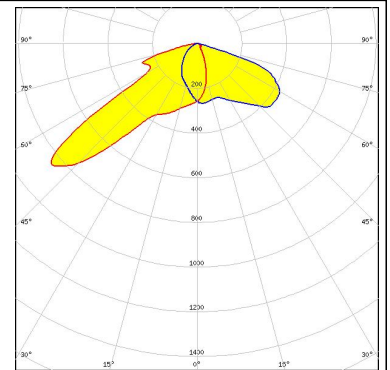

LED NVSW319B
 FWHM Asymmetric
 Efficiency 94 %
 Peak intensity 0.9 cd/lm
 LEDs/each optic 1
 Light colour White
 Required components:

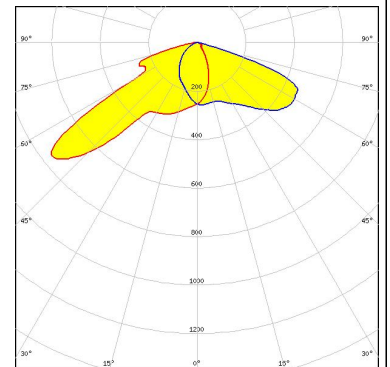

LED NVSxE21A
 FWHM Asymmetric
 Efficiency 94 %
 Peak intensity 1.4 cd/lm
 LEDs/each optic 1
 Light colour White
 Required components:

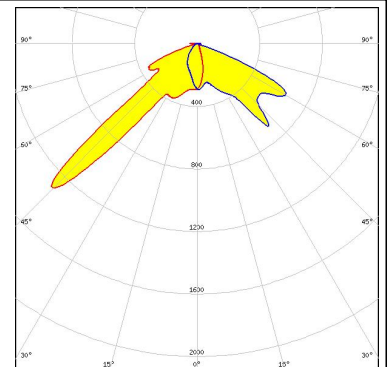

LED OSLOM Square PC
 FWHM Asymmetric
 Efficiency 94 %
 Peak intensity 1.1 cd/lm
 LEDs/each optic 1
 Light colour White
 Required components:

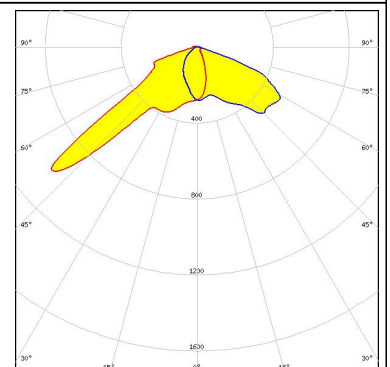

PHOTOMETRIC DATA (MEASURED):

SAMSUNG

LED HiLOM RH16 (LH351C)
 FWHM Asymmetric
 Efficiency 94 %
 Peak intensity 1 cd/lm
 LEDs/each optic 1
 Light colour White
 Required components:

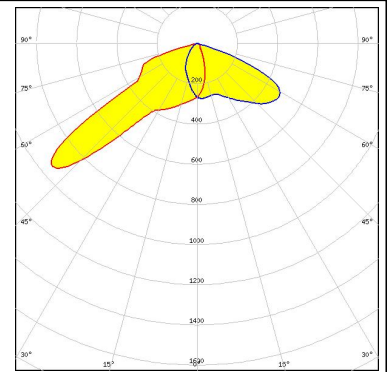

SAMSUNG

LED LH351B
 FWHM Asymmetric
 Efficiency 94 %
 Peak intensity 0.9 cd/lm
 LEDs/each optic 1
 Light colour White
 Required components:

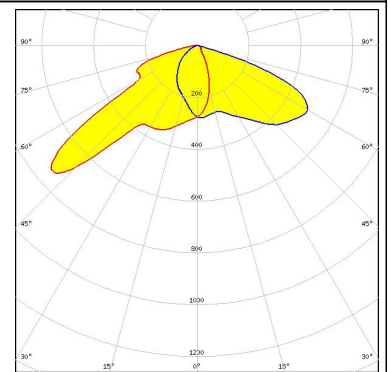

SEOUL SEMICONDUCTOR

LED Z5M3
 FWHM Asymmetric
 Efficiency 94 %
 Peak intensity 0.9 cd/lm
 LEDs/each optic 1
 Light colour White
 Required components:

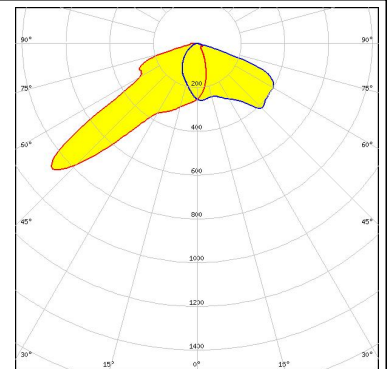

SEOUL SEMICONDUCTOR

LED Z8Y22
 FWHM Asymmetric
 Efficiency 94 %
 Peak intensity 1 cd/lm
 LEDs/each optic 1
 Light colour White
 Required components:

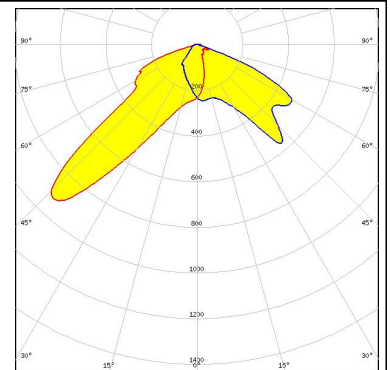
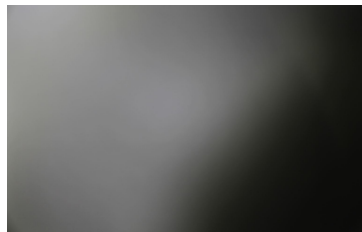

PHOTOMETRIC DATA (MEASURED):

TRIDONIC

LED RLE 2x4 2000lm HP EXC2 OTD
FWHM Asymmetric
Efficiency 94 %
Peak intensity 1.2 cd/lm
LEDs/each optic 1
Light colour White
Required components:

TRIDONIC

LED RLE 2x8 4000lm HP EXC2 OTD
FWHM Asymmetric
Efficiency 94 %
Peak intensity 1.2 cd/lm
LEDs/each optic 1
Light colour White
Required components:

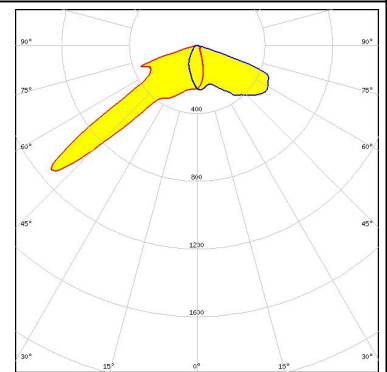

PHOTOMETRIC DATA (SIMULATED):



LED XP-G2
 FWHM Asymmetric
 Efficiency 95 %
 Peak intensity 1.1 cd/lm
 LEDs/each optic 1
 Light colour White
 Required components:

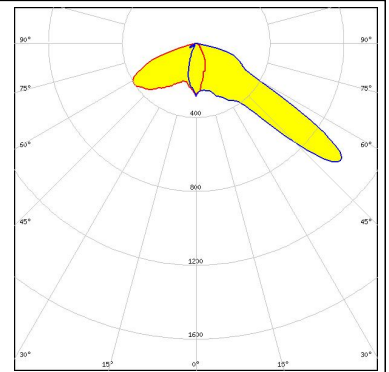

LED XP-G2 HE
 FWHM Asymmetric
 Efficiency 95 %
 Peak intensity 0.9 cd/lm
 LEDs/each optic 1
 Light colour White
 Required components:

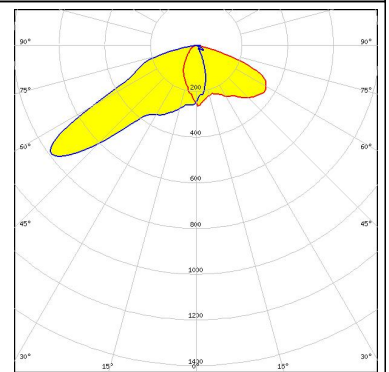

LED XP-G3
 FWHM Asymmetric
 Efficiency 81 %
 Peak intensity 0.8 cd/lm
 LEDs/each optic 1
 Light colour White
 Required components:

Transparent protective cover

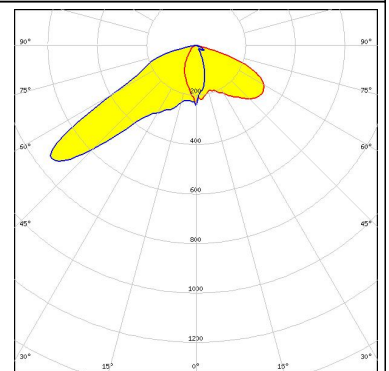

LED LUXEON TX
 FWHM Asymmetric
 Efficiency 95 %
 Peak intensity 1.1 cd/lm
 LEDs/each optic 1
 Light colour White
 Required components:

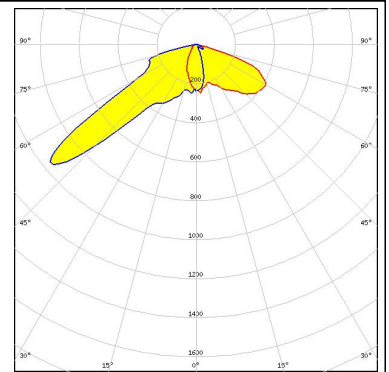

PHOTOMETRIC DATA (SIMULATED):

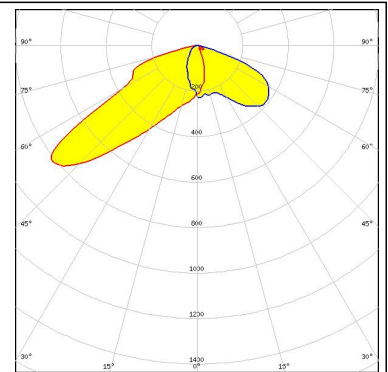
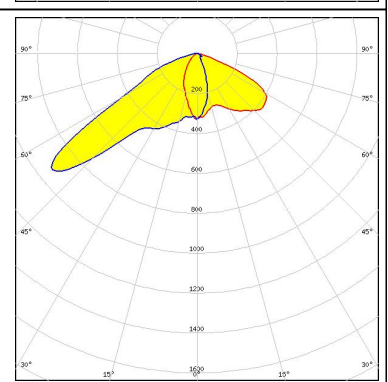
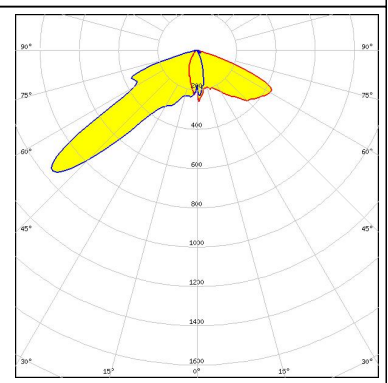
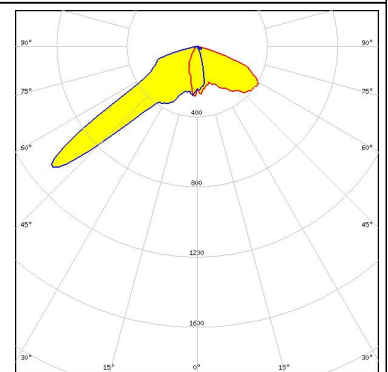
<p>NICHIA</p> <p>LED: NV4WB35AM FWHM: Asymmetric Efficiency: 96 % Peak intensity: 0.9 cd/lm LEDs/each optic: 1 Light colour: White Required components:</p>	
<p>NICHIA</p> <p>LED: NVSW219D FWHM: Asymmetric Efficiency: 94 % Peak intensity: 1.1 cd/lm LEDs/each optic: 1 Light colour: White Required components:</p> <p>Transparent protective cover</p>	
<p>NICHIA</p> <p>LED: NVSxx19B/NVSxx19C FWHM: Asymmetric Efficiency: 92 % Peak intensity: 1 cd/lm LEDs/each optic: 1 Light colour: White Required components:</p>	
<p>OSRAM</p> <p>LED: PrevaLED Brick HP 2x8 FWHM: Asymmetric Efficiency: 93 % Peak intensity: 1.2 cd/lm LEDs/each optic: 1 Light colour: White Required components:</p>	

PHOTOMETRIC DATA (SIMULATED):

OSRAM Opto Semiconductors

LED Duris S8
FWHM Asymmetric
Efficiency 94 %
Peak intensity 0.8 cd/lm
LEDs/each optic 1
Light colour White
Required components:

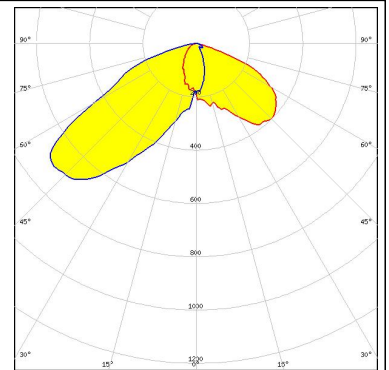

OSRAM Opto Semiconductors

LED OSLOM Square CSSRM2/CSSRM3
FWHM Asymmetric
Efficiency 93 %
Peak intensity 1.2 cd/lm
LEDs/each optic 1
Light colour White
Required components:

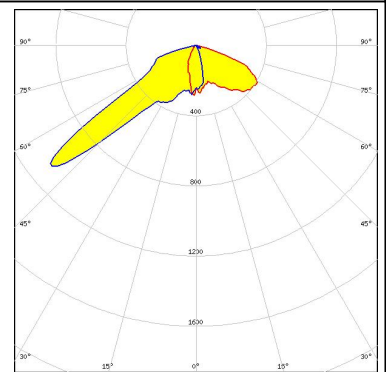

GENERAL INFORMATION:

NOTE: The typical beam angle will be changed by different color, chip size and chip position tolerance. The typical total beam angle is the full angle measured where the luminous intensity is half of the peak value.

MATERIALS:

As part of our continuous research and improvement processes, and to ensure the best possible quality and availability of our products, LEDiL reserves the right to change material grades without notice.

PRODUCT DATA USER AGREEMENT AND DISCLAIMER:

The measured data in the provided downloadable LEDiL Product Datasheets and Mechanical 2D-Drawings is rounded and provided as reference for planning. LEDiL Oy's optical specifications have been verified by conducting performance testing of the products in accordance with the company's quality system. The reported data are averaged results of multiple measurements with typical variation. LEDiL Oy reserves the right to without prior notification make changes and improvements to its products.

LEDiL Oy assumes neither warranty, nor guarantee nor any other liability of any kind for the contents and correctness of the provided data. The provided data has been generated with highest diligence but the provided data may in reality not represent the complete possible variation range of all intrinsic parameters. Therefore, in certain cases a deviation from the provided data could occur.

LEDiL Oy reserves the right to undertake technical changes of its products without further notification which could lead to changes in the provided data. LEDiL Oy assumes no liability of any kind for the possible deviation from any provided data or any other damage resulting from the usage of the provided data.

The user agrees to this disclaimer and user agreement with the download or usage of the provided files.

LEDiL Oy

Joensuunkatu 13
FI-24240 SALO
Finland

LEDiL Inc.

228 West Page Street
Suite D
Sycamore IL 60178
USA

Local sales and technical support

[www.ledil.com/
where_to_buy](http://www.ledil.com/where_to_buy)

Shipping locations

Salo, Finland
Hong Kong, China

Distribution Partners

[www.ledil.com/
where_to_buy](http://www.ledil.com/where_to_buy)

Данный компонент на территории Российской Федерации

Вы можете приобрести в компании MosChip.

Для оперативного оформления запроса Вам необходимо перейти по данной ссылке:

<http://moschip.ru/get-element>

Вы можете разместить у нас заказ для любого Вашего проекта, будь то серийное производство или разработка единичного прибора.

В нашем ассортименте представлены ведущие мировые производители активных и пассивных электронных компонентов.

Нашей специализацией является поставка электронной компонентной базы двойного назначения, продукции таких производителей как XILINX, Intel (ex.ALTERA), Vicor, Microchip, Texas Instruments, Analog Devices, Mini-Circuits, Amphenol, Glenair.

Сотрудничество с глобальными дистрибьюторами электронных компонентов, предоставляет возможность заказывать и получать с международных складов практически любой перечень компонентов в оптимальные для Вас сроки.

На всех этапах разработки и производства наши партнеры могут получить квалифицированную поддержку опытных инженеров.

Система менеджмента качества компании отвечает требованиям в соответствии с ГОСТ Р ИСО 9001, ГОСТ РВ 0015-002 и ЭС РД 009

Офис по работе с юридическими лицами:

105318, г.Москва, ул.Щербаковская д.3, офис 1107, 1118, ДЦ «Щербаковский»

Телефон: +7 495 668-12-70 (многоканальный)

Факс: +7 495 668-12-70 (доб.304)

E-mail: info@moschip.ru

Skype отдела продаж:

moschip.ru

moschip.ru_4

moschip.ru_6

moschip.ru_9