

# Single Tine SMT 18-24 AWG: WTB

9176-650

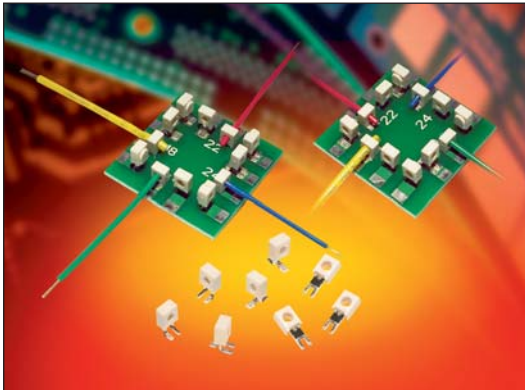

The market and applications for simple and reliable discrete Wire-to-Board (WTB) connectors continue to evolve. Developed for harsh industrial and automotive applications, Insulation Displacement Connectors (IDC) have been used in hundreds of applications connecting wires to PCB's from transportation wiring to every day LED lighting and smart meter/sensor connections. Size, performance and simplicity have been the key factors for selecting this connector when long term reliability is critical.

This single contact version of the proven 9176 family of connectors offers a lower cost solution to the market with only a 10% reduction in current rating. The SMT footprint is backward compatible with the standard dual contact configurations; offers all the same wire gauges and termination benefits of the integrated cap and provides a 10% height reduction.

## APPLICATIONS

- Machine Controls: motors, drives, solenoids, sensors, fans and pumps
- Commercial Buildings: controls, security, fire and sensors
- Smart Grid: meters, breakers and panels
- SSL/LED: bulbs, fixtures, signage and streetlights
- Application notes: reference 201-01-142

## FEATURES AND BENEFITS

- IDC contact provides a gas-tight connection to the PCB for long term reliability
- Plastic cap retains the contact in position prior to automatic placement, then acts as the assembly tool to terminate the wires; no special tooling.
- Tested to automotive levels on shock, vibration and temperature cycling for reliability
- Identical contact and footprint pattern to the existing 9176 for full backward compatibility and functionality
- The IDC contact reduces the total applied cost versus solder or crimp processes
- Connectors are available in two configurations for maximum flexibility: End and Through Wire

## ELECTRICAL

- Current Rating: See matrix below
- Voltage Rating: 600 VAC

## ENVIRONMENTAL

- Operating Temperature: -40°C to +125°C

## MECHANICAL

- Contact Material: Phosphor Bronze
- Contact Plating: Tin over Nickel
- Durability: 3 Cycles

## HOW TO ORDER

**00** Prefix  
**9176** Series  
**001** Number of Ways  
001 = 1

**65X** Contact Style

**9** Color Option  
9 = UL White

**X** Cap Options

**6** Plating Option  
Tin Plated

Code	Description	Accepted Wire Gauge	Wire Gauges
650	Capped IDC Connector SMT Mount	18 AWG Stranded	ø1.6-2.1
651		20 AWG Solid and Stranded	ø1.6-2.1
652		22 AWG Solid and Stranded	ø1.1-1.6
653		24 AWG Solid and Stranded	ø1.1-1.6

Code	Cap Option	Description	Details
0	Through Wire	Allows wire to be terminated at any point	See page 2
9	Wire Stop	Terminates end of wire End protected by stop face	See page 3

## CURRENT RATING

18AWG	20AWG	22AWG	24AWG
9A	8A	6A	5A

Certification: UL File #E90723



# Single Tine SMT 18-24 AWG: WTB

9176-650

## 18-24 AWG 1 WAY IDC CONNECTOR THROUGH WIRE CAPPED

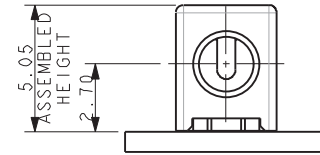
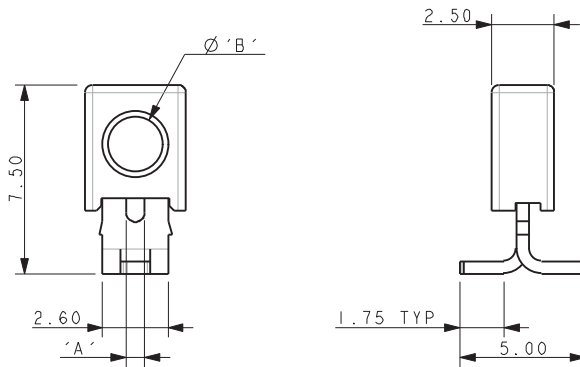
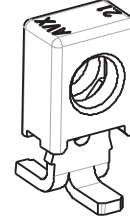
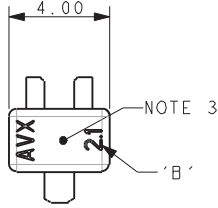

Code	Accepted Wire Gauge	A	Wire Insulation	B
650	18 AWG Stranded	0.74	Ø 1.6-2.1	2.1
651	20 AWG Solid or Stranded	0.60	Ø 1.6-2.1	2.1
652	22 AWG Solid or Stranded	0.47	Ø 1.1-1.6	1.6
653	24 AWG Solid or Stranded	0.37	Ø 1.1-1.6	1.6

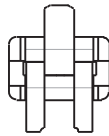

## SUGGESTED PCB LAYOUT

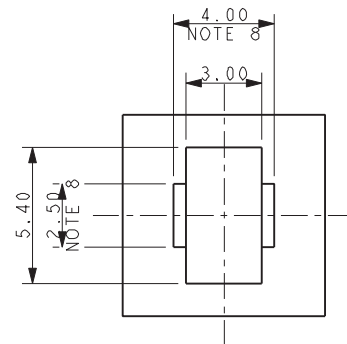

## PACKING DETAILS

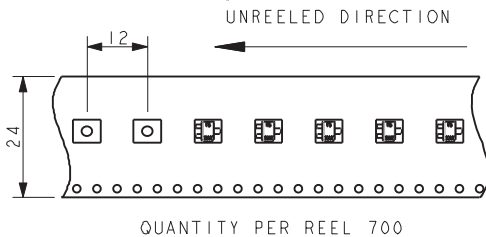
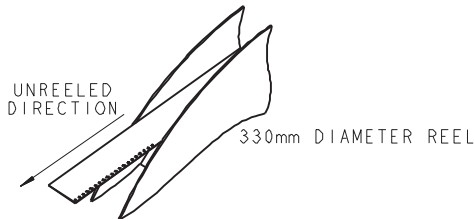

### NOTES:

- 1 WAY CONNECTOR FOR IDC WIRE TO BOARD CONNECTION, PRE-ASSEMBLED THROUGH WIRE CAP, CODE SEE PAGE 1.
- CONTACT/CAP TO MATCH 20AWG-24AWG SOLID AND STRANDED WIRES, 18AWG WILL ONLY ACCEPT STRANDED WIRES, SEE TABLE.
- FLAT FACE ON TOP OF CAP TO AID PICK AND PLACE ASSEMBLY, MAXIMUM DIAMETER 1.8MM.
- FOR FULL PRODUCT SPECIFICATION ON STANDARD CONNECTORS REFER TO ELCO SPEC 201-01-163.
- ASSEMBLY PROCEDURE, REFER TO APPLICATION NOTES 201-01-142.
- GENERAL TOLERANCE  $\pm 0.20$  UNLESS STATED.
- PACKED IN TAPE AND REEL, QUANTITY PER REEL 700.
- CONNECTOR OUTLINE.
- CONTACT MATERIAL: TIN PLATED COPPER ALLOY.
- INSULATION MATERIAL: HIGH TEMPERATURE NYLON, GLASS FILLED, UL94 V-O. COLOR REFER TO PAGE 1.

# Single Tine SMT 18-24 AWG: WTB

9176-650

## 18-24 AWG 1 WAY IDC CONNECTOR WIRE STOP CAPPED

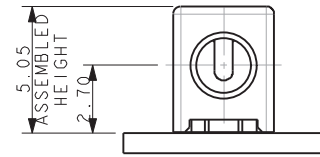
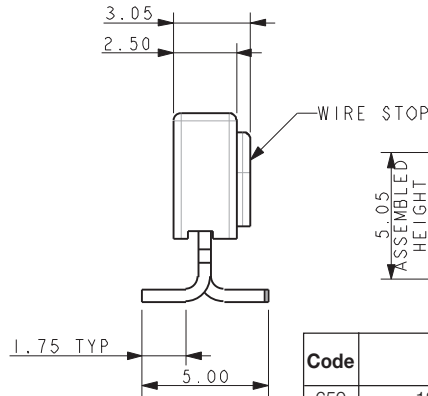
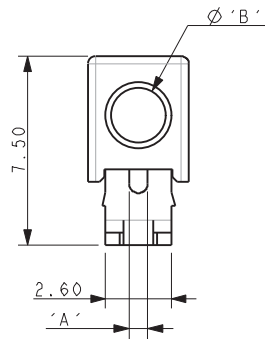
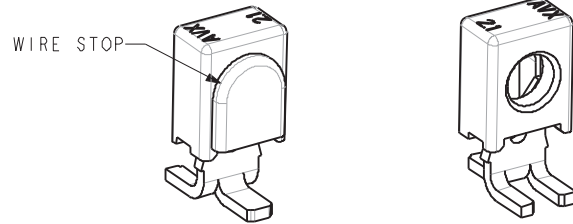
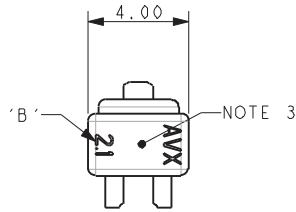

Code	Accepted Wire Gauge	A	Wire Insulation	B
650	18 AWG Stranded	0.74	Ø 1.6-2.1	2.1
651	20 AWG Solid or Stranded	0.60	Ø 1.6-2.1	2.1
652	22 AWG Solid or Stranded	0.47	Ø 1.1-1.6	1.6
653	24 AWG Solid or Stranded	0.37	Ø 1.1-1.6	1.6

## SUGGESTED PCB LAYOUT

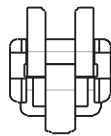

## PACKING DETAILS

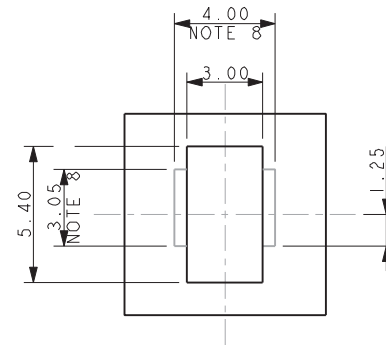
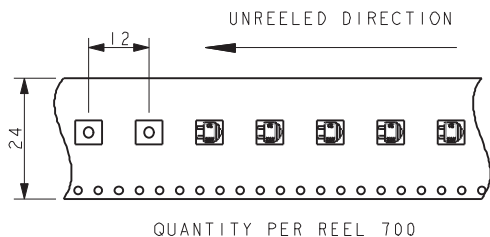
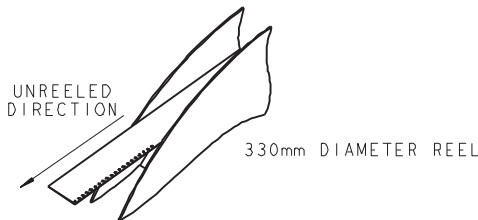

### NOTES:

- 1 WAY CONNECTOR FOR IDC WIRE TO BOARD CONNECTION, PRE-ASSEMBLED WIRE STOP CAP, CODE SEE PAGE 1.
- CONTACT/CAP TO MATCH 20AWG-24AWG SOLID AND STRANDED WIRES, 18AWG WILL ONLY ACCEPT STRANDED WIRES, SEE TABLE.
- FLAT FACE ON TOP OF CAP TO AID PICK AND PLACE ASSEMBLY, MAXIMUM DIAMETER 1.8MM.
- FOR FULL PRODUCT SPECIFICATION ON STANDARD CONNECTORS REFER TO ELCO SPEC 201-01-163.
- ASSEMBLY PROCEDURE, REFER TO APPLICATION NOTES 201-01-142.
- GENERAL TOLERANCE  $\pm 0.20$  UNLESS STATED.
- PACKED IN TAPE AND REEL, QUANTITY PER REEL 700.
- CONNECTOR OUTLINE.
- CONTACT MATERIAL: TIN PLATED COPPER ALLOY.
- INSULATION MATERIAL: HIGH TEMPERATURE NYLON, GLASS FILLED, UL94 V-O. COLOR REFER TO PAGE 1.
- WIRE STOP CAP PROTECTS END OF WIRE.

**18-24 AWG ASSEMBLED CAPPE IDC CONNECTORS**

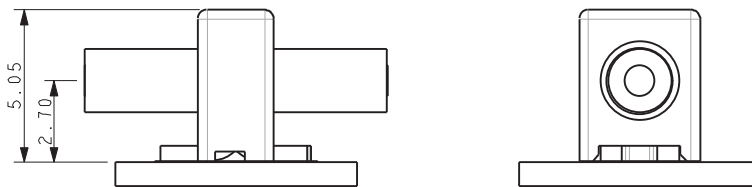

**NOMINAL ASSEMBLED HEIGHTS**

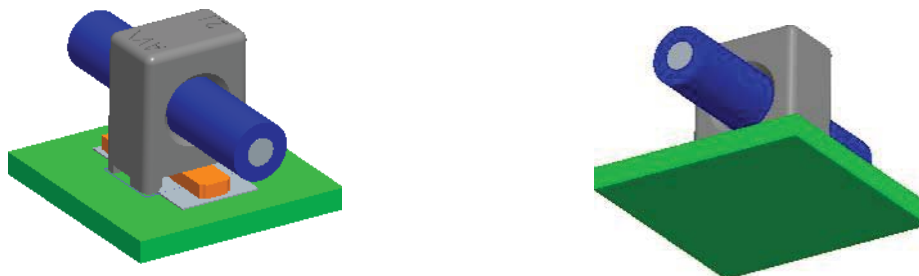

**TYPICAL THROUGH WIRE ASSEMBLIES**



**TYPICAL WIRE STOP ASSEMBLIES**

## Данный компонент на территории Российской Федерации

### Вы можете приобрести в компании MosChip.

Для оперативного оформления запроса Вам необходимо перейти по данной ссылке:

<http://moschip.ru/get-element>

Вы можете разместить у нас заказ для любого Вашего проекта, будь то серийное производство или разработка единичного прибора.

В нашем ассортименте представлены ведущие мировые производители активных и пассивных электронных компонентов.

Нашей специализацией является поставка электронной компонентной базы двойного назначения, продукции таких производителей как XILINX, Intel (ex.ALTERA), Vicor, Microchip, Texas Instruments, Analog Devices, Mini-Circuits, Amphenol, Glenair.

Сотрудничество с глобальными дистрибьюторами электронных компонентов, предоставляет возможность заказывать и получать с международных складов практически любой перечень компонентов в оптимальные для Вас сроки.

На всех этапах разработки и производства наши партнеры могут получить квалифицированную поддержку опытных инженеров.

Система менеджмента качества компании отвечает требованиям в соответствии с ГОСТ Р ИСО 9001, ГОСТ РВ 0015-002 и ЭС РД 009

### Офис по работе с юридическими лицами:

105318, г.Москва, ул.Щербаковская д.3, офис 1107, 1118, ДЦ «Щербаковский»

Телефон: +7 495 668-12-70 (многоканальный)

Факс: +7 495 668-12-70 (доб.304)

E-mail: [info@moschip.ru](mailto:info@moschip.ru)

Skype отдела продаж:

moschip.ru

moschip.ru\_4

moschip.ru\_6

moschip.ru\_9