

MAX5700/MAX5701/MAX5702

Ultra-Small, Dual-Channel, 8-/10-/12-Bit Buffered Output DACs with Internal Reference and SPI Interface

General Description

The MAX5700/MAX5701/MAX5702 2-channel, low-power, 8-/10-/12-bit, voltage-output digital-to-analog converters (DACs) include output buffers and an internal reference that is selectable to be 2.048V, 2.500V, or 4.096V. The MAX5700/MAX5701/MAX5702 accept a wide supply voltage range of 2.7V to 5.5V with extremely low power (1.5mW) consumption to accommodate most low-voltage applications. A precision external reference input allows rail-to-rail operation and presents a 100kΩ (typ) load to an external reference.

The MAX5700/MAX5701/MAX5702 have an a 50MHz 3-wire SPI/QSPI™/MICROWIRE®/DSP-compatible serial interface. The DAC output is buffered and has a low supply current of less than 250μA per channel and a low offset error of ±0.5mV (typ). On power-up, the MAX5700/MAX5701/MAX5702 reset the DAC outputs to zero, providing additional safety for applications that drive valves or other transducers which need to be off on power-up. The internal reference is initially powered down to allow use of an external reference. The MAX5700/MAX5701/MAX5702 allow simultaneous output updates using software LOAD commands.

A clear logic input ($\overline{\text{CLR}}$) allows the contents of the CODE and the DAC registers to be cleared asynchronously and sets the DAC outputs to zero. The MAX5700/MAX5701/MAX5702 are available in a 10-pin μMAX® and an ultra-small, 10-pin TDFN package and are specified over the -40°C to +125°C temperature range.

Applications

- Programmable Voltage and Current Sources
- Gain and Offset Adjustment
- Automatic Tuning and Optical Control
- Power Amplifier Control and Biasing
- Process Control and Servo Loops
- Portable Instrumentation
- Data Acquisition

Ordering Information appears at end of data sheet.

QSPI is a trademark of Motorola, Inc.

MICROWIRE is a registered trademark of National Semiconductor Corporation.

μMAX is a registered trademark of Maxim Integrated Products, Inc.

Benefits and Features

- ◆ **Two High-Accuracy DAC Channels**
 - ◇ 12-Bit Accuracy Without Adjustment
 - ◇ ±1 LSB INL Buffered Voltage Output
 - ◇ Monotonic Over All Operating Conditions
 - ◇ Independent Mode Settings for Each DAC
- ◆ **Three Precision Selectable Internal References**
 - ◇ 2.048V, 2.500V, or 4.096V
- ◆ **Internal Output Buffer**
 - ◇ Rail-to-Rail Operation with External Reference
 - ◇ 4.5μs Settling Time
 - ◇ Outputs Directly Drive 2kΩ Loads
- ◆ **Small 5mm x 3mm 10-Pin μMAX or Ultra-Small 3mm x 3mm 10-Pin TDFN Package**
- ◆ **Wide 2.7V to 5.5V Supply Range**
- ◆ **Separate 1.8V to 5.5V V_{DDIO} Power-Supply Input**
- ◆ **50MHz 3-Wire SPI/QSPI/MICROWIRE/DSP Compatible Serial Interface**
- ◆ **Power-On-Reset to Zero-Scale DAC Output**
- ◆ **$\overline{\text{CLR}}$ For Asynchronous Control**
- ◆ **Three Software-Selectable Power-Down Output Impedances**
 - ◇ 1kΩ, 100kΩ, or High Impedance
- ◆ **Low 350μA Supply Current at 3V V_{DD}**

Functional Diagram

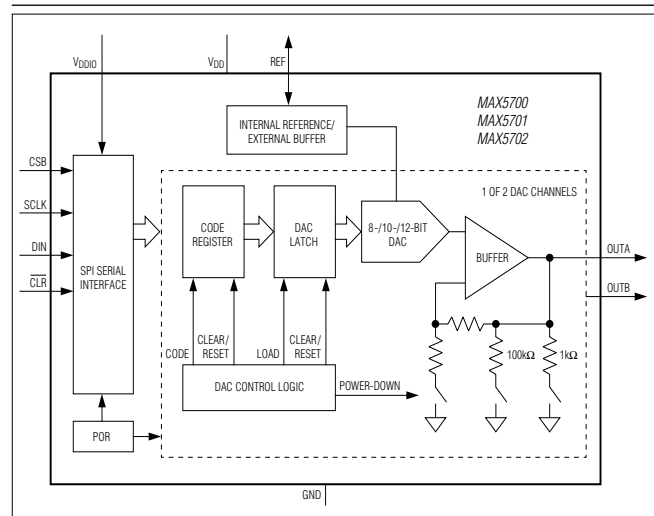

For related parts and recommended products to use with this part, refer to: www.maximintegrated.com/MAX5700.related

For pricing, delivery, and ordering information, please contact Maxim Direct at 1-888-629-4642, or visit Maxim's website at www.maximintegrated.com.

MAX5700/MAX5701/MAX5702

Ultra-Small, Dual-Channel, 8-/10-/12-Bit Buffered Output DACs with Internal Reference and SPI Interface

ABSOLUTE MAXIMUM RATINGS

V_{DD} , V_{DDIO} to GND	-0.3V to +6V	Maximum Continuous Current into Any Pin	± 50 mA
OUT ₋ , REF to GND.....	-0.3V to the lower of ($V_{DD} + 0.3$ V) and +6V	Operating Temperature Range.....	-40°C to +125°C
CSB, SCLK, $\overline{\text{CLR}}$ to GND.....	-0.3V to +6V	Storage Temperature Range.....	-65°C to +150°C
DIN to GND	-0.3V to the lower of ($V_{DDIO} + 0.3$ V) and +6V	Lead Temperature (soldering, 10s)	+300°C
Continuous Power Dissipation ($T_A = +70^\circ\text{C}$)		Soldering Temperature (reflow)	+260°C
μMAX (derate at 8.8mW/°C above 70°C).....	707mW		
TDFN (derate at 24.4mW/°C above 70°C).....	1951mW		

Stresses beyond those listed under "Absolute Maximum Ratings" may cause permanent damage to the device. These are stress ratings only, and functional operation of the device at these or any other conditions beyond those indicated in the operational sections of the specifications is not implied. Exposure to absolute maximum rating conditions for extended periods may affect device reliability.

PACKAGE THERMAL CHARACTERISTICS (Note 1)

μMAX	TDFN		
Junction-to-Ambient Thermal Resistance (θ_{JA})	113°C/W	Junction-to-Ambient Thermal Resistance (θ_{JA})	41°C/W
Junction-to-Case Thermal Resistance (θ_{JC})	42°C/W	Junction-to-Case Thermal Resistance (θ_{JC})	9°C/W

Note 1: Package thermal resistances were obtained using the method described in JEDEC specification JESD51-7, using a four-layer board. For detailed information on package thermal considerations, refer to www.maximintegrated.com/thermal-tutorial.

ELECTRICAL CHARACTERISTICS

($V_{DD} = 2.7$ V to 5.5V, $V_{DDIO} = 1.8$ V to 5.5V, $V_{GND} = 0$ V, $C_L = 200$ pF, $R_L = 2$ k Ω , $T_A = -40^\circ\text{C}$ to +125°C, unless otherwise noted. Typical values are at $T_A = +25^\circ\text{C}$.) (Note 2)

PARAMETER	SYMBOL	CONDITIONS	MIN	TYP	MAX	UNITS
DC PERFORMANCE (Note 3)						
Resolution and Monotonicity	N	MAX5700	8			Bits
		MAX5701	10			
		MAX5702	12			
Integral Nonlinearity (Note 4)	INL	MAX5700	-0.25	± 0.05	+0.25	LSB
		MAX5701	-0.5	± 0.25	+0.5	
		MAX5702	-1	± 0.5	+1	
Differential Nonlinearity (Note 4)	DNL	MAX5700	-0.25	± 0.05	+0.25	LSB
		MAX5701	-0.5	± 0.1	+0.5	
		MAX5702	-1	± 0.2	+1	
Offset Error (Note 5)	OE		-5	± 0.5	+5	mV
Offset Error Drift				± 10		$\mu\text{V}/^\circ\text{C}$
Gain Error (Note 5)	GE		-1.0	± 0.1	+1.0	%FS
Gain Temperature Coefficient		With respect to V_{REF}		± 3.0		ppm of FS/°C
Zero-Scale Error			0		10	mV
Full-Scale Error		With respect to V_{REF}	-0.5		+0.5	%FS

MAX5700/MAX5701/MAX5702

Ultra-Small, Dual-Channel, 8-/10-/12-Bit Buffered Output DACs with Internal Reference and SPI Interface

ELECTRICAL CHARACTERISTICS (continued)

($V_{DD} = 2.7V$ to $5.5V$, $V_{DDIO} = 1.8V$ to $5.5V$, $V_{GND} = 0V$, $C_L = 200pF$, $R_L = 2k\Omega$, $T_A = -40^\circ C$ to $+125^\circ C$, unless otherwise noted. Typical values are at $T_A = +25^\circ C$.) (Note 2)

PARAMETER	SYMBOL	CONDITIONS		MIN	TYP	MAX	UNITS
DAC OUTPUT CHARACTERISTICS							
Output Voltage Range (Note 6)		No load		0		V_{DD}	V
		2k Ω load to GND		0		$V_{DD} - 0.2$	
		2k Ω load to V_{DD}		0.2		V_{DD}	
Load Regulation		$V_{OUT} = V_{FS}/2$	$V_{DD} = 3V \pm 10\%$, $ I_{OUT} \leq 5mA$		300		$\mu V/mA$
			$V_{DD} = 5V \pm 10\%$, $ I_{OUT} \leq 10mA$		300		
DC Output Impedance		$V_{OUT} = V_{FS}/2$	$V_{DD} = 3V \pm 10\%$, $ I_{OUT} \leq 5mA$		0.3		Ω
			$V_{DD} = 5V \pm 10\%$, $ I_{OUT} \leq 10mA$		0.3		
Maximum Capacitive Load Handling	C_L				500		pF
Resistive Load Handling	R_L			2			k Ω
Short-Circuit Output Current		$V_{DD} = 5.5V$	Sourcing (output shorted to GND)		30		mA
			Sinking (output shorted to V_{DD})		50		
DC Power-Supply Rejection		$V_{DD} = 3V \pm 10\%$ or $5V \pm 10\%$			100		$\mu V/V$
DYNAMIC PERFORMANCE							
Voltage-Output Slew Rate	SR	Positive and negative			1.0		V/ μs
Voltage-Output Settling Time		$1/4$ scale to $3/4$ scale, to ≤ 1 LSB, MAX5700			2.2		μs
		$1/4$ scale to $3/4$ scale, to ≤ 1 LSB, MAX5701			2.6		
		$1/4$ scale to $3/4$ scale, to ≤ 1 LSB, MAX5702			4.5		
DAC Glitch Impulse		Major code transition			7		nV*s
Channel-to-Channel Feedthrough (Note 7)		External reference			3.5		nV*s
		Internal reference			3.3		
Digital Feedthrough		Code = 0, all digital inputs from 0V to V_{DDIO}			0.2		nV*s
Power-Up Time		Startup calibration time (Note 8)			200		μs
		From power-down			50		μs

MAX5700/MAX5701/MAX5702

Ultra-Small, Dual-Channel, 8-/10-/12-Bit Buffered Output DACs with Internal Reference and SPI Interface

ELECTRICAL CHARACTERISTICS (continued)

($V_{DD} = 2.7V$ to $5.5V$, $V_{DDIO} = 1.8V$ to $5.5V$, $V_{GND} = 0V$, $C_L = 200pF$, $R_L = 2k\Omega$, $T_A = -40^\circ C$ to $+125^\circ C$, unless otherwise noted. Typical values are at $T_A = +25^\circ C$.) (Note 2)

PARAMETER	SYMBOL	CONDITIONS		MIN	TYP	MAX	UNITS
Output Voltage-Noise Density (DAC Output at Midscale)		External reference	f = 1kHz		90		nV/ \sqrt{Hz}
			f = 10kHz		82		
		2.048V internal reference	f = 1kHz		112		
			f = 10kHz		102		
		2.5V internal reference	f = 1kHz		125		
			f = 10kHz		110		
		4.096V internal reference	f = 1kHz		160		
			f = 10kHz		145		
Integrated Output Noise (DAC Output at Midscale)		External reference	f = 0.1Hz to 10Hz		12		μV_{P-P}
			f = 0.1Hz to 10kHz		76		
			f = 0.1Hz to 300kHz		385		
		2.048V internal reference	f = 0.1Hz to 10Hz		14		
			f = 0.1Hz to 10kHz		91		
			f = 0.1Hz to 300kHz		450		
		2.5V internal reference	f = 0.1Hz to 10Hz		15		
			f = 0.1Hz to 10kHz		99		
			f = 0.1Hz to 300kHz		470		
		4.096V internal reference	f = 0.1Hz to 10Hz		16		
			f = 0.1Hz to 10kHz		124		
			f = 0.1Hz to 300kHz		490		
Output Voltage-Noise Density (DAC Output at Full Scale)		External reference	f = 1kHz		114		nV/ \sqrt{Hz}
			f = 10kHz		99		
		2.048V internal reference	f = 1kHz		175		
			f = 10kHz		153		
		2.5V internal reference	f = 1kHz		200		
			f = 10kHz		174		
		4.096V internal reference	f = 1kHz		295		
			f = 10kHz		255		
Integrated Output Noise (DAC Output at Full Scale)		External reference	f = 0.1Hz to 10Hz		13		μV_{P-P}
			f = 0.1Hz to 10kHz		94		
			f = 0.1Hz to 300kHz		540		
		2.048V internal reference	f = 0.1Hz to 10Hz		19		
			f = 0.1Hz to 10kHz		143		
			f = 0.1Hz to 300kHz		685		
		2.5V internal reference	f = 0.1Hz to 10Hz		21		
			f = 0.1Hz to 10kHz		159		
			f = 0.1Hz to 300kHz		705		
		4.096V internal reference	f = 0.1Hz to 10Hz		26		
			f = 0.1Hz to 10kHz		213		
			f = 0.1Hz to 300kHz		750		

MAX5700/MAX5701/MAX5702

Ultra-Small, Dual-Channel, 8-/10-/12-Bit Buffered Output DACs with Internal Reference and SPI Interface

ELECTRICAL CHARACTERISTICS (continued)

($V_{DD} = 2.7V$ to $5.5V$, $V_{DDIO} = 1.8V$ to $5.5V$, $V_{GND} = 0V$, $C_L = 200pF$, $R_L = 2k\Omega$, $T_A = -40^\circ C$ to $+125^\circ C$, unless otherwise noted. Typical values are at $T_A = +25^\circ C$.) (Note 2)

PARAMETER	SYMBOL	CONDITIONS	MIN	TYP	MAX	UNITS
REFERENCE INPUT						
Reference Input Range	V_{REF}		1.24		V_{DD}	V
Reference Input Current	I_{REF}	$V_{REF} = V_{DD} = 5.5V$		55	74	μA
Reference Input Impedance	R_{REF}		75	100		$k\Omega$
REFERENCE OUTPUT						
Reference Output Voltage	V_{REF}	$V_{REF} = 2.048V$, $T_A = +25^\circ C$	2.043	2.048	2.053	V
		$V_{REF} = 2.5V$, $T_A = +25^\circ C$	2.494	2.500	2.506	
		$V_{REF} = 4.096V$, $T_A = +25^\circ C$	4.086	4.096	4.106	
Reference Output Noise Density		$V_{REF} = 2.048V$	f = 1kHz	129		nV/ \sqrt{Hz}
			f = 10kHz	122		
		$V_{REF} = 2.500V$	f = 1kHz	158		
			f = 10kHz	151		
		$V_{REF} = 4.096V$	f = 1kHz	254		
			f = 10kHz	237		
Integrated Reference Output Noise		$V_{REF} = 2.048V$	f = 0.1Hz to 10Hz	12		μV_{P-P}
			f = 0.1Hz to 10kHz	110		
			f = 0.1Hz to 300kHz	390		
		$V_{REF} = 2.500V$	f = 0.1Hz to 10Hz	15		
			f = 0.1Hz to 10kHz	129		
			f = 0.1Hz to 300kHz	430		
		$V_{REF} = 4.096V$	f = 0.1Hz to 10Hz	20		
			f = 0.1Hz to 10kHz	205		
			f = 0.1Hz to 300kHz	525		
Reference Temperature Coefficient (Note 9)		MAX5702A		± 3	± 10	ppm/ $^\circ C$
		MAX5700/MAX5701/MAX5702B		± 10	± 25	
Reference Drive Capacity		External load		25		$k\Omega$
Reference Capacitive Load				200		pF
Reference Load Regulation		$I_{SOURCE} = 0$ to $500\mu A$		2		mV/mA
Reference Line Regulation				0.05		mV/V
POWER REQUIREMENTS						
Supply Voltage	V_{DD}	$V_{REF} = 4.096V$	4.5		5.5	V
		All other options	2.7		5.5	
I/O Supply Voltage	V_{DDIO}		1.8		5.5	V

MAX5700/MAX5701/MAX5702

Ultra-Small, Dual-Channel, 8-/10-/12-Bit Buffered Output DACs with Internal Reference and SPI Interface

ELECTRICAL CHARACTERISTICS (continued)

($V_{DD} = 2.7V$ to $5.5V$, $V_{DDIO} = 1.8V$ to $5.5V$, $V_{GND} = 0V$, $C_L = 200pF$, $R_L = 2k\Omega$, $T_A = -40^\circ C$ to $+125^\circ C$, unless otherwise noted. Typical values are at $T_A = +25^\circ C$.) (Note 2)

PARAMETER	SYMBOL	CONDITIONS	MIN	TYP	MAX	UNITS
Supply Current (Note 10)	I_{DD}	Internal reference	$V_{REF} = 2.048V$	0.55	0.75	mA
			$V_{REF} = 2.5V$	0.60	0.80	
			$V_{REF} = 4.096V$	0.65	0.90	
		External reference	$V_{REF} = 3V$	0.40	0.60	
			$V_{REF} = 5V$	0.55	0.75	
Interface Supply Current (Note 10)	I_{DDIO}				1	μA
Power-Down Mode Supply Current	I_{PD}	All DACs off, internal reference ON		140		μA
		All DACs off, internal reference OFF, $T_A = -40^\circ C$ to $+85^\circ C$		0.5	1	
		All DACs off, internal reference OFF, $T_A = +125^\circ C$		1.2	2.5	
DIGITAL INPUT CHARACTERISTICS (CSB, SCLK, DIN, \overline{CLR})						
Hysteresis Voltage	V_H			0.15		V
Input High Voltage	V_{IH}	$2.2V < V_{DDIO} < 5.5V$		$0.7 \times V_{DDIO}$		V
		$1.8V < V_{DDIO} < 2.2V$		$0.8 \times V_{DDIO}$		
Input Low Voltage	V_{IL}	$2.2V < V_{DDIO} < 5.5V$			$0.3 \times V_{DDIO}$	V
		$1.8V < V_{DDIO} < 2.2V$			$0.2 \times V_{DDIO}$	
Input Leakage Current	I_{IN}	$V_{IN} = 0V$ or V_{DDIO} (Note 10)		± 0.1	± 1	μA
Input Capacitance (Note 10)	C_{IN}				10	pF
SPI TIMING CHARACTERISTICS (CSB, SCLK, DIN, \overline{CLR}) (Note 11)						
SCLK Frequency	f_{SCLK}	$2.7V < V_{DDIO} < 5.5V$			50	MHz
		$1.8V < V_{DDIO} < 2.7V$			33	
SCLK Period	t_{SCLK}	$2.7V < V_{DDIO} < 5.5V$		20		ns
		$1.8V < V_{DDIO} < 2.7V$		30		
SCLK Pulse Width High	t_{CH}			8		ns
SCLK Pulse Width Low	t_{CL}			8		ns
CSB Fall to SCLK Fall Setup Time	t_{CSS0}	To first SCLK falling edge		8		ns
CSB Fall to SCLK Fall Hold Time	t_{CSH0}	Applies to inactive SCLK falling edge preceding the first SCLK falling edge		0		ns
CSB Rise to SCLK Fall Hold Time	t_{CSH1}	Applies to the 24th SCLK falling edge		0		ns

MAX5700/MAX5701/MAX5702

Ultra-Small, Dual-Channel, 8-/10-/12-Bit Buffered Output DACs with Internal Reference and SPI Interface

ELECTRICAL CHARACTERISTICS (continued)

($V_{DD} = 2.7V$ to $5.5V$, $V_{DDIO} = 1.8V$ to $5.5V$, $V_{GND} = 0V$, $C_L = 200pF$, $R_L = 2k\Omega$, $T_A = -40^\circ C$ to $+125^\circ C$, unless otherwise noted. Typical values are at $T_A = +25^\circ C$.) (Note 2)

PARAMETER	SYMBOL	CONDITIONS	MIN	TYP	MAX	UNITS
CSB Rise to SCLK Fall	t_{CSA}	Applies to the 24th SCLK falling edge, aborted sequence	12			ns
SCLK Fall to CSB Fall	t_{CSF}	Applies to 24th SCLK falling edge	100			ns
CSB Pulse Width High	t_{CSPW}		20			ns
DIN to SCLK Fall Setup Time	t_{DS}		5			ns
DIN to SCLK Fall Hold Time	t_{DH}		4.5			ns
\overline{CLR} Pulse Width Low	t_{CLPW}		20			ns
\overline{CLR} Rise to CSB Fall	t_{CSC}	Required for command to be executed	20			ns

Note 2: Electrical specifications are production tested at $T_A = +25^\circ C$. Specifications over the entire operating temperature range are guaranteed by design and characterization. Typical specifications are at $T_A = +25^\circ C$ and are not guaranteed.

Note 3: DC Performance is tested without load.

Note 4: Linearity is tested with unloaded outputs to within 20mV of GND and V_{DD} .

Note 5: Offset and gain calculated from measurements made with $V_{REF} = V_{DD}$ at code 30 and 4065 for MAX5702, code 8 and 1016 for MAX5701, and code 2 and 254 for MAX5700.

Note 6: Subject to zero and full-scale error limits and V_{REF} settings.

Note 7: Measured with all other DAC outputs at midscale with one channel transitioning 0 to full scale.

Note 8: On power-up, the device initiates an internal 200 μs (typ) calibration sequence. All commands issued during this time will be ignored.

Note 9: Guaranteed by design.

Note 10: All channels active at V_{FS} , unloaded. Static logic inputs with $V_{IL} = V_{GND}$ and $V_{IH} = V_{DDIO}$.

Note 11: All timing tested with $V_{IL} = V_{GND}$ and $V_{IH} = V_{DDIO}$.

MAX5700/MAX5701/MAX5702

Ultra-Small, Dual-Channel, 8-/10-/12-Bit Buffered Output DACs with Internal Reference and SPI Interface

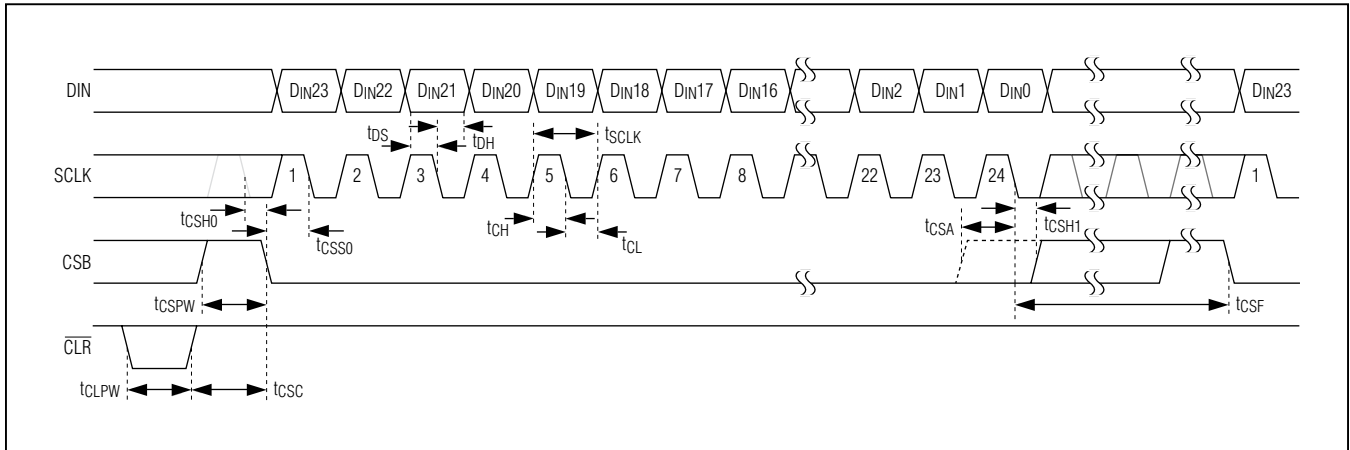
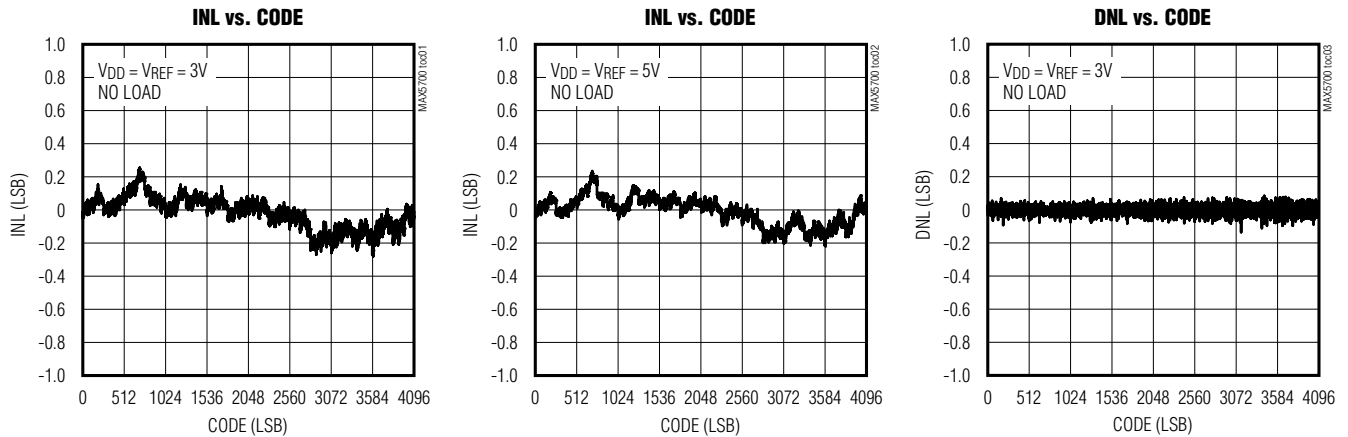

Figure 1. SPI Serial Interface Timing Diagram

Typical Operating Characteristics

(MAX5702, 12-bit performance, T_A = +25°C, unless otherwise noted.)



MAX5700/MAX5701/MAX5702

Ultra-Small, Dual-Channel, 8-/10-/12-Bit Buffered Output DACs with Internal Reference and SPI Interface

Typical Operating Characteristics (continued)

(MAX5702, 12-bit performance, $T_A = +25^\circ\text{C}$, unless otherwise noted.)

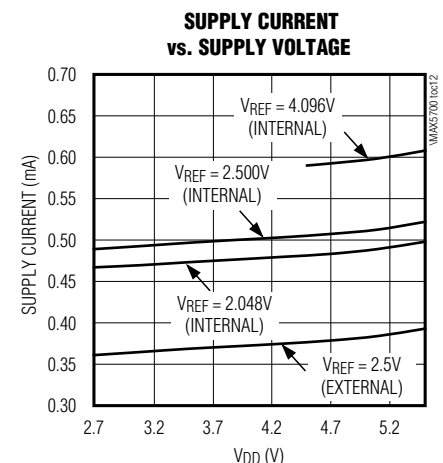
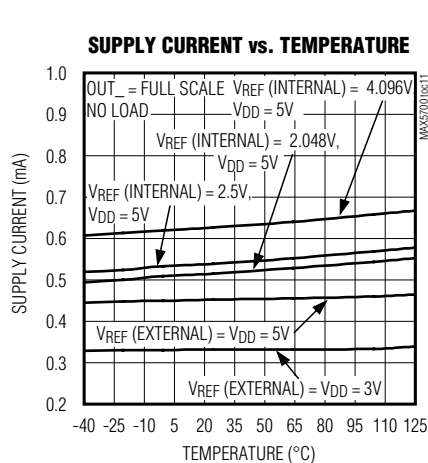
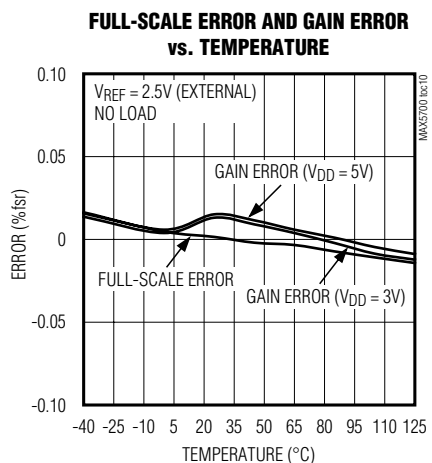
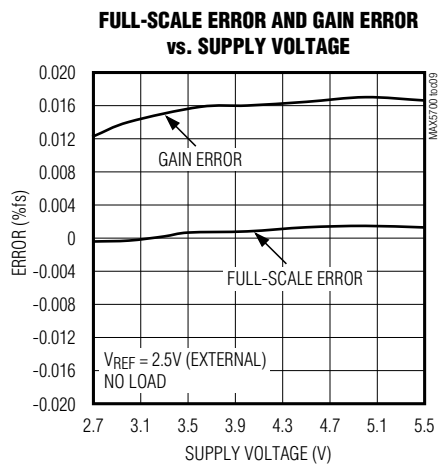
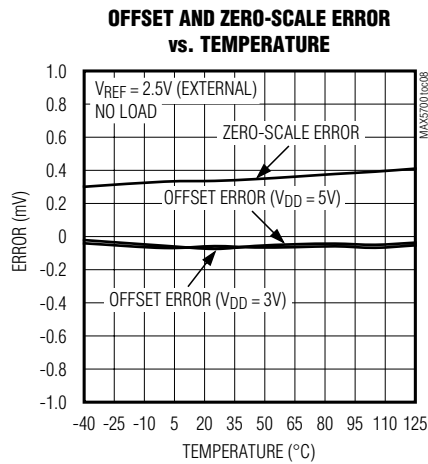
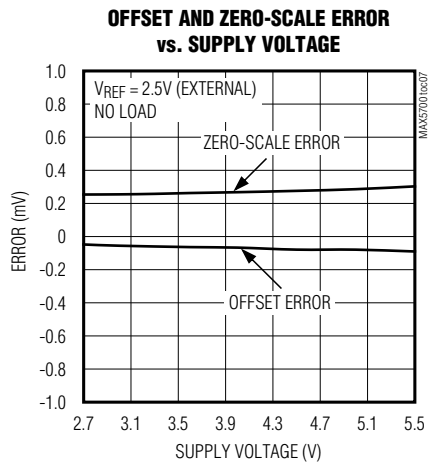
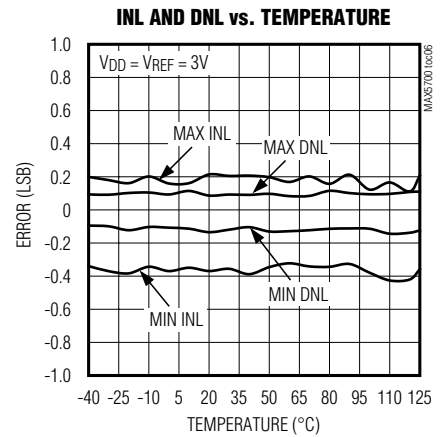
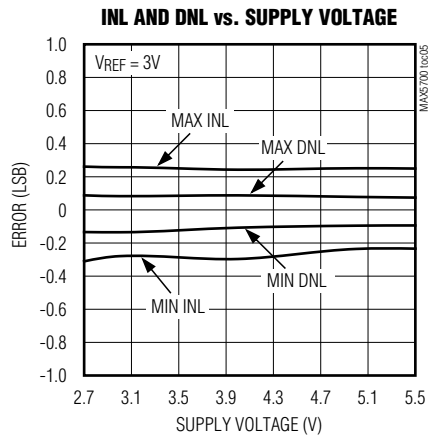
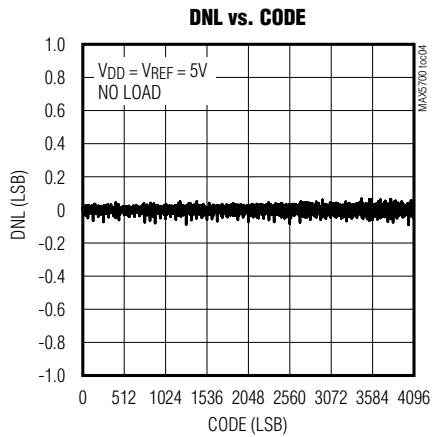

MAX5700/MAX5701/MAX5702

Ultra-Small, Dual-Channel, 8-/10-/12-Bit Buffered Output DACs with Internal Reference and SPI Interface

Typical Operating Characteristics (continued)

(MAX5702, 12-bit performance, $T_A = +25^\circ\text{C}$, unless otherwise noted.)

POWER-DOWN MODE SUPPLY CURRENT vs. TEMPERATURE

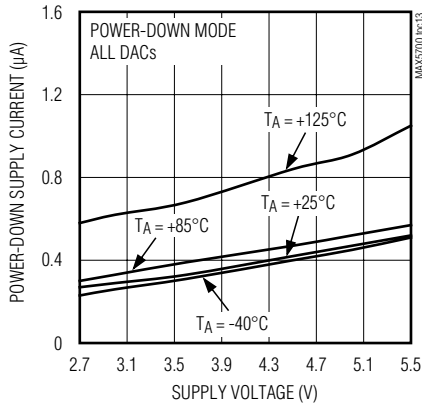

SUPPLY CURRENT vs. CODE

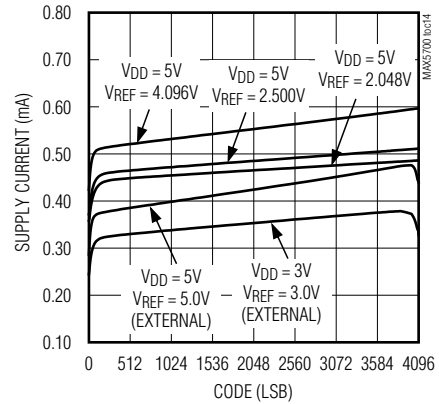

I_{REF} (EXTERNAL) vs. CODE

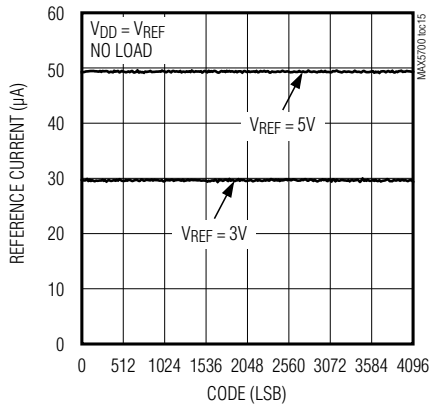

SETTLING TO ± 1 LSB
($V_{DD} = V_{REF} = 5V$, $R_L = 2k\Omega$, $C_L = 200pF$)

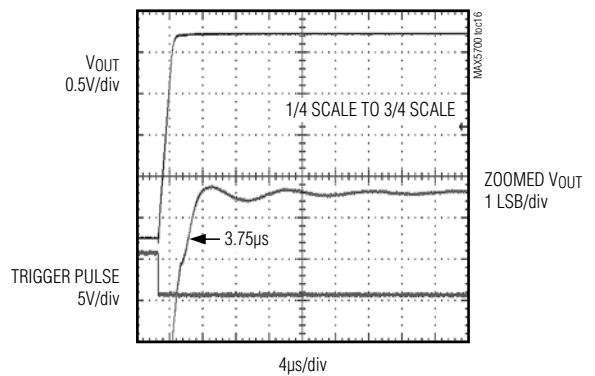

SETTLING TO ± 1 LSB
($V_{DD} = V_{REF} = 5V$, $R_L = 2k\Omega$, $C_L = 200pF$)

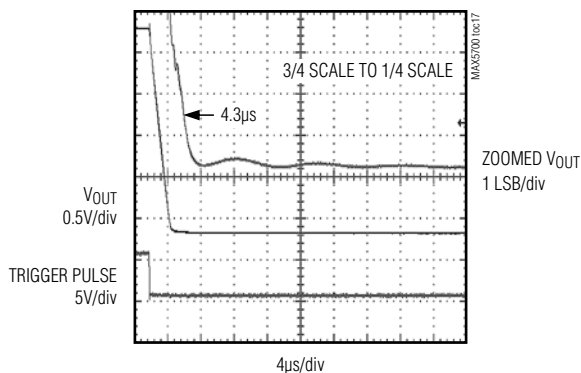

MAJOR CODE TRANSITION GLITCH ENERGY
($V_{DD} = V_{REF} = 5V$, $R_L = 2k\Omega$, $C_L = 200pF$)

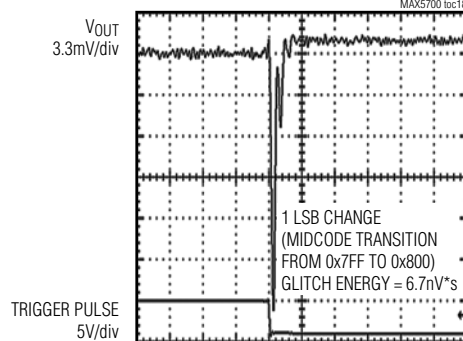

MAX5700/MAX5701/MAX5702

Ultra-Small, Dual-Channel, 8-/10-/12-Bit Buffered Output DACs with Internal Reference and SPI Interface

Typical Operating Characteristics (continued)

(MAX5702, 12-bit performance, $T_A = +25^\circ\text{C}$, unless otherwise noted.)

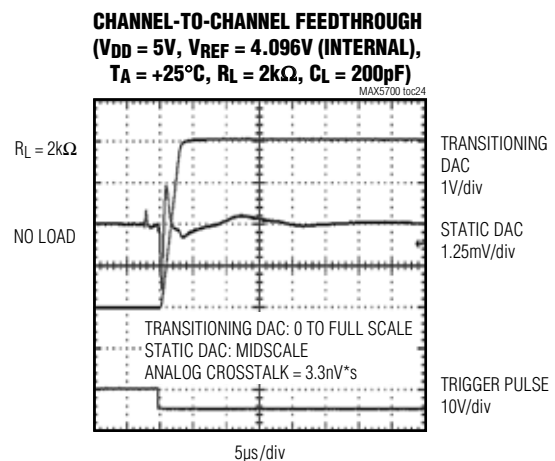
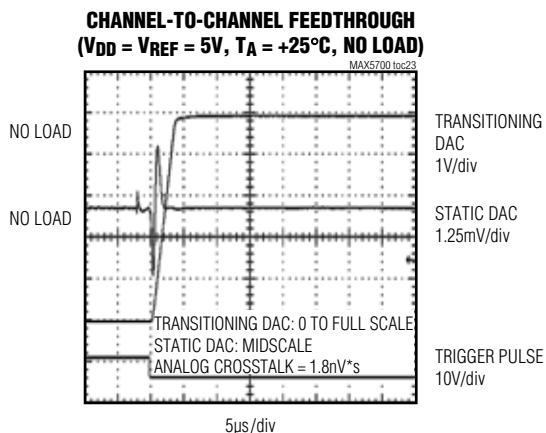
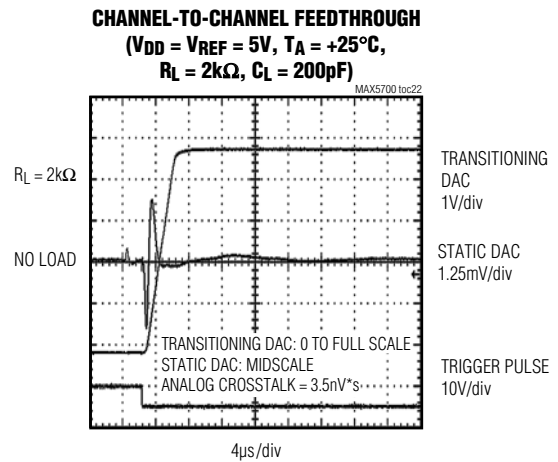
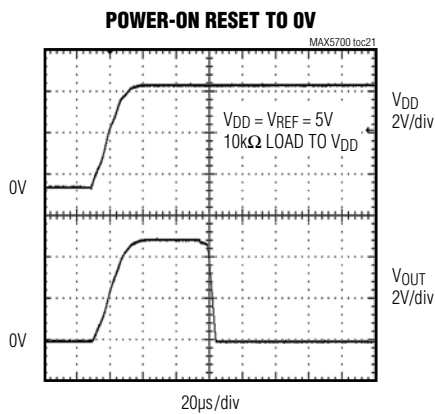
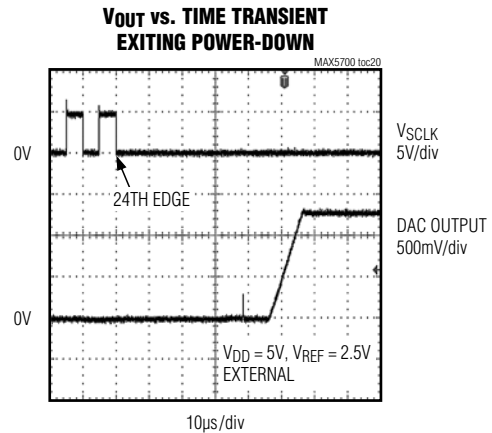
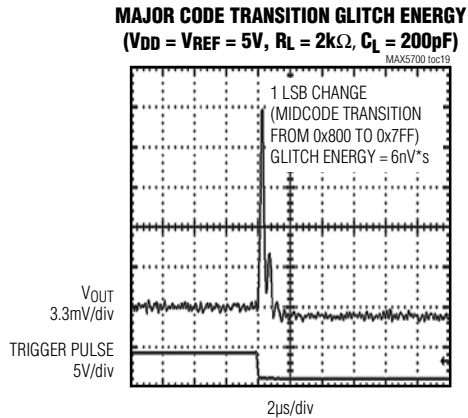

MAX5700/MAX5701/MAX5702

Ultra-Small, Dual-Channel, 8-/10-/12-Bit Buffered Output DACs with Internal Reference and SPI Interface

Typical Operating Characteristics (continued)

(MAX5702, 12-bit performance, $T_A = +25^\circ\text{C}$, unless otherwise noted.)

CHANNEL-TO-CHANNEL FEEDTHROUGH
($V_{DD} = 5\text{V}$, $V_{REF} = 4.096\text{V}$ (INTERNAL),
 $T_A = +25^\circ\text{C}$, NO LOAD)

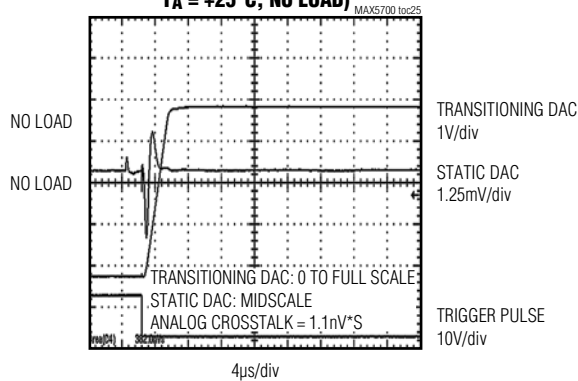

DIGITAL FEEDTHROUGH

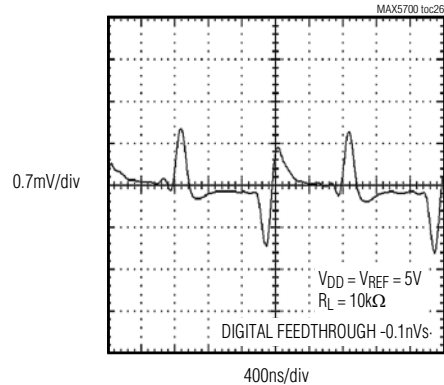

OUTPUT LOAD REGULATION

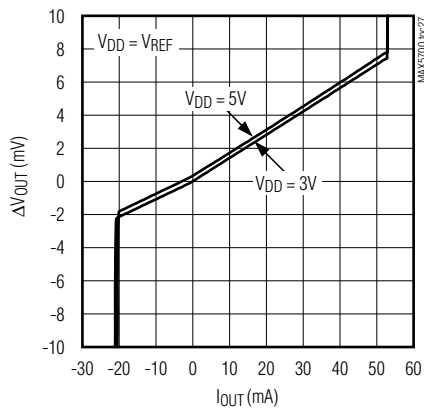

OUTPUT CURRENT LIMITING

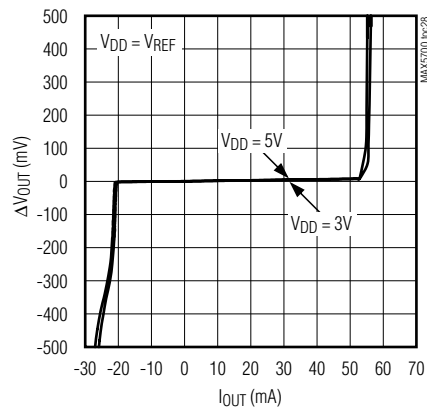

HEADROOM AT RAILS vs. OUTPUT CURRENT

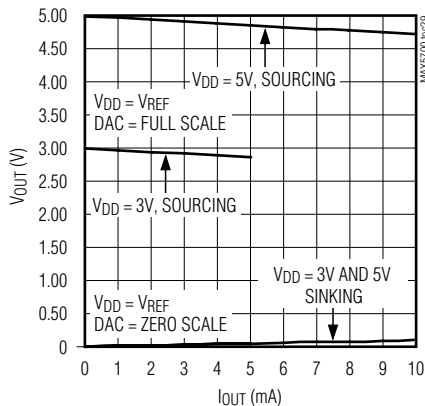

NOISE-VOLTAGE DENSITY vs. FREQUENCY (DAC AT MIDSCALE)

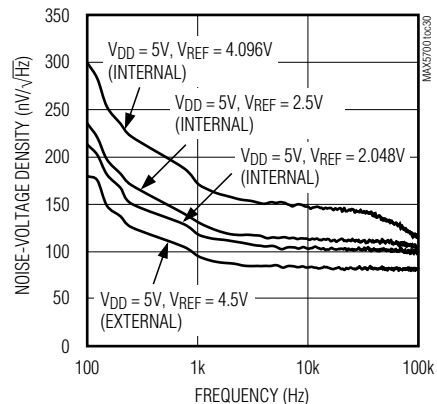

MAX5700/MAX5701/MAX5702

Ultra-Small, Dual-Channel, 8-/10-/12-Bit Buffered Output DACs with Internal Reference and SPI Interface

Typical Operating Characteristics (continued)

(MAX5702, 12-bit performance, $T_A = +25^\circ\text{C}$, unless otherwise noted.)

0.1Hz TO 10Hz OUTPUT NOISE, EXTERNAL REFERENCE ($V_{DD} = 5\text{V}$, $V_{REF} = 4.5\text{V}$)

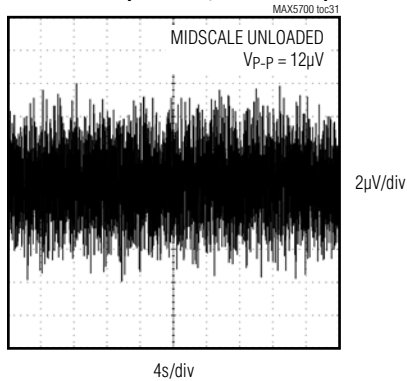

0.1Hz TO 10Hz OUTPUT NOISE, INTERNAL REFERENCE ($V_{DD} = 5\text{V}$, $V_{REF} = 2.048\text{V}$)

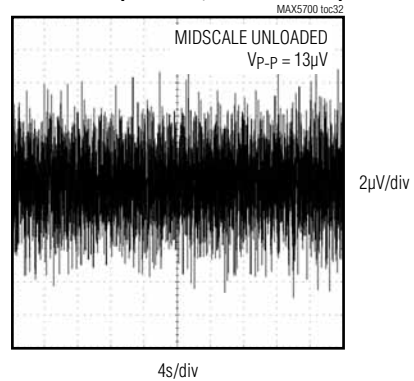

0.1Hz TO 10Hz OUTPUT NOISE, INTERNAL REFERENCE ($V_{DD} = 5\text{V}$, $V_{REF} = 2.5\text{V}$)

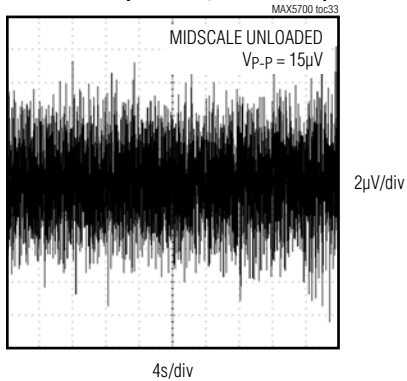

0.1Hz TO 10Hz OUTPUT NOISE, INTERNAL REFERENCE ($V_{DD} = 5\text{V}$, $V_{REF} = 4.096\text{V}$)

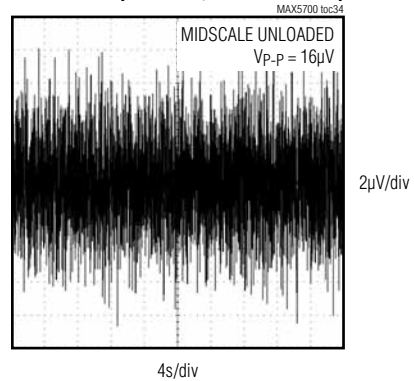

V_{REF} DRIFT vs. TEMPERATURE

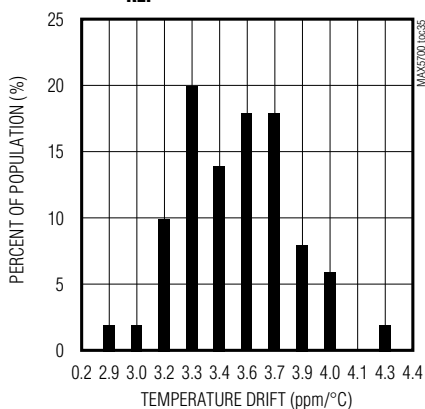

REFERENCE LOAD REGULATION

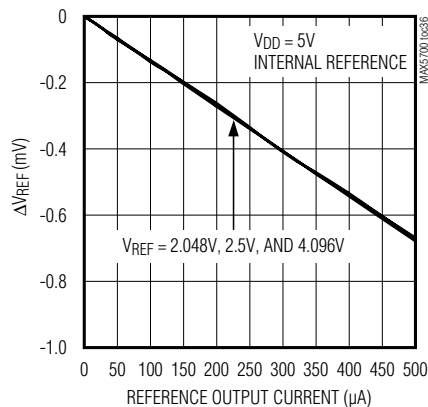

SUPPLY CURRENT vs. LOGIC VOLTAGE

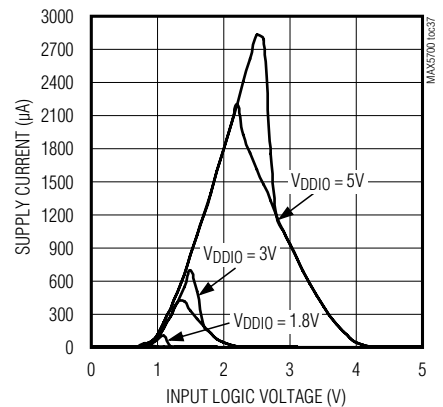

MAX5700/MAX5701/MAX5702

Ultra-Small, Dual-Channel, 8-/10-/12-Bit Buffered Output DACs with Internal Reference and SPI Interface

Pin Configurations

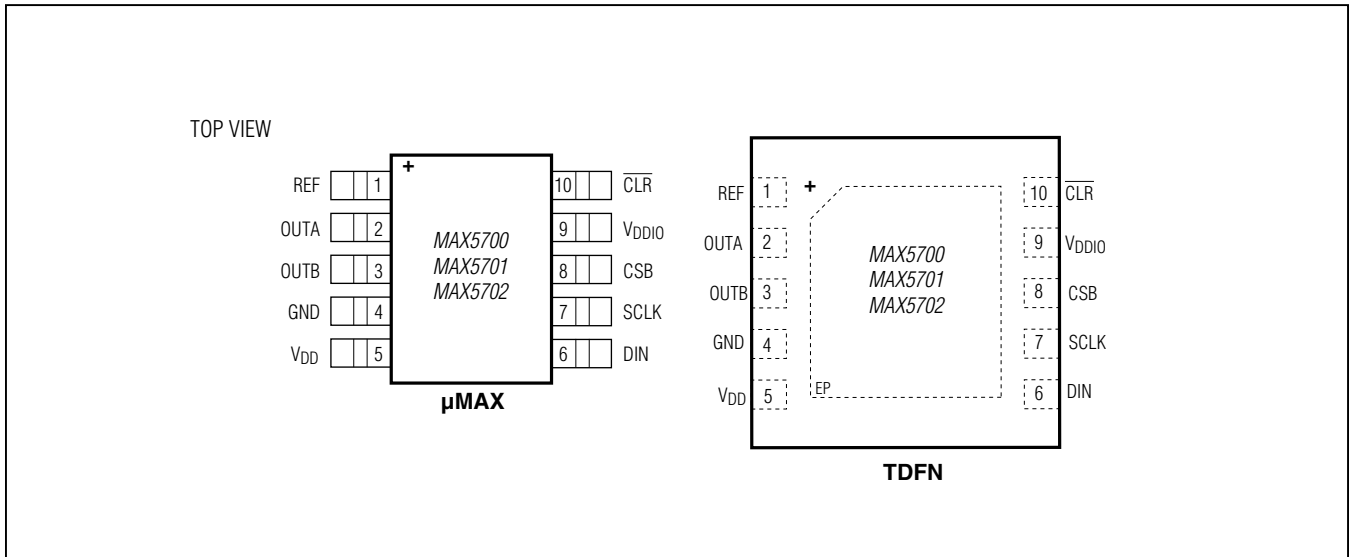

Pin Description

PIN	NAME	FUNCTION
1	REF	Reference Voltage Input/Output
2	OUTA	Buffered Channel A DAC Output
3	OUTB	Buffered Channel B DAC Output
4	GND	Ground
5	V _{DD}	Supply Voltage Input. Bypass V _{DD} with at least a 0.1μF capacitor to GND.
6	DIN	SPI Interface Data Input
7	SCLK	SPI Interface Clock Input
8	CSB	SPI Chip-Select Input
9	V _{DDIO}	Digital Interface Power-Supply Input
10	$\overline{\text{CLR}}$	Active-Low Clear Input
—	EP	Exposed Pad (TDFN Only). Connect to ground.

MAX5700/MAX5701/MAX5702

Ultra-Small, Dual-Channel, 8-/10-/12-Bit Buffered Output DACs with Internal Reference and SPI Interface

Detailed Description

The MAX5700/MAX5701/MAX5702 are 2-channel, low-power, 8-/10-/12-bit buffered voltage-output DACs. The 2.7V to 5.5V wide supply voltage range and low-power consumption accommodates most low-power and low-voltage applications. The devices present a 100kΩ load to the external reference. The internal output buffers allow rail-to-rail operation. An internal voltage reference is available with software selectable options of 2.048V, 2.5V, or 4.096V. The devices feature a 50MHz, 3-wire SPI/QSPI/MICROWIRE/DSP-compatible serial interface to save board space and reduce the complexity in isolated applications. The MAX5700/MAX5701/MAX5702 include a serial-in/parallel-out shift register, internal CODE and DAC registers, a power-on-reset (POR) circuit to initialize the DAC outputs to code zero, and control logic. CLR is available to asynchronously clear the device independent of the serial interface.

DAC Outputs (OUT₋)

The MAX5700/MAX5701/MAX5702 include internal buffers on all DAC outputs. The internal output buffers provide improved load regulation for the DAC outputs. The output buffers slew at 1V/μs (typ) and drive resistive loads as low as 2kΩ in parallel with as much as 500pF of capacitance. The analog supply voltage (V_{DD}) determines the maximum output voltage range of the devices as V_{DD} powers the output buffer. Under no-load conditions, the output buffers drive from GND to V_{DD}, subject to offset and gain errors. With a 2kΩ load to GND, the output buffers drive from GND to within 200mV of V_{DD}. With a 2kΩ load to V_{DD}, the output buffers drive from V_{DD} to within 200mV of GND.

The DAC ideal output voltage is defined by:

$$V_{OUT} = V_{REF} \times \frac{D}{2^N}$$

where D = code loaded into the DAC register, V_{REF} = reference voltage, N = resolution.

Internal Register Structure

The user interface is separated from the DAC logic to minimize digital feedthrough. Within the serial interface is an input shift register, the contents of which can be routed to control registers, individual, or multiple DACs as determined by the user command.

Within each DAC channel there is a CODE register followed by a DAC latch register (see the *Detailed*

Functional Diagram). The contents of the CODE register hold pending DAC output settings which can later be loaded into the DAC registers. The CODE register can be updated using both CODE and CODE_LOAD user commands. The contents of the DAC register hold the current DAC output settings. The DAC register can be updated directly from the serial interface using the CODE_LOAD commands or can upload the current contents of the CODE register using LOAD commands.

The contents of both CODE and DAC registers are maintained during power-down states, so that when the DACs are powered on, they return to their previously stored output settings. Any CODE or LOAD commands issued during power-down states continue to update the register contents. SW_CLEAR and SW_RESET commands reset the contents of all CODE and DAC registers to their zero-scale defaults.

Internal Reference

The MAX5700/MAX5701/MAX5702 include an internal precision voltage reference that is software selectable to be 2.048V, 2.500V, or 4.096V. When an internal reference is selected, that voltage is available on the REF pin for other external circuitry (see the [Typical Operating Circuits](#)) and can drive a 25kΩ load.

External Reference

The external reference input has a typical input impedance of 100kΩ and accepts an input voltage from +1.24V to V_{DD}. Connect an external voltage supply between REF and GND to apply an external reference. The MAX5700/MAX5701/MAX5702 power up and reset to external reference mode. Visit www.maximintegrated.com/products/references for a list of available external voltage-reference devices.

Clear Input (CLR)

The MAX5700/MAX5701/MAX5702 feature an asynchronous active-low CLR logic input that simultaneously sets both DAC outputs to zero. Driving CLR low clears the contents of both the CODE and DAC registers and also aborts the on-going SPI command. To allow a new SPI command, drive CLR high, satisfying the t_{CSC} timing requirement.

Interface Power Supply (V_{DDIO})

The MAX5700/MAX5701/MAX5702 feature a separate supply pin (V_{DDIO}) for the digital interface (1.8V to 5.5V). Connect V_{DDIO} to the I/O supply of the host processor.

MAX5700/MAX5701/MAX5702

Ultra-Small, Dual-Channel, 8-/10-/12-Bit Buffered Output DACs with Internal Reference and SPI Interface

SPI Serial Interface

The MAX5700/MAX5701/MAX5702 3-wire serial interface is compatible with MICROWIRE, SPI, QSPI, and DSPs. The interface provides three inputs, SCLK, CSB, and DIN. The chip-select input (CSB, active low) frames the data loaded through the serial data input (DIN). Following a CSB input high-to-low transition, the data is shifted in synchronously and latched into the input register on each falling edge of the serial clock input (SCLK). Each serial operation word is 24-bits long. The DAC data is left justified as shown in Table 1. The serial input register transfers its contents to the destination registers after loading 24 bits of data on the 24th SCLK falling edge. To initiate a new SPI operation, drive CSB high and then low to begin the next operation sequence, being sure to meet all relevant timing requirements. During CSB high periods, SCLK is ignored, allowing communication to other devices on the same bus. SPI operations consisting of more than 24 SCLK cycles are executed on the 24th SCLK falling edge, using the first three bytes of data available. SPI operations consisting of less than 24 SCLK cycles will not be executed. The content of the SPI operation consists of a command byte followed by a two byte data word.

Figure 1 shows the timing diagram for the complete 3-wire serial interface transmission. The DAC code settings (D) for the MAX5700/MAX5701/MAX5702 are accepted in an offset binary format (see Table 1). Otherwise, the expected data format for each command is listed in Table 2. See Figure 2 for an example of a typical SPI circuit application.

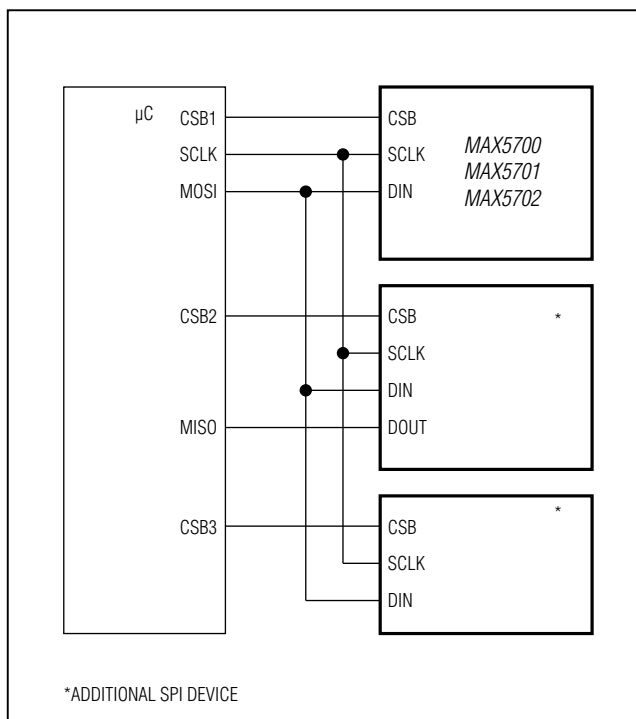

Figure 2. Typical SPI Application Circuit

SPI User-Command Register Map

This section lists the user accessible commands and registers for the MAX5700/MAX5701/MAX5702.

Table 2 provides detailed information about the Command Registers.

Table 1. Format DAC Data Bit Positions

PART	B15	B14	B13	B12	B11	B10	B9	B8	B7	B6	B5	B4	B3	B2	B1	B0
MAX5700	D7	D6	D5	D4	D3	D2	D1	D0	x	x	x	x	x	x	x	x
MAX5701	D9	D8	D7	D6	D5	D4	D3	D2	D1	D0	x	x	x	x	x	x
MAX5702	D11	D10	D9	D8	D7	D6	D5	D4	D3	D2	D1	D0	x	x	x	x

MAX5700/MAX5701/MAX5702

Ultra-Small, Dual-Channel, 8-/10-/12-Bit Buffered Output DACs with Internal Reference and SPI Interface

Table 2. SPI Commands Summary

COMMAND	B23	B22	B21	B20	B19	B18	B17	B16	B15	B14	B13	B12	B11	B10	B9	B8	B7	B6	B5	B4	B3	B2	B1	B0	DESCRIPTION		
DAC COMMANDS																											
CODEn	0	0	0	0	0	0	DAC SELECTION				CODE REGISTER DATA[11:4]							CODE REGISTER DATA[3:0]				X	X	X	X	X	Writes data to the selected CODE register(s)
LOADn	0	0	0	1	0	0	DAC SELECTION		X	X	X	X	X	X	X	X	X	X	X	X	X	X	X	X	Transfers data from the selected CODE register(s) to the selected DAC register(s)		
CODEn_LOAD_ALL	0	0	1	0	0	0	DAC SELECTION				CODE REGISTER DATA[11:4]							CODE REGISTER DATA[3:0]				X	X	X	X	X	Simultaneously writes data to the selected CODE register(s) while updating all DAC registers
CODEn_LOADn	0	0	1	1	0	0	DAC SELECTION				CODE REGISTER DATA[11:4]							CODE REGISTER DATA[3:0]				X	X	X	X	X	Simultaneously writes data to the selected CODE register(s) while updating selected DAC register(s)
CONFIGURATION COMMANDS																											
POWER	0	1	0	0	0	0			X	X	X	X	X	X	X	DACB	DACA	X	X	X	X	X	X	X	X	Sets the power mode of the selected DACs (DACs selected with a 1 in the corresponding DACn bit are updated, DACs with a 0 in the corresponding DACn bit are not impacted)	
SW_CLEAR	0	1	0	1	0	0	0	0	0	X	X	X	X	X	X	X	X	X	X	X	X	X	X	X	X	Executes a software clear (all CODE and DAC registers cleared to their default values)	
SW_RESET	0	1	0	1	0	0	0	1	0	X	X	X	X	X	X	X	X	X	X	X	X	X	X	X	X	Executes a software reset (all CODE, DAC, and control registers returned to their default values)	

MAX5700/MAX5701/MAX5702

Ultra-Small, Dual-Channel, 8-/10-/12-Bit Buffered Output DACs with Internal Reference and SPI Interface

Table 2. SPI Commands Summary (continued)

COMMAND	B23	B22	B21	B20	B19	B18	B17	B16	B15	B14	B13	B12	B11	B10	B9	B8	B7	B6	B5	B4	B3	B2	B1	B0	DESCRIPTION
CONFIG	0	1	1	0	0	0	0	LD_EN	X	X	X	X	X	X	DAC B	DAC A	X	X	X	X	X	X	X	X	Sets the DAC Latch Mode of the selected DACs. Only DACs with a 1 in the selection bit are updated by the command. LD_EN = 0: DAC latch is operational (LOAD controlled) LD_EN = 1: DAC latch is transparent
REF	0	1	1	1	0	0	0	REF Mode 00 = EXT 01 = 2.5V 10 = 2.0V 11 = 4.1V	X	X	X	X	X	X	X	X	X	X	X	X	X	X	X	X	Sets the reference operating mode. REF Power (B18): 0 = Internal reference is only powered if at least one DAC is powered 1 = Internal reference is always powered
ALL DAC COMMANDS																									
CODE_ALL	1	0	0	0	0	0	0	0	CODE REGISTER DATA[11:4]				CODE REGISTER DATA[3:0]				Writes data to all CODE registers								
LOAD_ALL	1	0	0	0	0	0	1	0	X	X	X	X	X	X	X	X	X	X	X	X	X	X	X	X	Updates all DAC latches with current CODE register data
CODE_ALL_LOAD_ALL	1	0	0	0	0	0	1	X	CODE REGISTER DATA[11:4]				CODE REGISTER DATA[3:0]				Simultaneously writes data to all CODE registers while updating all DAC registers								
NO OPERATION COMMANDS																									
No Operation	1	0	0	1	X	X	X	X	X	X	X	X	X	X	X	X	X	X	X	X	X	X	X	X	These commands will have no effect on the device
Reserved Commands: Any commands not specifically listed above are reserved for Maxim internal use only.																									

MAX5700/MAX5701/MAX5702

Ultra-Small, Dual-Channel, 8-/10-/12-Bit Buffered Output DACs with Internal Reference and SPI Interface

CODEn Command

The CODEn command (B[23:20] = 0000) updates the CODE register contents for the selected DAC(s). Changes to the CODE register content based on this command will not affect DAC outputs directly unless the DAC latch has been configured to be transparent. Issuing the CODEn command with DAC SELECTION = ALL DACs is equivalent to CODE_ALL (B[23:16] = 10000000). See [Table 2](#) and [Table 3](#).

LOADn Command

The LOADn command (B[23:20] = 0001) updates the DAC register content for the selected DAC(s) by uploading the current contents of the CODE register. The LOADn command can be used with DAC SELECTION = ALL DACs to issue a software load for all DACs, which is equivalent to the LOAD_ALL (B[23:16] = 10000001) command. See [Table 2](#) and [Table 3](#).

CODEn_LOAD_ALL Command

The CODEn_LOAD_ALL command (B[23:20] = 0010) updates the CODE register contents for the selected DAC(s) as well as the DAC register content of all DACs. Channels for which the CODE register content has not been modified since the last load to DAC register operation will not be updated to reduce digital crosstalk. Issuing this command with DAC_ADDRESS = ALL is equivalent to the CODE_ALL_LOAD_ALL (B[23:16] = 1000001x) command. The CODEn_LOAD_ALL command by definition will modify at least one CODE register. To avoid this, use

the LOADn command with DAC SELECTION = ALL DACs or use the LOAD_ALL command. See [Table 2](#) and [Table 3](#).

CODEn_LOADn Command

The CODEn_LOADn command (B[23:20] = 0011) updates the CODE register contents for the selected DAC(s) as well as the DAC register content of the selected DAC(s). Channels for which the CODE register content has not been modified since the last load to DAC register operation will not be updated to reduce digital crosstalk. Issuing this command with DAC SELECTION = ALL DACs is equivalent to the CODE_ALL_LOAD_ALL command. See [Table 2](#) and [Table 3](#).

CODE_ALL Command

The CODE_ALL command (B[23:16] = 10000000) updates the CODE register contents for all DACs. See [Table 2](#).

LOAD_ALL Command

The LOAD_ALL command (B[23:16] = 10000001) updates the DAC register content for all DACs by uploading the current contents of the CODE registers. See [Table 2](#).

CODE_ALL_LOAD_ALL Command

The CODE_ALL_LOAD_ALL command (B[23:16] = 1000001x) updates the CODE register contents for all DACs as well as the DAC register content of all DACs. See [Table 2](#).

Table 3. DAC Selection

B19	B18	B17	B16	DAC SELECTED
0	0	0	0	DAC A
0	0	0	1	DAC B
0	0	1	X	No effect
X	1	X	X	ALL DACs
1	X	X	X	ALL DACs

MAX5700/MAX5701/MAX5702

Ultra-Small, Dual-Channel, 8-/10-/12-Bit Buffered Output DACs with Internal Reference and SPI Interface

POWER Command

The MAX5700/MAX5701/MAX5702 feature a software-controlled power-mode (POWER) command (B[23:18] = 010000). The POWER command updates the power-mode settings of the selected DACs while the power settings of the rest of the DACs remain unchanged. The new power setting is determined by bits B[17:16] while the affected DAC(s) are selected by bits B[9:8]. If all DACs are powered down, the device enters a STANDBY mode.

In power-down, the DAC output is disconnected from the buffer and is grounded with either one of the two selectable internal resistors or set to high impedance. See [Table 5](#) for the selectable internal resistor values in power-down mode. In power-down mode, the DAC register retains its value so that the output is restored when the device powers up. The serial interface remains active in power-down mode.

In STANDBY mode, the internal reference can be powered down or it can be set to remain powered-on for external use. Also, in STANDBY mode, devices using the external reference do not load the REF pin. See [Table 4](#).

SW_RESET and SW_CLEAR Command

The SW_RESET (B[23:16] = 01010001) and SW_CLEAR (B[23:16] = 01010000) commands provide a means of issuing a software reset or software clear operation. Use SW_CLEAR to issue a software clear operation to return all CODE and DAC registers to the zero-scale value. Use SW_RESET to reset all CODE, DAC, and configuration registers to their default values.

Table 4. POWER Command Format

B23	B22	B21	B20	B19	B18	B17	B16	B15	B14	B13	B12	B11	B10	B9	B8	B7	B6	B5	B4	B3	B2	B1	B0		
0	1	0	0	0	0	PD1	PD0	X	X	X	X	X	X	B	A	X	X	X	X	X	X	X	X		
POWER Command							Power Mode: 00 = Normal 01 = 1kΩ 10 = 100kΩ 11 = Hi-Z	Don't Care						Multiple DAC Selection: 1 = DAC Selected 0 = DAC Not Selected	Don't Care										
Default Values (all DACs)							0	0	X	X	X	X	X	X	1	1	X	X	X	X	X	X	X	X	X

Table 5. Selectable DAC Output Impedance in Power-Down Mode

PD1 (B17)	PD0 (B16)	OPERATING MODE
0	0	Normal operation
0	1	Power-down with internal 1kΩ pulldown resistor to GND.
1	0	Power-down with internal 100kΩ pulldown resistor to GND.
1	1	Power-down with high-impedance output.

MAX5700/MAX5701/MAX5702

Ultra-Small, Dual-Channel, 8-/10-/12-Bit Buffered Output DACs with Internal Reference and SPI Interface

CONFIG Command

The CONFIG command (B[23:17] = 0110000) updates the LOAD functions of selected DACs. Issue the command with B16 = 0 to allow the DAC latches to operate normally or with B16 = 1 to disable the DAC latches, making them perpetually transparent. Mode settings of the selected DACs are updated while the mode settings of the rest of the DACs remain unchanged; DAC(s) are selected by bits B[9:8]. See [Table 6](#).

REF Command

The REF command updates the global reference setting used for all DAC channels. Set B[17:16] = 00 to use an external reference for the DACs or set B[17:16] to 01, 10, or 11 to select either the 2.5V, 2.048V, or 4.096V internal reference, respectively.

If RF2 (B18) is set to zero (default) in the REF command, the reference will be powered down any time all DAC channels are powered down (in STANDBY mode). If RF2 (B18 = 1) is set to one, the reference will remain powered even if all DAC channels are powered down, allowing continued operation of external circuitry. In this mode, the 1µA shutdown state is not available. See [Table 7](#).

Table 6. CONFIG Command Format

B23	B22	B21	B20	B19	B18	B17	B16	B15	B14	B13	B12	B11	B10	B9	B8	B7	B6	B5	B4	B3	B2	B1	B0		
0	1	1	0	0	0	0	LDB	X	X	X	X	X	X	B	A	X	X	X	X	X	X	X	X		
CONFIG Command							0 = Normal 1 = Transparent	Don't Care						Multiple DAC Selection: 1 = DAC Selected 0 = DAC Not Selected	Don't Care										
Default Values (all DACs)							0	X	X	X	X	X	X	1	1	X	X	X	X	X	X	X	X	X	X

Table 7. REF Command Format

B23	B22	B21	B20	B19	B18	B17	B16	B15	B14	B13	B12	B11	B10	B9	B8	B7	B6	B5	B4	B3	B2	B1	B0
0	1	1	1	0	RF2	RF1	RF0	X	X	X	X	X	X	X	X	X	X	X	X	X	X	X	X
REF Command					0 = Off in Standby 1 = On in Standby	REF Mode: 00 = EXT 01 = 2.5V 10 = 2.0V 11 = 4.0V		Don't Care						Don't Care									
Default Values					0	0	0	X	X	X	X	X	X	X	X	X	X	X	X	X	X	X	X

MAX5700/MAX5701/MAX5702

Ultra-Small, Dual-Channel, 8-/10-/12-Bit Buffered Output DACs with Internal Reference and SPI Interface

Applications Information

Power-On Reset (POR)

When power is applied to V_{DD} and V_{DDIO} , the DAC output is set to zero scale. To optimize DAC linearity, wait until the supplies have settled and the internal setup and calibration sequence completes (200 μ s, typ).

Power Supplies and Bypassing Considerations

Bypass V_{DD} and V_{DDIO} with high-quality ceramic capacitors to a low-impedance ground as close as possible to the device. Minimize lead lengths to reduce lead inductance. Connect the GND to the analog ground plane.

Layout Considerations

Digital and AC transient signals on GND can create noise at the output. Connect GND to form the star ground for the DAC system. Refer remote DAC loads to this system ground for the best possible performance. Use proper grounding techniques, such as a multilayer board with a low-inductance ground plane, or star connect all ground return paths back to the MAX5700/MAX5701/MAX5702 GND. Carefully layout the traces between channels to reduce AC cross-coupling. Do not use wire-wrapped boards and sockets. Use shielding to minimize noise immunity. Do not run analog and digital signals parallel to one another, especially clock signals. Avoid routing digital lines underneath the MAX5700/MAX5701/MAX5702 package.

Definitions

Integral Nonlinearity (INL)

INL is the deviation of the measured transfer function from a straight line drawn between two codes once offset and gain errors have been nullified.

Differential Nonlinearity (DNL)

DNL is the difference between an actual step height and the ideal value of 1 LSB. If the magnitude of the DNL \leq 1 LSB, the DAC guarantees no missing codes and is monotonic. If the magnitude of the DNL \geq 1 LSB, the DAC output may still be monotonic.

Offset Error

Offset error indicates how well the actual transfer function matches the ideal transfer function. The offset error is calculated from two measurements near zero code and near maximum code.

Gain Error

Gain error is the difference between the ideal and the actual full-scale output voltage on the transfer curve, after nullifying the offset error. This error alters the slope of the transfer function and corresponds to the same percentage error in each step.

Zero-Scale Error

Zero-scale error is the difference between the DAC output voltage when set to code zero and ground. This includes offset and other die level nonidealities.

Full-Scale Error

Full-scale error is the difference between the DAC output voltage when set to full scale and the reference voltage. This includes offset, gain error, and other die level nonidealities.

Settling Time

The settling time is the amount of time required from the start of a transition, until the DAC output settles to the new output value within the converter's specified accuracy.

Digital Feedthrough

Digital feedthrough is the amount of noise that appears on the DAC output when the DAC digital control lines are toggled.

Digital-to-Analog Glitch Impulse

A major carry transition occurs at the midscale point where the MSB changes from low to high and all other bits change from high to low, or where the MSB changes from high to low and all other bits change from low to high. The duration of the magnitude of the switching glitch during a major carry transition is referred to as the digital-to-analog glitch impulse.

The digital-to-analog power-up glitch is the duration of the magnitude of the switching glitch that occurs as the device exits power-down mode.

MAX5700/MAX5701/MAX5702

Ultra-Small, Dual-Channel, 8-/10-/12-Bit Buffered Output DACs with Internal Reference and SPI Interface

Detailed Functional Diagram

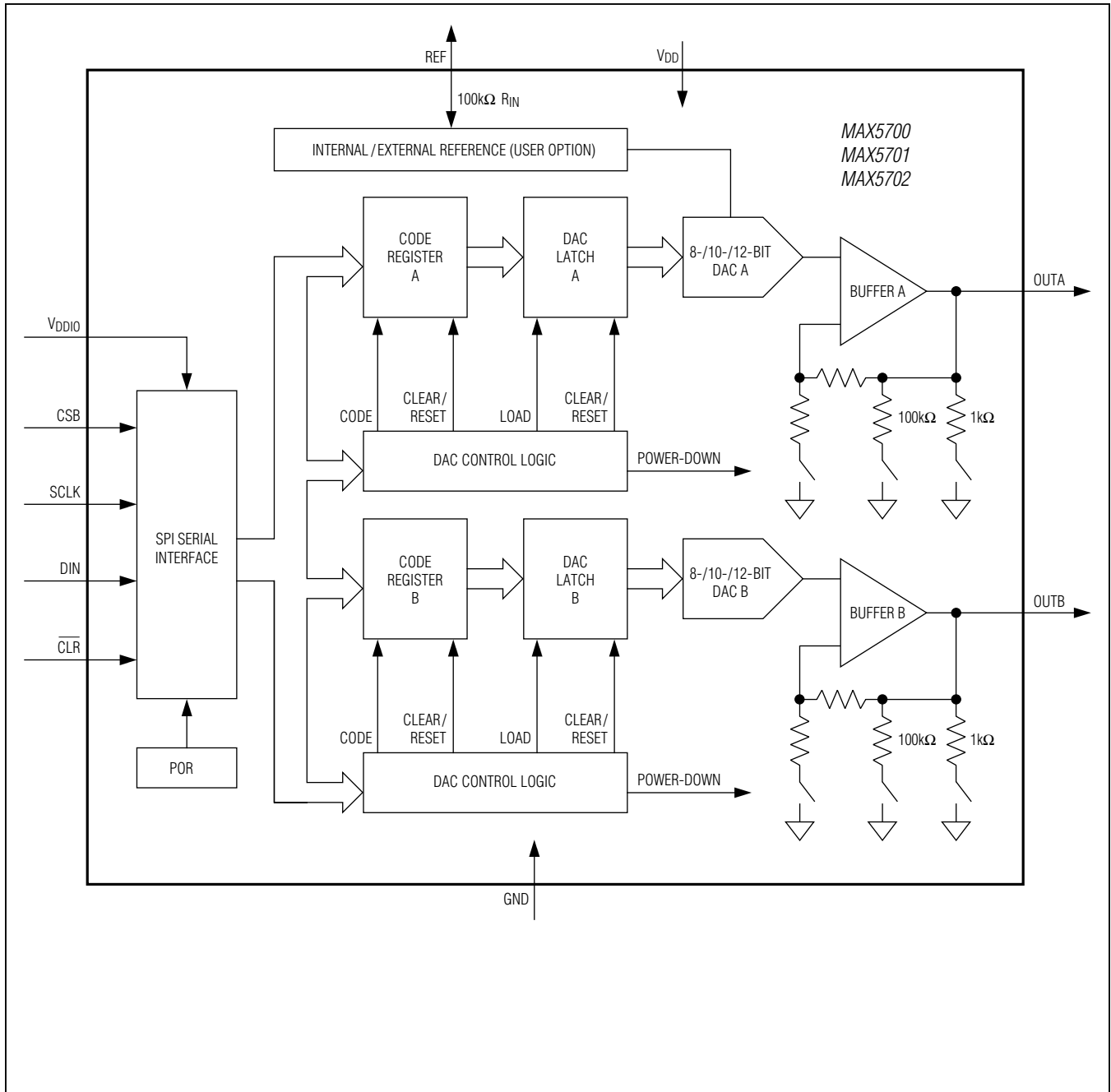

MAX5700/MAX5701/MAX5702

Ultra-Small, Dual-Channel, 8-/10-/12-Bit Buffered Output DACs with Internal Reference and SPI Interface

Typical Operating Circuits

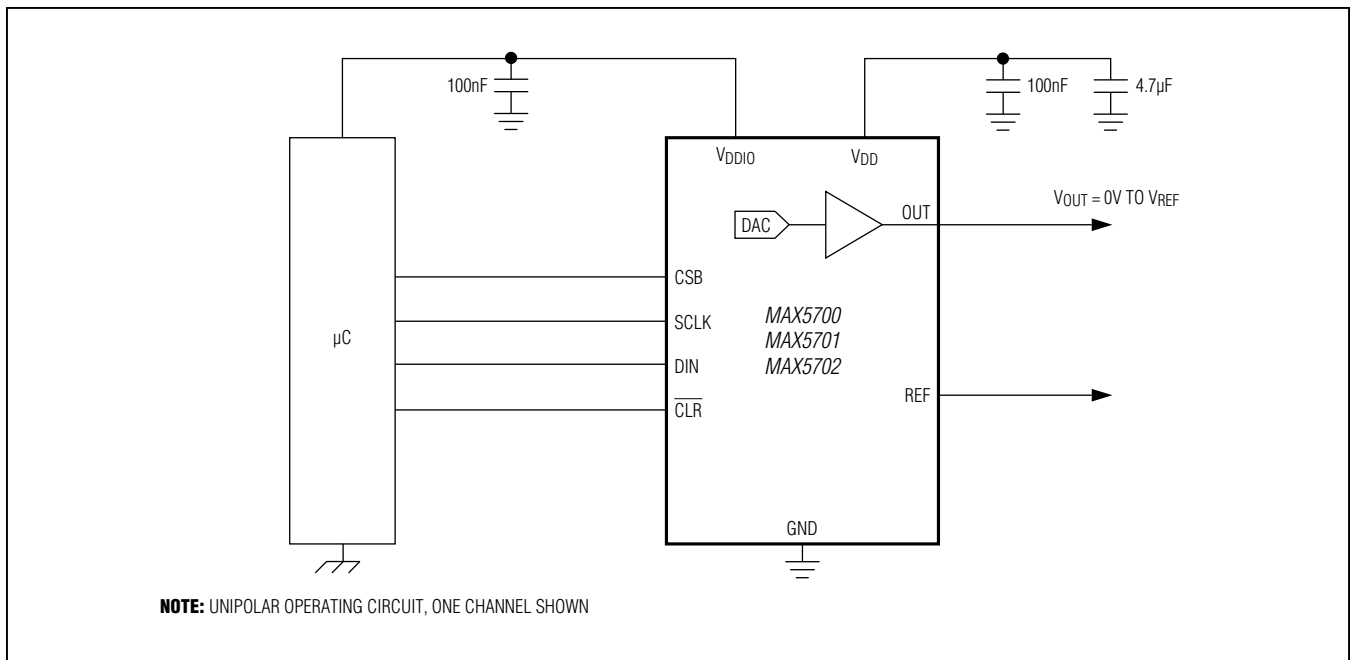
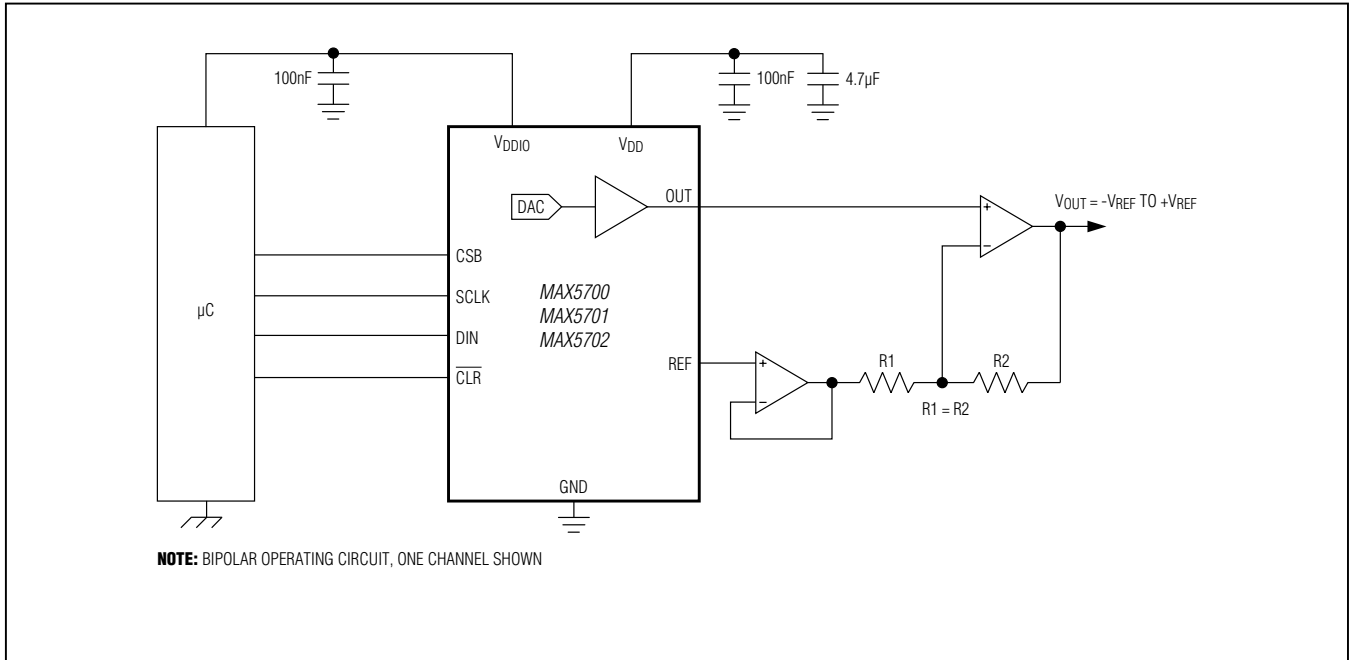

MAX5700/MAX5701/MAX5702

Ultra-Small, Dual-Channel, 8-/10-/12-Bit Buffered Output DACs with Internal Reference and SPI Interface

Ordering Information

PART	PIN-PACKAGE	RESOLUTION (BIT)	INTERNAL REFERENCE TEMPCO (ppm/°C)
MAX5700 ATB+T*	10 TDFN-EP**	8	10 (typ), 25 (max)
MAX5700AUB+*	10 μ MAX	8	10 (typ), 25 (max)
MAX5701 ATB+T*	10 TDFN-EP**	10	10 (typ), 25 (max)
MAX5701AUB+*	10 μ MAX	10	10 (typ), 25 (max)
MAX5702 AAUB+	10 μ MAX	12	3 (typ), 10 (max)
MAX5702BATB+T*	10 TDFN-EP**	12	10 (typ), 25 (max)
MAX5702BAUB+*	10 μ MAX	12	10 (typ), 25 (max)

Note: All devices are specified over the -40°C to +125°C temperature range.

+Denotes a lead(Pb)-free/RoHS-compliant package.

T = Tape and reel.

*Future product—Contact factory for availability.

**EP = Exposed pad.

Chip Information

PROCESS: BiCMOS

Package Information

For the latest package outline information and land patterns (footprints), go to www.maximintegrated.com/packages. Note that a "+", "#", or "-" in the package code indicates RoHS status only. Package drawings may show a different suffix character, but the drawing pertains to the package regardless of RoHS status.

PACKAGE TYPE	PACKAGE CODE	OUTLINE NO.	LAND PATTERN NO.
10 μ MAX	U10+2	21-0061	90-0330
10 TDFN-EP	T1033+1	21-0137	90-0003

MAX5700/MAX5701/MAX5702

Ultra-Small, Dual-Channel, 8-/10-/12-Bit Buffered Output DACs with Internal Reference and SPI Interface

Revision History

REVISION NUMBER	REVISION DATE	DESCRIPTION	PAGES CHANGED
0	9/12	Initial release	—
1	12/12	Updated <i>Electrical Characteristics</i> and <i>Ordering Information</i>	7, 25



Maxim Integrated cannot assume responsibility for use of any circuitry other than circuitry entirely embodied in a Maxim Integrated product. No circuit patent licenses are implied. Maxim Integrated reserves the right to change the circuitry and specifications without notice at any time. The parametric values (min and max limits) shown in the Electrical Characteristics table are guaranteed. Other parametric values quoted in this data sheet are provided for guidance.

Maxim Integrated 160 Rio Robles, San Jose, CA 95134 USA 1-408-601-1000

26

Данный компонент на территории Российской Федерации

Вы можете приобрести в компании MosChip.

Для оперативного оформления запроса Вам необходимо перейти по данной ссылке:

<http://moschip.ru/get-element>

Вы можете разместить у нас заказ для любого Вашего проекта, будь то серийное производство или разработка единичного прибора.

В нашем ассортименте представлены ведущие мировые производители активных и пассивных электронных компонентов.

Нашей специализацией является поставка электронной компонентной базы двойного назначения, продукции таких производителей как XILINX, Intel (ex.ALTERA), Vicor, Microchip, Texas Instruments, Analog Devices, Mini-Circuits, Amphenol, Glenair.

Сотрудничество с глобальными дистрибьюторами электронных компонентов, предоставляет возможность заказывать и получать с международных складов практически любой перечень компонентов в оптимальные для Вас сроки.

На всех этапах разработки и производства наши партнеры могут получить квалифицированную поддержку опытных инженеров.

Система менеджмента качества компании отвечает требованиям в соответствии с ГОСТ Р ИСО 9001, ГОСТ РВ 0015-002 и ЭС РД 009

Офис по работе с юридическими лицами:

105318, г.Москва, ул.Щербаковская д.3, офис 1107, 1118, ДЦ «Щербаковский»

Телефон: +7 495 668-12-70 (многоканальный)

Факс: +7 495 668-12-70 (доб.304)

E-mail: info@moschip.ru

Skype отдела продаж:

moschip.ru

moschip.ru_4

moschip.ru_6

moschip.ru_9