

CNS650-M Series

650 Watt AC-DC Power Supplies

Data Sheet

Total Power: 650 Watts
Input Voltage: 90 - 264 V
of Outputs: Single



SPECIAL FEATURES

- Designed for forced air and natural convection cooling
- Medical and ITE safety approvals, 2x MOPP
- PMBus® interface
- Active current share with OR-ing FET
- Dual fused
- Type BF ready
- Active Power Factor Correction, 61000-3-2 compliant
- Built-in Class B EMI filter
- Less than 1U high
- 4" x 6" U-channel construction (open-frame or end-fan variants available for 12 V)
- <500 mW no-load power consumption
- 80 PLUS® certified (-ME model)
- Three-year warranty (consult factory for extended terms)

Electrical Specifications

Input	
Input voltage range	90 - 264 Vac; 127 - 350 Vdc
Frequency	47 - 63 Hz (360 - 440 Hz with higher leakage)
Inrush current	50 Apk, cold start
Leakage current	<300 µA (using UL test method)
No load power	< 500 mW
Output	
Maximum power	650 W, forced-air cooling (750 W peak) 400 W, free-air natural convection cooling (650 W peak)
Adjustment range	-0% / +15%
Holdup time	20 ms @ 400 W
Fan output	12 V @ 1.0 A (forced air) 12 V @ 0.5 A (natural convection)
Standby output	5 V @ 2.0 A (forced air) 5 V @ 1.0 A (natural convection)

SAFETY

- UL/CSA ES60601-1/C22.2
No. 60601-1
UL/CSA 62368-1
- TÜV EN 60601-1
- DEMKO EN 62368-1
- CB IEC 60950-1
IEC 60601-1
IEC 62368-1
- CCC GB4943.1/GB9254;
GB17625.1
- CE LVD, RoHS

** CNS650-M tested according to the medical standard IEC 60601-1-2 4th Edition.

Electrical Specifications (continued)

Control and Protection	
Serial bus interface	PMBus®
Current share	Active
Remote sense	2-wire (+ and -)
Remote inhibit	Pull inhibit low = main & fan output OFF (5 V standby is ON) Pull inhibit high (or floating) = all outputs ON
AC OK	Active high when normal AC input is present (with internal 10k ohm pull up to 3.3 Vdc)
DC OK	Active high when main O/P is within regulation (with internal 10k ohm pull up to 3.3 Vdc)
Smart fan control	Monitor, control and override
Overvoltage protection	Latching / AC recyle or inhibit toggle required for PSU restart
Overload protection	Auto-recovery (Constant current mode down to 50% Vout)
Overtemperature protection	Auto-recovery with hysteresis

Environmental Specifications

Operating temperature	-20 °C to +80 °C (derate at 50 °C), startup at -40 °C
Storage temperature	-40 °C to +85 °C
Operating humidity	5% to 95% (non-condensing)
Non-operating humidity	5% to 95% (non-condensing)
Maximum altitude	5000 m (3000 m for medical), derating may apply

Other Specifications

Isolation	4000 Vac (input to output) 1500 Vac (input to PE; output to PE)
Line harmonics	61000-3-2, Class A
ESD immunity	61000-4-2; ±15kV (air)/±8kV (contact); Criterion A
Conducted EMI	Level B, CISPR 22 and FCC Part 15
Radiated EMI	Level B, CISPR 22 and FCC Part 15 (with cover)
Surge immunity	61000-4-5, Level 3 - Criterion A; Level 4 - Criterion C
Medical EMC	60601-1-2, Edition 4 (cover maybe required for some tests)
MTBF (Telcordia, Issue 3, Method 1, Case 3)	> 950 KHrs, 25 °C, 410 W natural convection > 1.3 MHrs, 25 °C, 650 W forced air

Ordering Information

Model Number	Output Voltage	Vout Adjust Range (-0% / +15%)	Minimum Load	Max. Continuous Load (Free Air)	Max. Peak Load (Free Air) ¹	Max. Continuous Load (Forced Air) ²	Max. Peak Load (Forced Air) ²	Regulation ³	Ripple (p-p) ⁴
CNS653-ME ^{5,6}	12 V	12 - 13.8 V	0 A	54.2 A	62.5 A	NA	NA	±2%	120 mV
CNS653-MF ⁵	12 V	12 - 13.8 V	0 A	30.8 A	54.2 A	54.2 A	62.5 A	±2%	120 mV
CNS653-MU	12 V	12 - 13.8 V	0 A	33.3 A	54.2 A	54.2 A	62.5 A	±2%	120 mV
CNS655-MU	24 V	24 - 27.6 V	0 A	16.7 A	27.1 A	27.1 A	31.3 A	±2%	240 mV
CNS658-MU	48 V	48 - 55.2 V	0 A	8.3 A	13.5 A	13.5 A	15.6 A	±2%	480 mV

¹ Peak load current not to exceed 10 seconds, Ta = 50 °C.

² Requires at least 400 LFM of airflow.

³ At 25 °C including factory setpoint, line voltage and load current variations.

⁴ Peak-to-peak ripple measured at the output terminal with 20 MHz bandwidth and 10 µF (tantalum capacitor) in parallel with 0.1 µF capacitor across the output.

⁵ Optional suffix "-ME" (end-fan) and "-MF" (open-frame) available on the 12 V output.

⁶ 80 PLUS certified.

Input Connections (-MU and -MF Suffix)

Pin	Function	Power Supply Side	System Side
TB1	PE	Dinkle EHK762V-03P Max Torque: 4kgf-cm	Recommended Wire Size: AWG #22 to #14
TB2	L2/Neutral		
TB3	L1/Line		

Input Connections (-ME Suffix)

Pin	Function	Power Supply Side	System Side
IEC Inlet	Input AC	IEC 60320 C14 (Male)	IEC Cord C13 (Female)

Output Connections

Pin	Function	Power Supply Side	System Side
BAR1	-Vout	Output Terminal Screw: M4X8 (4X) Max Torque: 10kgf-cm	Molex 19099-0032 or 19141-0063 for AWG #16 to #14 Molex 19099-0048 or 19141-0083 for AWG #12 to #10
BAR2	-Vout		
BAR3	+Vout		
BAR4	+Vout		

Other Output and Control Connections (Connector J304)

Pin	Designation	Description	
1	5VSB	+5 V Standby Output	J304 20-Pin Connector (PSU Side): Landwin: 2052P20008T or CviLux: CI0120P1HD0-LF
2	5VSB	+5 V Standby Output	
3	5VSB_GND	+5 V Standby Output Return/Ground	
4	SCL	Serial Clock Signal (I2C)	Recommended Mating Connectors: CviLux: CI0120SD000 (housing) CI01TD21PE0 (contact pins)
5	A0	EEPROM Address	
6	SDA	Serial Data Signal (I2C)	Landwin: 2050S2000 (housing)
7	I_SHARE	Active current share pin	2053T021V (contact pins)
8	SYS_GND	Return Ground for signals and I2C	JST: PHDR-20VS (housing)
9	12VFAN	12 V Fan Output	SPHD-001T-P0.5 (contact pins)
10	REMOTE INHIBIT	Output Inhibit Pin (Main Output)	
11	FAN_RTN	12 V Fan Output Return/Ground	
12	VIN_GOOD	Input Line OK Signal	
13	FAN_PWM1	FAN PWM	
14	PWOK	Output Power OK Signal	See ACCESSORIES Section
15	FAN_TACH1	Fan1 Tacho Signal	
16	FAN_OVERRIDE	External Fan Sensor for Override	
17	FAN_FAIL	Fain Fail Signal	
18	FAN_FAULT_EN	FAN Fault Enable Due to low RPM	
19	REMOTE_SENSE+	Positive Remote Sense	
20	REMOTE_SENSE-	Remote Sense Return	

Fan Output Connector for -MU, -MF Suffix (Connector J306)

Pin	Function	Description	
1	12VFAN	12 V fan output	J306 4-Pin Connector (PSU Side):
2	FAN_RTN	12 V fan return	CviLux: CI0104P1HK0-LF
3	FAN_PWM1	Fan PWM	Landwin: 2003P0401V
4	FAN_TACH1	Fan1 tachometer signal	Recommended Mating Connectors:
			CviLux: CI0104S0000 (housing)
			CviLux: CI01T01MPP0 (contact pins)
			Landwin: 2001S0400 (housing)
			Landwin: 2005T011R (contact pins)

Mechanical Drawings (“-MU” Suffix for U-Base Construction/12 V, 24 V and 48 V)

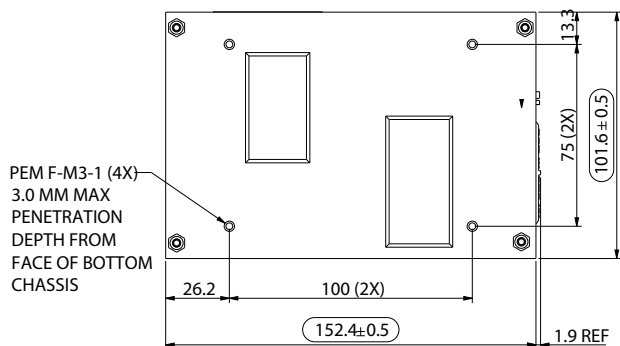
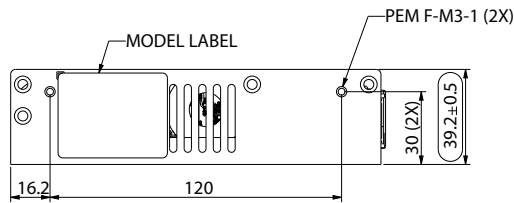
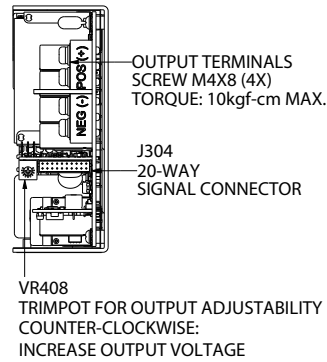
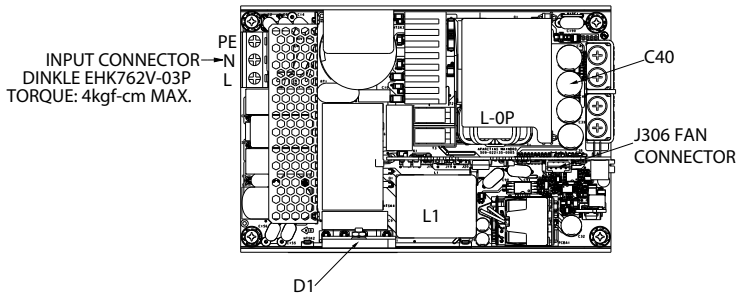
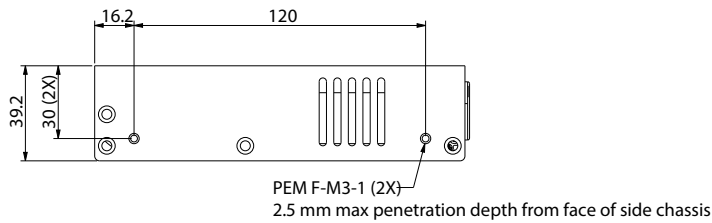

Thermal Hot Spot Reference	
Component	Temperature Limit (-MU)
D1 (AC bridge diode)	105 °C
L1 (PFC choke)	115 °C
C40 (output cap)	100 °C
L-output (output choke)	125 °C

Do not exceed indicated temperature limits to ensure operation is within the component thermal derating limits. Measure the component temperatures using K type thermocouples.

Unit weight (-MU suffix): 800 g

Mechanical Drawings (“-MF” Suffix for Open-frame Construction/12 V only)

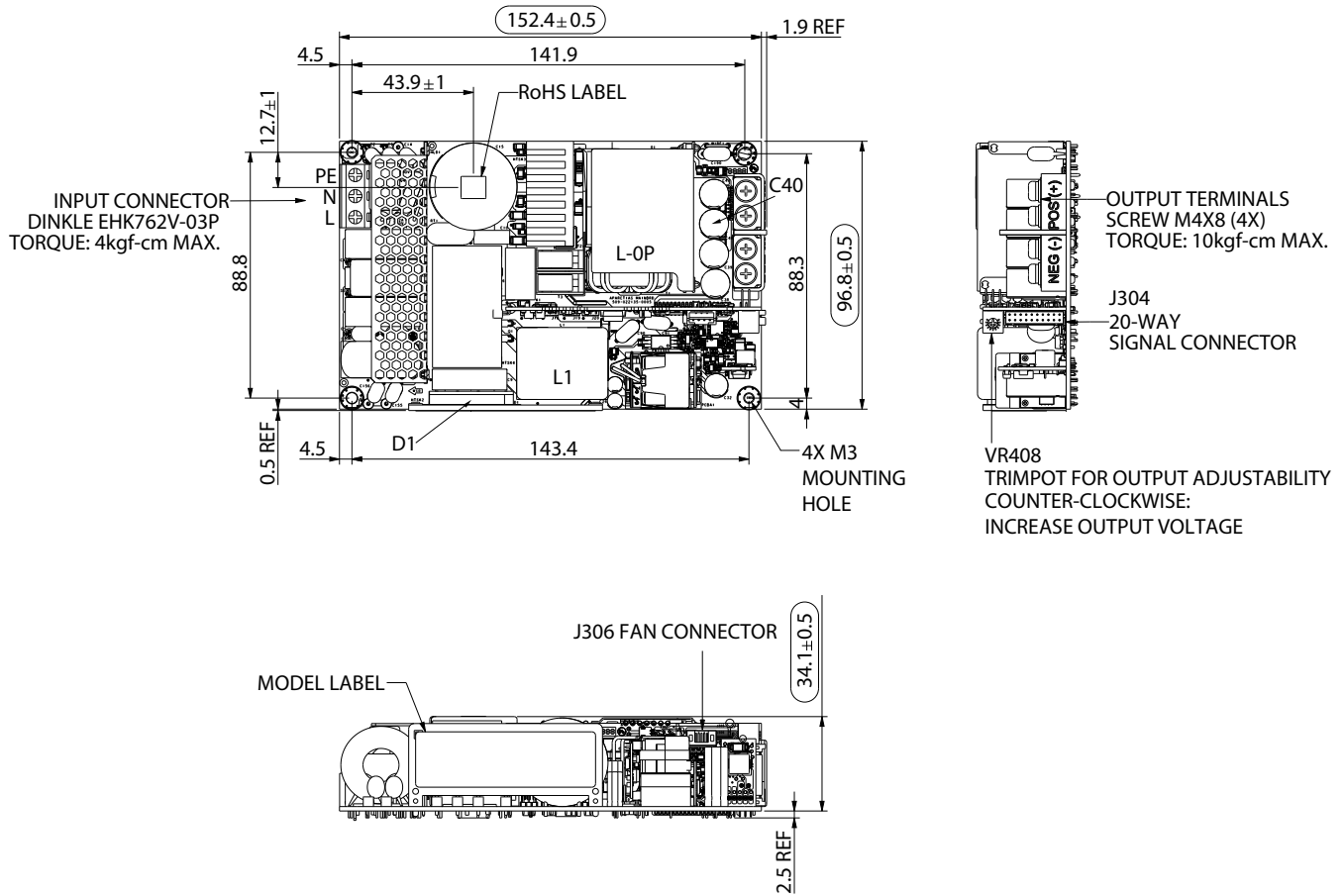

Thermal Hot Spot Reference	
Component	Temperature Limit (-MF)
D1 (AC bridge diode)	120 °C
L1 (PFC choke)	120°C
C40 (output cap)	100 °C
L-output (output choke)	125 °C

Do not exceed indicated temperature limits to ensure operation is within the component thermal derating limits. Measure the component temperatures using K type thermocouples.

Unit weight (-MF suffix): 650 g

Mechanical Drawings (“-ME” Suffix for End-fan Construction/12 V only)

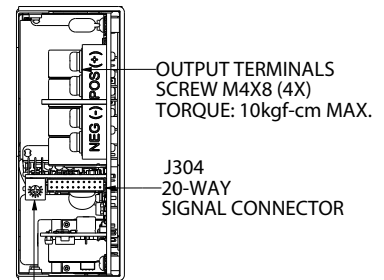
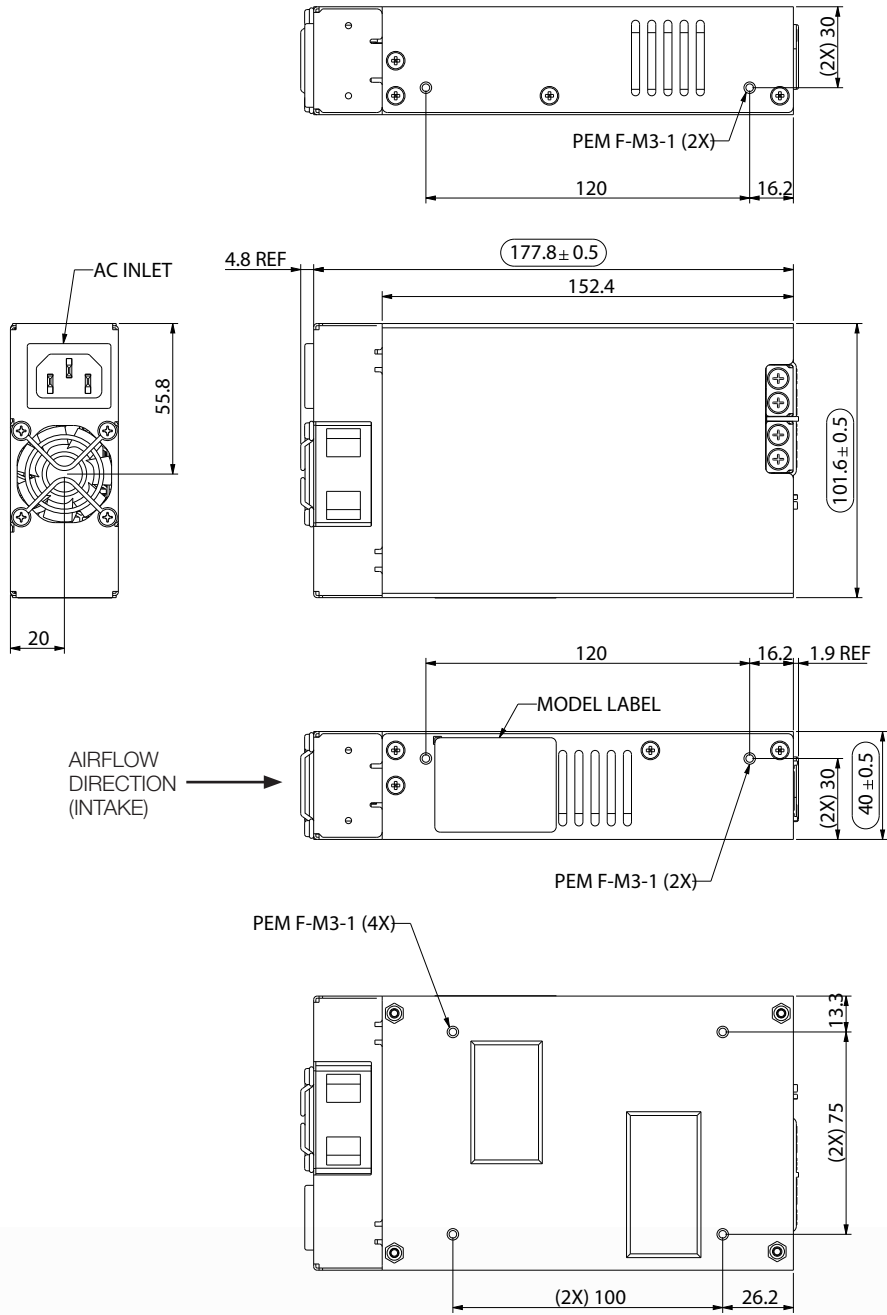

VR408 TRIMPOT FOR OUTPUT ADJUSTABILITY
 COUNTER-CLOCKWISE:
 INCREASE OUTPUT VOLTAGE

Unit weight (-ME suffix): 1000 g

Performance Curves

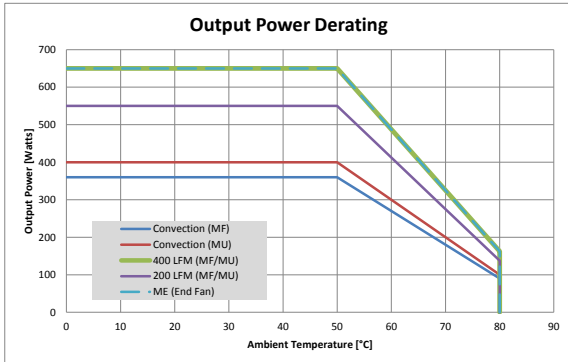

Figure 1. Output Power vs. Ambient Temperature at Natural Convection and Forced Air Cooling

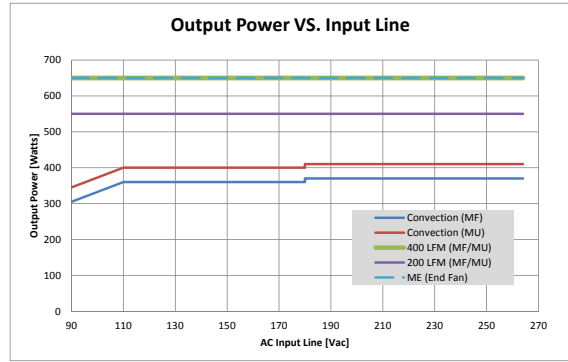

Figure 2. Output Power vs. Input Line at Natural Convection and Forced Air Cooling

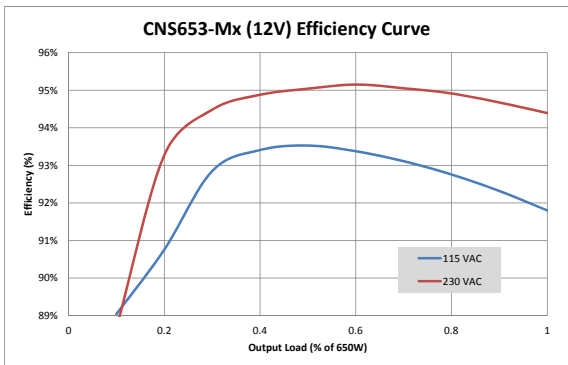

Figure 3. Typical Efficiency for 12 V Output

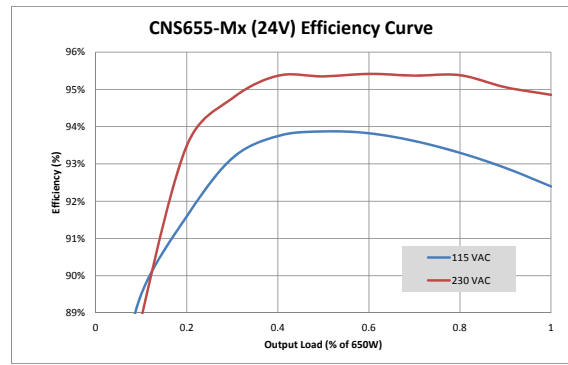

Figure 4. Typical Efficiency for 24 V Output

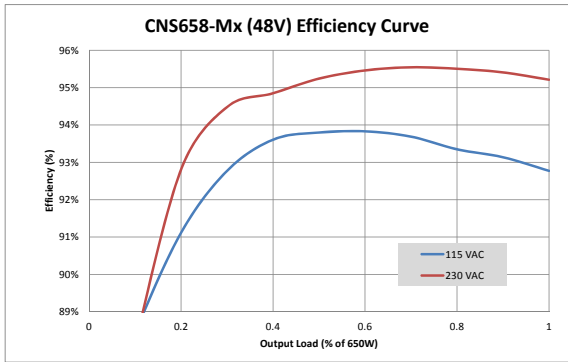

Figure 5. Typical Efficiency for 48 V Output

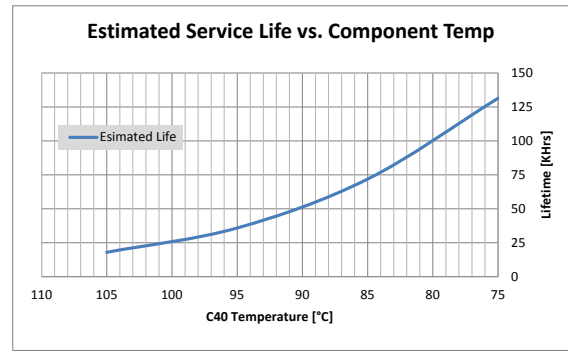

Figure 6. Estimated Product Useful Life Based on C40 Case Temperature

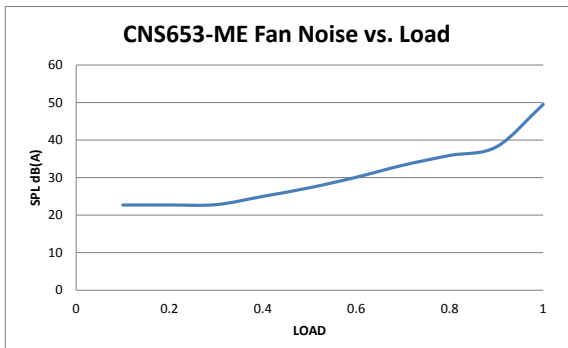
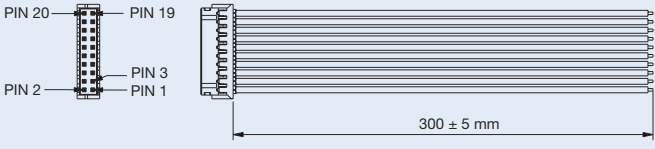
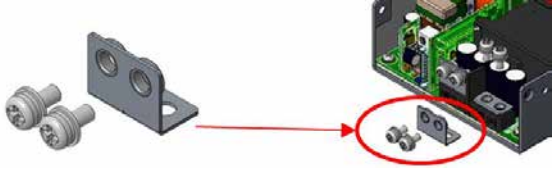



Figure 7. CNS653-ME (End Fan) typical audible noise level vs. Output Load at 90 VAC, ~30 °C Ambient.

Accessories

Orderable Part Number	Description	Description
73-788-001	J304 (20 Pin) Mating Connector with 0.3 m wires attached	
CNS-BBAR-KIT	Output Bussbar Extension Kit for Vertical Wire Interface	
73-769-002	USB to I ² C Adaptor for PMBus Communication	

WORLDWIDE OFFICES

Americas

2900 South Diablo Way
Suite B100
Tempe, AZ 85282, USA
+1 888 412 7832

Europe (UK)

Ground Floor Offices, Barberry House
4 Harbour Buildings, Waterfront West
Brierley Hill, West Midlands
DY5 1LN, UK
+44 (0) 1384 842 211

Asia (HK)

14/F, Lu Plaza
2 Wing Yip Street
Kwun Tong, Kowloon
Hong Kong
+852 2176 3333

ARTESYN[™]
An Advanced Energy Company

www.artesyn.com

For more information: www.artesyn.com
For support: productsupport.ep@artesyn.com

Данный компонент на территории Российской Федерации

Вы можете приобрести в компании MosChip.

Для оперативного оформления запроса Вам необходимо перейти по данной ссылке:

<http://moschip.ru/get-element>

Вы можете разместить у нас заказ для любого Вашего проекта, будь то серийное производство или разработка единичного прибора.

В нашем ассортименте представлены ведущие мировые производители активных и пассивных электронных компонентов.

Нашей специализацией является поставка электронной компонентной базы двойного назначения, продукции таких производителей как XILINX, Intel (ex.ALTERA), Vicor, Microchip, Texas Instruments, Analog Devices, Mini-Circuits, Amphenol, Glenair.

Сотрудничество с глобальными дистрибьюторами электронных компонентов, предоставляет возможность заказывать и получать с международных складов практически любой перечень компонентов в оптимальные для Вас сроки.

На всех этапах разработки и производства наши партнеры могут получить квалифицированную поддержку опытных инженеров.

Система менеджмента качества компании отвечает требованиям в соответствии с ГОСТ Р ИСО 9001, ГОСТ РВ 0015-002 и ЭС РД 009

Офис по работе с юридическими лицами:

105318, г.Москва, ул.Щербаковская д.3, офис 1107, 1118, ДЦ «Щербаковский»

Телефон: +7 495 668-12-70 (многоканальный)

Факс: +7 495 668-12-70 (доб.304)

E-mail: info@moschip.ru

Skype отдела продаж:

moschip.ru

moschip.ru_4

moschip.ru_6

moschip.ru_9