

IFX1963

1.5A Low Dropout Linear Voltage Regulator

IFX1963TBV
IFX1963TEV

Data Sheet

Rev. 1.0, 2013-02-25

Industrial Standard Power

Table of Contents

1	Overview	3
2	Block Diagram	5
3	Pin Configuration	6
3.1	Pin Assignment IFX1963TBV	6
3.2	Pin Definitions and Functions IFX1963TBV	6
3.3	Pin Assignment IFX1963TEV	7
3.4	Pin Definitions and Functions IFX1963TEV	7
4	General Product Characteristics	8
4.1	Absolute Maximum Ratings	8
4.2	Functional Range	9
4.3	Thermal Resistance	9
5	Electrical Characteristics	10
5.1	Electrical Characteristics Voltage Regulator	10
5.2	Typical Performance Characteristics	12
6	Application Information	19
6.1	Adjustable Operation	19
6.2	Output Capacitance and Transient Response	20
6.3	Overload Recovery	20
6.4	Output Voltage Noise	20
6.5	Protection Features	20
6.6	Further Application Information	21
7	Package Outlines	22
8	Revision History	24



1 Overview

Features

- Adjustable Output Voltage
- Output Voltage Tolerance at small loads of $\pm 1.5\%$
- Output Current Capability up to 1.5 A
- Very Low Dropout Voltage of 340 mV
- Extended Operating Range Starting at 1.7 V
- Low Noise of typ. $40 \mu\text{V}_{\text{RMS}}$ (10 Hz to 100 kHz)
- Small Output Capacitor for Stability 10 μF
- Suitable for Ceramic Output Capacitors
- Enable Functionality
- Overtemperature Shutdown
- Reverse Polarity Protection
- Output Current Limitation
- Wide Temperature Range From $-40\text{ }^\circ\text{C}$ up to $125\text{ }^\circ\text{C}$
- Green Product (RoHS compliant)

The **IFX1963** is not qualified and manufactured according to the requirements of Infineon Technologies with regards to automotive and/or transportation applications. For automotive applications please refer to the Infineon voltage regulator TLF1963 or in general to Infineon TLx (TLE, TLS, TLF.....) voltage regulator products.

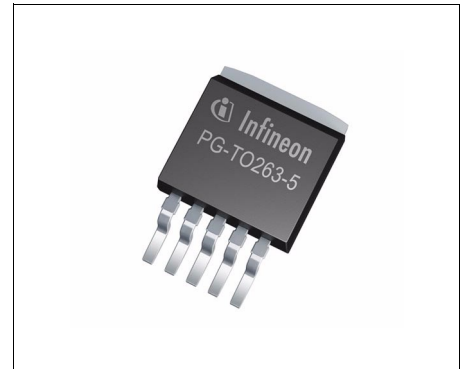

PG-TO263-5

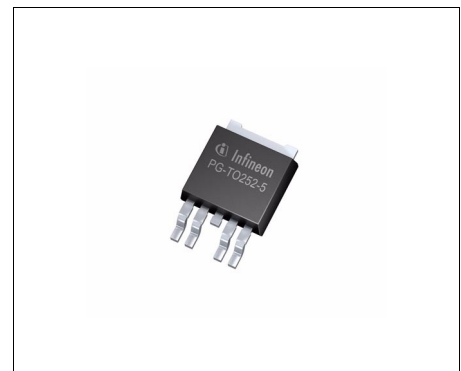

PG-TO252-5

Functional Description

The IFX1963 is a low dropout voltage regulator available in PG-TO263-5 and PG-TO252-5 SMD package. The IC regulates an input voltage V_{IN} in the range of $2.5\text{ V} < V_{\text{IN}} < 20\text{ V}$ to an adjustable output voltage of $1.21\text{ V} < V_{\text{OUT,nom}} < V_{\text{IN}} - V_{\text{DR}}$. The device is capable to supply loads up to 1.5 A. The regulator can be enabled and disabled via the Enable input. The integrated output current limitation and the overtemperature shutdown will protect the device against failures like output short circuit to GND, overcurrent and overtemperature.

The IFX1963 provides the ideal solution for systems requiring several supply voltages. With its adjust feature the regulator can provide all supply voltages between 1.21 V and the available input voltage, this offers a high flexibility to the system designer.

Type	Package	Marking
IFX1963TBV	PG-TO263-5	1963BV
IFX1963TEV	PG-TO252-5	1963EV

Choosing External Components

The input capacitor C_{IN} is necessary for compensating line influences. The output capacitor C_{OUT} is necessary for the stability of the regulating circuit. Stability is guaranteed at values specified in **“Functional Range” on Page 9** within the whole operating temperature range.

2 Block Diagram

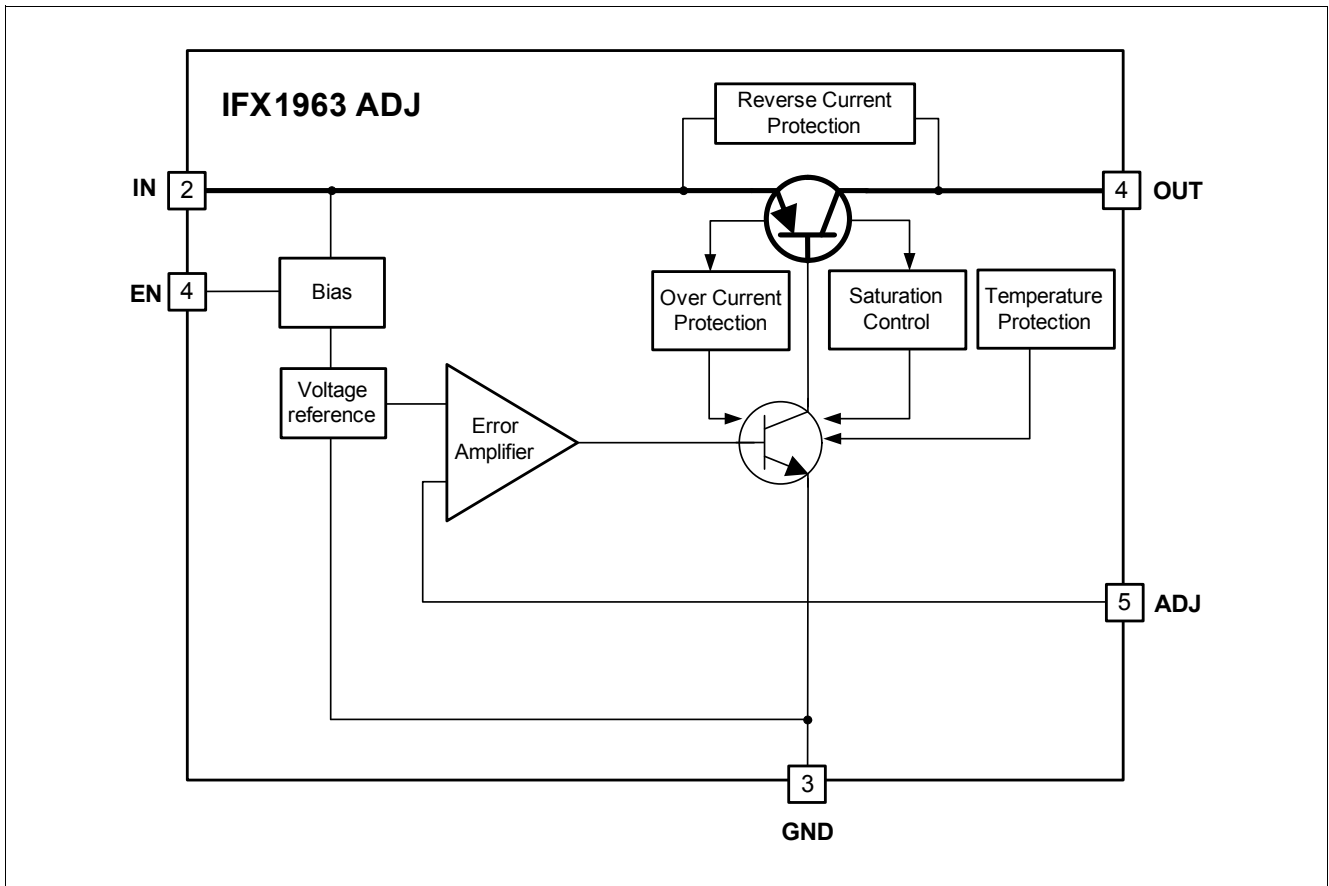

Figure 1 Block Diagram

3 Pin Configuration

3.1 Pin Assignment IFX1963TBV

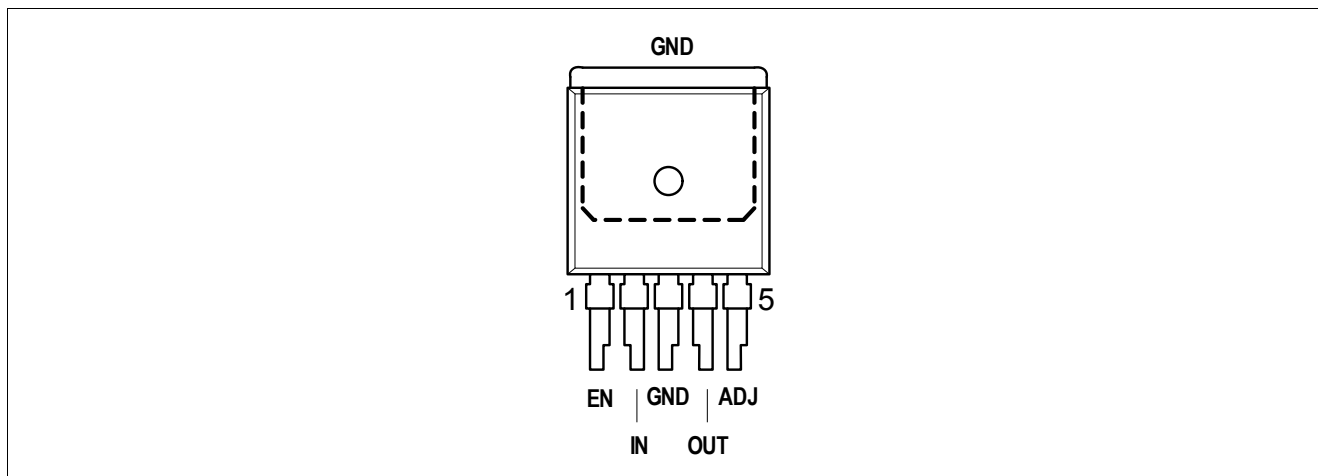

Figure 2 Pin Configuration PG-TO263-5

3.2 Pin Definitions and Functions IFX1963TBV

Pin	Symbol	Function
1	EN	Enable; A low signal disables the IC. A high signal switches it on. Connect to the input IN, if enable functionality is not required.
2	IN	Input voltage; IC supply. For compensating line influences, a capacitor close to the IC pins is recommended.
3	GND	Ground
4	OUT	Output voltage; Connect a capacitor between OUT and GND close to the IC terminals, respecting the values given for its capacitance C_{OUT} and ESR given in the table “Functional Range” on Page 9
5	ADJ	Adjust Input; Connect an external voltage divider from OUT to GND to determine the output voltage. By connecting the output pin OUT directly to the adjust pin ADJ without resistors an output voltage equal to the reference voltage $V_{ADJ} = 1.21\text{ V}$ is determined.
TAB	GND	Ground

3.3 Pin Assignment IFX1963TEV

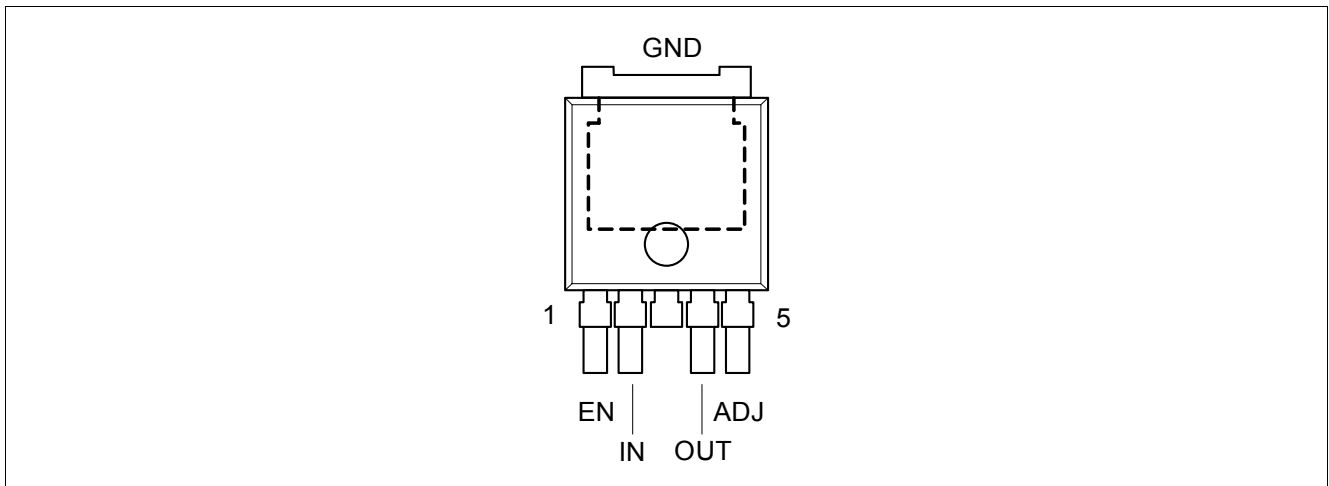

Figure 3 Pin Configuration PG-TO252-5

3.4 Pin Definitions and Functions IFX1963TEV

Pin	Symbol	Function
1	EN	Enable; A low signal disables the IC. A high signal switches it on. Connect to the input IN, if enable functionality is not required.
2	IN	Input voltage; IC supply. For compensating line influences, a capacitor close to the IC pins is recommended.
3	GND	Ground
4	OUT	Output voltage; Connect a capacitor between OUT and GND close to the IC terminals, respecting the values given for its capacitance C_{OUT} and ESR given in the table “Functional Range” on Page 9
5	ADJ	Adjust Input; Connect an external voltage divider from OUT to GND to determine the output voltage. By connecting the output pin OUT directly to the adjust pin ADJ without resistors an output voltage equal to the reference voltage $V_{ADJ} = 1.21 \text{ V}$ is determined.
TAB	GND	Ground

4 General Product Characteristics

4.1 Absolute Maximum Ratings

Table 1 Absolute Maximum Ratings ¹⁾
 $T_j = -40\text{ °C}$ to $+125\text{ °C}$; all voltages with respect to ground (unless otherwise specified)

Pos.	Parameter	Symbol	Limit Values		Unit	Conditions
			Min.	Max.		
Input, Enable						
4.1.1	Voltage	V_{IN}, V_{EN}	-20	20	V	–
Adjust						
4.1.2	Voltage	V_{ADJ}	-7	7	V	–
Output						
4.1.3	Voltage	V_{OUT}	-20	20	V	–
Temperatures						
4.1.4	Junction Temperature	T_j	-40	150	°C	–
4.1.5	Storage Temperature	T_{stg}	-50	150	°C	–
ESD Susceptibility						
4.1.6	ESD Resistivity	V_{ESD}	-2	2	kV	HBM ²⁾
4.1.7	ESD Resistivity	V_{ESD}	-750	750	V	CDM ³⁾

1) Not subject to production test, specified by design.

2) ESD susceptibility, HBM according to ANSI/ESDA/JEDEC JS001 (1.5k Ω , 100 pF)

3) ESD susceptibility, Charged Device Model "CDM" according JEDEC JESD22-C101

Note: Stresses above the ones listed here may cause permanent damage to the device. Exposure to absolute maximum rating conditions for extended periods may affect device reliability.

Note: Integrated protection functions are designed to prevent IC destruction under fault conditions described in the data sheet. Fault conditions are considered as "outside" normal operating range. Protection functions are not designed for continuous repetitive operation.

4.2 Functional Range

Table 2 Functional Range

Pos.	Parameter	Symbol	Limit Values		Unit	Conditions
			Min.	Max.		
4.2.1	Input voltage	V_{IN}	2.5	20	V	–
4.2.2	Output Capacitor's Requirements for Stability	C_{OUT}	10	–	μF	– ¹⁾
		$ESR(C_{OUT})$	–	3	Ω	– ²⁾
4.2.3	Junction temperature	T_j	-40	125	$^{\circ}\text{C}$	

1) the minimum output capacitance requirement is applicable for a worst case capacitance tolerance of 30%

2) relevant ESR value at $f = 10$ kHz

Note: Within the functional or operating range, the IC operates as described in the circuit description. The electrical characteristics are specified within the conditions given in the Electrical Characteristics table.

4.3 Thermal Resistance

Note: This thermal data was generated in accordance with JEDEC JESD51 standards. For more information, go to www.jedec.org.

Table 3 Thermal Resistance

Pos.	Parameter	Symbol	Limit Values			Unit	Conditions
			Min.	Typ.	Max.		
Package PG-TO263-5							
4.3.1	Junction to Case ¹⁾	R_{thJC}	–	0.84	–	K/W	measured to heat slug
4.3.2	Junction to Ambient ¹⁾	R_{thJA}	–	19	–	K/W	²⁾
4.3.3			–	64	–	K/W	footprint only ³⁾
4.3.4			–	36	–	K/W	300 mm ² heatsink area ³⁾
4.3.5			–	29	–	K/W	600 mm ² heatsink area ³⁾
Package PG-TO252-5							
4.3.6	Junction to Case ¹⁾	R_{thJC}	–	0.78	–	K/W	measured to heat slug
4.3.7	Junction to Ambient ¹⁾	R_{thJA}	–	24	–	K/W	²⁾
4.3.8			–	95	–	K/W	footprint only ³⁾
4.3.9			–	50	–	K/W	300 mm ² heatsink area ³⁾
4.3.10			–	38	–	K/W	600 mm ² heatsink area ³⁾

1) Not subject to production test, specified by design.

2) Specified R_{thJA} value is according to Jedec JESD51-2,-5,-7 at natural convection on FR4 2s2p board; The Product (Chip+Package) was simulated on a 76.2 x 114.3 x 1.5 mm³ board with 2 inner copper layers (2 x 70 μm Cu, 2 x 35 μm Cu). Where applicable a thermal via array under the exposed pad contacted the first inner copper layer.

3) Specified R_{thJA} value is according to Jedec JESD 51-3 at natural convection on FR4 1s0p board; The Product (Chip+Package) was simulated on a 76.2 x 114.3 x 1.5 mm³ board with 1 copper layer (1 x 70 μm Cu).

5 Electrical Characteristics

5.1 Electrical Characteristics Voltage Regulator

Table 4 Electrical Characteristics:

$V_I = 2.5 \text{ V} - 20 \text{ V}$, $T_j = -40 \text{ °C}$ to $+125 \text{ °C}$, all voltages with respect to ground, positive current flowing out of the pin (unless otherwise specified)

Pos.	Parameter	Symbol	Limit Values			Unit	Conditions
			Min.	Typ.	Max.		
5.1.1	Min. Input Voltage ^{1) 2)}	$V_{IN,min}$	–	1.7	–	V	$I_{OUT} = 0.5 \text{ A}$; $T_j = 25 \text{ °C}$
5.1.2		$V_{IN,min}$	–	2.1	2.5	V	$I_{OUT} = 1.5 \text{ A}$
5.1.3	Adjustable Pin Voltage ^{1) 3)}	V_{ADJ}	1.192	1.21	1.228	V	$V_{IN} = 2.21$ to 20 V ; $I_{OUT} = 1 \text{ mA}$; $T_j = 25 \text{ °C}$
5.1.4			1.174	1.21	1.246	V	$I_{OUT} = 1 \text{ mA}$ to 1.5 A
5.1.5	Line regulation ¹⁾	$\Delta V_{OUT,line}$	–	1.0	3	mV	$V_{IN} = 2.21$ to 20 V ; $I_{OUT} = 1 \text{ mA}$
5.1.6	Load regulation ¹⁾	$\Delta V_{OUT,load}$	–	2	8	mV	$I_{OUT} = 1 \text{ mA}$ to 1.5 A ; $V_{IN} = 2.5 \text{ V}$; $T_j = 25 \text{ °C}$
5.1.7			–	–	12	mV	$I_{OUT} = 1 \text{ mA}$ to 1.5 A ; $V_{IN} = 2.5 \text{ V}$
5.1.8	Dropout voltage ^{2) 4) 5)} $V_{IN} = V_{OUT,nom}$	V_{DR}	–	0.01	0.03	V	$I_{OUT} = 1 \text{ mA}$; $T_j = 25 \text{ °C}$
5.1.9			–	–	0.04	V	$I_{OUT} = 1 \text{ mA}$
5.1.10			–	0.03	0.05	V	$I_{OUT} = 100 \text{ mA}$; $T_j = 25 \text{ °C}$
5.1.11			–	–	0.09	V	$I_{OUT} = 100 \text{ mA}$
5.1.12			–	0.13	0.25	V	$I_{OUT} = 500 \text{ mA}$; $T_j = 25 \text{ °C}$
5.1.13			–	–	0.27	V	$I_{OUT} = 500 \text{ mA}$
5.1.14			–	0.34	0.45	V	$I_{OUT} = 1.5 \text{ A}$; $T_j = 25 \text{ °C}$
5.1.15			–	–	0.55	V	$I_{OUT} = 1.5 \text{ A}$
5.1.16	GND Pin Current ^{4) 6)} $V_{IN} = V_{OUT,nom} + 1 \text{ V}$	I_q	–	1.0	1.5	mA	$I_{OUT} = 0 \text{ mA}$
5.1.17			–	1.1	1.7	mA	$I_{OUT} = 1 \text{ mA}$
5.1.18			–	3.8	5.0	mA	$I_{OUT} = 100 \text{ mA}$
5.1.19			–	15	22	mA	$I_{OUT} = 500 \text{ mA}$
5.1.20			–	80	130	mA	$I_{OUT} = 1.5 \text{ A}$
5.1.21	Output Voltage Noise	$V_{OUT,noise}$	–	40	–	μV_{RMS}	$C_{OUT} = 10 \text{ }\mu\text{F}$; $I_{OUT} = 1.5 \text{ A}$; BW = 10 Hz to 100 kHz
5.1.22	ADJ Pin Bias Current ^{1) 7)}	I_{ADJ}	–	1	2	μA	–
5.1.23	Enable Threshold	$V_{EN,LH}$	–	1.4	2	V	$V_{OUT} = \text{Off to On}$
5.1.24		$V_{EN,HL}$	0.8	1.3	–	V	$V_{OUT} = \text{On to Off}$
5.1.25	EN Pin current ⁸⁾	I_{EN}	–	0	0.2	μA	$V_{EN} = 0 \text{ V}$
5.1.26			–	2.5	20	μA	$V_{EN} \leq 20 \text{ V}$

Table 4 Electrical Characteristics: (cont'd)
 $V_I = 2.5 \text{ V} - 20 \text{ V}$, $T_j = -40 \text{ }^\circ\text{C}$ to $+125 \text{ }^\circ\text{C}$, all voltages with respect to ground, positive current flowing out of the pin (unless otherwise specified)

Pos.	Parameter	Symbol	Limit Values			Unit	Conditions
			Min.	Typ.	Max.		
5.1.27	Quiescent Current in Shutdown ⁹⁾	$I_{q,off}$	–	0.01	1	μA	$V_{IN} = 6 \text{ V}$; $V_{EN} = 0 \text{ V}$; $T_j \leq 85 \text{ }^\circ\text{C}$
5.1.28	Power Supply ripple rejection ¹⁰⁾	$PSRR$	55	67	–	dB	$T_j = 25 \text{ }^\circ\text{C}$; $f_r = 120 \text{ Hz}$; $I_{OUT} = 0.75 \text{ A}$; $V_{IN} - V_{OUT} = 1.5 \text{ V}$; $V_r = 0.5 V_{pp}$
5.1.29	Output current limitation	I_{OUT}	–	2	–	A	$T_j = 25 \text{ }^\circ\text{C}$; $V_{IN} = 7 \text{ V}$; $V_{OUT} = 0 \text{ V}$
5.1.30		I_{OUT}	1.6	–	–	A	$V_{IN} = V_{OUT,nom} + 1 \text{ V}$; $dV_{OUT} = -0.1 \text{ V}$
5.1.31	Input Reverse Leakage Current	$I_{IN,rev}$	–	–	2	mA	$V_{IN} = -20 \text{ V}$; $V_{OUT} = 0 \text{ V}$
5.1.32	Reverse Output Current ¹⁾¹¹⁾	$I_{OUT,rev}$	–	300	600	μA	$T_j = 25 \text{ }^\circ\text{C}$; $V_{OUT} = 1.21 \text{ V}$; $V_{IN} = 0 \text{ V}$
5.1.33			–	–	1	mA	$V_{OUT} = 1.21 \text{ V}$; $V_{IN} = 0 \text{ V}$

- 1) The IFX1963 is tested and specified for these conditions with the ADJ pin connected to the OUT pin.
- 2) For IFX1963 dropout voltage will be limited by the minimum input voltage specification under some output voltage/load conditions.
- 3) Operating conditions are limited by maximum junction temperature. The regulated output voltage specification will not apply for all possible combinations of input voltage and output current. When operating at maximum input voltage, the output current range must be limited. When operating at maximum output current, the input voltage range must be limited.
- 4) To satisfy requirements for minimum input voltage, the IFX1963 is tested and specified for these conditions with an external resistor divider (two 4.12 k Ω resistors) for an output voltage of 2.4 V. The external resistor divider will add a 300 μA DC load on the output.
- 5) Dropout voltage is the minimum input to output voltage differential needed to maintain regulation at a specified output current. In dropout, the output voltage will be equal to: $V_{IN} - V_{DR}$
- 6) GND pin current is tested with $V_{IN} = V_{OUT,nom} + 1 \text{ V}$ and a current source load.
- 7) ADJ pin bias current flows into the ADJ pin.
- 8) EN pin current flows into the EN pin.
- 9) Specified by design, tested at $T_{amb} = 25 \text{ }^\circ\text{C}$
- 10) Not subject to production test, specified by design.
- 11) Reverse output current is tested with the IN pin grounded and the OUT pin forced to the rated output voltage. The reverse output current flows into the OUT pin.

5.2 Typical Performance Characteristics

Dropout Voltage V_{DR} versus Output Current I_{OUT}

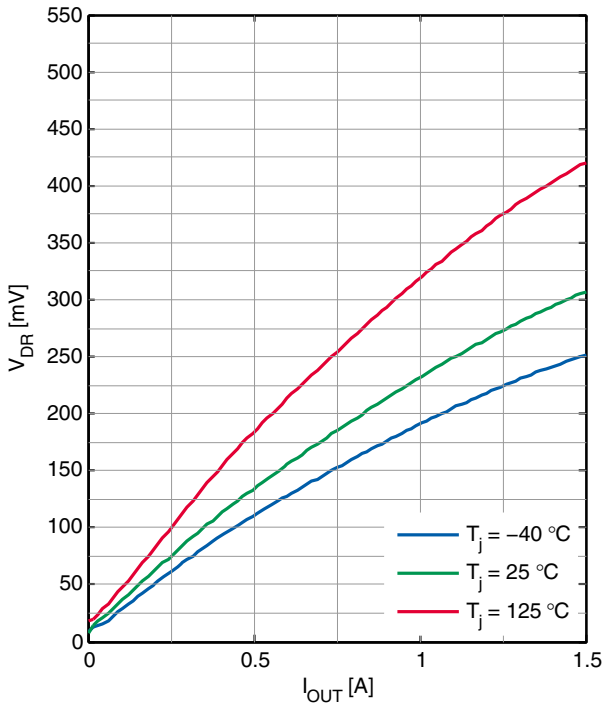

Guaranteed Dropout Voltage V_{DR} versus Output Current I_{OUT}

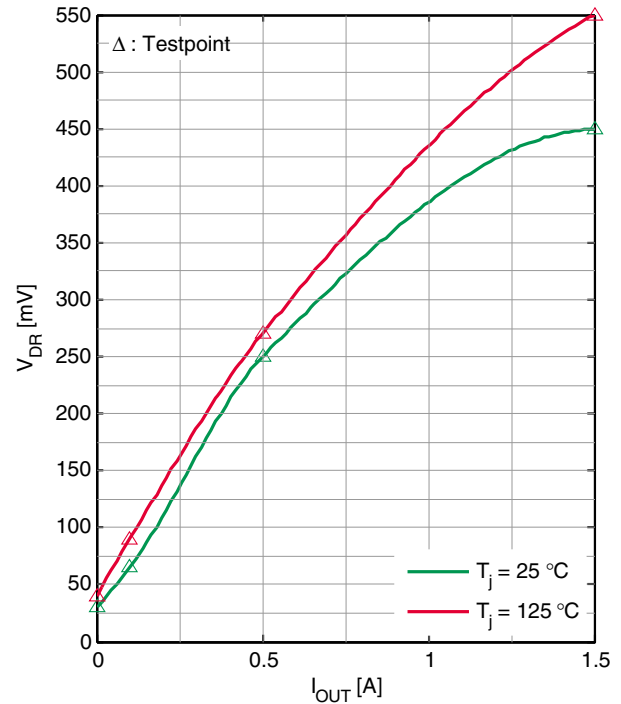

Dropout Voltage V_{DR} versus Temperature T_j

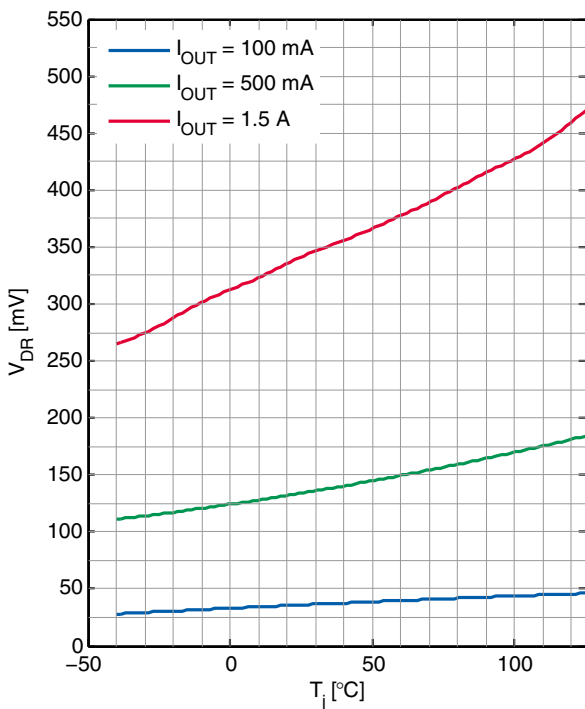

Quiescent Current I_q versus Temperature T_j

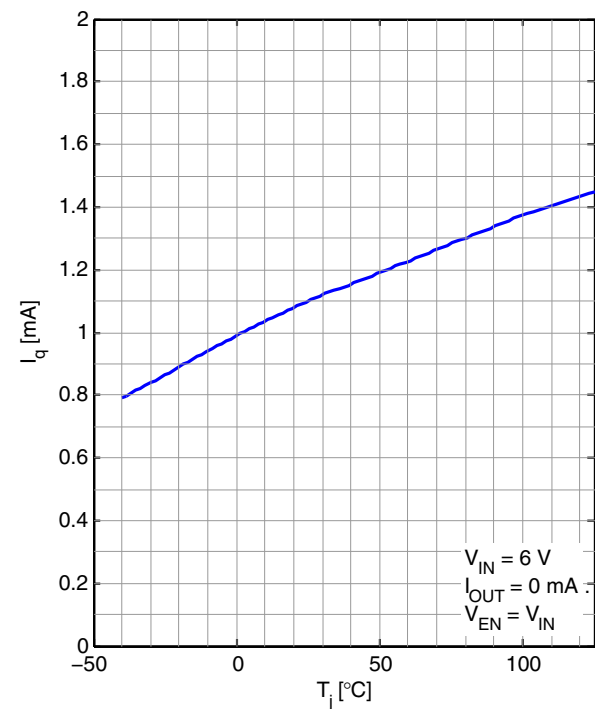

Adjustable Voltage V_{ADJ} versus Temperature T_j

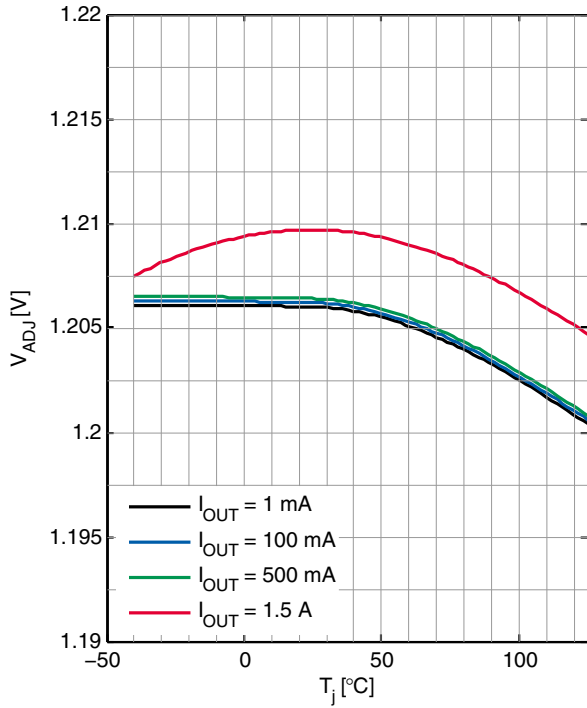

Quiescent Current I_q versus Input Voltage V_{IN} ($V_{OUT,nom} = 2.5 V$)

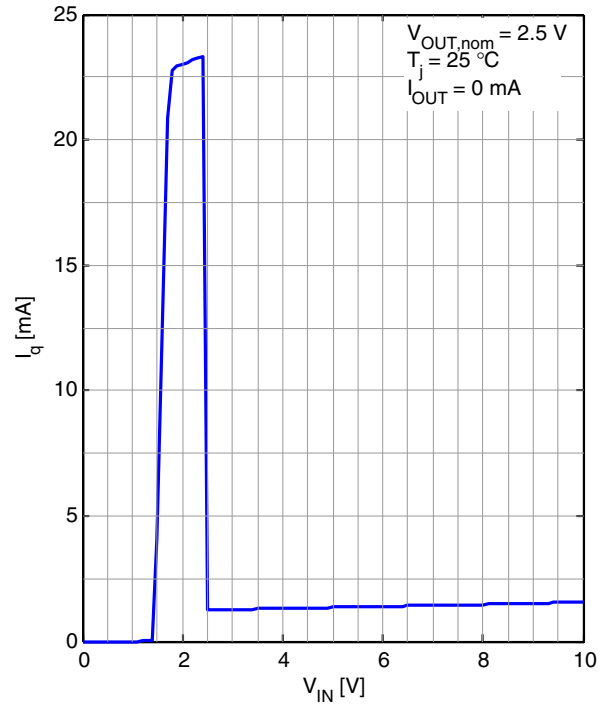

Quiescent Current I_q versus Input Voltage V_{IN} ($V_{OUT,nom} = 1.21 V$)

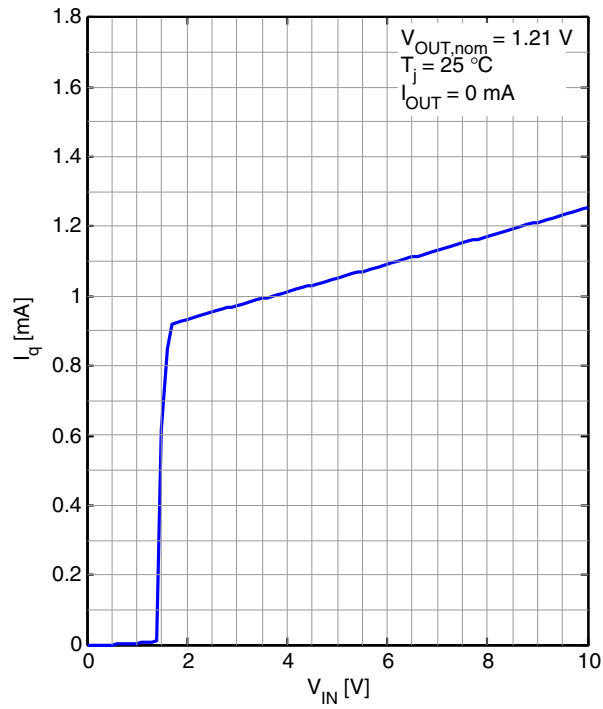

GND Pin Current I_{GND} versus Output Current I_{OUT}

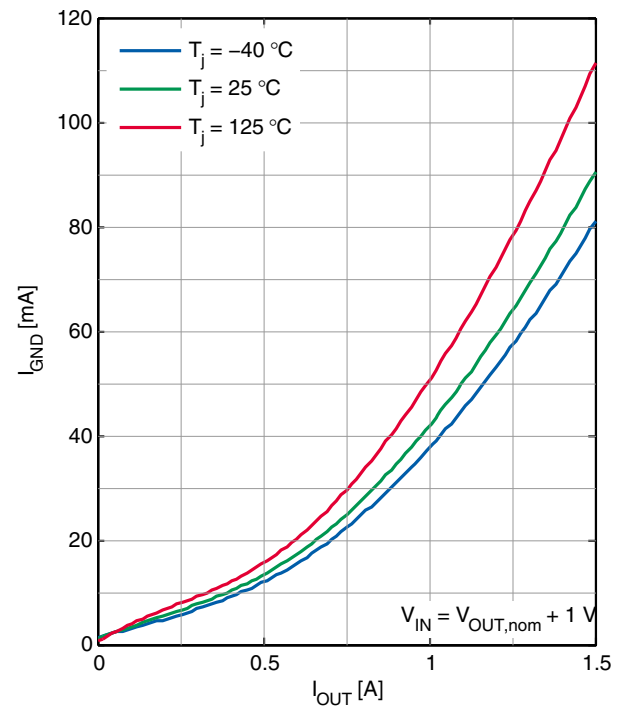

GND Pin Current I_{GND} versus Input Voltage V_{IN} ($V_{OUT,nom} = 2.5\text{ V}$)

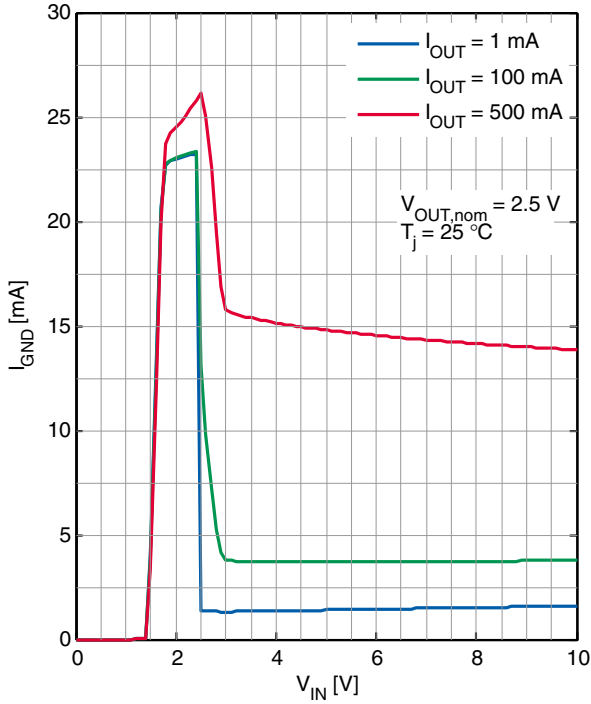

GND Pin Current I_{GND} versus Input Voltage V_{IN} ($V_{OUT,nom} = 1.21\text{ V}$)

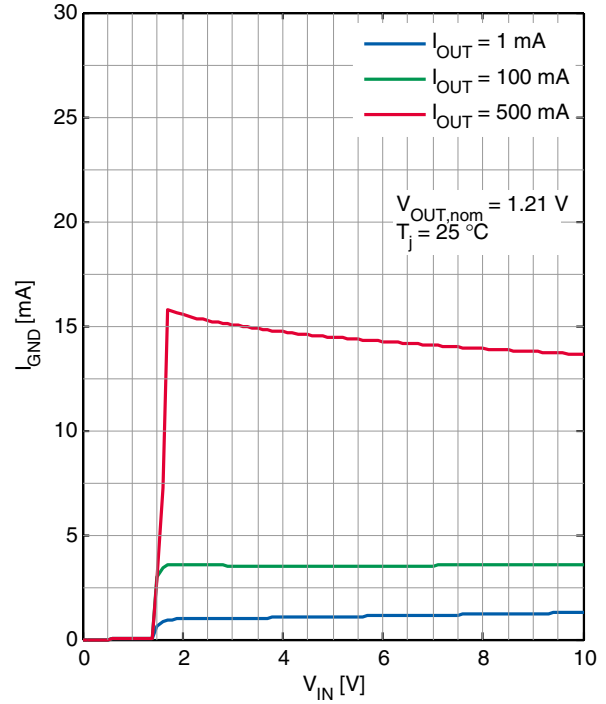

GND Pin Current I_{GND} versus Input Voltage V_{IN} ($V_{OUT,nom} = 2.5\text{ V}$)

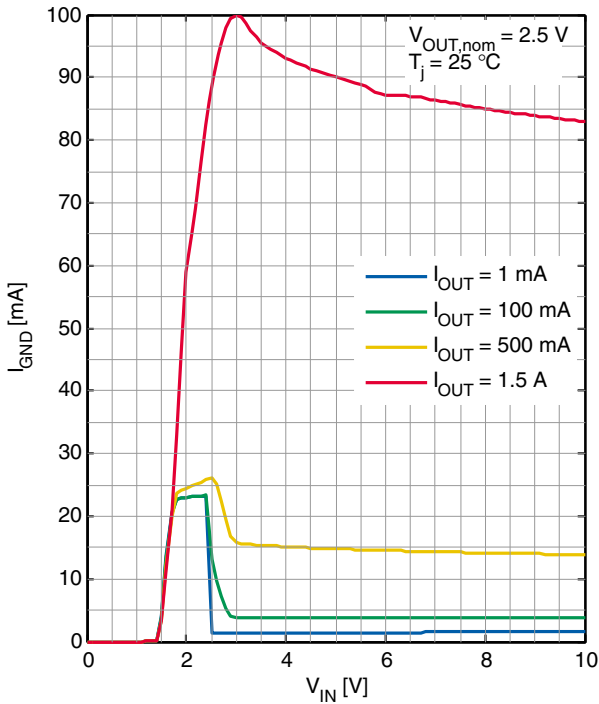

GND Pin Current I_{GND} versus Input Voltage V_{IN} ($V_{OUT,nom} = 1.21\text{ V}$)

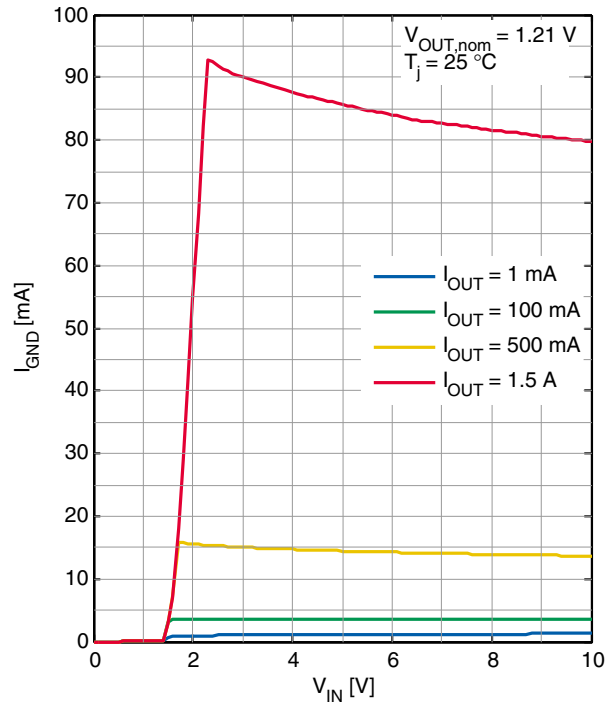

EN Pin Thresholds $V_{EN,th}$ versus Temperature T_j

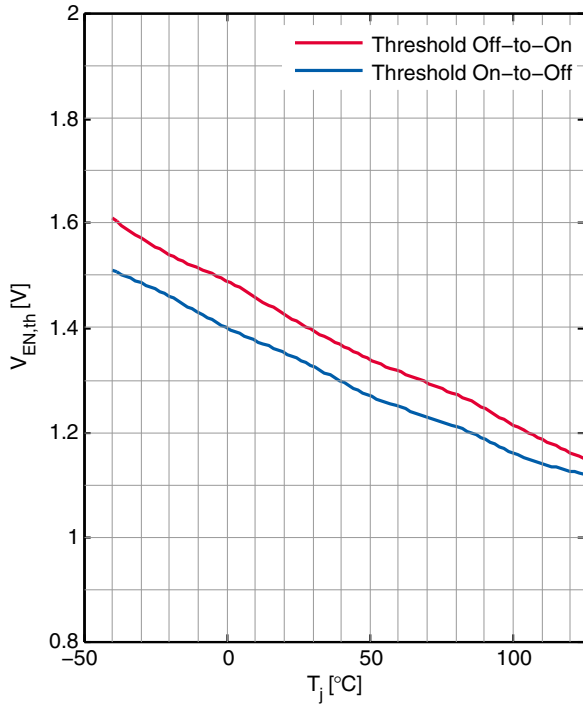

EN Pin Input Current I_{EN} versus EN Pin Voltage V_{EN}

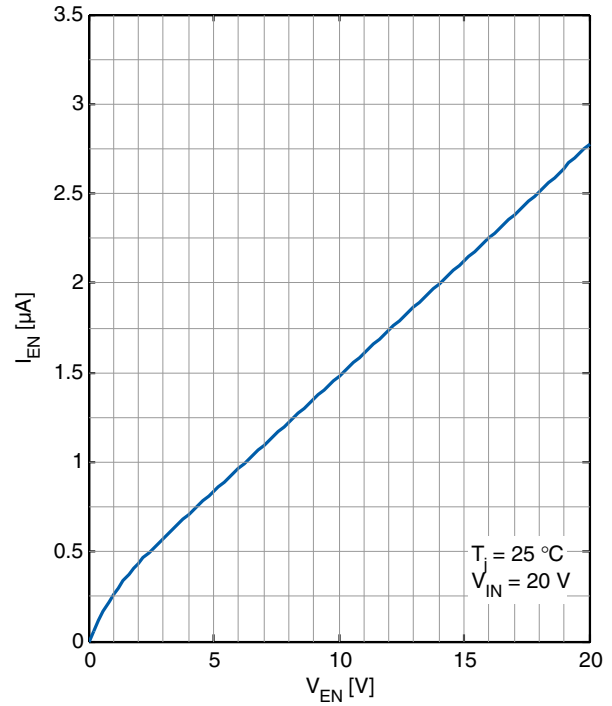

EN Pin Input Current I_{EN} versus Temperature T_j

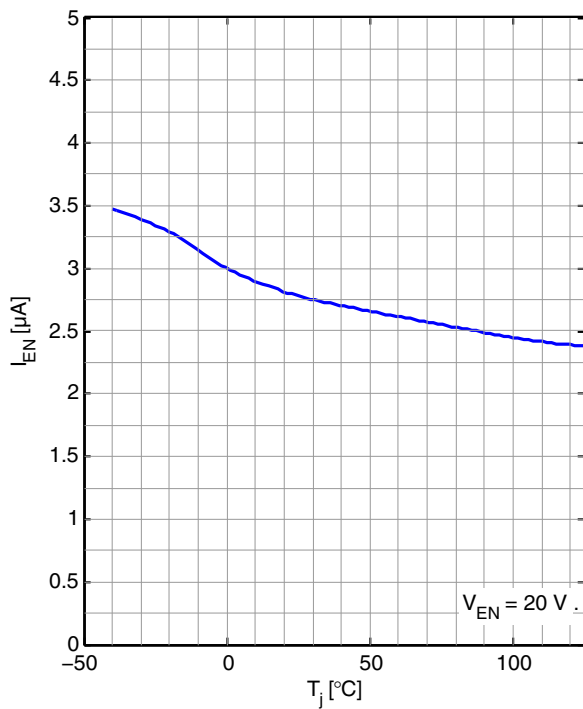

Adjustable Pin Bias Current I_{ADJ} versus Temperature T_j

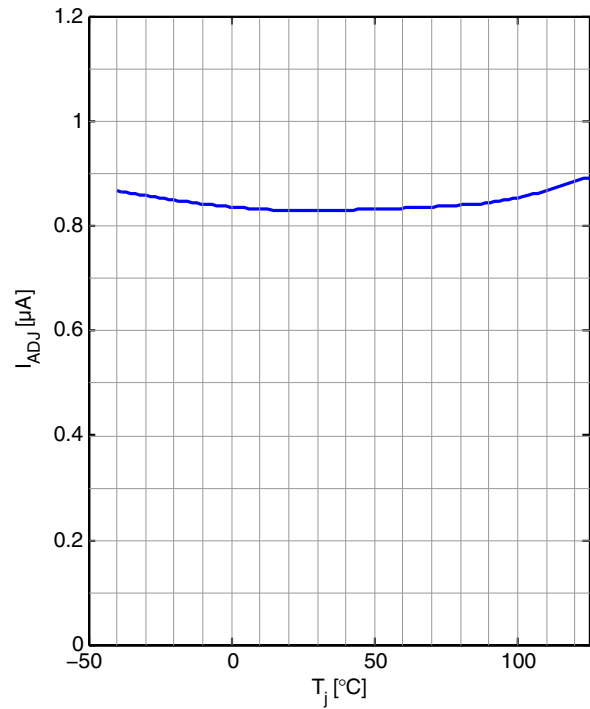

Current Limit $I_{OUT,max}$ versus Input / Output Differential $V_{IN} - V_{OUT}$

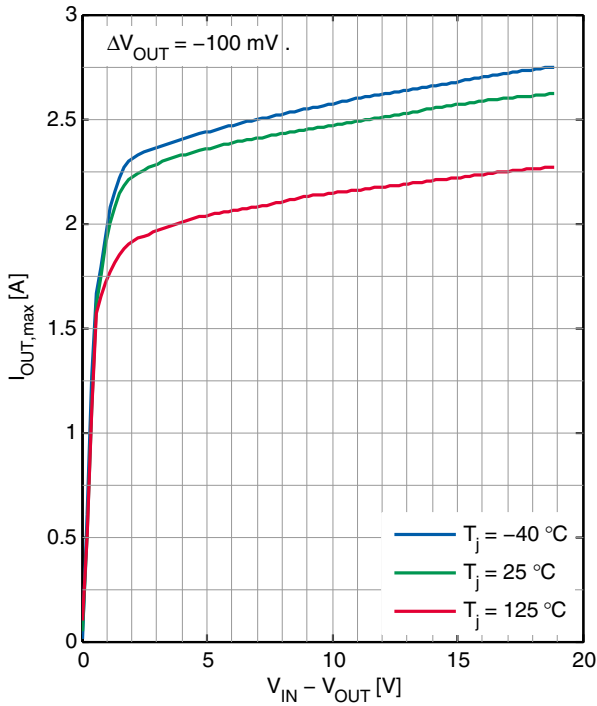

Current Limit $I_{OUT,max}$ versus Temperature T_j

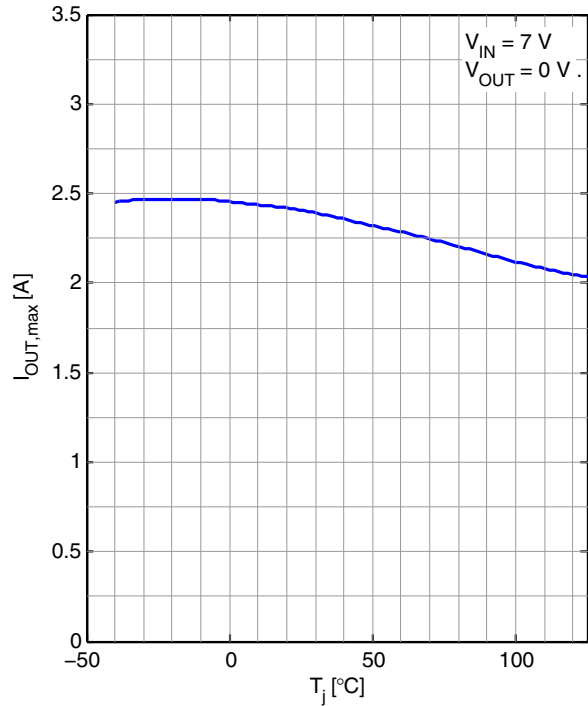

Reverse Output Current $I_{OUT,rev}$ versus Output Voltage V_{OUT}

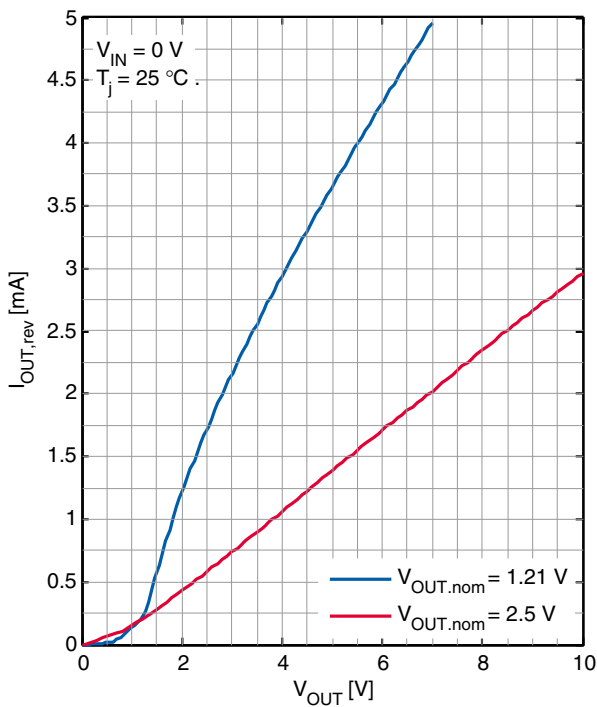

Reverse Output Current $I_{OUT,rev}$ versus Temperature T_j

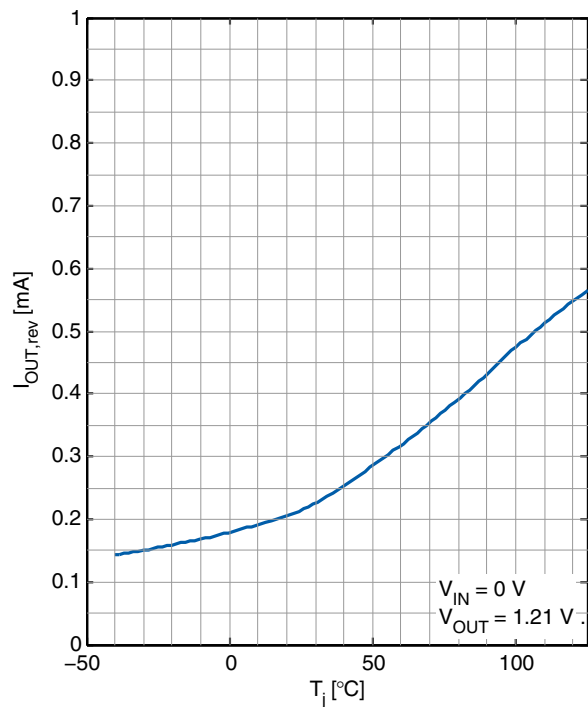

Ripple Rejection PSRR versus Frequency f

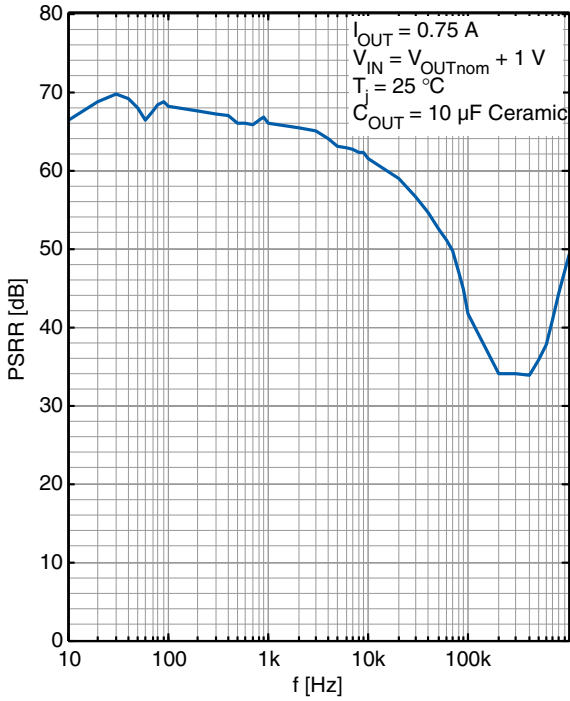

Ripple Rejection PSRR versus Temperature T_j

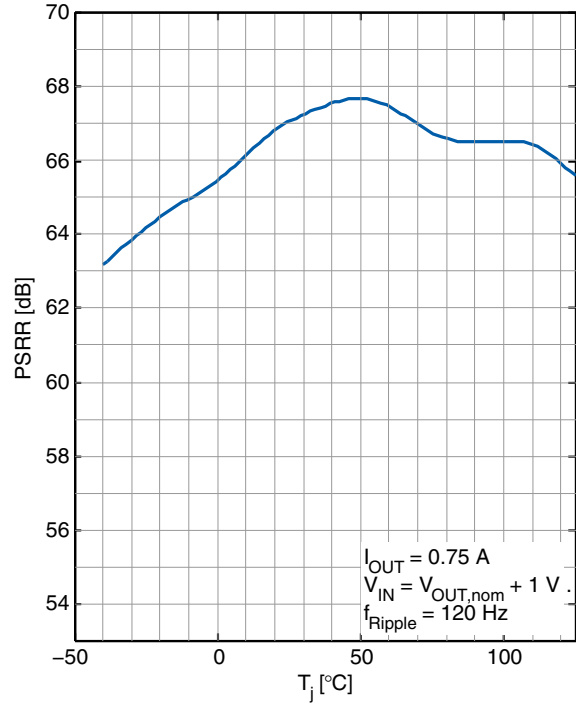

Minimum Input Voltage $V_{IN,min}$ versus Temperature T_j

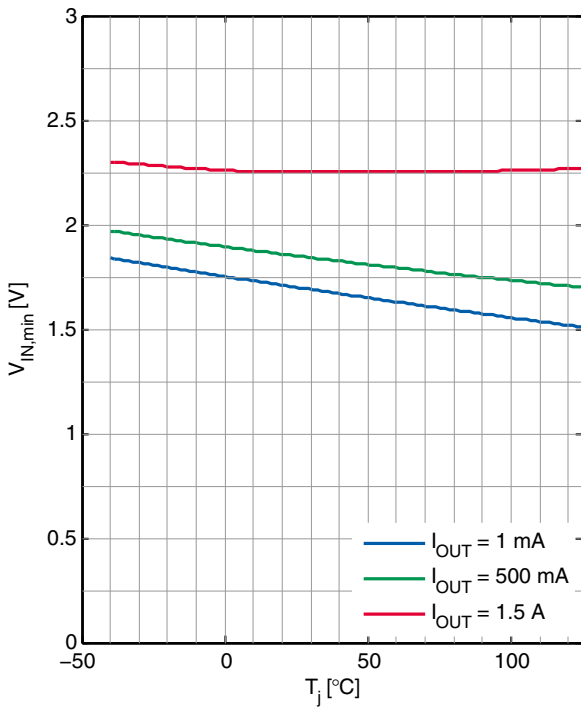

Load Regulation dV_{Load} versus Temperature T_j

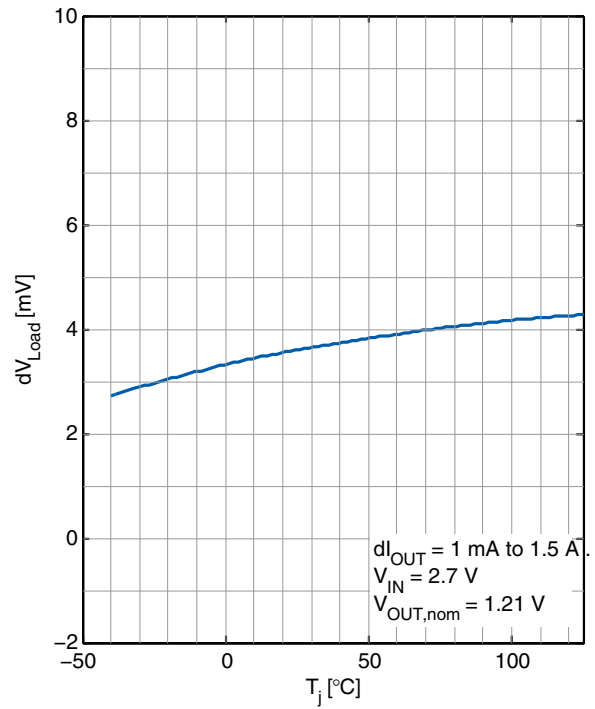

Equivalent Series Resistance $ESR(C_{OUT})$ vs Load Current I_{OUT}

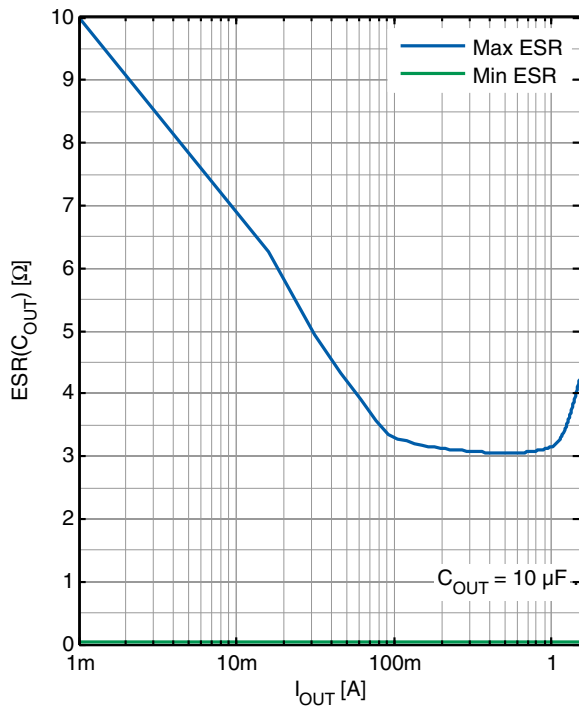

6 Application Information

Note: The following information is given as a hint for the implementation of the device only and shall not be regarded as a description or warranty of a certain functionality, condition or quality of the device.

The IFX1963 is an 1.5 A low dropout regulator optimized for fast transient response. The device is capable of supplying 1.5 A at a very low dropout voltage up to a Junction Temperature of 125 °C. The low operating quiescent current of typical 1 mA drops to less than 1 µA in case the device is disabled. In addition to the low quiescent current, the IFX1963 incorporates several protection features which make them ideal for use in battery-powered systems. The device is protected against both reverse input and reverse output voltages.

Note: This is a very simplified example of an application circuit. The function must be verified in the real application.

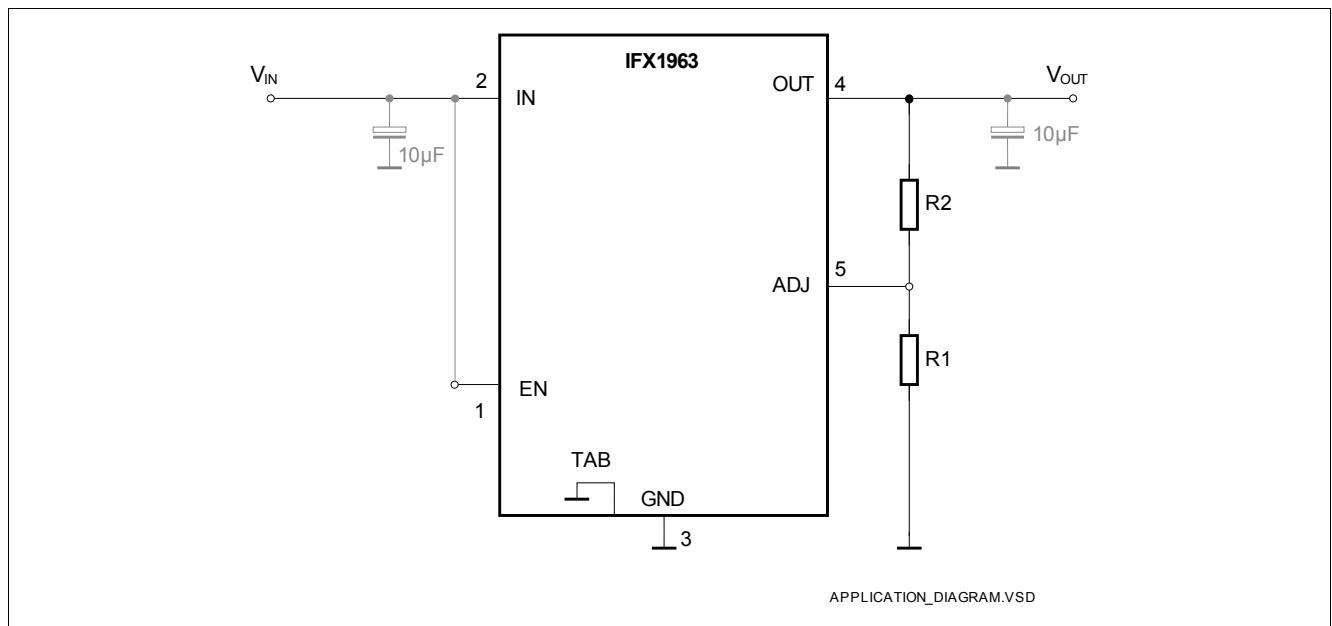

Figure 4 Application Diagram

6.1 Adjustable Operation

The IFX1963 has an output voltage range of 1.21 V to $V_{IN} - V_{DR} < 20$ V. The output voltage is set by the ratio of two external resistors as shown in [Figure 4](#). The device serves the output to maintain the voltage at the ADJ pin at 1.21 V referenced to ground. The current in R1 is then equal to $1.21 \text{ V} / R_1$ and the current in R2 is the current in R1 plus the ADJ pin bias current. The ADJ pin bias current, 1 µA at 25 °C, flows through R2 into the ADJ pin. The output voltage can be calculated using the formula in [Equation \(1\)](#).

$$V_{OUT} = V_{ADJ} \cdot \left(1 + \frac{R_2}{R_1}\right) + I_{ADJ} \cdot R_2 \quad (1)$$

$V_{ADJ} = 1.21 \text{ V}$ typical

$I_{ADJ} = 1 \text{ µA}$ at 25 °C

The value of R1 is recommended to be smaller than 12 kΩ to minimize errors in the output voltage caused by the ADJ pin bias current. Note that in shutdown the output is turned off and the divider current will be zero.

The adjustable device is in many cases tested and specified with the ADJ pin connected to the OUT pin for an output voltage of 1.21 V. Specifications for output voltages adjusted to greater values than 1.21V will be proportional to the ratio of the desired output voltage to 1.21 V.

For example, load regulation for an output current change of 1 mA to 1.5 A is $\Delta V_{OUT,load} = 2 \text{ mV}$ typical at $V_{OUT,nom} = 1.21 \text{ V}$.

At $V_{OUT,nom} = 5 \text{ V}$, load regulation is: $\Delta V_{OUT,load,5V} = (5 \text{ V} / 1.21 \text{ V}) \cdot (2 \text{ mV}) = 8.3 \text{ mV}$

6.2 Output Capacitance and Transient Response

The IFX1963 is designed to be stable with a wide range of output capacitors. The ESR of the output capacitor affects stability, most notably with small capacitors. A minimum output capacitor of 10 μF with an ESR in the range of 10 m Ω to 3 Ω is recommended to prevent oscillations. Larger values of output capacitance can decrease the peak deviations and provide improved transient response for larger load current changes.

6.3 Overload Recovery

The IFX1963 has a safe operating area protection. The device protects itself by limiting the output current to a maximum and prevent it self against destruction due to overload or short circuits conditions. In this cases the current is limited and the resulting output voltage decreases according to the load down to 0V in a short circuit condition.

The IFX1963 can supply the application for all input voltages between 2.5 V up to 20V with currents up to 1.5 A. Of course it needs to be ensured, that the junction temperature stays within the operating range up to 125 °C. For startup conditions with a high load current the IFX1963 is able to start up properly without exceeding the safe operating area. Even imediatly after removal of a short circuit failure case the device is able to start if the load current is very high. The characteristic of the current limitation can by seen in the typical performance graphs on [Page 16](#).

6.4 Output Voltage Noise

The IFX1963 has been designed to provide low output voltage noise over the 10 Hz to 100 kHz bandwidth while operating at full load. Output voltage noise is typically 40 μV_{RMS} over this frequency bandwidth. For higher output voltages (generated by using a resistor divider), the output voltage noise will be gained up accordingly.

Higher values of output voltage noise may be measured when care is not exercised with regards to circuit layout and testing. Crosstalk from nearby traces can induce unwanted noise onto the output of the IFX1963. Power supply ripple rejection must also be considered, because the IFX1963 does not have unlimited power supply ripple rejection and will pass a small portion of the input noise through to the output.

6.5 Protection Features

The IFX1963 has several protection features which makes it ideal for use in battery-powered circuits. In addition to the normal protection features associated with monolithic regulators, such as current limiting and thermal limiting, the device is protected against reverse input voltages and reverse output voltages.

Current limit protection and thermal overload protection are intended to protect the device against current overload conditions at the output of the device. For normal operation, the junction temperature should not exceed 125 °C.

The input of the device will withstand reverse voltages of 20 V. Current flow out of the device will be limited to less than 2 mA in case of an input voltage of -20 V at the Input and no negative voltage will appear at the output. The device will protect both itself and the load. This provides protection against batteries that can be plugged in backward.

The output of the IFX1963 can be pulled below ground without damaging the device. If the input is left open circuit or grounded, the output can be pulled below ground by 20 V. The output will act like an open circuit, no current will flow out of the pin. If the input is powered by a voltage source, the output will source the short-circuit current of the device and will protect itself by thermal limiting. In this case, grounding the EN pin will turn off the device and stop the output from sourcing the short-circuit current.

In case the input of the IFX1963 is low ($V_{\text{IN}} = 0\text{V}$) while the output is forced to values $> 0\text{V}$ (e.g. $V_{\text{OUT,nom}}$) the resulting reverse output current $I_{\text{OUT,rev}}$ is according to the specification [5.1.32](#) and [5.1.33](#) in [Table 4](#). Further details are depicted in the typical performance graph “[Reverse Output Current I_{OUT,rev} versus Output Voltage V_{OUT}](#)” on [Page 16](#). Please note that the specification of $I_{\text{OUT,rev}}$ is reflecting the behaviour when the regulator is unpowered and is not regulating. In case of $V_{\text{IN}} > 1.21\text{V}$ while the output of the IFX1963 is forced to a

Application Information

voltage higher than V_{IN} (i.e. $V_{OUT} > V_{IN}$) the reverse output current $I_{OUT,rev}$ may – depending on actual conditions – rise to higher values and also flow out of the IN pin.

The ADJ pin of the adjustable device can be pulled above or below ground by as much as 7 V without damaging the device. If the input is left open circuit or grounded, the ADJ pin will act like an open circuit when pulled below ground and like a resistor (typically 4 k Ω) in series with a diode when pulled above ground.

In situations where the ADJ pin is connected to a resistor divider that would pull the ADJ pin above its 7 V clamp voltage if the output is pulled high, the ADJ pin input current must be limited to less than 5 mA. For example, a resistor divider is used to provide a regulated 1.5V output from the 1.21 V reference when the output is forced to 20 V. The top resistor of the resistor divider must be chosen to limit the current into the ADJ pin to less than 5 mA when the ADJ pin is at 7 V. The 13 V difference between OUT and ADJ pins divided by the 5 mA maximum current into the ADJ pin yields a minimum top resistor value of 2.6 k Ω .

6.6 Further Application Information

- For further information you may contact <http://www.infineon.com/>

7 Package Outlines

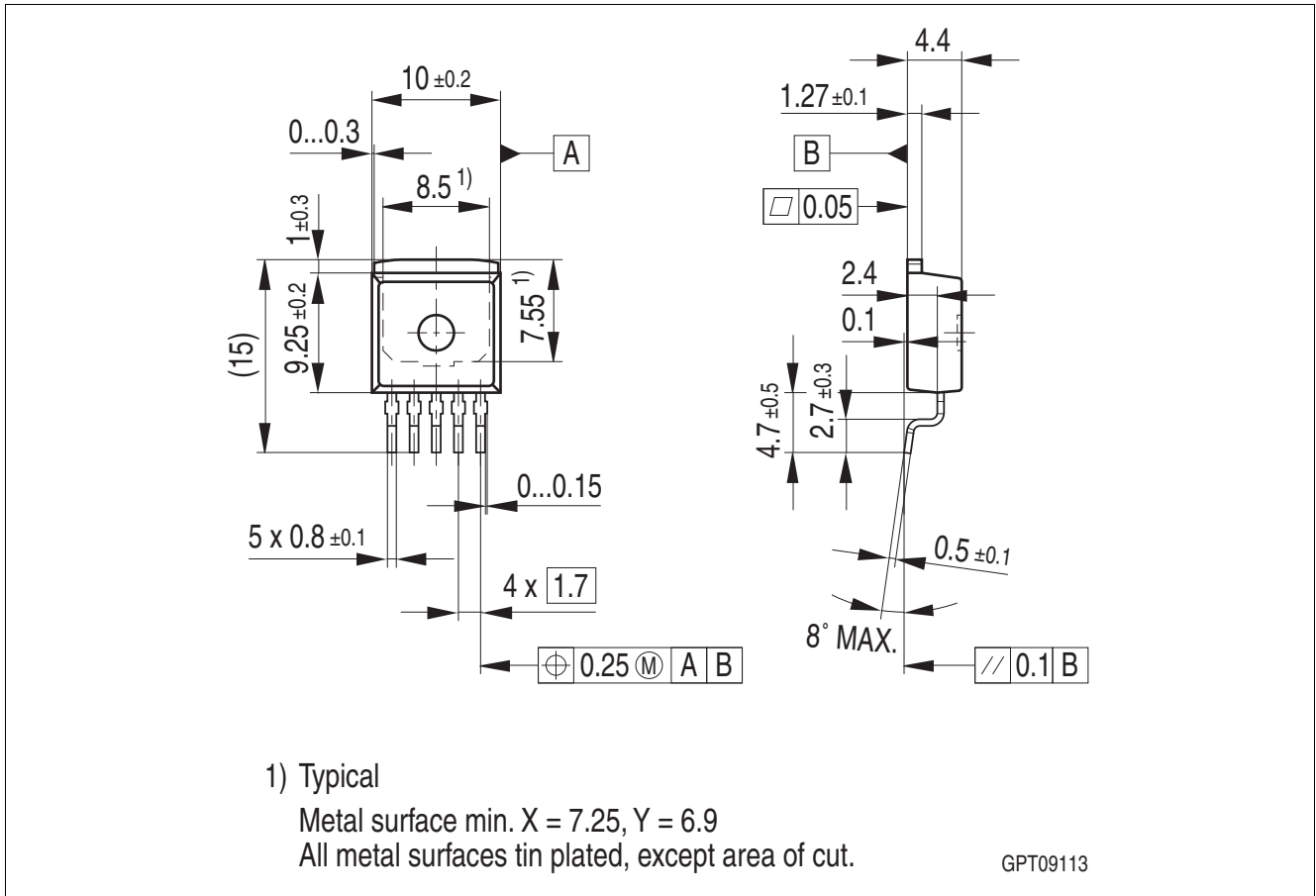

Figure 5 PG-TO263-5 SMD Package

8 Revision History

Revision	Date	Changes
1.0	2013-02-25	Data Sheet - Initial Release

Edition 2013-02-25

**Published by
Infineon Technologies AG
81726 Munich, Germany**

**© 2013 Infineon Technologies AG
All Rights Reserved.**

Legal Disclaimer

The information given in this document shall in no event be regarded as a guarantee of conditions or characteristics. With respect to any examples or hints given herein, any typical values stated herein and/or any information regarding the application of the device, Infineon Technologies hereby disclaims any and all warranties and liabilities of any kind, including without limitation, warranties of non-infringement of intellectual property rights of any third party.

Information

For further information on technology, delivery terms and conditions and prices, please contact the nearest Infineon Technologies Office (www.infineon.com).

Warnings

Due to technical requirements, components may contain dangerous substances. For information on the types in question, please contact the nearest Infineon Technologies Office.

The Infineon Technologies component described in this Data Sheet may be used in life-support devices or systems and/or automotive, aviation and aerospace applications or systems only with the express written approval of Infineon Technologies, if a failure of such components can reasonably be expected to cause the failure of that life-support automotive, aviation and aerospace device or system or to affect the safety or effectiveness of that device or system. Life support devices or systems are intended to be implanted in the human body or to support and/or maintain and sustain and/or protect human life. If they fail, it is reasonable to assume that the health of the user or other persons may be endangered.

Mouser Electronics

Authorized Distributor

Click to View Pricing, Inventory, Delivery & Lifecycle Information:

[Infineon:](#)

[IFX1963TBV](#)

Данный компонент на территории Российской Федерации

Вы можете приобрести в компании MosChip.

Для оперативного оформления запроса Вам необходимо перейти по данной ссылке:

<http://moschip.ru/get-element>

Вы можете разместить у нас заказ для любого Вашего проекта, будь то серийное производство или разработка единичного прибора.

В нашем ассортименте представлены ведущие мировые производители активных и пассивных электронных компонентов.

Нашей специализацией является поставка электронной компонентной базы двойного назначения, продукции таких производителей как XILINX, Intel (ex.ALTERA), Vicor, Microchip, Texas Instruments, Analog Devices, Mini-Circuits, Amphenol, Glenair.

Сотрудничество с глобальными дистрибьюторами электронных компонентов, предоставляет возможность заказывать и получать с международных складов практически любой перечень компонентов в оптимальные для Вас сроки.

На всех этапах разработки и производства наши партнеры могут получить квалифицированную поддержку опытных инженеров.

Система менеджмента качества компании отвечает требованиям в соответствии с ГОСТ Р ИСО 9001, ГОСТ РВ 0015-002 и ЭС РД 009

Офис по работе с юридическими лицами:

105318, г.Москва, ул.Щербаковская д.3, офис 1107, 1118, ДЦ «Щербаковский»

Телефон: +7 495 668-12-70 (многоканальный)

Факс: +7 495 668-12-70 (доб.304)

E-mail: info@moschip.ru

Skype отдела продаж:

moschip.ru

moschip.ru_4

moschip.ru_6

moschip.ru_9