

## Overview

The R46 series is constructed of metallized polypropylene film encapsulated with self-extinguishing resin in a box of material that meets the requirements of UL 94 V-0.

## Applications

For worldwide use in electromagnetic interference (EMI) suppression in across-the-line applications that require X2 safety classification. Intended for use in situations in which capacitor failure would not result in exposure to electric shock. Not for use in "series with mains" type applications.

## Benefits

- Approvals: ENEC, UL, cUL, CQC
- X2 CLASS (IEC 60384-14)
- Rated voltage: 275 VAC 50/60 Hz
- Capacitance range: 0.033 – 10 µF
- Lead spacing: 10.0 – 37.5 mm
- Capacitance tolerance: ±20%, ±10%
- Climatic category 40/110/56, IEC 60068-1
- Tape & Reel in accordance with IEC 60286-2
- RoHS compliant and lead-free terminations
- Operating temperature range of -40°C to +110°C
- 100% screening factory test at 2,200 VDC/1,500 VAC
- Self healing properties

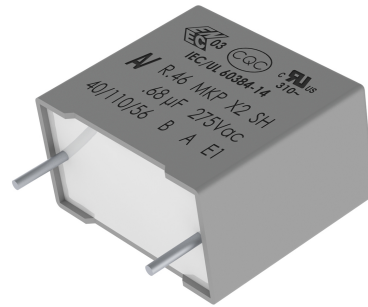

## Part Number System

| R46                          | K                   | I  | 3470   | 00                         | P0                   | M                     |
|------------------------------|---------------------|--|--|----------------------------|----------------------|-----------------------|
| Series                       | Rated Voltage (VAC) | Lead Spacing (mm)  | Capacitance Code (µF)  | Packaging                  | Internal Use         | Capacitance Tolerance |
| X2, Metallized Polypropylene | K = 275             | F = 10.0<br>I = 15.0<br>N = 22.5<br>R = 27.5<br>W = 37.5 | The last three digits represent significant figures.<br>The first digit specifies number of zeros to be added. | See Ordering Options Table | P0<br>P1<br>P2<br>P3 | K = ±10%<br>M = ±20%  |

## Ordering Options Table

| Lead Spacing Nominal (mm)               | Type of Leads and Packaging                | Lead Length (mm)                           | Lead and Packaging Code |
|---|--|--|-------------------------|
| 10<br>15<br>22.5                        | <b>Standard Lead and Packaging Options</b> |  |                         |
|   | Bulk (Bag) – Short Leads                   | 4 +2/-0                                    | 00                      |
|   | Ammo Pack                                  | H <sub>0</sub> = 18.5 ±0.5                 | DQ                      |
|   | <b>Other Lead and Packaging Options</b>    |  |                         |
|   | Tape & Reel (Large Reel)                   | H <sub>0</sub> = 18.5 ±0.5                 | CK                      |
|   | Bulk (Bag) – Short Leads                   | 2.7 +0.5/-0                                | JA                      |
|   | Bulk (Bag) – Short Leads                   | 3.5 +0.5/-0                                | JB                      |
|   | Bulk (Bag) – Short Leads                   | 4.0 +0.5/-0                                | JE                      |
|   | Bulk (Bag) – Short Leads                   | 3.2 +0.3/-0.2                              | JH                      |
|   | Bulk (Bag) – Long Leads                    | 18 ±1                                      | JM                      |
|   | Bulk (Bag) – Long Leads                    | 30 +5/-0                                   | 40                      |
|   | Bulk (Bag) – Long Leads                    | 25 +2/-1                                   | 50                      |
|   | Bulk (Bag) – Insulated Rigid Leads         | 30 +5/-0 (sp 8 ±2)                         | 51                      |
|   | Bulk (Bag) – Insulated Flexible Leads      | 150 ±5 (sp 8 ±2)                           | 52                      |
| 27.5                                    | <b>Standard Lead and Packaging Options</b> |  |                         |
|   | Bulk (Bag) – Short Leads                   | 4 +2/-0                                    | 00                      |
|   | Tape & Reel (Large Reel)                   | H <sub>0</sub> = 18.5 ±0.5                 | CK <sup>1</sup>         |
|   | <b>Other Lead and Packaging Options</b>    |  |                         |
|   | Bulk (Tray) – Short Leads                  | 2.7 +0.5/-0                                | JA                      |
|   | Bulk (Tray) – Short Leads                  | 3.5 +0.5/-0                                | JB                      |
|   | Bulk (Tray) – Short Leads                  | 4.0 +0.5/-0                                | JE                      |
|   | Bulk (Tray) – Short Leads                  | 3.2 +0.3/-0.2                              | JH                      |
|   | Bulk (Tray) – Long Leads                   | 18 ±1                                      | JM                      |
|   | Bulk (Tray) – Long Leads                   | 30 +5/-0                                   | 40                      |
|   | Bulk (Tray) – Long Leads                   | 25 +2/-1                                   | 50                      |
|   | Bulk (Bag) – Insulated Rigid Leads         | 30 +5/-0 (sp 8 ±2)                         | 51                      |
|   | Bulk (Bag) – Insulated Flexible Leads      | 150 ±5 (sp 8 ±2)                           | 52                      |
|   | 37.5                                       | <b>Standard Lead and Packaging Options</b> |                         |
| Bulk (Tray) – Short Leads               |  | 4 +2/-0                                    | 00                      |
| <b>Other Lead and Packaging Options</b> |  |  |                         |
| Bulk (Tray) – Short Leads               |  | 2.7 +0.5/-0                                | JA                      |
| Bulk (Tray) – Short Leads               |  | 3.5 +0.5/-0                                | JB                      |
| Bulk (Tray) – Short Leads               |  | 4.0 +0.5/-0                                | JE                      |
| Bulk (Tray) – Short Leads               |  | 3.2 +0.3/-0.2                              | JH                      |
| Bulk (Tray) – Long Leads                |  | 18 ±1                                      | JM                      |
| Bulk (Tray) – Long Leads                |  | 30 +5/-0                                   | 40                      |
| Bulk (Tray) – Long Leads                |  | 25 +2/-1                                   | 50                      |
| Bulk (Bag) – Insulated Rigid Leads      |  | 30 +5/-0 (sp 8 ±2)                         | 51                      |
| Bulk (Bag) – Insulated Flexible Leads   |  | 150 ±5 (sp 8 ±2)                           | 52                      |

<sup>1</sup> Not for all sizes, see "Packaging Quantities" table.

## Dimensions – Millimeters

### Loose

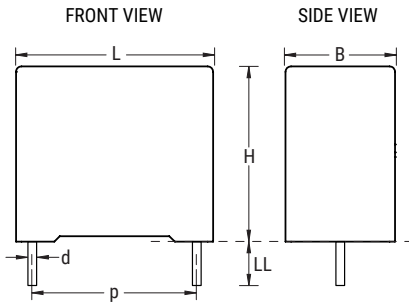

### Insulated Rigid Leads

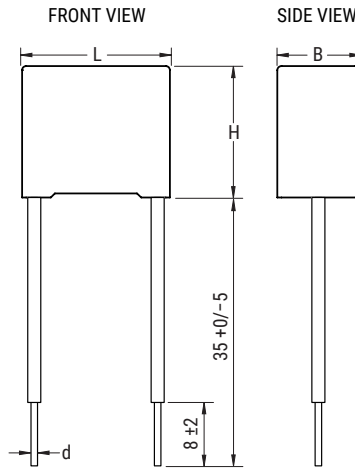

### Insulated Flexible Leads 0.5 mm<sup>2</sup>

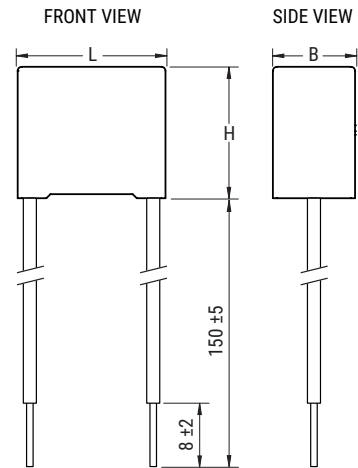

| p       |           | B       |           | H       |           | L       |           | d       |           |
|---------|-----------|---------|-----------|---------|-----------|---------|-----------|---------|-----------|
| Nominal | Tolerance | Nominal | Tolerance | Nominal | Tolerance | Nominal | Tolerance | Nominal | Tolerance |
| 10.0    | ±0.4      | 4.0     | +0.2/-0.5 | 9.0     | +0.1/-0.5 | 13.0    | +0.2/-0.5 | 0.6     | ±0.05     |
| 10.0    | ±0.4      | 5.0     | +0.2/-0.5 | 11.0    | +0.1/-0.5 | 13.0    | +0.2/-0.5 | 0.6     | ±0.05     |
| 10.0    | ±0.4      | 6.0     | +0.2/-0.5 | 12.0    | +0.1/-0.5 | 13.0    | +0.2/-0.5 | 0.6     | ±0.05     |
| 15.0    | ±0.4      | 5.0     | +0.2/-0.5 | 11.0    | +0.1/-0.5 | 18.0    | +0.3/-0.5 | 0.6     | ±0.05     |
| 15.0    | ±0.4      | 6.0     | +0.2/-0.5 | 12.0    | +0.1/-0.5 | 18.0    | +0.3/-0.5 | 0.6     | ±0.05     |
| 15.0    | ±0.4      | 6.0     | +0.2/-0.5 | 17.5    | +0.1/-0.5 | 18.0    | +0.3/-0.5 | 0.6     | ±0.05     |
| 15.0    | ±0.4      | 7.5     | +0.2/-0.5 | 13.5    | +0.1/-0.5 | 18.0    | +0.5/-0.5 | 0.6     | ±0.05     |
| 15.0    | ±0.4      | 7.5     | +0.2/-0.5 | 18.5    | +0.1/-0.5 | 18.0    | +0.5/-0.5 | 0.8     | ±0.05     |
| 15.0    | ±0.4      | 8.5     | +0.2/-0.5 | 14.5    | +0.1/-0.5 | 18.0    | +0.5/-0.5 | 0.6     | ±0.05     |
| 15.0    | ±0.4      | 9.0     | +0.2/-0.5 | 12.5    | +0.1/-0.5 | 18.0    | +0.5/-0.5 | 0.6     | ±0.05     |
| 15.0    | ±0.4      | 10.0    | +0.2/-0.5 | 16.0    | +0.1/-0.5 | 18.0    | +0.5/-0.5 | 0.8     | ±0.05     |
| 15.0    | ±0.4      | 11.0    | +0.2/-0.5 | 19.0    | +0.1/-0.5 | 18.0    | +0.5/-0.5 | 0.8     | ±0.05     |
| 22.5    | ±0.4      | 6.0     | +0.2/-0.5 | 15.0    | +0.1/-0.5 | 26.5    | +0.3/-0.5 | 0.8     | ±0.05     |
| 22.5    | ±0.4      | 7.0     | +0.2/-0.5 | 16.0    | +0.1/-0.5 | 26.5    | +0.3/-0.5 | 0.8     | ±0.05     |
| 22.5    | ±0.4      | 8.5     | +0.2/-0.5 | 17.0    | +0.1/-0.5 | 26.5    | +0.3/-0.5 | 0.8     | ±0.05     |
| 22.5    | ±0.4      | 10.0    | +0.2/-0.5 | 18.5    | +0.1/-0.5 | 26.5    | +0.3/-0.5 | 0.8     | ±0.05     |
| 22.5    | ±0.4      | 11.0    | +0.2/-0.5 | 20.0    | +0.1/-0.5 | 26.5    | +0.3/-0.5 | 0.8     | ±0.05     |
| 22.5    | ±0.4      | 13.0    | +0.2/-0.5 | 22.0    | +0.1/-0.5 | 26.5    | +0.3/-0.5 | 0.8     | ±0.05     |
| 27.5    | ±0.4      | 9.0     | +0.2/-0.7 | 17.0    | +0.1/-0.7 | 32.0    | +0.3/-0.7 | 0.8     | ±0.05     |
| 27.5    | ±0.4      | 11.0    | +0.2/-0.7 | 20.0    | +0.1/-0.7 | 32.0    | +0.3/-0.7 | 0.8     | ±0.05     |
| 27.5    | ±0.4      | 13.0    | +0.2/-0.7 | 22.0    | +0.1/-0.7 | 32.0    | +0.3/-0.7 | 0.8     | ±0.05     |
| 27.5    | ±0.4      | 14.0    | +0.2/-0.7 | 28.0    | +0.1/-0.7 | 32.0    | +0.3/-0.7 | 0.8     | ±0.05     |
| 27.5    | ±0.4      | 18.0    | +0.2/-0.7 | 33.0    | +0.1/-0.7 | 32.0    | +0.3/-0.7 | 0.8     | ±0.05     |
| 27.5    | ±0.4      | 22.0    | +0.2/-0.7 | 37.0    | +0.1/-0.7 | 32.0    | +0.3/-0.7 | 0.8     | ±0.05     |
| 37.5    | ±0.4      | 11.0    | +0.3/-0.7 | 22.0    | +0.1/-0.7 | 41.5    | +0.3/-0.7 | 1.0     | ±0.05     |
| 37.5    | ±0.4      | 13.0    | +0.3/-0.7 | 24.0    | +0.1/-0.7 | 41.5    | +0.3/-0.7 | 1.0     | ±0.05     |
| 37.5    | ±0.4      | 16.0    | +0.3/-0.7 | 28.5    | +0.1/-0.7 | 41.5    | +0.3/-0.7 | 1.0     | ±0.05     |
| 37.5    | ±0.4      | 19.0    | +0.3/-0.7 | 32.0    | +0.1/-0.7 | 41.5    | +0.3/-0.7 | 1.0     | ±0.05     |
| 37.5    | ±0.4      | 20.0    | +0.3/-0.7 | 40.0    | +0.1/-0.7 | 41.5    | +0.3/-0.7 | 1.0     | ±0.05     |

**Note: See Ordering Options Table for lead length (LL/H<sub>0</sub>) options.**

## Performance Characteristics

|                                     |   |   |   |                  |
|-------------------------------------|---|---|---|------------------|
| Dielectric                          | Polypropylene film  |   |   |                  |
| Plates                              | Metal layer deposited by evaporation under vacuum   |   |   |                  |
| Winding                             | Non-inductive type  |   |   |                  |
| Leads                               | Tinned wire   |   |   |                  |
| Protection                          | Plastic case, thermosetting resin filled. Box material is solvent resistant and flame retardant according to UL94.  |   |   |                  |
| Related Documents                   | IEC 60384-14, EN 60384-14   |   |   |                  |
| Rated Voltage $V_R$                 | 275 VAC (50/60 Hz), 560 VDC   |   |   |                  |
| Capacitance Range                   | 0.033 – 10 $\mu$ F  |   |   |                  |
| Capacitance Values                  | E6 series (IEC 60063) measured @ 1 kHz and +20 $\pm$ 1°C  |   |   |                  |
| Capacitance Tolerance               | $\pm$ 10%, $\pm$ 20%  |   |   |                  |
| Temperature Range                   | -40°C to +110°C   |   |   |                  |
| Climatic Category                   | 40/110/56 IEC 60068-1   |   |   |                  |
| Storage Conditions                  | Storage time: $\leq$ 24 months from the date marked on the label package  |   |   |                  |
|                                     | Average relative humidity per year $\leq$ 70%   |   |   |                  |
|                                     | RH $\leq$ 85% for 30 days randomly distributed throughout the year  |   |   |                  |
|                                     | Dew is absent   |   |   |                  |
|                                     | Temperature: -40 to 80°C (see "Maximum Humidity in Storage Conditions" graph below)   |   |   |                  |
| Approvals                           | ENEC, UL, cUL, CQC  |   |   |                  |
| Dissipation Factor ( $\tan\delta$ ) | $\leq$ 0.1% (0.06%*) at 1 kHz, +25°C $\pm$ 5°C (* typical value)  |   |   |                  |
| Test Voltage Between Terminals      | The 100% screening factory test is carried out at 2,200 VDC/1,500 VAC.<br>The voltage level is selected to meet the requirements in applicable equipment standards.<br>All electrical characteristics are checked after the test. This test cannot be repeated, as there is a risk of damaging the capacitor. KEMET is not liable in such cases for any failures. |   |   |                  |
| Insulation Resistance               | Measured at +25°C $\pm$ 5°C, according to IEC 60384-2   |   |   |                  |
|                                     | Minimum Values Between Terminals  |   |   |                  |
|                                     | Voltage Charge  | Voltage Charge Time   | C $\leq$ 0.33 $\mu$ F   | C > 0.33 $\mu$ F |
| 100 VDC                             | 1 minute  | $\geq$ 1 $\cdot$ 10 <sup>5</sup> M $\Omega$<br>( $\geq$ 5 $\cdot$ 10 <sup>5</sup> M $\Omega$ )* | $\geq$ 30,000 M $\Omega$ $\cdot$ $\mu$ F<br>( $\geq$ 150,000 M $\Omega$ $\cdot$ $\mu$ F)* |                  |
| In DC Applications                  | Recommended voltage $\leq$ 560 VDC  |   |   |                  |

## Performance Characteristics cont.

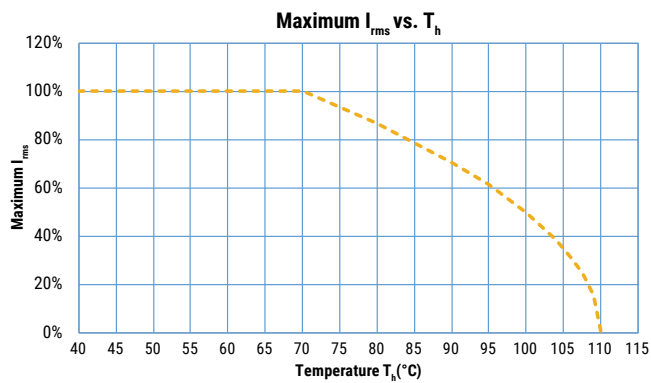
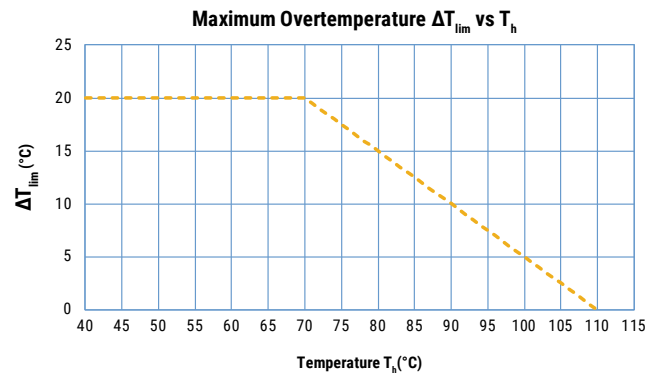
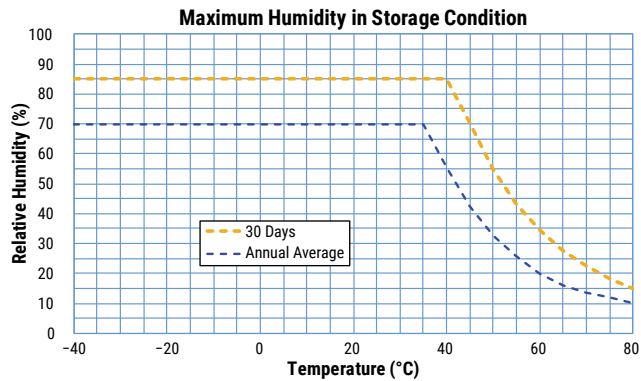

$T_h$  is the maximum ambient temperature surrounding the capacitor or hottest contact point (e.g. tracks), whichever is higher, in the worst operation conditions in °C.

## Impedance Graph

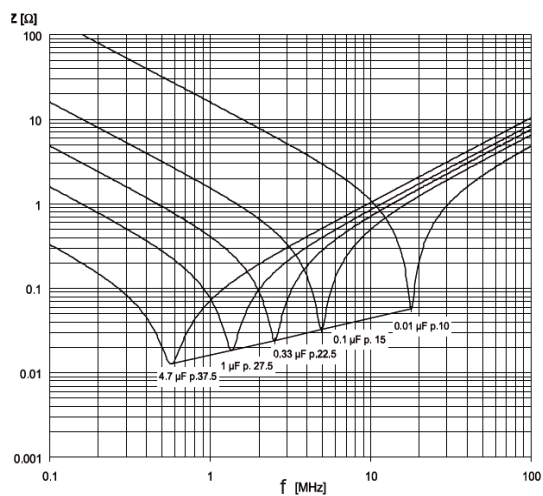

## Maximum Voltage ( $V_{rms}$ ) Versus Frequency (Sinusoidal Waveform/ $Th \leq 70^\circ C$ )

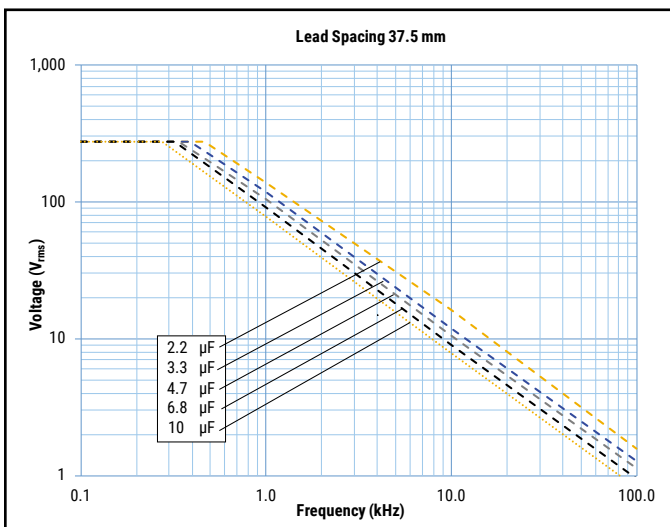
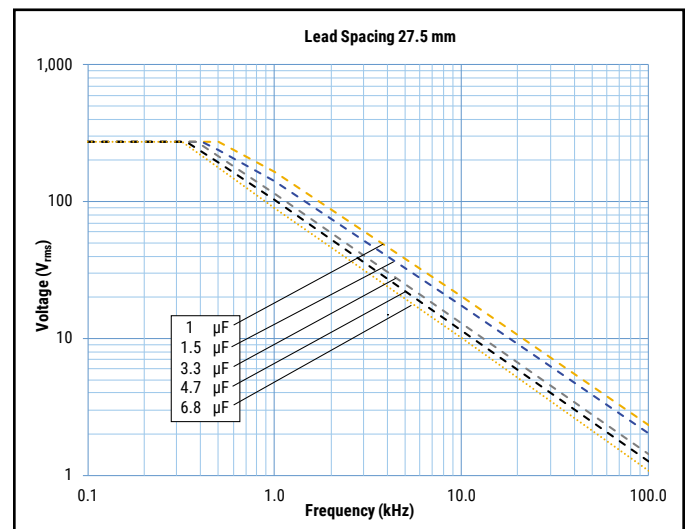
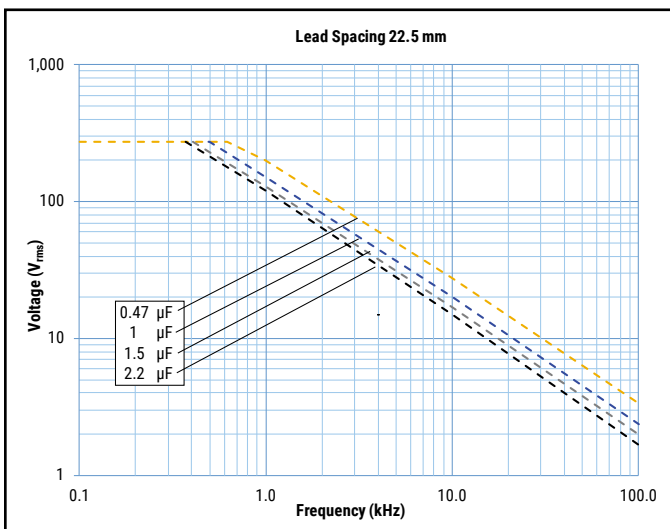
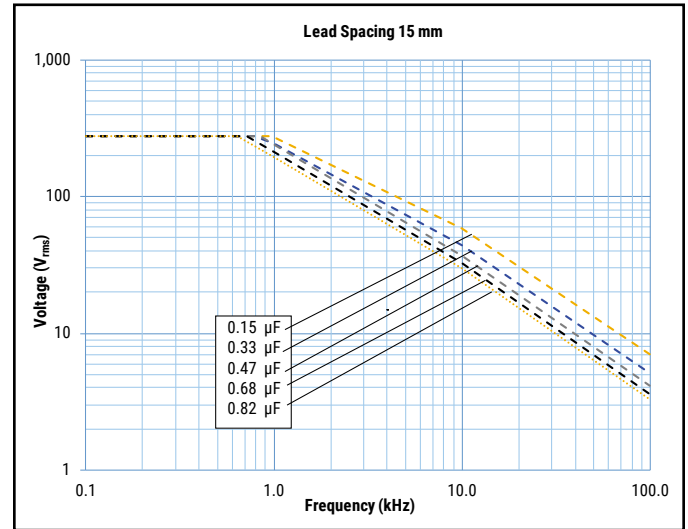
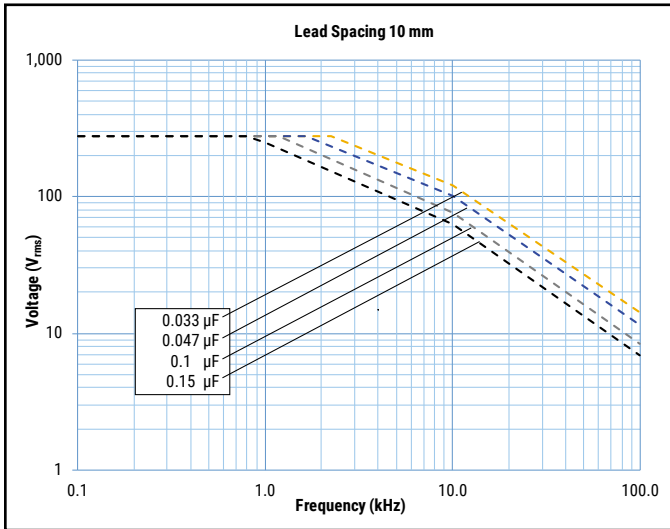

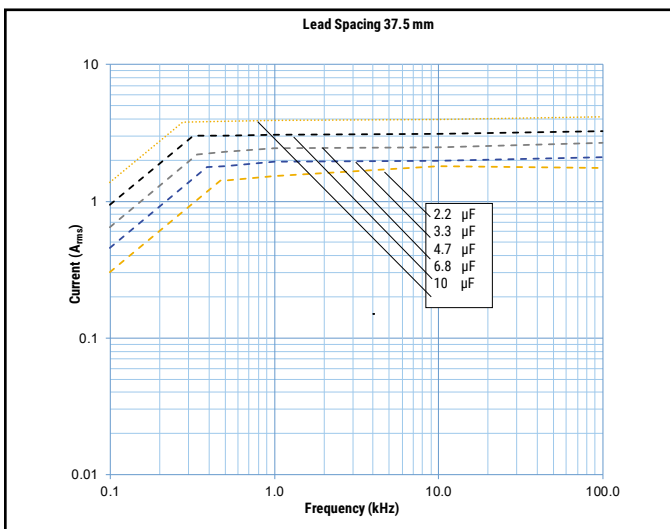
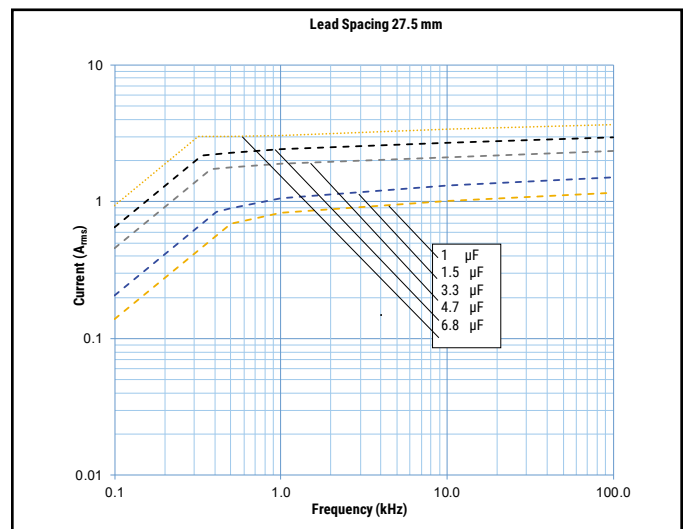
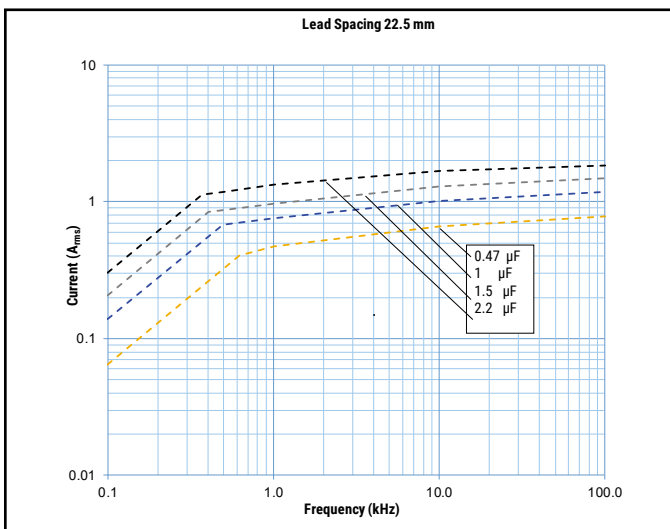
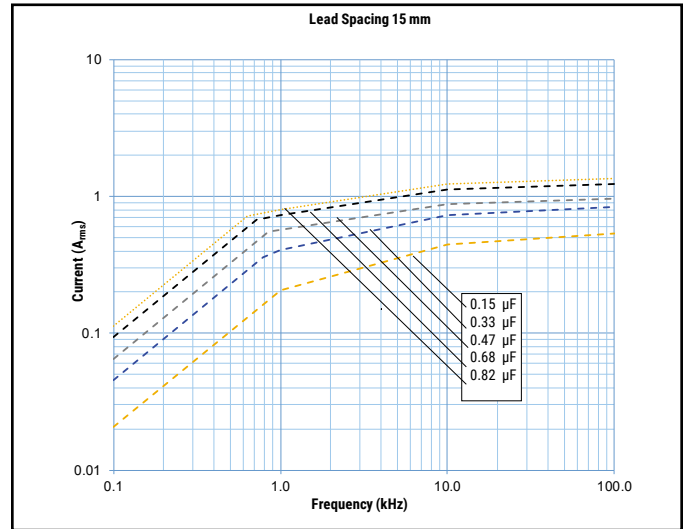
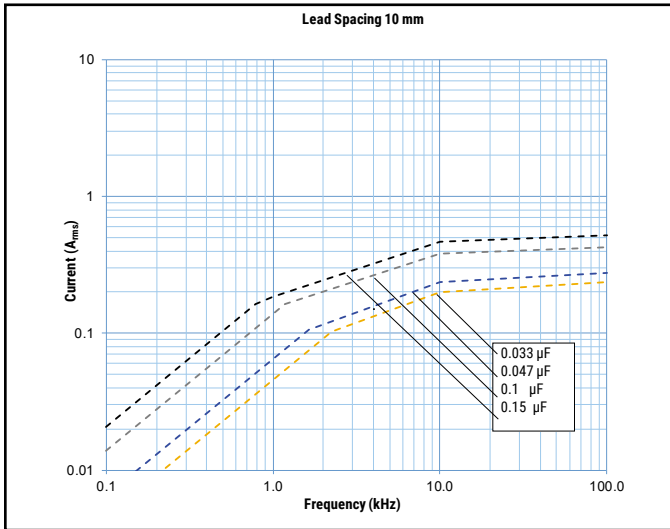

## Maximum Current ( $I_{rms}$ ) Versus Frequency (Sinusoidal Waveform/ $Th \leq 70^\circ C$ )



## Environmental Test Data

| Test                   | IEC Publication         | Procedure   |
|------------------------|-------------------------|---|
| Endurance              | EN/IEC 60384-14         | 1.25 x V <sub>R</sub> VAC 50 Hz, once every hour increase to 1,000 VAC for 0.1 second, 1,000 hours at upper rated temperature |
| Vibration              | IEC 60068-2-6 Test Fc   | 3 directions at 2 hours each 10 – 55 Hz at 0.75 mm or 98 m/s <sup>2</sup>   |
| Bump                   | IEC 60068-2-29 Test Eb  | 1,000 bumps at 390 m/s <sup>2</sup>   |
| Change of Temperature  | IEC 60068-2-14 Test Na  | Upper and lower rated temperature 5 cycles  |
| Active Flammability    | IEC 60384-14            | V <sub>R</sub> + 20 surge pulses at 2.5 kV (pulse every 5 seconds)  |
| Passive Flammability   | IEC 60384-14            | IEC 60384-1, IEC 60695-11-5 Needle flame test   |
| Damp Heat Steady State | IEC 60068-2-78 Test Cab | +40°C and 93% RH, 56 days   |

## Approvals

| Mark  | Specification                                     | File Number  |
|---|---|--|
|   | EN/IEC 60384-14                                   | V4413  |
|  | UL 60384-14 and<br>CAN/CSA E60384-14<br>(310 VAC) | E97797   |
|  | IEC 60384-14                                      | CQC08001026549<br>CQC11001060118<br>CQC13001087757<br>CQC14001116028<br>CQC13001101266<br>CQC14001116000 |

## Environmental Compliance

All KEMET EMI capacitors are RoHS compliant.





**Table 1 – Ratings & Part Number Reference**

| Capacitance Value (µF) | Dimensions in mm |        |        | Lead Spacing (p) | dV/dt (V/µs) | New KEMET Part Number | Legacy Part Number |
|------------------------|------------------|--------|--------|------------------|--------------|-----------------------|--------------------|
|                        | B                | H      | L      |                  |              |                       |                    |
| 0.033                  | 4.0              | 9.0    | 13.0   | 10.0             | 500          | 46KF2330(1)P0(2)      | R46KF2330(1)P0(2)  |
| 0.047                  | 4.0              | 9.0    | 13.0   | 10.0             | 500          | 46KF2470(1)P0(2)      | R46KF2470(1)P0(2)  |
| 0.068                  | 5.0              | 11.0   | 13.0   | 10.0             | 500          | 46KF2680(1)P0(2)      | R46KF2680(1)P0(2)  |
| 0.10                   | 5.0              | 11.0   | 13.0   | 10.0             | 500          | 46KF3100(1)P1(3)      | R46KF3100(1)P1(3)  |
| 0.10                   | 6.0              | 12.0   | 13.0   | 10.0             | 500          | 46KF3100(1)P0(2)      | R46KF3100(1)P0(2)  |
| 0.15                   | 6.0              | 12.0   | 13.0   | 10.0             | 500          | 46KF3150(1)P0(3)      | R46KF3150(1)P0(3)  |
| 0.15                   | 5.0              | 11.0   | 18.0   | 15.0             | 400          | 46KI3150(1)P0(2)      | R46KI3150(1)P0(2)  |
| 0.22                   | 6.0              | 12.0   | 18.0   | 15.0             | 400          | 46KI3220(1)P0(2)      | R46KI3220(1)P0(2)  |
| 0.33                   | 7.5              | 13.5   | 18.0   | 15.0             | 400          | 46KI3330(1)P0(2)      | R46KI3330(1)P0(2)  |
| 0.33                   | 9.0              | 12.5   | 18.0   | 15.0             | 400          | 46KI3330(1)P1(2)      | R46KI3330(1)P1(2)  |
| 0.33                   | 6.0              | 17.5   | 18.0   | 15.0             | 400          | 46KI3330(1)P2(2)      | R46KI3330(1)P2(2)  |
| 0.47                   | 8.5              | 14.5   | 18.0   | 15.0             | 400          | 46KI3470(1)P0(2)      | R46KI3470(1)P0(2)  |
| 0.47                   | 9.0              | 12.5   | 18.0   | 15.0             | 400          | 46KI3470(1)P1(3)      | R46KI3470(1)P1(3)  |
| 0.47                   | 6.0              | 17.5   | 18.0   | 15.0             | 400          | 46KI3470(1)P2(3)      | R46KI3470(1)P2(3)  |
| 0.47                   | 7.5              | 18.5   | 18.0   | 15.0             | 400          | 46KI3470(1)P3(2)      | R46KI3470(1)P3(2)  |
| 0.68                   | 10.0             | 16.0   | 18.0   | 15.0             | 400          | 46KI3680(1)P1(3)      | R46KI3680(1)P1(3)  |
| 0.68                   | 11.0             | 19.0   | 18.0   | 15.0             | 400          | 46KI3680(1)P0(2)      | R46KI3680(1)P0(2)  |
| 0.82                   | 11.0             | 19.0   | 18.0   | 15.0             | 400          | 46KI3820(1)P0(3)      | R46KI3820(1)P0(3)  |
| 0.47                   | 6.0              | 15.0   | 26.5   | 22.5             | 200          | 46KN3470(1)P1(2)      | R46KN3470(1)P1(2)  |
| 0.56                   | 6.0              | 15.0   | 26.5   | 22.5             | 200          | 46KN3560(1)P1(3)      | R46KN3560(1)P1(3)  |
| 0.56                   | 7.0              | 16.0   | 26.5   | 22.5             | 200          | 46KN3560(1)P0(2)      | R46KN3560(1)P0(2)  |
| 0.68                   | 7.0              | 16.0   | 26.5   | 22.5             | 200          | 46KN3680(1)P0(2)      | R46KN3680(1)P0(2)  |
| 1.0                    | 8.5              | 17.0   | 26.5   | 22.5             | 200          | 46KN4100(1)P1(3)      | R46KN4100(1)P1(3)  |
| 1.0                    | 10.0             | 18.5   | 26.5   | 22.5             | 200          | 46KN4100(1)P0(2)      | R46KN4100(1)P0(2)  |
| 1.5                    | 10.0             | 18.5   | 26.5   | 22.5             | 200          | 46KN4150(1)P1(3)      | R46KN4150(1)P1(3)  |
| 1.5                    | 11.0             | 20.0   | 26.5   | 22.5             | 200          | 46KN4150(1)P0(2)      | R46KN4150(1)P0(2)  |
| 2.2                    | 13.0             | 22.0   | 26.5   | 22.5             | 200          | 46KN4220(1)P0(3)      | R46KN4220(1)P0(3)  |
| 1.0                    | 9.0              | 17.0   | 32.0   | 27.5             | 150          | 46KR4100(1)P0(2)      | R46KR4100(1)P0(2)  |
| 1.5                    | 11.0             | 20.0   | 32.0   | 27.5             | 150          | 46KR4150(1)P0(2)      | R46KR4150(1)P0(2)  |
| 2.2                    | 13.0             | 22.0   | 32.0   | 27.5             | 150          | 46KR4220(1)P0(2)      | R46KR4220(1)P0(2)  |
| 3.3                    | 14.0             | 28.0   | 32.0   | 27.5             | 150          | 46KR4330(1)P0(2)      | R46KR4330(1)P0(2)  |
| 4.7                    | 14.0             | 28.0   | 32.0   | 27.5             | 150          | 46KR4470(1)P1(3)      | R46KR4470(1)P1(3)  |
| 4.7                    | 18.0             | 33.0   | 32.0   | 27.5             | 150          | 46KR4470(1)P0(2)      | R46KR4470(1)P0(2)  |
| 6.8                    | 22.0             | 37.0   | 32.0   | 27.5             | 150          | 46KR4680(1)P0(2)      | R46KR4680(1)P0(2)  |
| 2.2                    | 11.0             | 22.0   | 41.5   | 37.5             | 100          | 46KW4220(1)P0(2)      | R46KW4220(1)P0(2)  |
| 3.3                    | 13.0             | 24.0   | 41.5   | 37.5             | 100          | 46KW4330(1)P0(2)      | R46KW4330(1)P0(2)  |
| 4.7                    | 16.0             | 28.5   | 41.5   | 37.5             | 100          | 46KW4470(1)P0(2)      | R46KW4470(1)P0(2)  |
| 6.8                    | 19.0             | 32.0   | 41.5   | 37.5             | 100          | 46KW4680(1)P0(2)      | R46KW4680(1)P0(2)  |
| 10.0                   | 20.0             | 40.0   | 41.5   | 37.5             | 100          | 46KW5100(1)P0(2)      | R46KW5100(1)P0(2)  |
| Capacitance Value (µF) | B (mm)           | H (mm) | L (mm) | Lead Spacing (p) | dV/dt (V/µs) | New KEMET Part Number | Legacy Part Number |

(1) Insert lead and packaging code. See Ordering Options Table for available options.

(2) M = ±20%, K = ±10%

(3) M = ±20% (only available tolerance).

## Soldering Process

The implementation of the RoHS directive has resulted in the selection of SnAuCu (SAC) alloys or SnCu alloys as primary solder material. This has increased the liquidus temperature from 183°C for SnPb eutectic alloys to 217 – 221°C for the new alloys. As a result, the heat stress to the components, even in wave soldering, has increased considerably due to higher pre-heat and wave temperatures. Polypropylene capacitors are especially sensitive to heat (the melting point of polypropylene is 160 – 170°C). Wave soldering can be destructive, especially for mechanically small polypropylene capacitors (with lead spacing of 5 – 15 mm). Great care must be taken during soldering. The recommended solder profiles from KEMET should be used. Consult KEMET with any questions. In general, the wave soldering curve from IEC Publication 61760-1 Edition 2 serves as a solid guideline for successful soldering. See Figure 1.

Reflow soldering is not recommended for through-hole film capacitors. Exposing capacitors to a soldering profile in excess of the above-recommended limits may result to degradation of or permanent damage to the capacitors.

Do not place the polypropylene capacitor through an adhesive curing oven to cure resin for surface mount components. Insert through-hole parts after curing surface mount parts. Consult KEMET to discuss the actual temperature profile in the oven, if through-hole components must pass through the adhesive curing process. A maximum two soldering cycles is recommended. Allow time for the capacitor surface temperature to return to normal temperature before performing the second soldering cycle.

### Manual Soldering Recommendations

Following is the recommendation for manual soldering with a soldering iron.

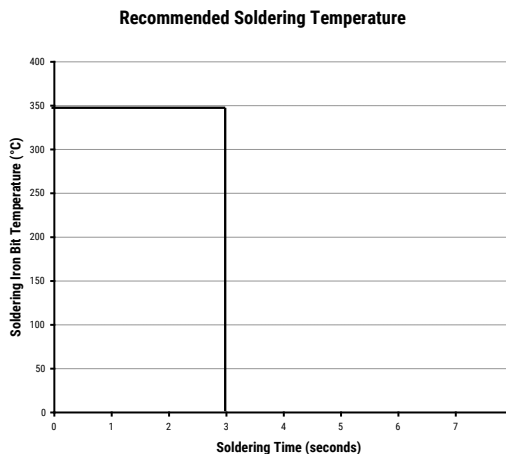

The soldering iron tip temperature should be set at 350°C (+10°C maximum), with the soldering duration not to exceed more than 3 seconds.

### Wave Soldering Recommendations

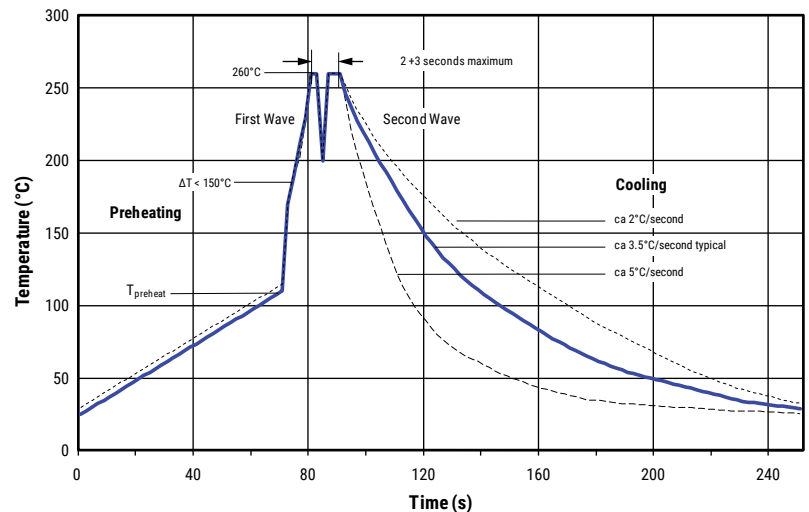

## Soldering Process cont.

### Wave Soldering Recommendations cont.

1. The table indicates the maximum set-up temperature of the soldering process.

| Dielectric Film Material | Maximum Preheat Temperature  |                           | Maximum Peak Soldering Temperature |                           |
|--------------------------|------------------------------|---------------------------|------------------------------------|---------------------------|
|                          | Capacitor Pitch $\leq 15$ mm | Capacitor Pitch $> 15$ mm | Capacitor Pitch $\leq 15$ mm       | Capacitor Pitch $> 15$ mm |
| Polyester                | 130°C                        | 130°C                     | 270°C                              | 270°C                     |
| Polypropylene            | 110°C                        | 130°C                     | 260°C                              | 270°C                     |
| Paper                    | 130°C                        | 140°C                     | 270°C                              | 270°C                     |
| Polyphenylene Sulphide   | 150°C                        | 160°C                     | 270°C                              | 270°C                     |

2. The maximum temperature measured inside the capacitor: set the temperature so that the maximum temperature inside the element is below the limit.

| Dielectric Film Material | Maximum Temperature Measured Inside the Element |
|--------------------------|---|
| Polyester                | 160°C   |
| Polypropylene            | 110°C   |
| Paper                    | 160°C   |
| Polyphenylene Sulphide   | 160°C   |

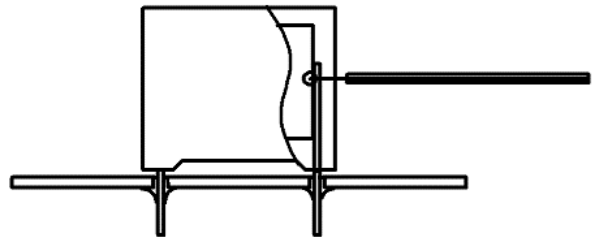

*Temperature monitored inside the capacitor.*

### Selective Soldering Recommendations

Selective dip soldering is a variation of reflow soldering. In this method, the printed circuit board with through-hole components to be soldered is preheated and transported over the solder bath as it is in normal flow soldering, without touching the solder. When the board is over the bath, it is stopped. Pre-designed solder pots are lifted from the bath with molten solder, only at the places of the selected components, and pressed against the lower surface of the board to solder the components.

The temperature profile for selective soldering is similar to the double wave flow soldering outlined in this document.

**However, instead of two baths, there is only one with a time from 3 – 10 seconds.** In selective soldering, the risk of overheating is greater than in double wave flow soldering, and great care must be taken so that the parts do not overheat.

## Construction

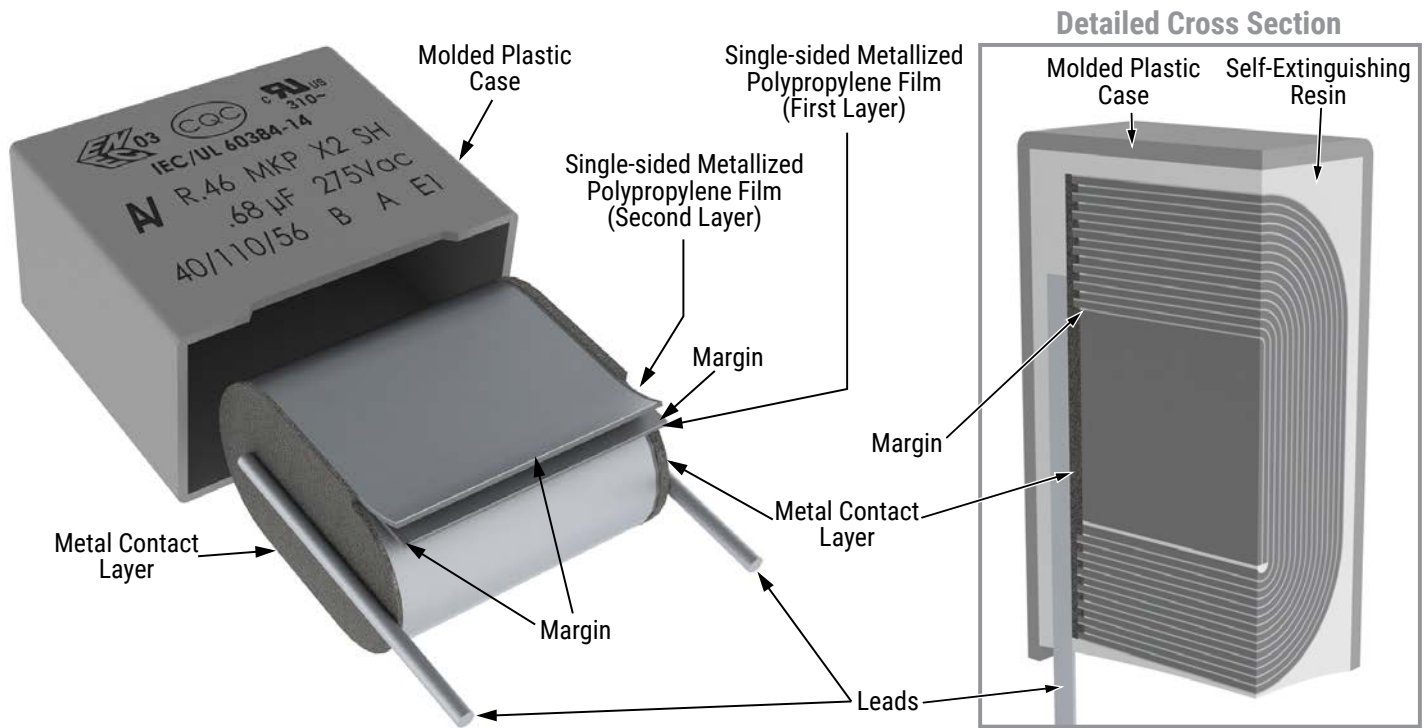

## Winding Scheme

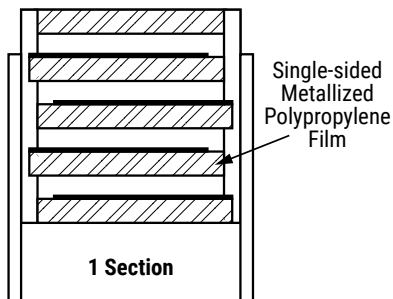

## Marking

### Lead Spacing 10 mm

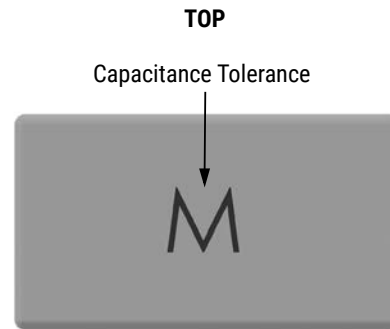
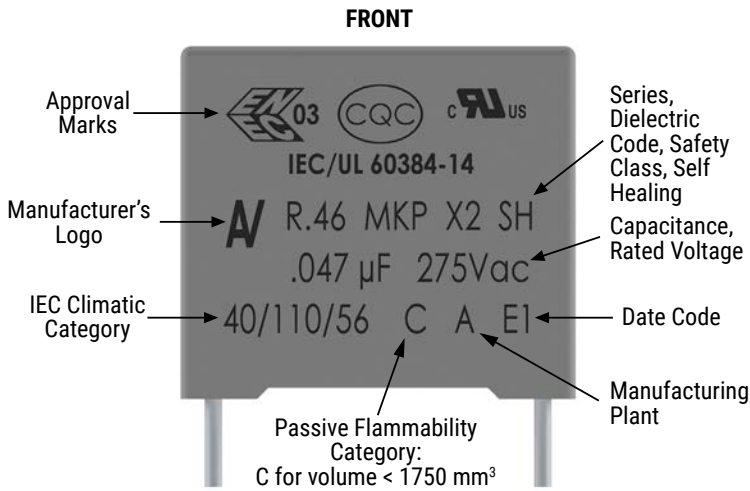

*NOTE: Hot imprinting with or without color or ink jet or laser marking*

### Lead Spacing 15 mm, 22.5 mm, and 27.5 mm

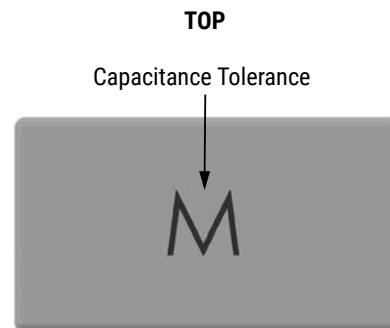
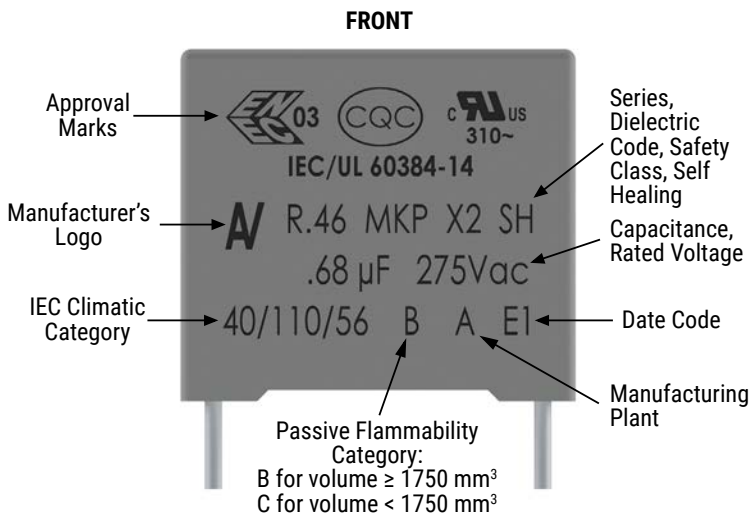

*NOTE: Hot imprinting with or without color or ink jet or laser marking*

## Marking cont.

Lead Spacing 22.5 and 27.5 mm (alternatives\*) and 37.5 mm

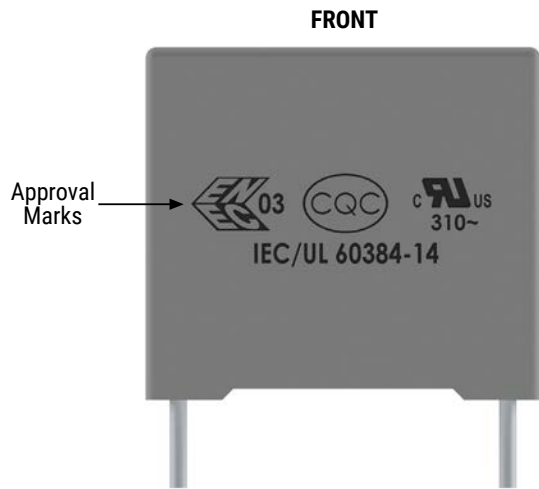

*\*Differences are caused by technology (clichee, laser, or ink) and production line.*

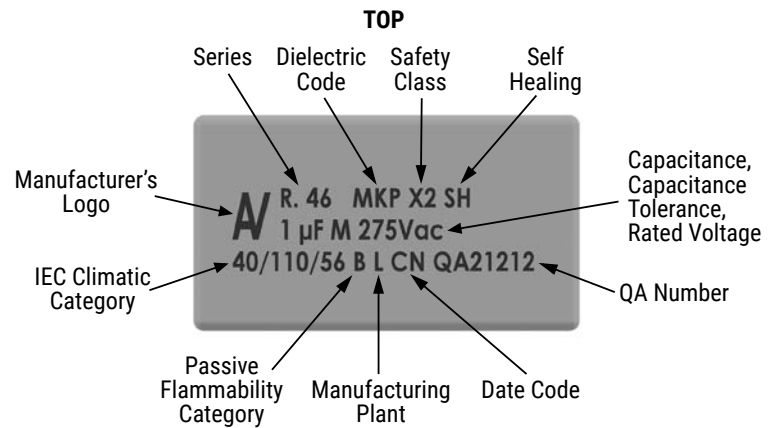

*NOTE: Hot imprinting with or without color or ink jet or laser marking*

### Manufacturing Date Code (IEC-60062)

Y = Year, Z = Month

| Year | Code | Month     | Code |
|------|------|-----------|------|
| 2000 | M    | January   | 1    |
| 2001 | N    | February  | 2    |
| 2002 | P    | March     | 3    |
| 2003 | R    | April     | 4    |
| 2004 | S    | May       | 5    |
| 2005 | T    | June      | 6    |
| 2006 | U    | July      | 7    |
| 2007 | V    | August    | 8    |
| 2008 | W    | September | 9    |
| 2009 | X    | October   | 0    |
| 2010 | A    | November  | N    |
| 2011 | B    | December  | D    |
| 2012 | C    |           |      |
| 2013 | D    |           |      |
| 2014 | E    |           |      |
| 2015 | F    |           |      |
| 2016 | H    |           |      |
| 2017 | J    |           |      |
| 2018 | K    |           |      |
| 2019 | L    |           |      |
| 2020 | M    |           |      |

## Packaging Quantities

| Lead Spacing (mm) | Thickness (mm) | Height (mm) | Length (mm) | Bulk Short Leads | Bulk Long Leads | Standard Reel<br>ø 355 mm | Large Reel<br>ø 500 mm | Ammo Taped |
|-------------------|----------------|-------------|-------------|------------------|-----------------|---------------------------|------------------------|------------|
| 10                | 4              | 9           | 13          | 2,000            | 1,800           | 750                       | 1,500                  | 1,000      |
|                   | 5              | 11          | 13          | 1,300            | 1,500           | 600                       | 1,250                  | 800        |
|                   | 6              | 12          | 13          | 1,000            | 1,200           | 500                       | 1,000                  | 680        |
| 15                | 5              | 11          | 18          | 2,000            | 1,000           | 600                       | 1,250                  | 800        |
|                   | 6              | 12          | 18          | 1,750            | 900             | 500                       | 1,000                  | 680        |
|                   | 6              | 17.5        | 18          | 1,000            | 700             | 500                       | 1,000                  | 680        |
|                   | 7.5            | 13.5        | 18          | 1,000            | 700             | 350                       | 800                    | 500        |
|                   | 7.5            | 18.5        | 18          | 900              | 500             | -                         | 800                    | 500        |
|                   | 8.5            | 14.5        | 18          | 1,000            | 500             | 300                       | 700                    | 440        |
|                   | 9              | 12.5        | 18          | 1,000            | 520             | 270                       | 650                    | 410        |
|                   | 10             | 16          | 18          | 750              | 500             | 300                       | 600                    | 380        |
|                   | 11             | 19          | 18          | 450              | 350             | -                         | 500                    | 340        |
| 22.5              | 6              | 15          | 26.5        | 805              | 500             | -                         | 700                    | 464        |
|                   | 7              | 16          | 26.5        | 700              | 500             | -                         | 550                    | 380        |
|                   | 8.5            | 17          | 26.5        | 468              | 300             | -                         | 450                    | 280        |
|                   | 10             | 18.5        | 26.5        | 396              | 300             | -                         | 350                    | 235        |
|                   | 11             | 20          | 26.5        | 360              | 250             | -                         | 350                    | 217        |
|                   | 13             | 22          | 26.5        | 300              | 200             | -                         | 300                    | -          |
| 27.5              | 9              | 17          | 32          | 816              | 408             | -                         | 450                    | -          |
|                   | 11             | 20          | 32          | 560              | 336             | -                         | 350                    | -          |
|                   | 13             | 22          | 32          | 480              | 288             | -                         | 300                    | -          |
|                   | 14             | 28          | 32          | 352              | 176             | -                         | -                      | -          |
|                   | 18             | 33          | 32          | 256              | 128             | -                         | -                      | -          |
|                   | 22             | 37          | 32          | 168              | 112             | -                         | -                      | -          |
|                   | 22             | 37          | 32          | 168              | 112             | -                         | -                      | -          |
| 37.5              | 11             | 22          | 41.5        | 420              | 252             | -                         | -                      | -          |
|                   | 13             | 24          | 41.5        | 360              | 216             | -                         | -                      | -          |
|                   | 16             | 28.5        | 41.5        | 216              | 108             | -                         | -                      | -          |
|                   | 19             | 32          | 41.5        | 192              | 96              | -                         | -                      | -          |
|                   | 20             | 40          | 41.5        | 126              | 84              | -                         | -                      | -          |

## Lead Taping & Packaging (IEC 60286-2)

**Figure 1**  
Lead Spacing 10 mm

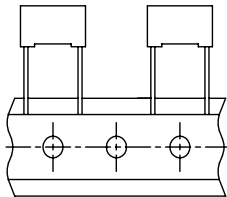

**Figure 2**  
Lead Spacing 15 mm

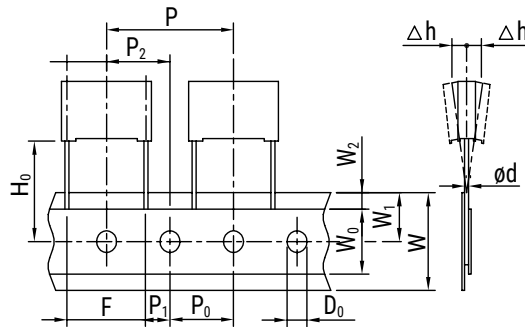

**Figure 3**  
Lead Spacing 22.5 – 27.5 mm

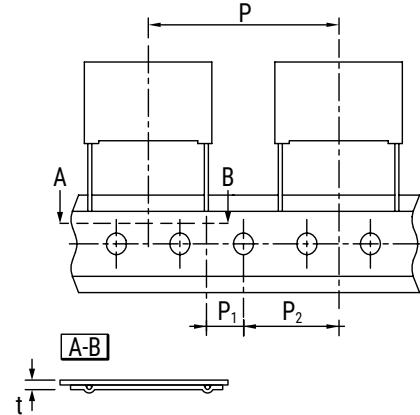

## Taping Specification

| Description                          | Symbol              | Dimensions (mm) |              |                |                |           | Tol. |
|--------------------------------------|---------------------|-----------------|--------------|----------------|----------------|-----------|------|
|                                      |                     | Lead Space      |              |                |                |           |      |
|                                      |                     | 10<br>Fig. 1    | 15<br>Fig. 2 | 22.5<br>Fig. 3 | 27.5<br>Fig. 3 |           |      |
| Lead wire diameter                   | d                   | 0.6             | 0.6–0.8      | 0.8            | 0.8            | ±0.05     |      |
| Taping lead space                    | P                   | 25.4            | 25.4         | 38.1           | 38.1           | ±1        |      |
| Feed hole lead space *               | P <sub>0</sub>      | 12.7            | 12.7         | 12.7           | 12.7           | ±0.2 **   |      |
| Centering of the lead wire           | P <sub>1</sub>      | 7.7             | 5.2          | 7.8            | 5.3            | ±0.7      |      |
| Centering of the body                | P <sub>2</sub>      | 12.7            | 12.7         | 19.05          | 19.05          | ±1.3      |      |
| Lead spacing (pitch) ***             | F                   | 10              | 15           | 22.5           | 27.5           | +0.6/-0.1 |      |
| Component alignment                  | Δh                  | 0               | 0            | 0              | 0              | ±2        |      |
| Height of component from tape center | H <sub>0</sub> **** | 18.5            | 18.5         | 18.5           | 18.5           | ±0.5      |      |
| Carrier tape width                   | W                   | 18              | 18           | 18             | 18             | +1/-0.5   |      |
| Hold down tape width                 | W <sub>0</sub>      | 9               | 10           | 10             | 10             | Minimum   |      |
| Hole position                        | W <sub>1</sub>      | 9               | 9            | 9              | 9              | ±0.5      |      |
| Hold down tape position              | W <sub>2</sub>      | 3               | 3            | 3              | 3              | Maximum   |      |
| Feed hole diameter                   | D <sub>0</sub>      | 4               | 4            | 4              | 4              | ±0.2      |      |
| Total tape thickness                 | t                   | 0.7             | 0.7          | 0.7            | 0.7            | ±0.2      |      |

\* 15 mm also available

\*\* Maximum of 1 mm on 20 lead spaces

\*\*\* Pitches 15 mm and 10 mm taped to 7.5 mm (crimped leads) available upon request

\*\*\*\* H<sub>0</sub> = 16.5 mm is available upon request



## Lead Taping & Packaging (IEC 60286-2) cont.

### Ammo Specifications

| Dimensions (mm) |     |    |
|-----------------|-----|----|
| H               | W   | T  |
| 360             | 340 | 59 |

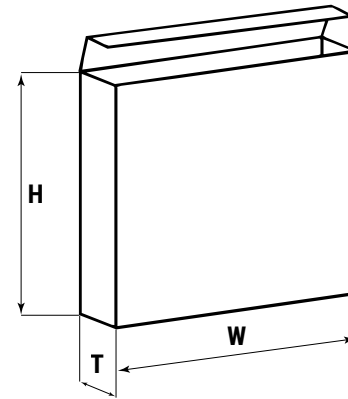

### Reel Specifications

| Reel Size | Dimensions (mm) |    |            |
|-----------|-----------------|----|------------|
|           | D               | H  | W          |
| Standard  | 355             | 30 | 55 Maximum |
| Large     | 500             | 25 |            |

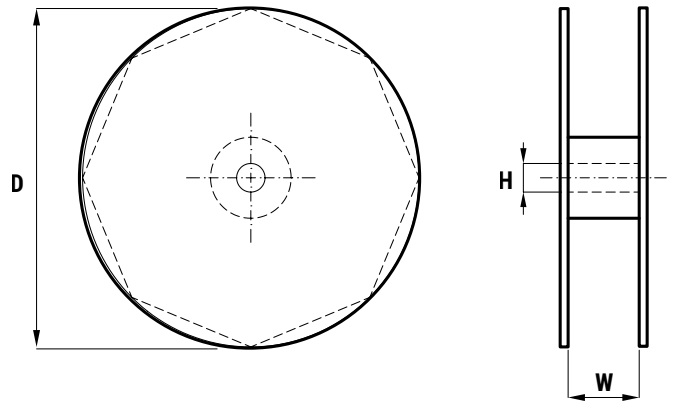

## KEMET Electronics Corporation Sales Offices

For a complete list of our global sales offices, please visit [www.kemet.com/sales](http://www.kemet.com/sales).

---

### Disclaimer

All product specifications, statements, information and data (collectively, the "Information") in this datasheet are subject to change. The customer is responsible for checking and verifying the extent to which the Information contained in this publication is applicable to an order at the time the order is placed. All Information given herein is believed to be accurate and reliable, but it is presented without guarantee, warranty, or responsibility of any kind, expressed or implied.

Statements of suitability for certain applications are based on KEMET Electronics Corporation's ("KEMET") knowledge of typical operating conditions for such applications, but are not intended to constitute – and KEMET specifically disclaims – any warranty concerning suitability for a specific customer application or use. The Information is intended for use only by customers who have the requisite experience and capability to determine the correct products for their application. Any technical advice inferred from this Information or otherwise provided by KEMET with reference to the use of KEMET's products is given gratis, and KEMET assumes no obligation or liability for the advice given or results obtained.

Although KEMET designs and manufactures its products to the most stringent quality and safety standards, given the current state of the art, isolated component failures may still occur. Accordingly, customer applications which require a high degree of reliability or safety should employ suitable designs or other safeguards (such as installation of protective circuitry or redundancies) in order to ensure that the failure of an electrical component does not result in a risk of personal injury or property damage.

Although all product-related warnings, cautions and notes must be observed, the customer should not assume that all safety measures are indicated or that other measures may not be required.

*KEMET is a registered trademark of KEMET Electronics Corporation.*

## Данный компонент на территории Российской Федерации

### Вы можете приобрести в компании MosChip.

Для оперативного оформления запроса Вам необходимо перейти по данной ссылке:

<http://moschip.ru/get-element>

Вы можете разместить у нас заказ для любого Вашего проекта, будь то серийное производство или разработка единичного прибора.

В нашем ассортименте представлены ведущие мировые производители активных и пассивных электронных компонентов.

Нашей специализацией является поставка электронной компонентной базы двойного назначения, продукции таких производителей как XILINX, Intel (ex.ALTERA), Vicor, Microchip, Texas Instruments, Analog Devices, Mini-Circuits, Amphenol, Glenair.

Сотрудничество с глобальными дистрибьюторами электронных компонентов, предоставляет возможность заказывать и получать с международных складов практически любой перечень компонентов в оптимальные для Вас сроки.

На всех этапах разработки и производства наши партнеры могут получить квалифицированную поддержку опытных инженеров.

Система менеджмента качества компании отвечает требованиям в соответствии с ГОСТ Р ИСО 9001, ГОСТ РВ 0015-002 и ЭС РД 009

### Офис по работе с юридическими лицами:

105318, г.Москва, ул.Щербаковская д.3, офис 1107, 1118, ДЦ «Щербаковский»

Телефон: +7 495 668-12-70 (многоканальный)

Факс: +7 495 668-12-70 (доб.304)

E-mail: [info@moschip.ru](mailto:info@moschip.ru)

Skype отдела продаж:

moschip.ru

moschip.ru\_4

moschip.ru\_6

moschip.ru\_9