

EVALUATION KIT  
AVAILABLE

# 10-Bit, Multichannel ADCs/DACs with FIFO, Temperature Sensing, and GPIO Ports

## General Description

The MAX1020/MAX1022/MAX1057/MAX1058 integrate a multichannel, 10-bit, analog-to-digital converter (ADC) and an octal, 10-bit, digital-to-analog converter (DAC) in a single IC. These devices also include a temperature sensor and configurable general-purpose I/O ports (GPIOs) with a 25MHz SPI-/QSPI™-/MICROWIRE®-compatible serial interface. The ADC is available in 8/12/16 input-channel versions. The octal DAC outputs settle within 2.0 $\mu$ s, and the ADC has a 225ksps conversion rate.

All devices include an internal reference (2.5V or 4.096V) providing a well-regulated, low-noise reference for both the ADC and DAC. Programmable reference modes for the ADC and the DAC allow the use of an internal reference, an external reference, or a combination of both. Features such as an internal  $\pm 1^{\circ}\text{C}$  accurate temperature sensor, FIFO, scan modes, programmable internal or external clock modes, data averaging, and AutoShutdown™ allow users to minimize both power consumption and processor requirements. The low glitch energy (4nV·s) and low digital feedthrough (0.5nV·s) of the integrated octal DACs make these devices ideal for digital control of fast-response closed-loop systems.

The devices are guaranteed to operate with a supply voltage from +2.7V to +3.6V (MAX1057) and from +4.75V to +5.25V (MAX1020/MAX1022/MAX1058). The devices consume 2.5mA at 225ksps throughput, only 22 $\mu$ A at 1ksps throughput, and under 0.2 $\mu$ A in the shutdown mode. The MAX1057/MAX1058 feature 12 GPIOs, while the MAX1020 offers four GPIOs that can be configured as inputs or outputs.

The MAX1057/MAX1058 are available in 48-pin thin QFN packages. The MAX1020/MAX1022 are available in 36-pin thin QFN packages. All devices are specified over the -40°C to +85°C temperature range.

## Applications

Controls for Optical Components  
Base-Station Control Loops  
System Supervision and Control  
Data-Acquisition Systems

## Features

- ◆ 10-Bit, 225ksps ADC
  - Analog Multiplexer with True-Differential Track/Hold (T/H)
  - 16 Single-Ended Channels or 8 Differential Channels (Unipolar or Bipolar) (MAX1057/MAX1058)
  - 12 Single-Ended Channels or 6 Differential Channels (Unipolar or Bipolar) (MAX1022)
  - 8 Single-Ended Channels or 4 Differential Channels (Unipolar or Bipolar) (MAX1020)
  - Excellent Accuracy:  $\pm 0.5$  LSB INL,  $\pm 0.5$  LSB DNL
- ◆ 10-Bit, Octal, 2 $\mu$ s Settling DAC
  - Ultra-Low Glitch Energy (4nV·s)
  - Power-Up Options from Zero Scale or Full Scale
  - Excellent Accuracy:  $\pm 1$  LSB INL
- ◆ Internal Reference or External Single-Ended/Differential Reference
  - Internal Reference Voltage 2.5V or 4.096V
- ◆ Internal  $\pm 1^{\circ}\text{C}$  Accurate Temperature Sensor
- ◆ On-Chip FIFO Capable of Storing 16 ADC Conversion Results and One Temperature Result
- ◆ On-Chip Channel-Scan Mode and Internal Data-Averaging Features
- ◆ Analog Single-Supply Operation
  - +2.7V to +3.6V or +4.75V to +5.25V
- ◆ Digital Supply: 2.7V to V<sub>AVDD</sub>
- ◆ 25MHz, SPI/QSPI/MICROWIRE Serial Interface
- ◆ AutoShutdown Between Conversions
- ◆ Low-Power ADC
  - 2.5mA at 225ksps
  - 22 $\mu$ A at 1ksps
  - 0.2 $\mu$ A at Shutdown
- ◆ Low-Power DAC: 1.5mA
- ◆ Evaluation Kit Available (Order MAX1258EVKIT)

QSPI is a trademark of Motorola, Inc.

MICROWIRE is a registered trademark of National Semiconductor Corp.

AutoShutdown is a trademark of Maxim Integrated Products, Inc.

## Ordering Information/Selector Guide

PART	TEMP RANGE	PIN-PACKAGE	REF VOLTAGE (V)	ANALOG SUPPLY VOLTAGE (V)	RESOLUTION BITS**	ADC CHANNELS	DAC CHANNELS	GPIOs
MAX1020BETX	-40°C to +85°C	36 TQFN-EP*	4.096	4.75 to 5.25	10	8	8	4
MAX1022BETX	-40°C to +85°C	36 TQFN-EP*	4.096	4.75 to 5.25	10	12	8	0
MAX1057BETM	-40°C to +85°C	48 TQFN-EP*	2.5	2.7 to 3.6	10	16	8	12
MAX1058BETM	-40°C to +85°C	48 TQFN-EP*	4.096	4.75 to 5.25	10	16	8	12

\*EP = Exposed pad.

\*\*Number of resolution bits refers to both DAC and ADC.

Pin Configurations appear at end of data sheet.



Maxim Integrated Products 1

For pricing, delivery, and ordering information, please contact Maxim Direct at 1-888-629-4642, or visit Maxim's website at [www.maxim-ic.com](http://www.maxim-ic.com).

MAX1020/MAX1022/MAX1057/MAX1058

# 10-Bit, Multichannel ADCs/DACs with FIFO, Temperature Sensing, and GPIO Ports

## ABSOLUTE MAXIMUM RATINGS

AVDD to AGND .....	-0.3V to +6V	Continuous Power Dissipation (multilayer board, T <sub>A</sub> = +70°C)
DGND to AGND.....	-0.3V to +0.3V	36-Pin TQFN (6mm x 6mm)
DVDD to AVDD .....	-3.0V to +0.3V	(derate 35.7mW/°C above +70°C).....
Digital Inputs to DGND.....	-0.3V to +6V	2857.1mW
Digital Outputs to DGND .....	-0.3V to (V <sub>DVDD</sub> + 0.3V)	48-Pin TQFN (7mm x 7mm)
Analog Inputs, Analog Outputs and REF_ <sub>-</sub>		(derate 40mW/°C above +70°C).....
to AGND .....	-0.3V to (V <sub>AVDD</sub> + 0.3V)	3200mW
Maximum Current into Any Pin (except AGND, DGND, AVDD,		Operating Temperature Range .....
DVDD, and OUT_ <sub>-</sub> ).....	50mA	-40°C to +85°C
Maximum Current into OUT_ <sub>-</sub> .....	100mA	Storage Temperature Range .....
		-60°C to +150°C
		Junction Temperature .....
		+150°C
		Lead Temperature (soldering, 10s).....
		+300°C

**Note:** If the package power dissipation is not exceeded, one output at a time may be shorted to AVDD, DVDD, AGND, or DGND indefinitely

Stresses beyond those listed under "Absolute Maximum Ratings" may cause permanent damage to the device. These are stress ratings only, and functional operation of the device at these or any other conditions beyond those indicated in the operational sections of the specifications is not implied. Exposure to absolute maximum rating conditions for extended periods may affect device reliability.

## ELECTRICAL CHARACTERISTICS

(V<sub>AVDD</sub> = V<sub>DVDD</sub> = 2.7V to 3.6V (MAX1057), external reference V<sub>REF</sub> = 2.5V (MAX1057), V<sub>AVDD</sub> = V<sub>DVDD</sub> = 4.75V to 5.25V (MAX1020/MAX1022/MAX1058), external reference V<sub>REF</sub> = 4.096V (MAX1020/MAX1022/MAX1058), f<sub>CLK</sub> = 3.6MHz (50% duty cycle), T<sub>A</sub> = -40°C to +85°C, unless otherwise noted. Typical values are at V<sub>AVDD</sub> = V<sub>DVDD</sub> = 3V (MAX1057), V<sub>AVDD</sub> = V<sub>DVDD</sub> = 5V (MAX1020/MAX1022/MAX1058), T<sub>A</sub> = +25°C. Outputs are unloaded, unless otherwise noted.)

PARAMETER	SYMBOL	CONDITIONS	MIN	TYP	MAX	UNITS
<b>ADC</b>						
<b>DC ACCURACY (Note 1)</b>						
Resolution			10			Bits
Integral Nonlinearity	INL			±0.5	±1.0	LSB
Differential Nonlinearity	DNL			±0.5	±1.0	LSB
Offset Error				±0.25	±2.0	LSB
Gain Error		(Note 2)		±0.025	±2.0	LSB
Gain Temperature Coefficient				±1.4		ppm/°C
Channel-to-Channel Offset				±0.1		LSB
<b>DYNAMIC SPECIFICATIONS (10kHz sine-wave input, V<sub>IN</sub> = 2.5V<sub>P-P</sub> (MAX1057), V<sub>IN</sub> = 4.096V<sub>P-P</sub> (MAX1020/MAX1022/MAX1058), 225ksps, f<sub>SCLK</sub> = 3.6MHz)</b>						
Signal-to-Noise Plus Distortion	SINAD			61		dB
Total Harmonic Distortion (Up to the Fifth Harmonic)	THD			-70		dBc
Spurious-Free Dynamic Range	SFDR			66		dBc
Intermodulation Distortion	IMD	f <sub>IN1</sub> = 9.9kHz, f <sub>IN2</sub> = 10.2kHz		72		dBc
Full-Linear Bandwidth		SINAD > 70dB		100		kHz
Full-Power Bandwidth		-3dB point		1		MHz
<b>CONVERSION RATE (Note 3)</b>						
Power-Up Time	t <sub>PU</sub>	External reference		0.8		μs
		Internal reference (Note 4)		218		Conversion Clock Cycles

# 10-Bit, Multichannel ADCs/DACs with FIFO, Temperature Sensing, and GPIO Ports

MAX1020/MAX1022/MAX1057/MAX1058

## ELECTRICAL CHARACTERISTICS (continued)

( $V_{AVDD} = V_{DVDD} = 2.7V$  to  $3.6V$  (MAX1057), external reference  $V_{REF} = 2.5V$  (MAX1057),  $V_{AVDD} = V_{DVDD} = 4.75V$  to  $5.25V$  (MAX1020/MAX1022/MAX1058), external reference  $V_{REF} = 4.096V$  (MAX1020/MAX1022/MAX1058),  $f_{CLK} = 3.6MHz$  (50% duty cycle),  $T_A = -40^{\circ}C$  to  $+85^{\circ}C$ , unless otherwise noted. Typical values are at  $V_{AVDD} = V_{DVDD} = 3V$  (MAX1057),  $V_{AVDD} = V_{DVDD} = 5V$  (MAX1020/MAX1022/MAX1058),  $T_A = +25^{\circ}C$ . Outputs are unloaded, unless otherwise noted.)

PARAMETER	SYMBOL	CONDITIONS	MIN	TYP	MAX	UNITS
Acquisition Time	$t_{ACQ}$	(Note 5)	0.6			$\mu s$
Conversion Time	$t_{CONV}$	Internally clocked		5.5		$\mu s$
		Externally clocked	3.6			
External Clock Frequency	$f_{CLK}$	Externally clocked conversion (Note 5)	0.1		3.6	MHz
Duty Cycle			40		60	%
Aperture Delay				30		ns
Aperture Jitter				< 50		ps
<b>ANALOG INPUTS</b>						
Input Voltage Range (Note 6)		Unipolar	0		$V_{REF}$	V
		Bipolar	$-V_{REF} / 2$		$V_{REF} / 2$	
Input Leakage Current				$\pm 0.01$	$\pm 1$	$\mu A$
Input Capacitance				24		pF
<b>INTERNAL TEMPERATURE SENSOR</b>						
Measurement Error (Notes 5, 7)		$T_A = +25^{\circ}C$		$\pm 0.7$		$^{\circ}C$
		$T_A = T_{MIN}$ to $T_{MAX}$		$\pm 1.0$	$\pm 3.0$	
Temperature Resolution				1/8		$^{\circ}C/LSB$
<b>INTERNAL REFERENCE</b>						
REF1 Output Voltage (Note 8)		MAX1057	2.482	2.50	2.518	V
		MAX1020/MAX1022/MAX1058	4.066	4.096	4.126	
REF1 Voltage Temperature Coefficient	$TC_{REF}$			$\pm 30$		ppm/ $^{\circ}C$
REF1 Output Impedance				6.5		k $\Omega$
REF1 Short-Circuit Current		$V_{REF} = 2.5V$		0.39		mA
		$V_{REF} = 4.096V$		0.63		
<b>EXTERNAL REFERENCE</b>						
REF1 Input Voltage Range	$V_{REF1}$	REF mode 11 (Note 4)	1		$V_{AVDD} + 0.05$	V
REF2 Input Voltage Range (Note 4)	$V_{REF2}$	REF mode 01	1		$V_{AVDD} + 0.05$	V
		REF mode 11	0		1	

# 10-Bit, Multichannel ADCs/DACs with FIFO, Temperature Sensing, and GPIO Ports

## ELECTRICAL CHARACTERISTICS (continued)

( $V_{AVDD} = V_{DVDD} = 2.7V$  to  $3.6V$  (MAX1057), external reference  $V_{REF} = 2.5V$  (MAX1057),  $V_{AVDD} = V_{DVDD} = 4.75V$  to  $5.25V$  (MAX1020/MAX1022/MAX1058), external reference  $V_{REF} = 4.096V$  (MAX1020/MAX1022/MAX1058),  $f_{CLK} = 3.6MHz$  (50% duty cycle),  $T_A = -40^{\circ}C$  to  $+85^{\circ}C$ , unless otherwise noted. Typical values are at  $V_{AVDD} = V_{DVDD} = 3V$  (MAX1057),  $V_{AVDD} = V_{DVDD} = 5V$  (MAX1020/MAX1022/MAX1058),  $T_A = +25^{\circ}C$ . Outputs are unloaded, unless otherwise noted.)

PARAMETER	SYMBOL	CONDITIONS	MIN	TYP	MAX	UNITS
REF1 Input Current (Note 9)	$I_{REF1}$	$V_{REF} = 2.5V$ (MAX1057), $f_{SAMPLE} = 225ksps$		25	80	$\mu A$
		$V_{REF} = 4.096V$ (MAX1020/MAX1022/MAX1058), $f_{SAMPLE} = 225ksps$		40	80	
		Acquisition between conversions		$\pm 0.01$	$\pm 1$	
REF2 Input Current	$I_{REF2}$	$V_{REF} = 2.5V$ (MAX1057), $f_{SAMPLE} = 225ksps$		25	80	$\mu A$
		$V_{REF} = 4.096V$ (MAX1020/MAX1022/MAX1058), $f_{SAMPLE} = 225ksps$		40	80	
		Acquisition between conversions		$\pm 0.01$	$\pm 1$	
<b>DAC</b>						
<b>DC ACCURACY (Note 10)</b>						
Resolution			10			Bits
Integral Nonlinearity	INL			$\pm 0.5$	$\pm 1$	LSB
Differential Nonlinearity	DNL	Guaranteed monotonic			$\pm 0.5$	LSB
Offset Error	$V_{OS}$	(Note 8)		$\pm 3$	$\pm 10$	mV
Offset-Error Drift				$\pm 10$		ppm of FS/ $^{\circ}C$
Gain Error	GE	(Note 8)		$\pm 1.25$	$\pm 10$	LSB
Gain Temperature Coefficient				$\pm 8$		ppm of FS/ $^{\circ}C$
<b>DAC OUTPUT</b>						
Output-Voltage Range		No load	0.02		$V_{AVDD} - 0.02$	V
		10k $\Omega$ load to either rail	0.1		$V_{AVDD} - 0.1$	
DC Output Impedance				0.5		$\Omega$
Capacitive Load		(Note 11)			1	nF
Resistive Load to AGND	$R_L$	$V_{AVDD} = 2.7V$ , $V_{REF} = 2.5V$ (MAX1057), gain error < 1%	2000			$\Omega$
		$V_{AVDD} = 4.75V$ , $V_{REF} = 4.096V$ (MAX1020/MAX1022/MAX1058), gain error < 2%	500			

# 10-Bit, Multichannel ADCs/DACs with FIFO, Temperature Sensing, and GPIO Ports

MAX1020/MAX1022/MAX1057/MAX1058

## ELECTRICAL CHARACTERISTICS (continued)

( $V_{AVDD} = V_{DVDD} = 2.7V$  to  $3.6V$  (MAX1057), external reference  $V_{REF} = 2.5V$  (MAX1057),  $V_{AVDD} = V_{DVDD} = 4.75V$  to  $5.25V$  (MAX1020/MAX1022/MAX1058), external reference  $V_{REF} = 4.096V$  (MAX1020/MAX1022/MAX1058),  $f_{CLK} = 3.6MHz$  (50% duty cycle),  $T_A = -40^{\circ}C$  to  $+85^{\circ}C$ , unless otherwise noted. Typical values are at  $V_{AVDD} = V_{DVDD} = 3V$  (MAX1057),  $V_{AVDD} = V_{DVDD} = 5V$  (MAX1020/MAX1022/MAX1058),  $T_A = +25^{\circ}C$ . Outputs are unloaded, unless otherwise noted.)

PARAMETER	SYMBOL	CONDITIONS	MIN	TYP	MAX	UNITS
Wake-Up Time (Note 12)		From power-down mode, $V_{AVDD} = 5V$		25		$\mu s$
		From power-down mode, $V_{AVDD} = 2.7V$		21		
1k $\Omega$ Output Termination		Programmed in power-down mode		1		k $\Omega$
100k $\Omega$ Output Termination		At wake-up or programmed in power-down mode		100		k $\Omega$
<b>DYNAMIC PERFORMANCE (Notes 5, 13)</b>						
Output-Voltage Slew Rate	SR	Positive and negative	3			V/ $\mu s$
Output-Voltage Settling Time	$t_S$	To 1 LSB, 400 - C00 hex (Note 7)		2	5	$\mu s$
Digital Feedthrough		Code 0, all digital inputs from 0 to $V_{DVDD}$		0.5		nV $\cdot s$
Major Code Transition Glitch Impulse		Between codes 2047 and 2048		4		nV $\cdot s$
Output Noise (0.1Hz to 50MHz)		From $V_{REF}$		660		$\mu V_{P-P}$
		Using internal reference		720		
Output Noise (0.1Hz to 500kHz)		From $V_{REF}$		260		$\mu V_{P-P}$
		Using internal reference		320		
DAC-to-DAC Transition Crosstalk				0.5		nV $\cdot s$
<b>INTERNAL REFERENCE</b>						
REF1 Output Voltage (Note 8)		MAX1057	2.482	2.50	2.518	V
		MAX1020/MAX1022/MAX1058	4.066	4.096	4.126	
REF1 Temperature Coefficient	$TC_{REF}$			$\pm 30$		ppm/ $^{\circ}C$
REF1 Short-Circuit Current		$V_{REF} = 2.5V$		0.39		mA
		$V_{REF} = 4.096V$		0.63		
<b>EXTERNAL-REFERENCE INPUT</b>						
REF1 Input Voltage Range	$V_{REF1}$	REF modes 01, 10, and 11 (Note 4)	0.7		$V_{AVDD}$	V
REF1 Input Impedance	$R_{REF1}$		70	100	130	k $\Omega$
<b>DIGITAL INTERFACE</b>						
<b>DIGITAL INPUTS (SCLK, DIN, <math>\overline{CS}</math>, <math>\overline{CNVST}</math>, LDAC)</b>						
Input-Voltage High	$V_{IH}$	$V_{DVDD} = 2.7V$ to $5.25V$	2.4			V
Input-Voltage Low	$V_{IL}$	$V_{DVDD} = 3.6V$ to $5.25V$			0.8	V
		$V_{DVDD} = 2.7V$ to $3.6V$			0.6	
Input Leakage Current	$I_L$			$\pm 0.01$	$\pm 10$	$\mu A$
Input Capacitance	$C_{IN}$			15		pF
<b>DIGITAL OUTPUT (DOUT) (Note 14)</b>						
Output-Voltage Low	$V_{OL}$	$I_{SINK} = 2mA$			0.4	V

# 10-Bit, Multichannel ADCs/DACs with FIFO, Temperature Sensing, and GPIO Ports

## ELECTRICAL CHARACTERISTICS (continued)

( $V_{AVDD} = V_{DVDD} = 2.7V$  to  $3.6V$  (MAX1057), external reference  $V_{REF} = 2.5V$  (MAX1057),  $V_{AVDD} = V_{DVDD} = 4.75V$  to  $5.25V$  (MAX1020/MAX1022/MAX1058), external reference  $V_{REF} = 4.096V$  (MAX1020/MAX1022/MAX1058),  $f_{CLK} = 3.6MHz$  (50% duty cycle),  $T_A = -40^\circ C$  to  $+85^\circ C$ , unless otherwise noted. Typical values are at  $V_{AVDD} = V_{DVDD} = 3V$  (MAX1057),  $V_{AVDD} = V_{DVDD} = 5V$  (MAX1020/MAX1022/MAX1058),  $T_A = +25^\circ C$ . Outputs are unloaded, unless otherwise noted.)

PARAMETER	SYMBOL	CONDITIONS	MIN	TYP	MAX	UNITS	
Output-Voltage High	$V_{OH}$	$I_{SOURCE} = 2mA$	$V_{DVDD} - 0.5$			V	
Tri-State Leakage Current					$\pm 10$	$\mu A$	
Tri-State Output Capacitance	$C_{OUT}$			15		pF	
<b>DIGITAL OUTPUT (EOC) (Note 14)</b>							
Output-Voltage Low	$V_{OL}$	$I_{SINK} = 2mA$			0.4	V	
Output-Voltage High	$V_{OH}$	$I_{SOURCE} = 2mA$	$V_{DVDD} - 0.5$			V	
Tri-State Leakage Current					$\pm 10$	$\mu A$	
Tri-State Output Capacitance	$C_{OUT}$			15		pF	
<b>DIGITAL OUTPUTS (GPIO_) (Note 14)</b>							
GPIOB_, GPIOC_ Output-Voltage Low		$I_{SINK} = 2mA$			0.4	V	
		$I_{SINK} = 4mA$			0.8		
GPIOB_, GPIOC_ Output-Voltage High		$I_{SOURCE} = 2mA$	$V_{DVDD} - 0.5$			V	
GPIOA_ Output-Voltage Low		$I_{SINK} = 15mA$			0.8	V	
GPIOA_ Output-Voltage High		$I_{SOURCE} = 15mA$	$V_{DVDD} - 0.8$			V	
Tri-State Leakage Current					$\pm 10$	$\mu A$	
Tri-State Output Capacitance	$C_{OUT}$			15		pF	
<b>POWER REQUIREMENTS (Note 15)</b>							
Digital Positive-Supply Voltage	$V_{DVDD}$		2.70		$V_{AVDD}$	V	
Digital Positive-Supply Current	$D_{IDD}$	Idle, all blocks shut down		0.2	4	$\mu A$	
		Only ADC on, external reference		1		mA	
Analog Positive-Supply Voltage	$V_{AVDD}$	MAX1057	2.7		3.6	V	
		MAX1020/MAX1022/MAX1058	4.75		5.25		
Analog Positive Supply Current	$A_{IDD}$	Idle, all blocks shut down		0.2	2	$\mu A$	
		Only ADC on, external reference	$f_{SAMPLE} = 225ksps$		2.8	4.2	mA
			$f_{SAMPLE} = 100ksps$		2.6		
		All DACs on, no load, internal reference		1.5	4.0		
REF1 Positive-Supply Rejection	PSRR	$V_{AVDD} = 2.7V$ , MAX1057		-77		dB	
		$V_{AVDD} = 4.75V$ MAX1020/MAX1022/MAX1058		-80			
DAC Positive-Supply Rejection	PSRD	Output code = FFFhex	MAX1057, $V_{AVDD} = 2.7V$ to $3.6V$	$\pm 0.1$	$\pm 0.5$	mV	
			MAX1020/MAX1022/MAX1058, $V_{AVDD} = 4.75V$ to $5.25V$	$\pm 0.1$	$\pm 0.5$		

# 10-Bit, Multichannel ADCs/DACs with FIFO, Temperature Sensing, and GPIO Ports

MAX1020/MAX1022/MAX1057/MAX1058

## ELECTRICAL CHARACTERISTICS (continued)

( $V_{AVDD} = V_{DVDD} = 2.7V$  to  $3.6V$  (MAX1057), external reference  $V_{REF} = 2.5V$  (MAX1057),  $V_{AVDD} = V_{DVDD} = 4.75V$  to  $5.25V$  (MAX1020/MAX1022/MAX1058), external reference  $V_{REF} = 4.096V$  (MAX1020/MAX1022/MAX1058),  $f_{CLK} = 3.6MHz$  (50% duty cycle),  $T_A = -40^{\circ}C$  to  $+85^{\circ}C$ , unless otherwise noted. Typical values are at  $V_{AVDD} = V_{DVDD} = 3V$  (MAX1057),  $V_{AVDD} = V_{DVDD} = 5V$  (MAX1020/MAX1022/MAX1058),  $T_A = +25^{\circ}C$ . Outputs are unloaded, unless otherwise noted.)

PARAMETER	SYMBOL	CONDITIONS	MIN	TYP	MAX	UNITS
ADC Positive-Supply Rejection	PSRA	Full-scale input		$\pm 0.06$	$\pm 0.5$	mV
		MAX1057, $V_{AVDD} = 2.7V$ to MAX1020/MAX1022/MAX1058, $V_{AVDD} = 4.75V$ to $5.25V$		$\pm 0.06$	$\pm 0.5$	
<b>TIMING CHARACTERISTICS (Figures 6–13)</b>						
SCLK Clock Period	$t_{CP}$		40			ns
SCLK Pulse-Width High	$t_{CH}$	40/60 duty cycle	16			ns
SCLK Pulse-Width Low	$t_{CL}$	60/40 duty cycle	16			ns
GPIO Output Rise/Fall After $\overline{CS}$ Rise	$t_{GOD}$	$C_{LOAD} = 20pF$			100	ns
GPIO Input Setup Before $\overline{CS}$ Fall	$t_{GSU}$		0			ns
$\overline{LDAC}$ Pulse Width	$t_{LDACPWL}$		20			ns
SCLK Fall to DOUT Transition (Note 16)	$t_{DOT}$	$C_{LOAD} = 20pF$ , SLOW = 0	1.8		12.0	ns
		$C_{LOAD} = 20pF$ , SLOW = 1	10		40	
SCLK Rise to DOUT Transition (Notes 16, 17)	$t_{DOT}$	$C_{LOAD} = 20pF$ , SLOW = 0	1.8		12.0	ns
		$C_{LOAD} = 20pF$ , SLOW = 1	10		40	
$\overline{CS}$ Fall to SCLK Fall Setup Time	$t_{CSS}$		10			ns
SCLK Fall to $\overline{CS}$ Rise Setup Time	$t_{CSH}$		0			ns
DIN to SCLK Fall Setup Time	$t_{DS}$		10			ns
DIN to SCLK Fall Hold Time	$t_{DH}$		0		2000	ns
$\overline{CS}$ Pulse-Width High	$t_{CSPWH}$		50			ns
$\overline{CS}$ Rise to DOUT Disable	$t_{DOD}$	$C_{LOAD} = 20pF$			25	ns
$\overline{CS}$ Fall to DOUT Enable	$t_{DOE}$	$C_{LOAD} = 20pF$	1.5		25.0	ns
$\overline{EOC}$ Fall to $\overline{CS}$ Fall	$t_{RDS}$		30			ns
$\overline{CS}$ or $\overline{CNVST}$ Rise to $\overline{EOC}$ Fall—Internally Clocked Conversion Time	$t_{DOV}$	CKSEL = 01 (temp sense) or CKSEL = 10 (temp sense), internal reference on			65	$\mu s$
		CKSEL = 01 (temp sense) or CKSEL = 10 (temp sense), internal reference initially off			140	
		CKSEL = 01 (voltage conversion)			9	
		CKSEL = 10 (voltage conversion), internal reference on			9	
		CKSEL = 10 (voltage conversion), internal reference initially off			80	
$\overline{CNVST}$ Pulse Width	$t_{CSW}$	CKSEL = 00, CKSEL = 01 (temp sense)	40			ns
		CKSEL = 01 (voltage conversion)	1.4			$\mu s$

# 10-Bit, Multichannel ADCs/DACs with FIFO, Temperature Sensing, and GPIO Ports

## ELECTRICAL CHARACTERISTICS (continued)

( $V_{AVDD} = V_{DVDD} = 2.7V$  to  $3.6V$  (MAX1057), external reference  $V_{REF} = 2.5V$  (MAX1057),  $V_{AVDD} = V_{DVDD} = 4.75V$  to  $5.25V$  (MAX1020/MAX1022/MAX1058), external reference  $V_{REF} = 4.096V$  (MAX1020/MAX1022/MAX1058),  $f_{CLK} = 3.6MHz$  (50% duty cycle),  $T_A = -40^{\circ}C$  to  $+85^{\circ}C$ , unless otherwise noted. Typical values are at  $V_{AVDD} = V_{DVDD} = 3V$  (MAX1057),  $V_{AVDD} = V_{DVDD} = 5V$  (MAX1020/MAX1022/MAX1058),  $T_A = +25^{\circ}C$ . Outputs are unloaded, unless otherwise noted.)

- Note 1:** Tested at  $V_{DVDD} = V_{AVDD} = +3.6V$  (MAX1057),  $V_{DVDD} = V_{AVDD} = +5.25V$  (MAX1020/MAX1022/MAX1058).
- Note 2:** Offset nulled.
- Note 3:** No bus activity during conversion. Conversion time is defined as the number of conversion clock cycles multiplied by the clock period.
- Note 4:** See Table 5 for reference-mode details.
- Note 5:** Not production tested. Guaranteed by design.
- Note 6:** See the *ADC/DAC References* section.
- Note 7:** Fast automated test, excludes self-heating effects.
- Note 8:** Specified over the  $-40^{\circ}C$  to  $+85^{\circ}C$  temperature range.
- Note 9:**  $REFSEL[1:0] = 00$  and when DACs are not powered up.
- Note 10:** DAC linearity, gain, and offset measurements are made between codes 115 and 3981.
- Note 11:** The DAC buffers are guaranteed by design to be stable with a  $500pF$  load.
- Note 12:** Time required by the DAC output to power up and settle within 1 LSB in the external reference mode.
- Note 13:** All DAC dynamic specifications are valid for a load of  $1nF$  and  $10k\Omega$ .
- Note 14:** Only one digital output (either DOUT,  $\overline{EOC}$ , or the GPIOs) can be indefinitely shorted to either supply at one time.
- Note 15:** All digital inputs at either  $V_{DVDD}$  or DGND.  $V_{DVDD}$  should not exceed  $V_{AVDD}$ .
- Note 16:** See the *Reset Register* section and Table 9 for details on programming the SLOW bit.
- Note 17:** Clock mode 11 only.



# 10-Bit, Multichannel ADCs/DACs with FIFO, Temperature Sensing, and GPIO Ports

## Typical Operating Characteristics

( $V_{AVDD} = V_{DVDD} = 3V$  (MAX1057), external  $V_{REF} = 2.5V$  (MAX1057),  $V_{AVDD} = V_{DVDD} = 5V$  (MAX1020/MAX1022/MAX1058), external  $V_{REF} = 4.096V$  (MAX1020/MAX1022/MAX1058),  $f_{CLK} = 3.6MHz$  (50% duty cycle),  $f_{SAMPLE} = 225kpsps$ ,  $C_{LOAD} = 50pF$ ,  $0.1\mu F$  capacitor at REF,  $T_A = +25^\circ C$ , unless otherwise noted.)

MAX1020/MAX1022/MAX1057/MAX1058

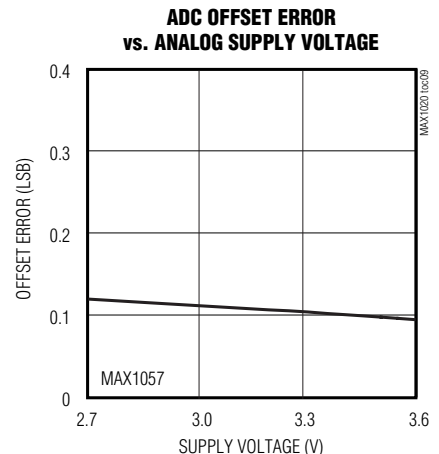
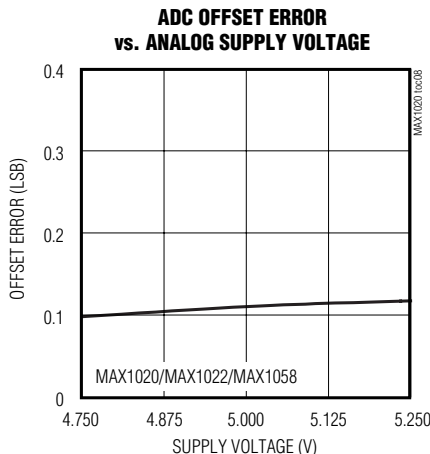
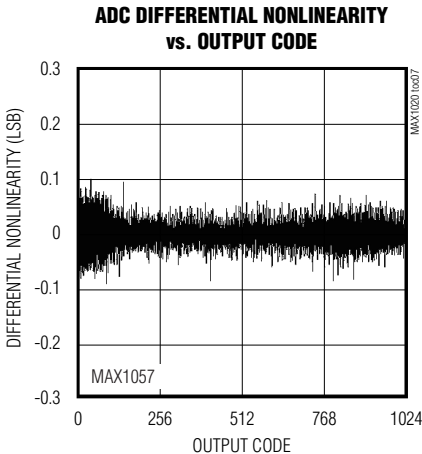
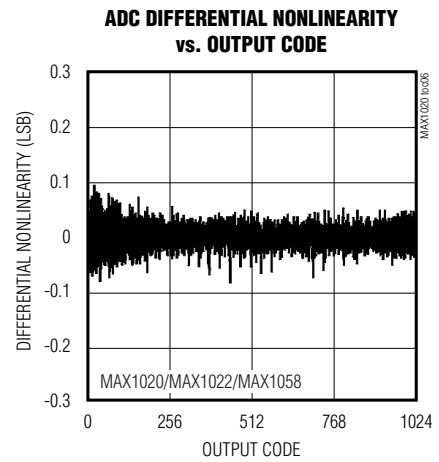
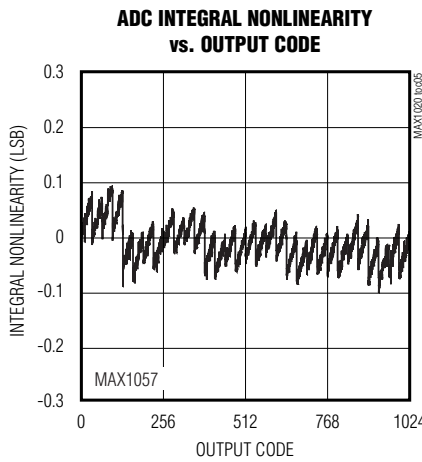
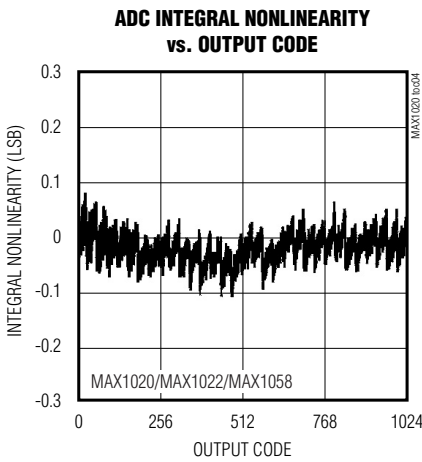
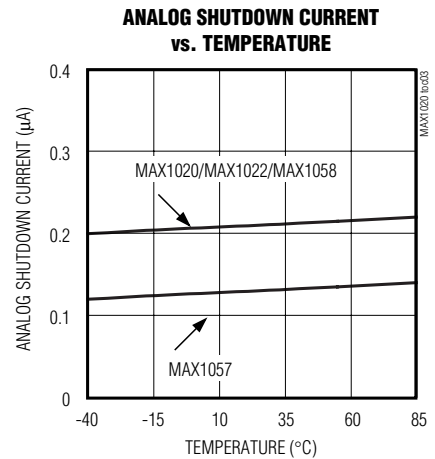
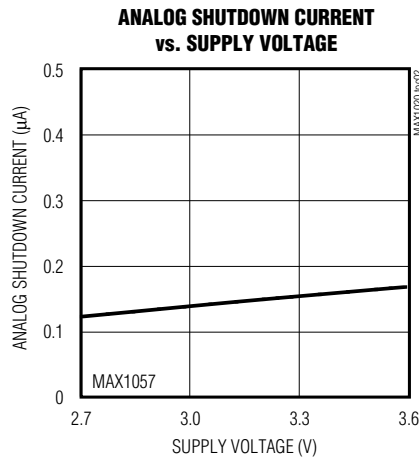
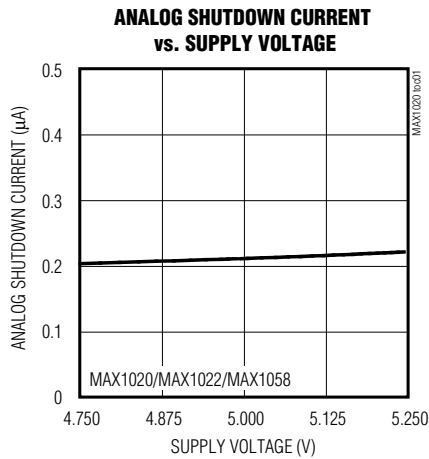

# 10-Bit, Multichannel ADCs/DACs with FIFO, Temperature Sensing, and GPIO Ports

## Typical Operating Characteristics (continued)

( $V_{AVDD} = V_{DVDD} = 3V$  (MAX1057), external  $V_{REF} = 2.5V$  (MAX1057),  $V_{AVDD} = V_{DVDD} = 5V$  (MAX1020/MAX1022/MAX1058), external  $V_{REF} = 4.096V$  (MAX1020/MAX1022/MAX1058),  $f_{CLK} = 3.6MHz$  (50% duty cycle),  $f_{SAMPLE} = 225ksps$ ,  $C_{LOAD} = 50pF$ ,  $0.1\mu F$  capacitor at REF,  $T_A = +25^\circ C$ , unless otherwise noted.)

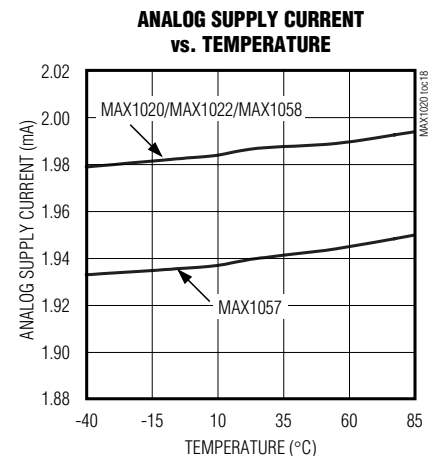
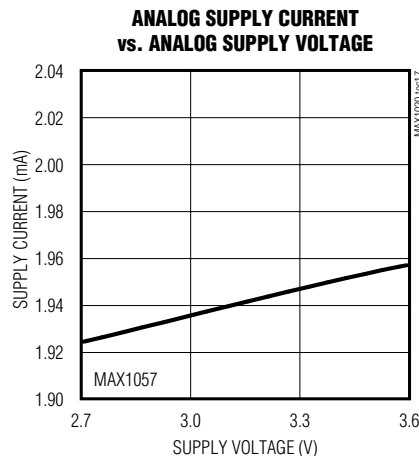
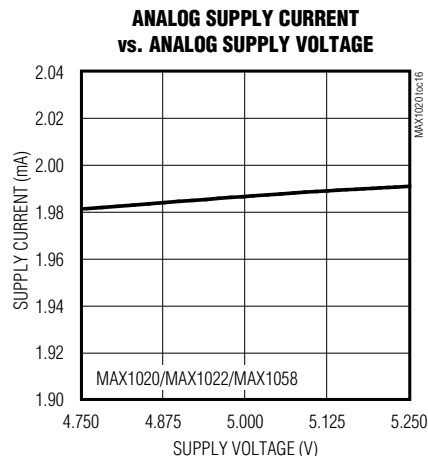
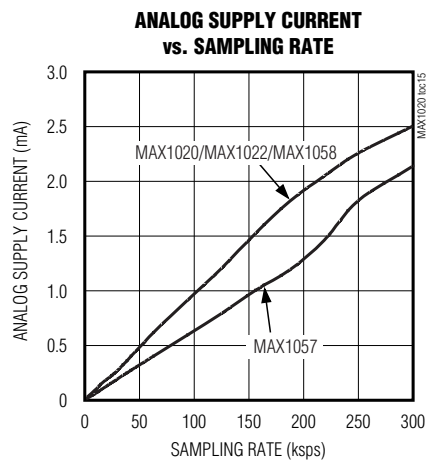
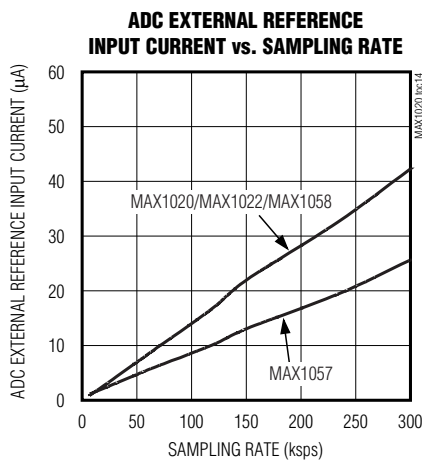
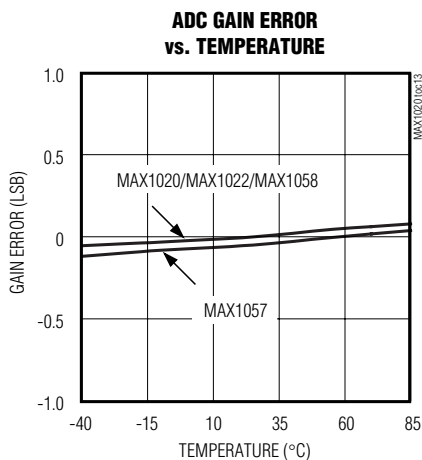
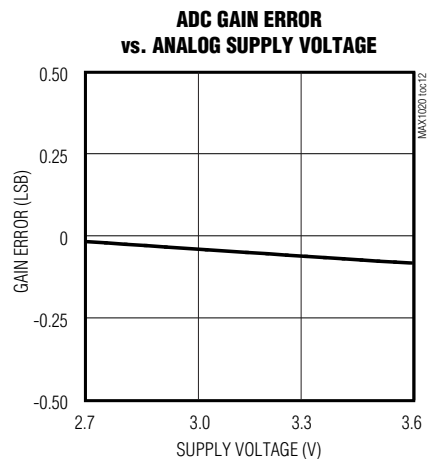
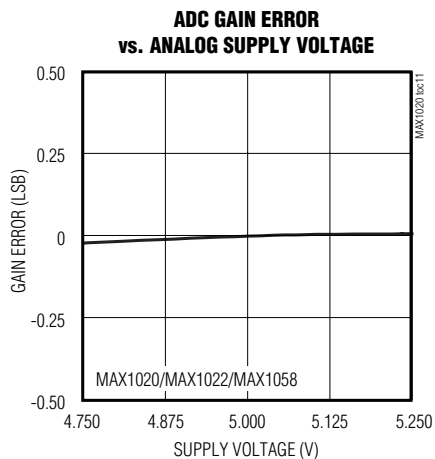
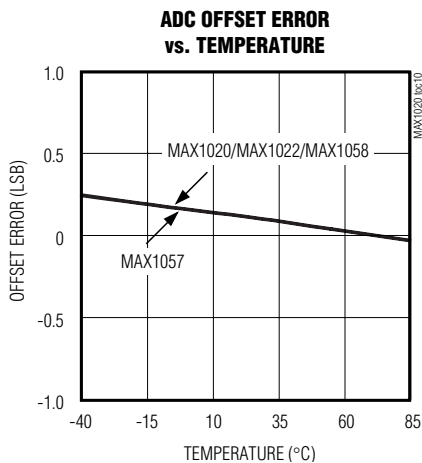

# 10-Bit, Multichannel ADCs/DACs with FIFO, Temperature Sensing, and GPIO Ports

## Typical Operating Characteristics (continued)

( $V_{AVDD} = V_{DVDD} = 3V$  (MAX1057), external  $V_{REF} = 2.5V$  (MAX1057),  $V_{AVDD} = V_{DVDD} = 5V$  (MAX1020/MAX1022/MAX1058), external  $V_{REF} = 4.096V$  (MAX1020/MAX1022/MAX1058),  $f_{CLK} = 3.6MHz$  (50% duty cycle),  $f_{SAMPLE} = 225kps$ ,  $C_{LOAD} = 50pF$ ,  $0.1\mu F$  capacitor at REF,  $T_A = +25^\circ C$ , unless otherwise noted.)

MAX1020/MAX1022/MAX1057/MAX1058

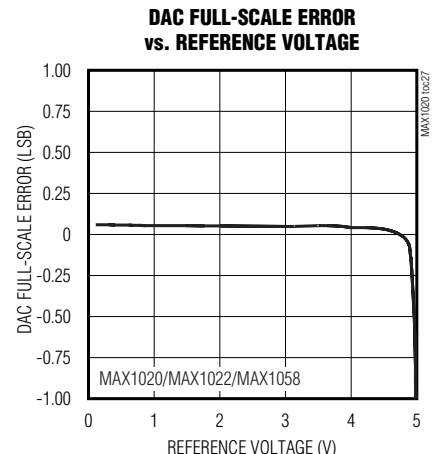
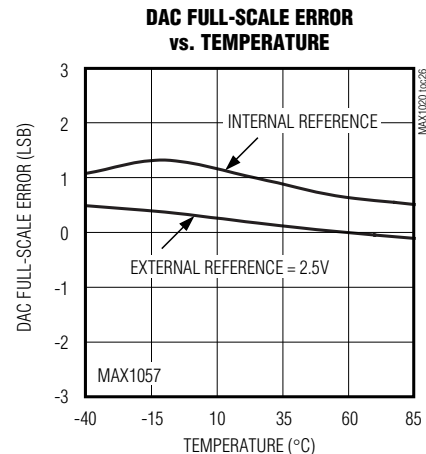
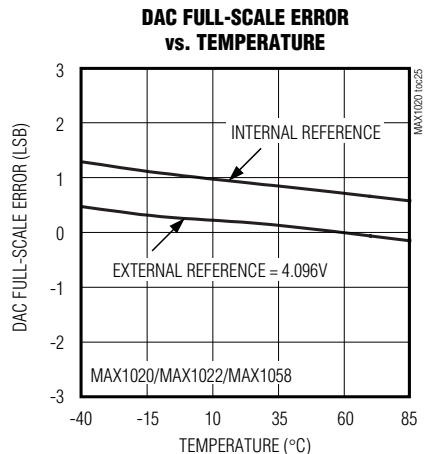
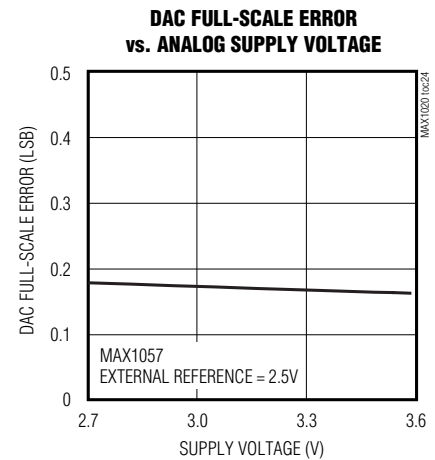
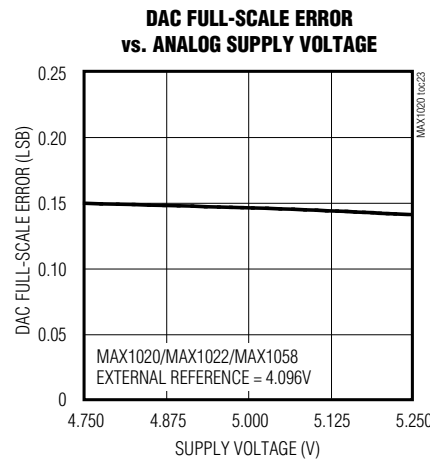
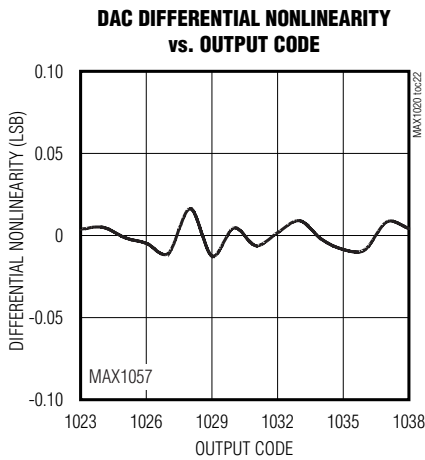
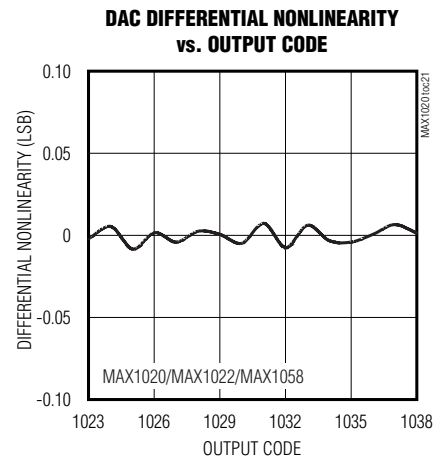
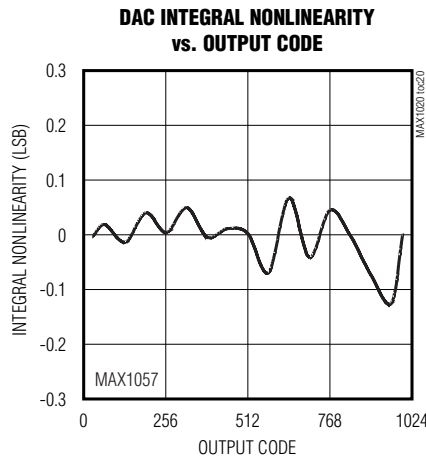
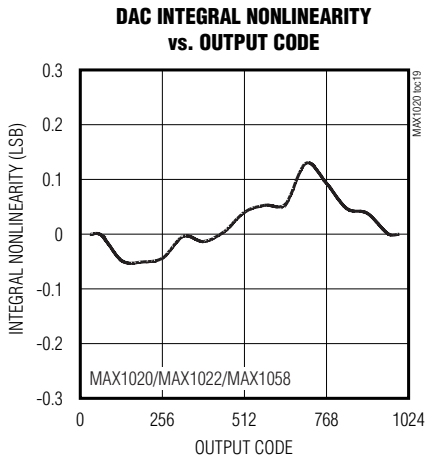

# 10-Bit, Multichannel ADCs/DACs with FIFO, Temperature Sensing, and GPIO Ports

## Typical Operating Characteristics (continued)

( $V_{AVDD} = V_{DVDD} = 3V$  (MAX1057), external  $V_{REF} = 2.5V$  (MAX1057),  $V_{AVDD} = V_{DVDD} = 5V$  (MAX1020/MAX1022/MAX1058), external  $V_{REF} = 4.096V$  (MAX1020/MAX1022/MAX1058),  $f_{CLK} = 3.6MHz$  (50% duty cycle),  $f_{SAMPLE} = 225ksp/s$ ,  $C_{LOAD} = 50pF$ ,  $0.1\mu F$  capacitor at REF,  $T_A = +25^\circ C$ , unless otherwise noted.)

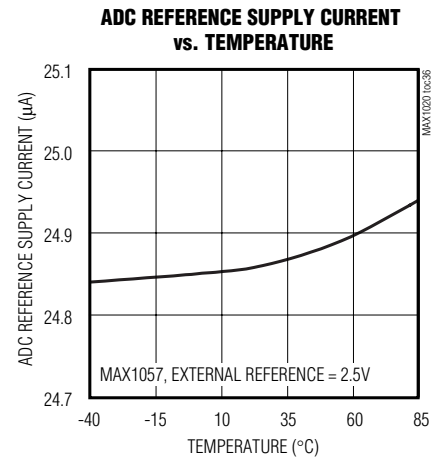
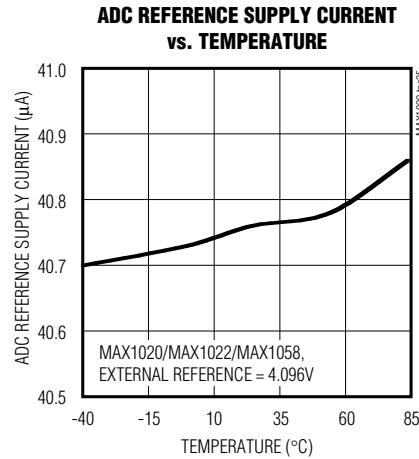
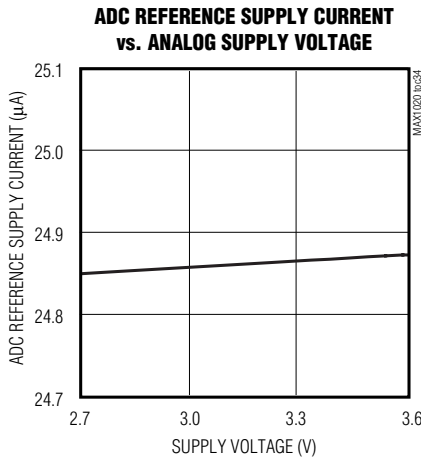
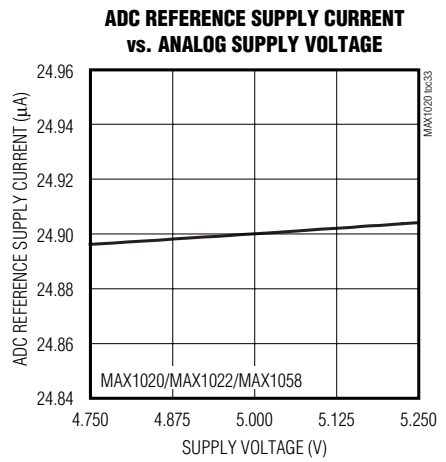
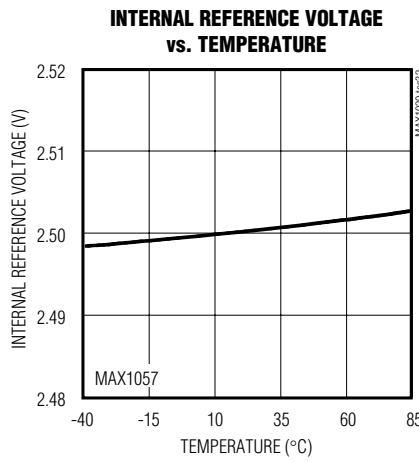
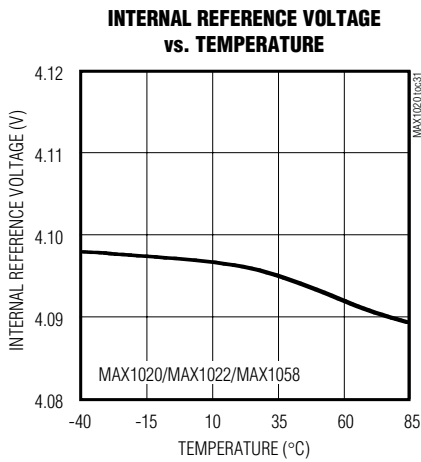
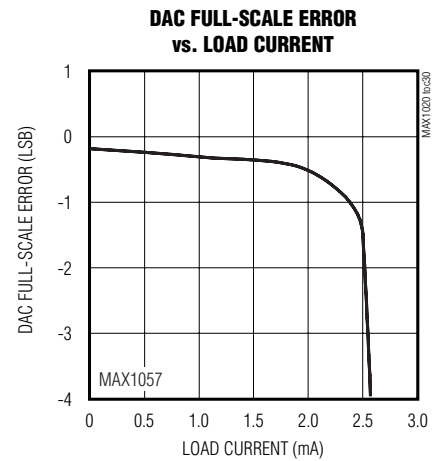
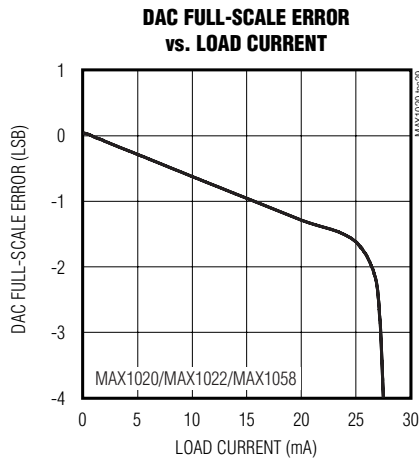
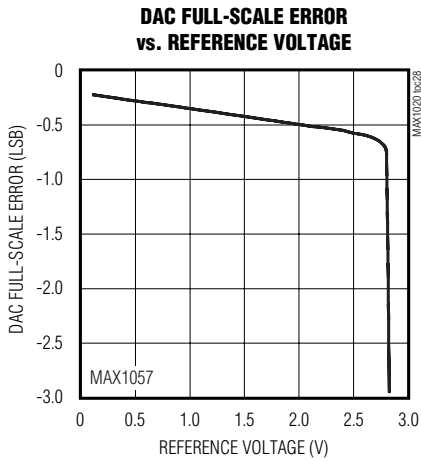

# 10-Bit, Multichannel ADCs/DACs with FIFO, Temperature Sensing, and GPIO Ports

## Typical Operating Characteristics (continued)

( $V_{AVDD} = V_{DVDD} = 3V$  (MAX1057), external  $V_{REF} = 2.5V$  (MAX1057),  $V_{AVDD} = V_{DVDD} = 5V$  (MAX1020/MAX1022/MAX1058), external  $V_{REF} = 4.096V$  (MAX1020/MAX1022/MAX1058),  $f_{CLK} = 3.6MHz$  (50% duty cycle),  $f_{SAMPLE} = 225kps$ ,  $C_{LOAD} = 50pF$ ,  $0.1\mu F$  capacitor at REF,  $T_A = +25^\circ C$ , unless otherwise noted.)

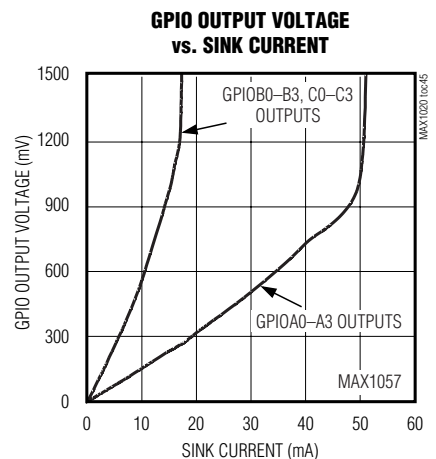
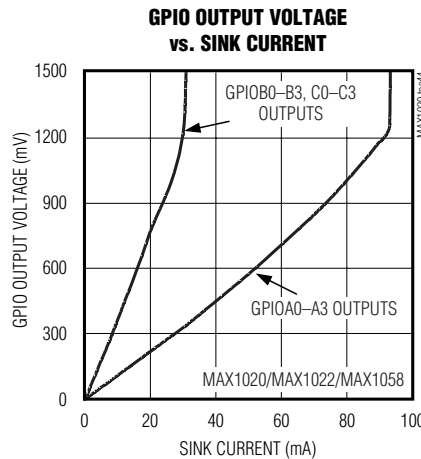
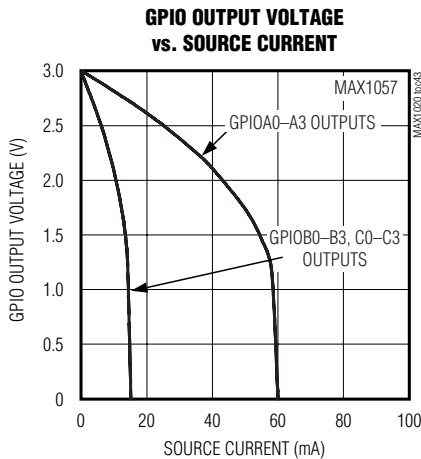
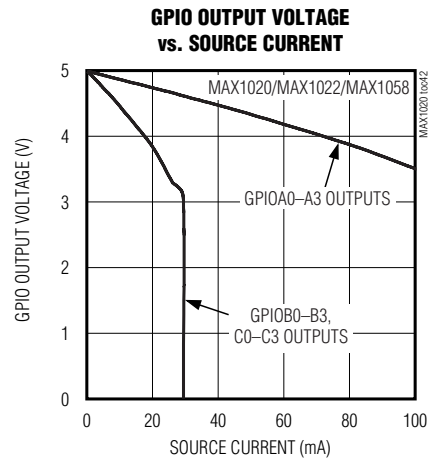
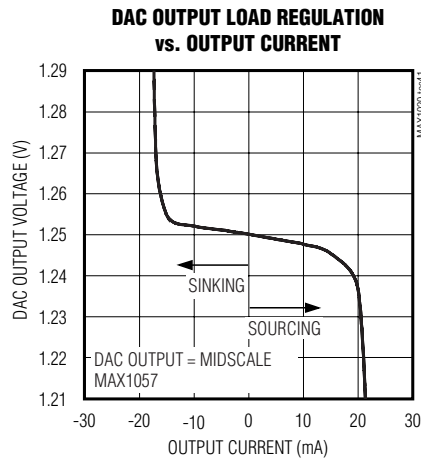
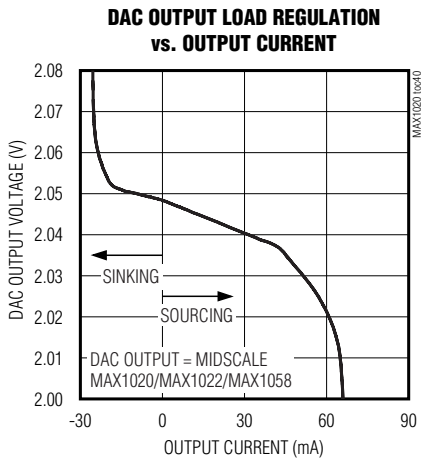
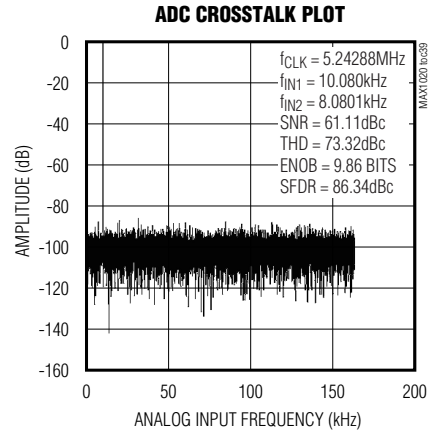
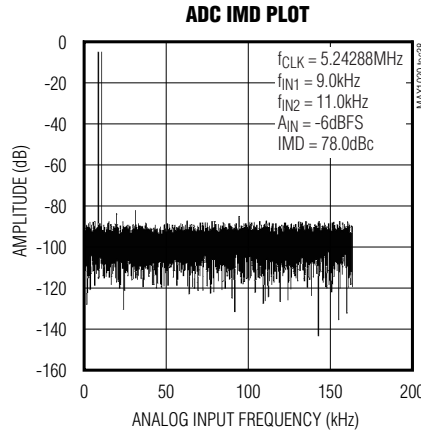
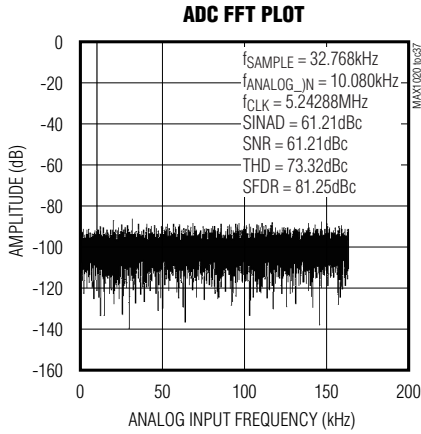

MAX1020/MAX1022/MAX1057/MAX1058

# 10-Bit, Multichannel ADCs/DACs with FIFO, Temperature Sensing, and GPIO Ports

## Typical Operating Characteristics (continued)

( $V_{AVDD} = V_{DVDD} = 3V$  (MAX1057), external  $V_{REF} = 2.5V$  (MAX1057),  $V_{AVDD} = V_{DVDD} = 5V$  (MAX1020/MAX1022/MAX1058), external  $V_{REF} = 4.096V$  (MAX1020/MAX1022/MAX1058),  $f_{CLK} = 3.6MHz$  (50% duty cycle),  $f_{SAMPLE} = 225ksps$ ,  $C_{LOAD} = 50pF$ ,  $0.1\mu F$  capacitor at REF,  $T_A = +25^\circ C$ , unless otherwise noted.)

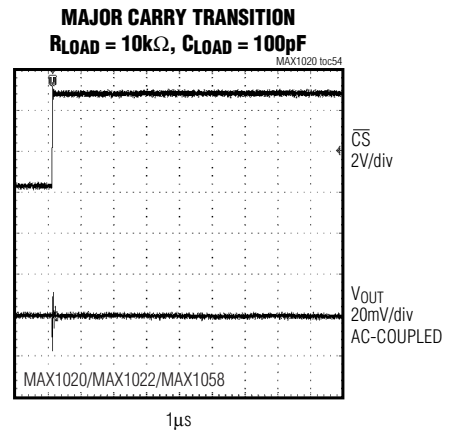
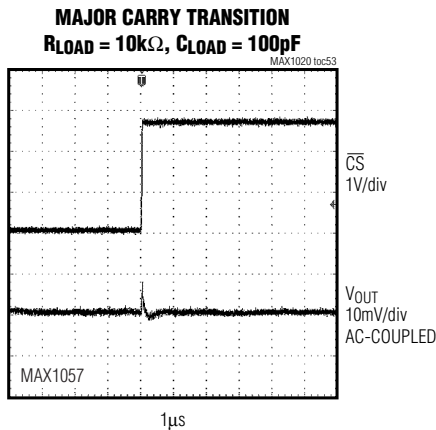
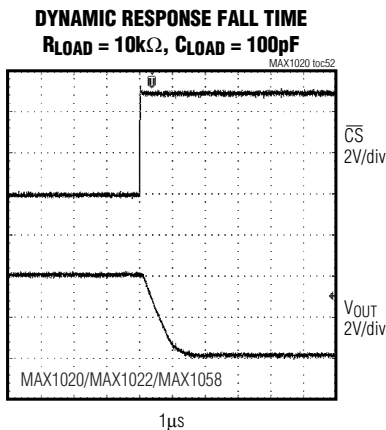
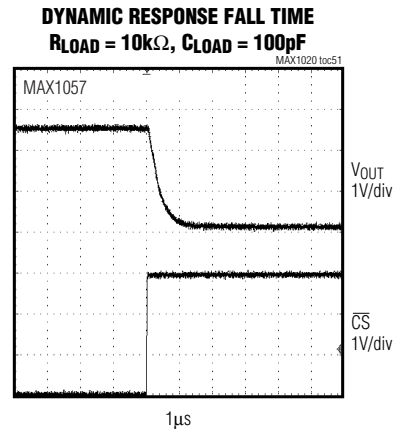
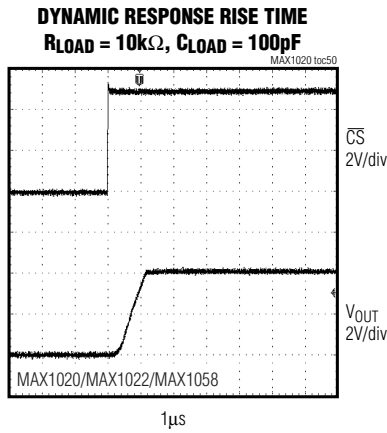
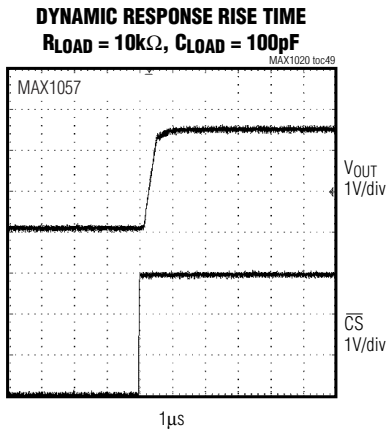
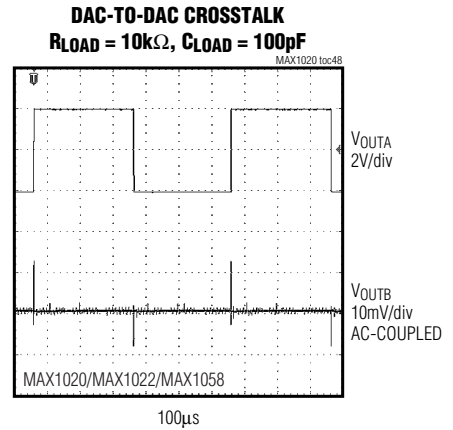
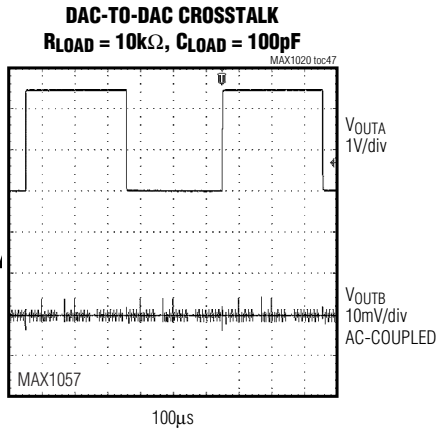
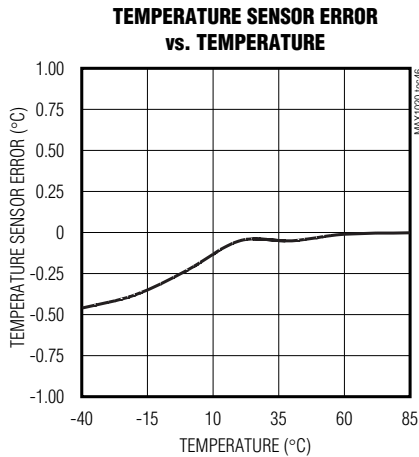

# 10-Bit, Multichannel ADCs/DACs with FIFO, Temperature Sensing, and GPIO Ports

## Typical Operating Characteristics (continued)

( $V_{AVDD} = V_{DVDD} = 3V$  (MAX1057), external  $V_{REF} = 2.5V$  (MAX1057),  $V_{AVDD} = V_{DVDD} = 5V$  (MAX1020/MAX1022/MAX1058), external  $V_{REF} = 4.096V$  (MAX1020/MAX1022/MAX1058),  $f_{CLK} = 3.6MHz$  (50% duty cycle),  $f_{SAMPLE} = 225ksps$ ,  $C_{LOAD} = 50pF$ ,  $0.1\mu F$  capacitor at REF,  $T_A = +25^\circ C$ , unless otherwise noted.)

**DAC DIGITAL FEEDTHROUGH ( $R_{LOAD} = 10k\Omega$ ,  $C_{LOAD} = 100pF$ ,  $\overline{CS} = HIGH$ ,  $DIN = LOW$ )**

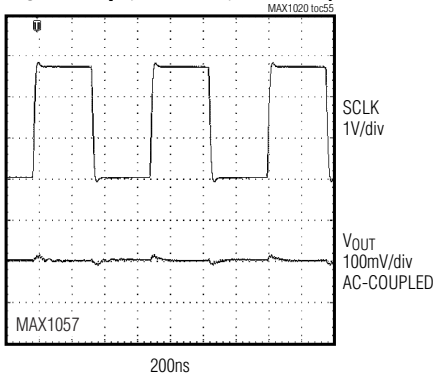

**DAC DIGITAL FEEDTHROUGH ( $R_{LOAD} = 10k\Omega$ ,  $C_{LOAD} = 100pF$ ,  $\overline{CS} = HIGH$ ,  $DIN = LOW$ )**

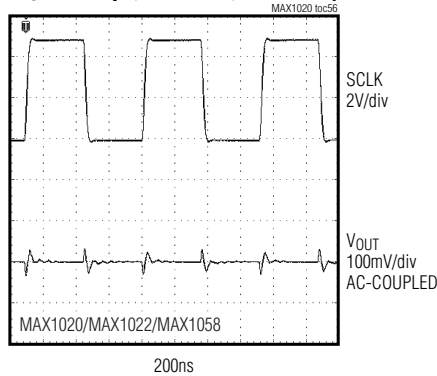

**NEGATIVE FULL-SCALE SETTLING TIME  $R_{LOAD} = 10k\Omega$ ,  $C_{LOAD} = 100pF$**

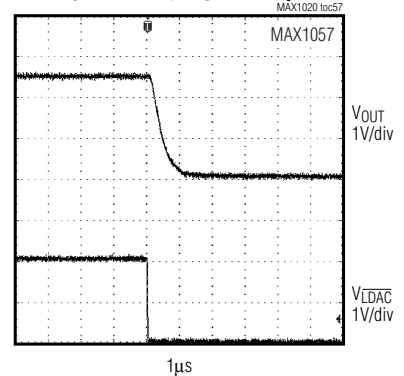

**NEGATIVE FULL-SCALE SETTLING TIME  $R_{LOAD} = 10k\Omega$ ,  $C_{LOAD} = 100pF$**

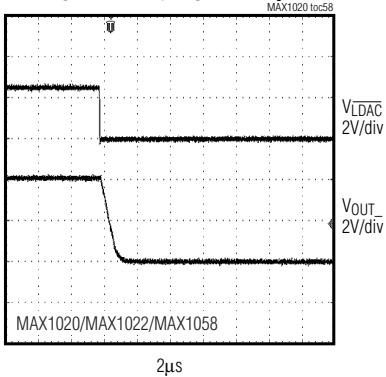

**POSITIVE FULL-SCALE SETTLING TIME  $R_{LOAD} = 10k\Omega$ ,  $C_{LOAD} = 100pF$**

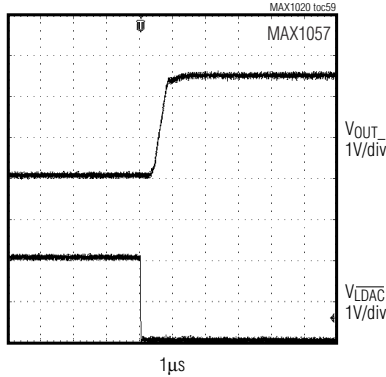

**POSITIVE FULL-SCALE SETTLING TIME  $R_{LOAD} = 10k\Omega$ ,  $C_{LOAD} = 100pF$**

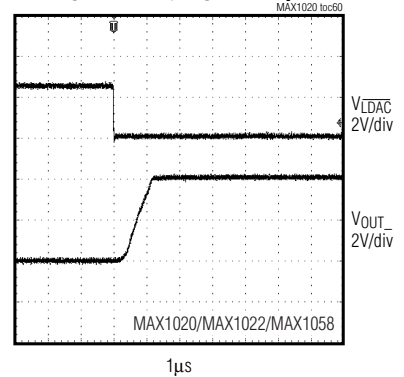

**ADC REFERENCE FEEDTHROUGH  $R_{LOAD} = 10k\Omega$ ,  $C_{LOAD} = 100pF$**

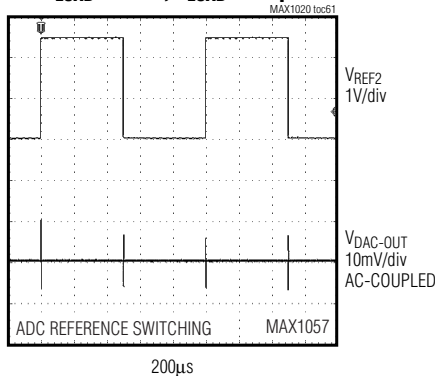

**ADC REFERENCE FEEDTHROUGH  $R_{LOAD} = 10k\Omega$ ,  $C_{LOAD} = 100pF$**

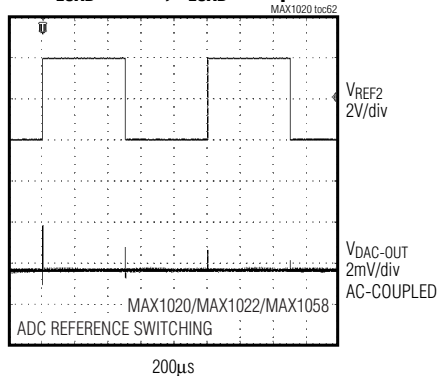

MAX1020/MAX1022/MAX1057/MAX1058

# 10-Bit, Multichannel ADCs/DACs with FIFO, Temperature Sensing, and GPIO Ports

## Pin Description

MAX1020/MAX1022/MAX1057/MAX1058

MAX1020	MAX1022	MAX1057/ MAX1058	NAME	FUNCTION
1, 2	—	—	GPIOA0, GPIOA1	General-Purpose I/O A0, A1. GPIOA0, A1 can sink and source 15mA.
3	3	4	$\overline{\text{EOC}}$	Active-Low End-of-Conversion Output. Data is valid after the falling edge of $\overline{\text{EOC}}$ .
4	4	7	DVDD	Digital Positive-Power Input. Bypass DVDD to DGND with a 0.1 $\mu$ F capacitor.
5	5	8	DGND	Digital Ground. Connect DGND to AGND.
6	6	9	DOUT	Serial-Data Output. Data is clocked out on the falling edge of the SCLK clock in modes 00, 01, and 10. Data is clocked out on the rising edge of the SCLK clock in mode 11. It is high impedance when $\overline{\text{CS}}$ is high.
7	7	10	SCLK	Serial-Clock Input. Clocks data in and out of the serial interface. (Duty cycle must be 40% to 60%.) See Table 5 for details on programming the clock mode.
8	8	11	DIN	Serial-Data Input. DIN data is latched into the serial interface on the falling edge of SCLK.
9–12, 16–19	9–12, 16–19	12–15, 22–25	OUT0–OUT7	DAC Outputs
13	13	18	AVDD	Positive Analog Power Input. Bypass AVDD to AGND with a 0.1 $\mu$ F capacitor.
14	14	19	AGND	Analog Ground
15, 23, 32, 33	2, 15, 24, 32, 32	—	N.C.	No Connection. Not internally connected.
20	20	26	$\overline{\text{LDAC}}$	Active-Low Load DAC. $\overline{\text{LDAC}}$ is an asynchronous active-low input that updates the DAC outputs. Drive $\overline{\text{LDAC}}$ low to make the DAC registers transparent.
21	21	27	$\overline{\text{CS}}$	Active-Low Chip-Select Input. When $\overline{\text{CS}}$ is low, the serial interface is enabled. When $\overline{\text{CS}}$ is high, DOUT is high impedance.
22	22	28	RES_SEL	Reset Select. Select DAC wake-up mode. Set RES_SEL low to wake up the DAC outputs with a 100k $\Omega$ resistor to GND or set RES_SEL high to wake up the DAC outputs with a 100k $\Omega$ resistor to V <sub>REF</sub> . Set RES_SEL high to power up the DAC input register to FFFh. Set RES_SEL low to power up the DAC input register to 000h.
24, 25	—	—	GPIOC0, GPIOC1	General-Purpose I/O C0, C1. GPIOC0, C1 can sink 4mA and source 2mA.



# 10-Bit, Multichannel ADCs/DACs with FIFO, Temperature Sensing, and GPIO Ports

## Pin Description (continued)

MAX1020	MAX1022	MAX1057/ MAX1058	NAME	FUNCTION
26	26	35	REF1	Reference 1 Input. Reference voltage; leave unconnected to use the internal reference (2.5V for the MAX1057 or 4.096V for the MAX1020/MAX1022/MAX1058). REF1 is the positive reference in ADC external differential reference mode. Bypass REF1 to AGND with a 0.1μF capacitor in external reference mode only. See the <i>ADC/DAC References</i> section.
27–31, 34	—	—	AIN0–AIN5	Analog Inputs
35	—	—	REF2/AIN6	Reference 2 Input/Analog-Input Channel 6. See Table 5 for details on programming the setup register. REF2 is the negative reference in the ADC external differential reference.
36	—	—	$\overline{\text{CNVST}}$ /AIN7	Active-Low Conversion-Start Input/Analog Input 7. See Table 5 for details on programming the setup register.
—	1	—	$\overline{\text{CNVST}}$ /AIN11	Active-Low Conversion-Start Input/Analog Input 11. See Table 5 for details on programming the setup register.
—	23, 25, 27–31, 33, 34, 35	—	AIN0–AIN9	Analog Inputs
—	36	—	REF2/AIN10	Reference 2 Input/Analog-Input Channel 10. See Table 5 for details on programming the setup register. REF2 is the negative reference in the ADC external differential reference.
—	—	1	$\overline{\text{CNVST}}$ /AIN15	Active-Low Conversion-Start Input/Analog Input 15. See Table 5 for details on programming the setup register.
—	—	2, 3, 5, 6	GPIOA0–GPIOA3	General-Purpose I/O A0–A3. GPIOA0–GPIOA3 can sink and source 15mA.
—	—	16, 17, 20, 21	GPIOB0–GPIOB3	General-Purpose I/O B0–B3. GPIOB0–GPIOB3 can sink 4mA and source 2mA.
—	—	29–32	GPIOC0–GPIOC3	General-Purpose I/O C0–C3. GPIOC0–GPIOC3 can sink 4mA and source 2mA.
—	—	33, 34, 36–47	AIN0–AIN13	Analog Inputs
—	—	48	REF2/AIN14	Reference 2 Input/Analog-Input Channel 14. See Table 5 for details on programming the setup register. REF2 is the negative reference in the ADC external differential reference.
—	—	—	EP	Exposed Paddle. Must be externally connected to AGND. Do not use as a ground connect.

MAX1020/MAX1022/MAX1057/MAX1058

# 10-Bit, Multichannel ADCs/DACs with FIFO, Temperature Sensing, and GPIO Ports

## Detailed Description

The MAX1020/MAX1022/MAX1057/MAX1058 integrate a multichannel, 10-bit ADC and an octal, 10-bit DAC in a single IC. These devices also include a temperature sensor and configurable GPIOs with a 25MHz SPI-/QSPI-/MICROWIRE-compatible serial interface. The ADC is available in 8/12/16 input-channel versions. The octal DAC outputs settle within 2.0 $\mu$ s, and the ADC has a 225ksp/s conversion rate.

All devices include an internal reference (2.5V or 4.096V) providing a well-regulated, low-noise reference for both the ADC and DAC. Programmable reference modes for the ADC and DAC allow the use of an internal reference, an external reference, or a combination of both. Features such as an internal  $\pm 1^{\circ}\text{C}$  accurate temperature sensor, FIFO, scan modes, programmable internal or external clock modes, data averaging, and AutoShutdown allow users to minimize both power consumption and processor requirements. The low glitch energy (4nV $\cdot$ s) and low digital feedthrough (0.5nV $\cdot$ s) of the integrated octal DACs make these devices ideal for digital control of fast-response closed-loop systems.

The devices are guaranteed to operate with a supply voltage from +2.7V to +3.6V (MAX1057) and from +4.5V to +5.5V (MAX1020/MAX1022/MAX1058), they consume 25mA at 225ksp/s throughput, only 22 $\mu$ A at 1ksp/s throughput, and under 0.2 $\mu$ A in the shutdown mode. The MAX1057/MAX1058 feature 12 GPIOs, while the MAX1020 offers four GPIOs that can be configured as inputs or outputs.

Figure 1 shows the MAX1057/MAX1058 functional diagram. The MAX1020 only includes the GPIOA0, GPIOA1 and GPIOC0, GPIOC1 block. The MAX1022 excludes the GPIOs. The output-conditioning circuitry takes the internal parallel data bus and converts it to a serial data format at DOUT, with the appropriate wake-up timing. The arithmetic logic unit (ALU) performs the averaging function.

### SPI-Compatible Serial Interface

The MAX1020/MAX1022/MAX1057/MAX1058 feature a serial interface that is compatible with SPI and MICROWIRE devices. For SPI, ensure the SPI bus master (typically a microcontroller ( $\mu$ C)) runs in master mode so that it generates the serial clock signal. Select the SCLK frequency of 25MHz or less, and set the clock polarity (CPOL) and phase (CPHA) in the  $\mu$ C control registers to the same value. The MAX1020/MAX1022/MAX1057/MAX1058 operate with SCLK idling high or low, and thus operate with CPOL = CPHA = 0 or

CPOL = CPHA = 1. Set  $\overline{\text{CS}}$  low to latch any input data at DIN on the falling edge of SCLK. Output data at DOUT is updated on the falling edge of SCLK in clock modes 00, 01, and 10. Output data at DOUT is updated on the rising edge of SCLK in clock mode 11. See Figures 6–11. Bipolar true-differential results and temperature-sensor results are available in two's complement format, while all other results are in binary.

A high-to-low transition on  $\overline{\text{CS}}$  initiates the data-input operation. Serial communications to the ADC always begin with an 8-bit command byte (MSB first) loaded from DIN. The command byte and the subsequent data bytes are clocked from DIN into the serial interface on the falling edge of SCLK. The serial-interface and fast-interface circuitry is common to the ADC, DAC, and GPIO sections. The content of the command byte determines whether the SPI port should expect 8, 16, or 24 bits and whether the data is intended for the ADC, DAC, or GPIOs (if applicable). See Table 1. Driving  $\overline{\text{CS}}$  high resets the serial interface.

The conversion register controls ADC channel selection, ADC scan mode, and temperature-measurement requests. See Table 4 for information on writing to the conversion register. The setup register controls the clock mode, reference, and unipolar/bipolar ADC configuration. Use a second byte, following the first, to write to the unipolar-mode or bipolar-mode registers. See Table 5 for details of the setup register and see Tables 6, 7, and 8 for setting the unipolar- and bipolar-mode registers. Hold  $\overline{\text{CS}}$  low between the command byte and the second and third byte. The ADC averaging register is specific to the ADC. See Table 9 to address that register. Table 11 shows the details of the reset register.

Begin a write to the DAC by writing 0001XXXX as a command byte. The last 4 bits of this command byte are don't-care bits. Write another 2 bytes (holding  $\overline{\text{CS}}$  low) to the DAC interface register following the command byte to select the appropriate DAC and the data to be written to it. See the *DAC Serial Interface* section and Tables 10, 20, and 21.

Write to the GPIOs (if applicable) by issuing a command byte to the appropriate register. Writing to the MAX1020 GPIOs requires 1 additional byte following the command byte. Writing to the MAX1057/MAX1058 requires 2 additional bytes following the command byte. See Tables 12–19 for details on GPIO configuration, writes, and reads. See the *GPIO Command* section. Command bytes written to the GPIOs on devices without GPIOs are ignored.

# 10-Bit, Multichannel ADCs/DACs with FIFO, Temperature Sensing, and GPIO Ports

MAX1020/MAX1022/MAX1057/MAX1058

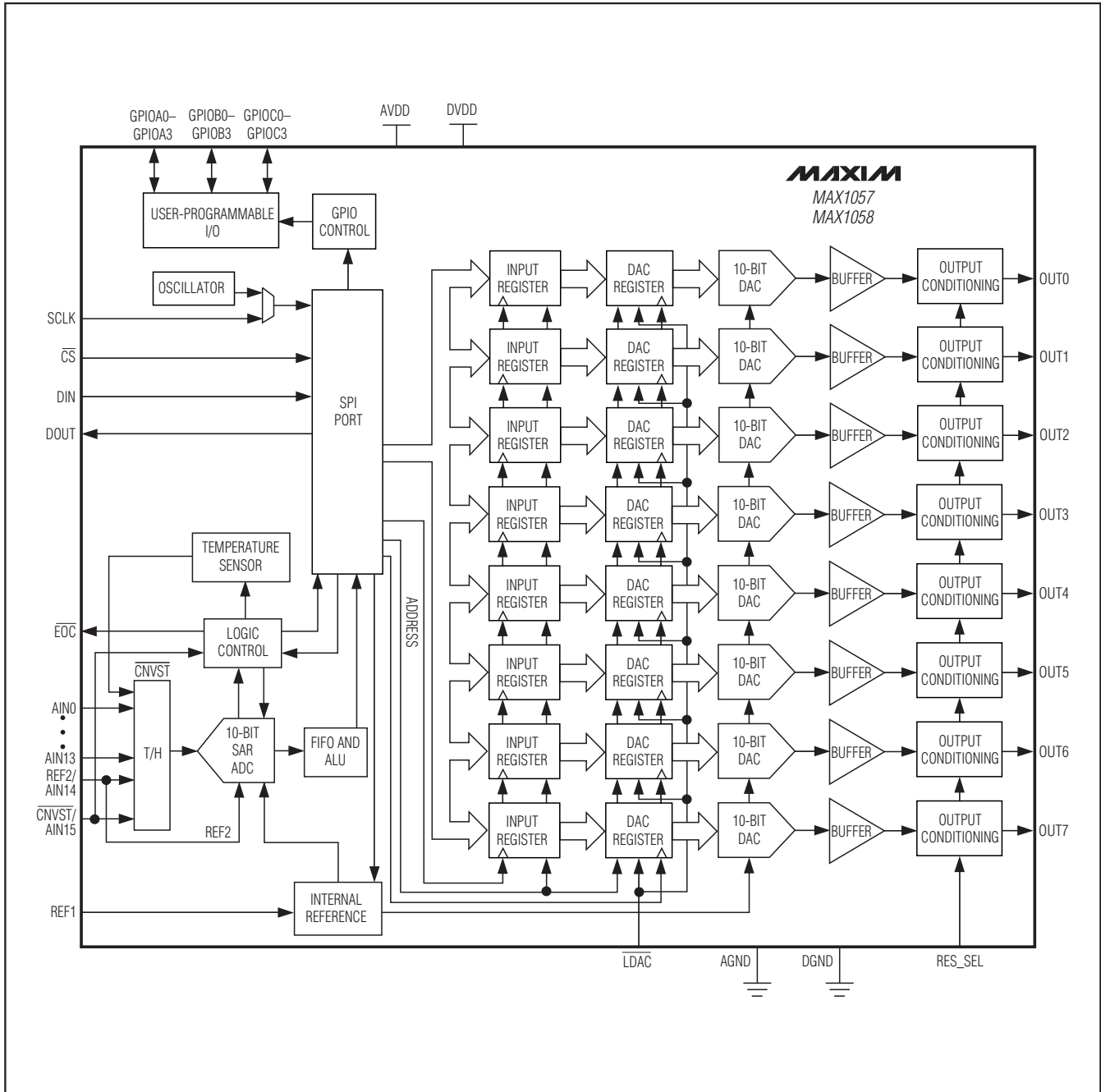

Figure 1. MAX1057/MAX1058 Functional Diagram

# 10-Bit, Multichannel ADCs/DACs with FIFO, Temperature Sensing, and GPIO Ports

Table 1. Command Byte (MSB First)

REGISTER NAME	BIT 7	BIT 6	BIT 5	BIT 4	BIT 3	BIT 2	BIT 1	BIT 0
Conversion	1	CHSEL3	CHSEL2	CHSEL1	CHSEL0	SCAN1	SCAN0	TEMP
Setup	0	1	CKSEL1	CKSEL0	REFSEL1	REFSEL0	DIFFSEL1	DIFFSEL0
ADC Averaging	0	0	1	AVGON	NAV1	NAV0	NSCAN1	NSCAN0
DAC Select	0	0	0	1	X	X	X	X
Reset	0	0	0	0	1	RESET	SLOW	FBGON
GPIO Configure*	0	0	0	0	0	0	1	1
GPIO Write*	0	0	0	0	0	0	1	0
GPIO Read*	0	0	0	0	0	0	0	1
No Operation	0	0	0	0	0	0	0	0

X = Don't care.

\*Only applicable on the MAX1020/MAX1057/MAX1058.

### Power-Up Default State

The MAX1020/MAX1022/MAX1057/MAX1058 power up with all blocks in shutdown (including the reference). All registers power up in state 00000000, except for the setup register and the DAC input register. The setup register powers up at 0010 1000 with CKSEL1 = 1 and REFSEL1 = 1. The DAC input register powers up to 3FFh when RES\_SEL is high and it powers up to 000h when RES\_SEL is low.

### 10-Bit ADC

The MAX1020/MAX1022/MAX1057/MAX1058 ADCs use a fully differential successive-approximation register (SAR) conversion technique and on-chip track-and-hold (T/H) circuitry to convert temperature and voltage signals into 10-bit digital results. The analog inputs accept both single-ended and differential input signals. Single-ended signals are converted using a unipolar transfer function, and differential signals are converted using a selectable bipolar or unipolar transfer function. See the *ADC Transfer Functions* section for more data.

### ADC Clock Modes

When addressing the setup, register bits 5 and 4 of the command byte (CKSEL1 and CKSEL0, respectively) control the ADC clock modes. See Table 5. Choose between four different clock modes for various ways to start a conversion and determine whether the acquisitions are internally or externally timed. Select clock mode 00 to configure  $\overline{\text{CNVST}}$ /AIN\_ to act as a conversion start and use it to request internally timed conversions, without tying up the serial bus. In clock mode 01, use  $\overline{\text{CNVST}}$  to request conversions one channel at a time, thereby controlling the sampling speed without tying up the serial bus. Request and start internally timed conversions through the serial interface by writ-

ing to the conversion register in the default clock mode, 10. Use clock mode 11 with SCLK up to 3.6MHz for externally timed acquisitions to achieve sampling rates up to 225ksps. Clock mode 11 disables scanning and averaging. See Figures 6–9 for timing specifications on how to begin a conversion.

These devices feature an active-low, end-of-conversion output.  $\overline{\text{EOC}}$  goes low when the ADC completes the last requested operation and is waiting for the next command byte.  $\overline{\text{EOC}}$  goes high when CS or  $\overline{\text{CNVST}}$  go low.  $\overline{\text{EOC}}$  is always high in clock mode 11.

### Single-Ended or Differential Conversions

The MAX1020/MAX1022/MAX1057/MAX1058 use a fully differential ADC for all conversions. When a pair of inputs are connected as a differential pair, each input is connected to the ADC. When configured in single-ended mode, the positive input is the single-ended channel and the negative input is referred to AGND. See Figure 2.

In differential mode, the T/H samples the difference between two analog inputs, eliminating common-mode DC offsets and noise. IN+ and IN- are selected from the following pairs: AIN0/AIN1, AIN2/AIN3, AIN4/AIN5, AIN6/AIN7, AIN8/AIN9, AIN10/AIN11, AIN12/AIN13, AIN14/AIN15. AIN0–AIN7 are available on all devices. AIN0–AIN11 are available on the MAX1022. AIN0–AIN15 are available on the MAX1057/MAX1058. See Tables 5–8 for more details on configuring the inputs. For the inputs that are configurable as  $\overline{\text{CNVST}}$ , REF2, and an analog input, only one function can be used at a time.

# 10-Bit, Multichannel ADCs/DACs with FIFO, Temperature Sensing, and GPIO Ports

## Unipolar or Bipolar Conversions

Address the unipolar- and bipolar-mode registers through the setup register (bits 1 and 0). See Table 5 for the setup register. See Figures 3 and 4 for the transfer-function graphs. Program a pair of analog inputs for differential operation by writing a one to the appropriate bit of the bipolar- or unipolar-mode register. Unipolar mode sets the differential input range from 0 to  $V_{REF1}$ . A negative differential analog input in unipolar mode causes the digital output code to be zero. Selecting bipolar mode sets the differential input range to  $\pm V_{REF1} / 2$ . The digital output code is binary in unipolar mode and two's complement in bipolar mode.

In single-ended mode, the MAX1020/MAX1022/MAX1057/MAX1058 always operate in unipolar mode. The analog inputs are internally referenced to AGND with a full-scale input range from 0 to the selected reference voltage.

## Analog Input (T/H)

The equivalent circuit of Figure 2 shows the ADC input architecture of the MAX1020/MAX1022/MAX1057/MAX1058. In track mode, a positive input capacitor is connected to AIN0–AIN15 in single-ended mode and AIN0, AIN2, and AIN4–AIN14 (only positive inputs) in differential mode. A negative input capacitor is connected to AGND in single-ended mode or AIN1, AIN3, and AIN5–AIN15 (only negative inputs) in differential mode. For external T/H timing, use clock mode 01. After the T/H enters hold mode, the difference between the sampled positive and negative input voltages is con-

verted. The input capacitance charging rate determines the time required for the T/H to acquire an input signal. If the input signal's source impedance is high, the required acquisition time lengthens.

Any source impedance below  $300\Omega$  does not significantly affect the ADC's AC performance. A high-impedance source can be accommodated either by lengthening  $t_{ACQ}$  (only in clock mode 01) or by placing a  $1\mu\text{F}$  capacitor between the positive and negative analog inputs. The combination of the analog-input source impedance and the capacitance at the analog input creates an RC filter that limits the analog input bandwidth.

## Input Bandwidth

The ADC's input-tracking circuitry has a 1MHz small-signal bandwidth, making it is possible to digitize high-speed transient events and measure periodic signals with bandwidths exceeding the ADC's sampling rate by using undersampling techniques. Anti-alias prefiltering of the input signals is necessary to avoid high-frequency signals aliasing into the frequency band of interest.

## Analog-Input Protection

Internal electrostatic-discharge (ESD) protection diodes clamp all analog inputs to  $V_{AVDD}$  and AGND, allowing the inputs to swing from  $(V_{AGND} - 0.3\text{V})$  to  $(V_{AVDD} + 0.3\text{V})$  without damage. However, for accurate conversions near full scale, the inputs must not exceed  $V_{AVDD}$  by more than 50mV or be lower than AGND by 50mV. If an analog input voltage exceeds the supplies, limit the input current to 2mA.

## Internal FIFO

The MAX1020/MAX1022/MAX1057/MAX1058 contain a first-in/first-out (FIFO) buffer that holds up to 16 ADC results plus one temperature result. The internal FIFO allows the ADC to process and store multiple internally clocked conversions and a temperature measurement without being serviced by the serial bus.

If the FIFO is filled and further conversions are requested without reading from the FIFO, the oldest ADC results are overwritten by the new ADC results. Each result contains 2 bytes, with the MSB preceded by four leading zeros and the LSB followed by 2 sub-bits. After each falling edge of  $\overline{\text{CS}}$ , the oldest available pair of bytes of data is available at DOUT, MSB first. When the FIFO is empty, DOUT is zero.

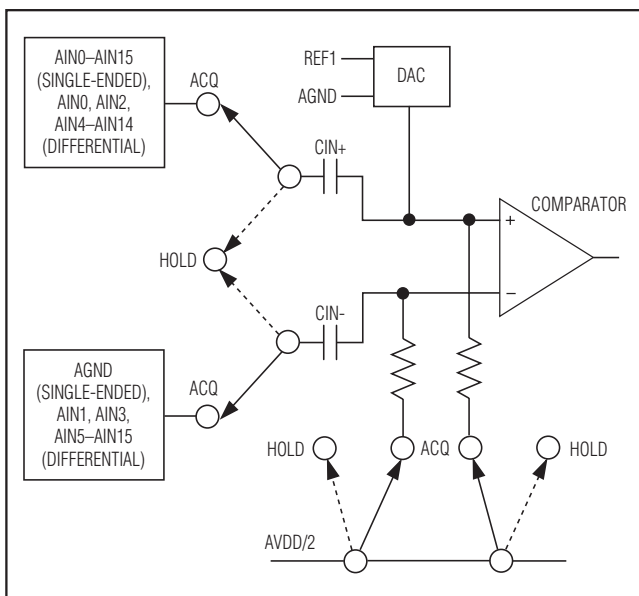

Figure 2. Equivalent Input Circuit

# 10-Bit, Multichannel ADCs/DACs with FIFO, Temperature Sensing, and GPIO Ports

The first 2 bytes of data read out after a temperature measurement always contain the 12-bit temperature result, preceded by four leading zeros, MSB first. If another temperature measurement is performed before the first temperature result is read out, the old measurement is overwritten by the new result. Temperature results are in degrees Celsius (two's complement), at a resolution of 8 LSB per degree. See the *Temperature Measurements* section for details on converting the digital code to a temperature.

## 10-Bit DAC

In addition to the 10-bit ADC, the MAX1020/MAX1022/MAX1057/MAX1058 also include eight voltage-output, 10-bit, monotonic DACs with less than 4 LSB integral nonlinearity error and less than 1 LSB differential nonlinearity error. Each DAC has a 2 $\mu$ s settling time and ultra-low glitch energy (4nV•s). The 10-bit DAC code is unipolar binary with 1 LSB =  $V_{REF} / 4096$ .

## DAC Digital Interface

Figure 1 shows the functional diagram of the MAX1057/MAX1058. The shift register converts a serial 16-bit word to parallel data for each input register operating with a clock rate up to 25MHz. The SPI-compatible digital interface to the shift register consists of  $\overline{CS}$ , SCLK, DIN, and DOUT. Serial data at DIN is loaded on the falling edge of SCLK. Pull  $\overline{CS}$  low to begin a write sequence. Begin a write to the DAC by writing 0001XXXX as a command byte. The last 4 bits of the DAC select register are don't-care bits. See Table 10. Write another 2 bytes to the DAC interface register following the command byte to select the appropriate DAC and the data to be written to it. See Tables 20 and 21.

The eight double-buffered DACs include an input and a DAC register. The input registers are directly connected to the shift register and hold the result of the most recent write operation. The eight 10-bit DAC registers hold the current output code for the respective DAC. Data can be transferred from the input registers to the DAC registers by pulling  $\overline{LDAC}$  low or by writing the appropriate DAC command sequence at DIN. See Table 20. The outputs of the DACs are buffered through eight rail-to-rail op amps.

The MAX1020/MAX1022/MAX1057/MAX1058 DAC output-voltage range is based on the internal reference or an external reference. Write to the setup register (see Table 5) to program the reference. If using an external voltage reference, bypass REF1 with a 0.1 $\mu$ F capacitor to AGND. The MAX1057 internal reference is 2.5V. The MAX1020/MAX1022/MAX1058 internal reference is

4.096V. When using an external reference on any of these devices, the voltage range is 0.7V to  $V_{AVDD}$ .

## DAC Transfer Function

See Table 2 for various analog outputs from the DAC.

## DAC Power-On Wake-Up Modes

The state of the RES\_SEL input determines the wake-up state of the DAC outputs. Connect RES\_SEL to AVDD or AGND upon power-up to be sure the DAC outputs wake up to a known state. Connect RES\_SEL to AGND to wake up all DAC outputs at 000h. While RES\_SEL is low, the 100k $\Omega$  internal resistor pulls the DAC outputs to AGND and the output buffers are powered down. Connect RES\_SEL to AVDD to wake up all DAC outputs at 3FFh. While RES\_SEL is high, the 100k $\Omega$  pullup resistor pulls the DAC outputs to  $V_{REF1}$  and the output buffers are powered down.

## DAC Power-Up Modes

See Table 21 for a description of the DAC power-up and power-down modes.

## GPIOs

In addition to the internal ADC and DAC, the MAX1057/MAX1058 also provide 12 general-purpose input/output channels, GPIOA0–GPIOA3, GPIOB0–GPIOB3, and GPIOC0–GPIOC3. The MAX1020 includes four GPIO channels (GPIOA0, GPIOA1, GPIOC0,

**Table 2. DAC Output Code Table**

DAC CONTENTS			ANALOG OUTPUT
MSB	LSB		
11	1111	1111	$+V_{REF} \left( \frac{1023}{1024} \right)$
10	0000	0001	$+V_{REF} \left( \frac{513}{1024} \right)$
10	0000	0000	$+V_{REF} \left( \frac{512}{1024} \right) = \left( \frac{+V_{REF}}{2} \right)$
01	0111	0111	$+V_{REF} \left( \frac{511}{1024} \right)$
00	0000	0001	$+V_{REF} \left( \frac{1}{1024} \right)$
00	0000	0000	0

# 10-Bit, Multichannel ADCs/DACs with FIFO, Temperature Sensing, and GPIO Ports

GPIOC1). Read and write to the GPIOs as detailed in Table 1 and Tables 12–19. Also, see the *GPIO Command* section. See Figures 11 and 12 for GPIO timing.

Write to the GPIOs by writing a command byte to the GPIO command register. Write a single data byte to the MAX1020 following the command byte. Write 2 bytes to the MAX1057/MAX1058 following the command byte.

The GPIOs can sink and source current. The MAX1057/MAX1058 GPIOA0–GPIOA3 can sink and source up to 15mA. GPIOB0–GPIOB3 and GPIOC0–GPIOC3 can sink 4mA and source 2mA. The MAX1020 GPIOA0 and GPIOA1 can sink and source up to 15mA. The MAX1020 GPIOC0 and GPIOC1 can sink 4mA and source 2mA. See Table 3.

## Clock Modes

### Internal Clock

The MAX1020/MAX1022/MAX1057/MAX1058 can operate from an internal oscillator. The internal oscillator is active in clock modes 00, 01, and 10. Figures 6, 7, and 8 show how to start an ADC conversion in the three internally timed conversion modes.

Read out the data at clock speeds up to 25MHz through the SPI interface.

### External Clock

Set CKSEL1 and CKSEL0 in the setup register to 11 to set up the interface for external clock mode 11. See Table 5. Pulse SCLK at speeds from 0.1MHz to 3.6MHz. Write to SCLK with a 40% to 60% duty cycle. The SCLK frequency controls the conversion timing. See Figure 9 for clock mode 11 timing. See the *ADC Conversions in Clock Mode 11* section.

## ADC/DAC References

Address the reference through the setup register, bits 3 and 2. See Table 5. Following a wake-up delay, set REFSEL[1:0] = 00 to program both the ADC and DAC for internal reference use. Set REFSEL[1:0] = 10 to program the ADC for internal reference. Set REFSEL[1:0] = 10 to program the DAC for external reference, REF1. When using REF1 or REF2/AIN\_ in external-reference mode, connect a 0.1µF capacitor to AGND. Set REFSEL[1:0] = 01 to program the ADC and DAC for external-reference mode. The DAC uses REF1 as its external reference, while the ADC uses REF2 as its external ref-

erence. Set REFSEL[1:0] = 11 to program the ADC for external differential reference mode. REF1 is the positive reference and REF2 is the negative reference in the ADC external differential mode.

When REFSEL [1:0] = 00 or 10, REF2/AIN\_ functions as an analog input channel. When REFSEL [1:0] = 01 or 11, REF2/AIN\_ functions as the device's negative reference.

## Temperature Measurements

Issue a command byte setting bit 0 of the conversion register to one to take a temperature measurement. See Table 4. The MAX1020/MAX1022/MAX1057/MAX1058 perform temperature measurements with an internal diode-connected transistor. The diode bias current changes from 68µA to 4µA to produce a temperature-dependent bias voltage difference. The second conversion result at 4µA is subtracted from the first at 68µA to calculate a digital value that is proportional to absolute temperature. The output data appearing at DOUT is the digital code above, minus an offset to adjust from Kelvin to Celsius.

The reference voltage used for the temperature measurements is always derived from the internal reference source to ensure that 1 LSB corresponds to 1/8 of a degree Celsius. On every scan where a temperature measurement is requested, the temperature conversion is carried out first. The first 2 bytes of data read from the FIFO contain the result of the temperature measurement. If another temperature measurement is performed before the first temperature result is read out, the old measurement is overwritten by the new result. Temperature results are in degrees Celsius (two's complement). See the *Applications Information* section for information on how to perform temperature measurements in each clock mode.

## Register Descriptions

The MAX1020/MAX1022/MAX1057/MAX1058 communicate between the internal registers and the external circuitry through the SPI-compatible serial interface. Table 1 details the command byte, the registers, and the bit names. Tables 4–12 show the various functions within the conversion register, setup register, unipolar-mode register, bipolar-mode register, ADC averaging register, DAC select register, reset register, and GPIO command register, respectively.

**Table 3. GPIO Maximum Sink/Source Current**

CURRENT	MAX1057/MAX1058 (mA)			MAX1020 (mA)	
	GPIOA0–GPIOA3	GPIOB0–GPIOB3	GPIOC0–GPIOC3	GPIOA0, GPIOA1	GPIOC0, GPIOC1
SINK	15	4	4	15	4
SOURCE	15	2	2	15	2

# 10-Bit, Multichannel ADCs/DACs with FIFO, Temperature Sensing, and GPIO Ports

## Conversion Register

Select active analog input channels, scan modes, and a single temperature measurement per scan by issuing a command byte to the conversion register. Table 4 details channel selection, the four scan modes, and how to request a temperature measurement. Start a scan by writing to the conversion register when in clock mode 10 or 11, or by applying a low pulse to the  $\overline{\text{CNVST}}$  pin when in clock mode 00 or 01. See Figures 6 and 7 for timing specifications for starting a scan with  $\overline{\text{CNVST}}$ .

A conversion is not performed if it is requested on a channel or one of the channel pairs that has been configured as  $\overline{\text{CNVST}}$  or REF2. For channels configured as differential pairs, the CHSEL0 bit is ignored and the two pins are treated as a single differential channel.

Select scan mode 00 or 01 to return one result per single-ended channel and one result per differential pair within the selected scanning range (set by bits 2 and 1, SCAN1 and SCAN0), plus one temperature result if selected. Select scan mode 10 to scan a single input channel numerous times, depending on NSCAN1 and NSCAN0 in the ADC averaging register (Table 9). Select scan mode 11 to return only one result from a single channel.

## Setup Register

Issue a command byte to the setup register to configure the clock, reference, power-down modes, and ADC single-ended/differential modes. Table 5 details the bits in the setup-register command byte. Bits 5 and 4 (CKSEL1 and CKSEL0) control the clock mode, acquisition and sampling, and the conversion start. Bits 3 and 2 (REFSEL1 and REFSEL0) set the device for either internal or external reference. Bits 1 and 0 (DIFFSEL1 and DIFFSEL0) address the ADC unipolar-mode and bipolar-mode registers and configure the analog-input channels for differential operation.

The ADC reference is always on if any of the following conditions are true:

- 1) The FBGON bit is set to one in the reset register.
- 2) At least one DAC output is powered up and REFSEL[1:0] (in the setup register) = 00.
- 3) At least one DAC is powered down through the 100k $\Omega$  to VREF and REFSEL[1:0] = 00.

Table 4. Conversion Register\*

BIT NAME	BIT	FUNCTION
—	7 (MSB)	Set to one to select conversion register.
CHSEL3	6	Analog-input channel select.
CHSEL2	5	Analog-input channel select.
CHSEL1	4	Analog-input channel select.
CHSEL0	3	Analog-input channel select.
SCAN1	2	Scan-mode select.
SCAN0	1	Scan-mode select.
TEMP	0 (LSB)	Set to one to take a single temperature measurement. The first conversion result of a scan contains temperature information.

\*See below for bit details.

CHSEL3	CHSEL2	CHSEL1	CHSEL0	SELECTED CHANNEL (N)
0	0	0	0	AIN0
0	0	0	1	AIN1
0	0	1	0	AIN2
0	0	1	1	AIN3
0	1	0	0	AIN4
0	1	0	1	AIN5
0	1	1	0	AIN6
0	1	1	1	AIN7
1	0	0	0	AIN8
1	0	0	1	AIN9
1	0	1	0	AIN10
1	0	1	1	AIN11
1	1	0	0	AIN12
1	1	0	1	AIN13
1	1	1	0	AIN14
1	1	1	1	AIN15

SCAN1	SCAN0	SCAN MODE (CHANNEL N IS SELECTED BY BITS CHSEL3–CHSEL0)
0	0	Scans channels 0 through N.
0	1	Scans channels N through the highest numbered channel.
1	0	Scans channel N repeatedly. The ADC averaging register sets the number of results.
1	1	No scan. Converts channel N once only.



# 10-Bit, Multichannel ADCs/DACs with FIFO, Temperature Sensing, and GPIO Ports

MAX1020/MAX1022/MAX1057/MAX1058

**Table 5. Setup Register\***

BIT NAME	BIT	FUNCTION
—	7 (MSB)	Set to zero to select setup register.
—	6	Set to one to select setup register.
CKSEL1	5	Clock mode and $\overline{\text{CNVST}}$ configuration; resets to one at power-up.
CKSEL0	4	Clock mode and $\overline{\text{CNVST}}$ configuration.
REFSEL1	3	Reference-mode configuration.
REFSEL0	2	Reference-mode configuration.
DIFFSEL1	1	Unipolar-/bipolar-mode register configuration for differential mode.
DIFFSEL0	0 (LSB)	Unipolar-/bipolar-mode register configuration for differential mode.

\*See below for bit details.

**Table 5a. Clock Modes (see the *Clock Mode* section)**

CKSEL1	CKSEL0	CONVERSION CLOCK	ACQUISITION/SAMPLING	$\overline{\text{CNVST}}$ CONFIGURATION
0	0	Internal	Internally timed.	$\overline{\text{CNVST}}$
0	1	Internal	Externally timed by $\overline{\text{CNVST}}$ .	$\overline{\text{CNVST}}$
1	0	Internal	Internally timed.	AIN15/AIN11/AIN7
1	1	External (3.6MHz max)	Externally timed by SCLK.	AIN15/AIN11/AIN7

**Table 5b. Clock Modes 00, 01, and 10**

REFSEL1	REFSEL0	VOLTAGE REFERENCE	OVERRIDE CONDITIONS	AUTOSHUTDOWN	REF2 CONFIGURATION
0	0	Internal (DAC and ADC)	AIN	Internal reference turns off after scan is complete. If internal reference is turned off, there is a programmed delay of 218 internal-conversion clock cycles.	AIN14/AIN10/AIN6
			Temperature	Internal reference required. There is a programmed delay of 244 internal-conversion clock cycles for the internal reference to settle after wake-up.	
0	1	External single-ended (REF1 for DAC and REF2 for ADC)	AIN	Internal reference not used.	REF2
			Temperature	Internal reference required. There is a programmed delay of 244 internal-conversion clock cycles for the internal reference to settle after wake-up.	
1	0	Internal (ADC) and external REF1 (DAC)	AIN	Default reference mode. Internal reference turns off after scan is complete. If internal reference is turned off, there is a programmed delay of 218 internal-conversion clock cycles.	AIN14/AIN10/AIN6
			Temperature	Internal reference required. There is a programmed delay of 244 internal-conversion clock cycles for the internal reference to settle after wake-up.	
1	1	External differential (ADC), external REF1 (DAC)	AIN	Internal reference not used.	REF2
			Temperature	Internal reference required. There is a programmed delay of 244 internal-conversion clock cycles for the internal reference to settle after wake-up.	

# 10-Bit, Multichannel ADCs/DACs with FIFO, Temperature Sensing, and GPIO Ports

If any of the above conditions exist, the ADC reference is always on, but there is a 188 clock-cycle delay before temperature-sensor measurements begin, if requested.

### Unipolar/Bipolar Registers

The final 2 bits (LSBs) of the setup register control the unipolar-/bipolar-mode address registers. Set DIFFSEL[1:0] = 10 to write to the unipolar-mode register. Set bits DIFFSEL[1:0] = 11 to write to the bipolar-mode register. In both cases, the setup command byte

**Table 5c. Clock Mode 11**

REFSEL1	REFSEL0	VOLTAGE REFERENCE	OVERRIDE CONDITIONS	AUTOSHUTDOWN	REF2 CONFIGURATION
0	0	Internal (DAC and ADC)	AIN	Internal reference turns off after scan is complete. If internal reference is turned off, there is a programmed delay of 218 external conversion clock cycles.	AIN14/AIN10/AIN6
			Temperature	Internal reference required. There is a programmed delay of 244 external conversion clock cycles for the internal reference. Temperature-sensor output appears at DOUT after 188 further external clock cycles.	
0	1	External single-ended (REF1 for DAC and REF2 for ADC)	AIN	Internal reference not used.	REF2
			Temperature	Internal reference required. There is a programmed delay of 244 external conversion clock cycles for the internal reference. Temperature-sensor output appears at DOUT after 188 further external clock cycles.	
1	0	Internal (ADC) and external REF1 (DAC)	AIN	Default reference mode. Internal reference turns off after scan is complete. If internal reference is turned off, there is a programmed delay of 218 external conversion clock cycles.	AIN14/AIN10/AIN6
			Temperature	Internal reference required. There is a programmed delay of 244 external conversion clock cycles for the internal reference. Temperature-sensor output appears at DOUT after 188 further external clock cycles.	
1	1	External differential (ADC), external REF1 (DAC)	AIN	Internal reference not used.	REF2
			Temperature	Internal reference required. There is a programmed delay of 244 external conversion clock cycles for the internal reference. Temperature-sensor output appears at DOUT after 188 further external clock cycles.	

**Table 5d. Differential Select Modes**

DIFFSEL1	DIFFSEL0	FUNCTION
0	0	No data follows the command setup byte. Unipolar-mode and bipolar-mode registers remain unchanged.
0	1	No data follows the command setup byte. Unipolar-mode and bipolar-mode registers remain unchanged.
1	0	1 byte of data follows the command setup byte and is written to the unipolar-mode register.
1	1	1 byte of data follows the command setup byte and is written to the bipolar-mode register.

# 10-Bit, Multichannel ADCs/DACs with FIFO, Temperature Sensing, and GPIO Ports

MAX1020/MAX1022/MAX1057/MAX1058

**Table 6. Unipolar-Mode Register (Addressed Through the Setup Register)**

BIT NAME	BIT	FUNCTION
UCH0/1	7 (MSB)	Configure AIN0 and AIN1 for unipolar differential conversion.
UCH2/3	6	Configure AIN2 and AIN3 for unipolar differential conversion.
UCH4/5	5	Configure AIN4 and AIN5 for unipolar differential conversion.
UCH6/7	4	Configure AIN6 and AIN7 for unipolar differential conversion.
UCH8/9	3	Configure AIN8 and AIN9 for unipolar differential conversion.
UCH10/11	2	Configure AIN10 and AIN11 for unipolar differential conversion.
UCH12/13	1	Configure AIN12 and AIN13 for unipolar differential conversion.
UCH14/15	0 (LSB)	Configure AIN14 and AIN15 for unipolar differential conversion.

**Table 7. Bipolar-Mode Register (Addressed Through the Setup Register)**

BIT NAME	BIT	FUNCTION
BCH0/1	7 (MSB)	Set to one to configure AIN0 and AIN1 for bipolar differential conversion. Set the corresponding bits in the unipolar-mode and bipolar-mode registers to zero to configure AIN0 and AIN1 for unipolar single-ended conversion.
BCH2/3	6	Set to one to configure AIN2 and AIN3 for bipolar differential conversion. Set the corresponding bits in the unipolar-mode and bipolar-mode registers to zero to configure AIN2 and AIN3 for unipolar single-ended conversion.
BCH4/5	5	Set to one to configure AIN4 and AIN5 for bipolar differential conversion. Set the corresponding bits in the unipolar-mode and bipolar-mode registers to zero to configure AIN4 and AIN5 for unipolar single-ended conversion.
BCH6/7	4	Set to one to configure AIN6 and AIN7 for bipolar differential conversion. Set the corresponding bits in the unipolar-mode and bipolar-mode registers to zero to configure AIN6 and AIN7 for unipolar single-ended conversion.
BCH8/9	3	Set to one to configure AIN8 and AIN9 for bipolar differential conversion. Set the corresponding bits in the unipolar-mode and bipolar-mode registers to zero to configure AIN8 and AIN9 for unipolar single-ended conversion.
BCH10/11	2	Set to one to configure AIN10 and AIN11 for bipolar differential conversion. Set the corresponding bits in the unipolar-mode and bipolar-mode registers to zero to configure AIN10 and AIN11 for unipolar single-ended conversion.
BCH12/13	1	Set to one to configure AIN12 and AIN13 for bipolar differential conversion. Set the corresponding bits in the unipolar-mode and bipolar-mode registers to zero to configure AIN12 and AIN13 for unipolar single-ended conversion.
BCH14/15	0 (LSB)	Set to one to configure AIN14 and AIN15 for bipolar differential conversion. Set the corresponding bits in the unipolar-mode and bipolar-mode registers to zero to configure AIN14 and AIN15 for unipolar single-ended conversion.

# 10-Bit, Multichannel ADCs/DACs with FIFO, Temperature Sensing, and GPIO Ports

must be followed by 1 byte of data that is written to the unipolar-mode register or bipolar-mode register. Hold  $\overline{CS}$  low and run 16 SCLK cycles before pulling  $\overline{CS}$  high. If the last 2 bits of the setup register are 00 or 01, neither the unipolar-mode register nor the bipolar-mode register is written. Any subsequent byte is recognized as a new command byte. See Tables 6, 7, and 8 to program the unipolar- and bipolar-mode registers.

Both registers power up at all zeros to set the inputs as 16 unipolar single-ended channels. To configure a channel pair as single-ended unipolar, bipolar differential, or unipolar differential, see Table 8.

In unipolar mode,  $A_{IN+}$  can exceed  $A_{IN-}$  by up to  $V_{REF}$ . The output format in unipolar mode is binary. In bipolar mode, either input can exceed the other by up to  $V_{REF}/2$ . The output format in bipolar mode is two's complement (see the *ADC Transfer Functions* section).

**Table 8. Unipolar/Bipolar Channel Function**

UNIPOLAR-MODE REGISTER BIT	BIPOLAR-MODE REGISTER BIT	CHANNEL PAIR FUNCTION
0	0	Unipolar single-ended
0	1	Bipolar differential
1	0	Unipolar differential
1	1	Unipolar differential

### ADC Averaging Register

Write a command byte to the ADC averaging register to configure the ADC to average up to 32 samples for each requested result, and to independently control the number of results requested for single-channel scans.

Table 9 details the four scan modes available in the ADC conversion register. All four scan modes allow averaging as long as the AVGON bit, bit 4 in the averaging register, is set to 1. Select scan mode 10 to scan the same channel multiple times. Clock mode 11

**Table 9. ADC Averaging Register\***

BIT NAME	BIT	FUNCTION
—	7 (MSB)	Set to zero to select ADC averaging register.
—	6	Set to zero to select ADC averaging register.
—	5	Set to one to select ADC averaging register.
AVGON	4	Set to one to turn averaging on. Set to zero to turn averaging off.
NAV1	3	Configures the number of conversions for single-channel scans.
NAV0	2	Configures the number of conversions for single-channel scans.
NSCAN1	1	Single-channel scan count. (Scan mode 10 only.)
NSCAN0	0 (LSB)	Single-channel scan count. (Scan mode 10 only.)

\*See below for bit details.

AVGON	NAV1	NAV0	FUNCTION
0	X	X	Performs one conversion for each requested result.
1	0	0	Performs four conversions and returns the average for each requested result.
1	0	1	Performs eight conversions and returns the average for each requested result.
1	1	0	Performs 16 conversions and returns the average for each requested result.
1	1	1	Performs 32 conversions and returns the average for each requested result.

NSCAN1	NSCAN0	FUNCTION (APPLIES ONLY IF SCAN MODE 10 IS SELECTED)
0	0	Scans channel N and returns four results.
0	1	Scans channel N and returns eight results.
1	0	Scans channel N and returns 12 results.
1	1	Scans channel N and returns 16 results.

# 10-Bit, Multichannel ADCs/DACs with FIFO, Temperature Sensing, and GPIO Ports

disables averaging. For example, if  $AVGON = 1$ ,  $NAV[1:0] = 00$ ,  $NSCAN[1:0] = 11$  and  $SCAN[1:0] = 10$ , 16 results are written to the FIFO, with each result being the average of four conversions of channel N.

### DAC Select Register

Write a command byte 0001XXXX to the DAC select register (as shown in Table 9) to set up the DAC interface and indicate that another word will follow. The last 4 bits of the DAC select register are don't-care bits. The word that follows the DAC select-register command byte controls the DAC serial interface. See Table 20 and the *DAC Serial Interface* section.

### Reset Register

Write to the reset register (as shown in Table 11) to clear the FIFO or reset all registers (excluding the DAC and GPIO registers) to their default states. When the

RESET bit in the reset register is set to 0, the FIFO is cleared. Set the RESET bit to one to return all the device registers to their default power-up state. All registers power up in state 00000000, except for the setup register that powers up in clock mode 10 ( $CKSEL1 = 1$  and  $REFSEL1 = 1$ ). The DAC and GPIO registers are not reset by writing to the reset register. Set the SLOW bit to one to add a 15ns delay in the DOUT signal path to provide a longer hold time. Writing a one to the SLOW bit also clears the contents of the FIFO. Set the FBGON bit to one to force the bias block and bandgap reference to power up regardless of the state of the DAC and activity of the ADC block. Setting the FBGON bit high also removes the programmed wake-up delay between conversions in clock modes 01 and 11. Setting the FBGON bit high also clears the FIFO.

### GPIO Command

Write a command byte to the GPIO command register to configure, write, or read the GPIOs, as detailed in Table 12.

Write the command byte 00000011 to configure the GPIOs. The eight SCLK cycles following the command byte load data from DIN to the GPIO configuration register in the MAX1020. The 16 SCLK cycles following the command byte load data from DIN to the GPIO configuration register in the MAX1057/MAX1058. See Tables 13 and 14. The register bits are updated after the last

**Table 10. DAC Select Register**

BIT NAME	BIT	FUNCTION
—	7 (MSB)	Set to zero to select DAC select register.
—	6	Set to zero to select DAC select register.
—	5	Set to zero to select DAC select register.
—	4	Set to one to select DAC select register.
X	3	Don't care.
X	2	Don't care.
X	1	Don't care.
X	0	Don't care.

**Table 11. Reset Register**

BIT NAME	BIT	FUNCTION
—	7 (MSB)	Set to zero to select ADC reset register.
—	6	Set to zero to select ADC reset register.
—	5	Set to zero to select ADC reset register.
—	4	Set to zero to select ADC reset register.
—	3	Set to one to select ADC reset register.
RESET	2	Set to zero to clear the FIFO only. Set to one to set the device in its power-on condition.
SLOW	1	Set to one to turn on slow mode.
FBGON	0 (LSB)	Set to one to force internal bias block and bandgap reference to be always powered up.

**Table 12. GPIO Command Register**

BIT NAME	BIT	FUNCTION
—	7 (MSB)	Set to zero to select GPIO register.
—	6	Set to zero to select GPIO register.
—	5	Set to zero to select GPIO register.
—	4	Set to zero to select GPIO register.
—	3	Set to zero to select GPIO register.
—	2	Set to zero to select GPIO register.
GPIOSEL1	1	GPIO configuration bit.
GPIOSEL2	0 (LSB)	GPIO write bit.

GPIOSEL1	GPIOSEL2	FUNCTION
1	1	GPIO configuration; written data is entered in the GPIO configuration register.
1	0	GPIO write; written data is entered in the GPIO write register.
0	1	GPIO read; the next 8/16 SCLK cycles transfer the state of all GPIO drivers into DOUT.

# 10-Bit, Multichannel ADCs/DACs with FIFO, Temperature Sensing, and GPIO Ports

$\overline{CS}$  rising edge. All GPIOs default to inputs upon power-up.

The data in the register controls the function of each GPIO, as shown in Tables 13–19.

### GPIO Write

Write the command byte 00000010 to indicate a GPIO write operation. The eight SCLK cycles following the command byte load data from DIN into the GPIO write register in the MAX1020. The 16 SCLK cycles following the command byte load data from DIN into the GPIO write register in the MAX1057/MAX1058. See Tables 15 and 16. The register bits are updated after the last  $\overline{CS}$  rising edge.

**Table 13. MAX1020 GPIO Configuration**

DATA PIN	GPIO COMMAND BYTE								DATA BYTE							
DIN	0	0	0	0	0	0	1	1	GPIOC1	GPIOC0	GPIOA1	GPIOA0	X	X	X	X
DOUT	0	0	0	0	0	0	0	0	0	0	0	0	0	0	0	0

**Table 14. MAX1057/MAX1058 GPIO Configuration**

DATA PIN	GPIO COMMAND BYTE								DATA BYTE 1								DATA BYTE 2							
DIN	0	0	0	0	0	0	1	1	GPIOC3	GPIOC2	GPIOC1	GPIOC0	GPIOB3	GPIOB2	GPIOB1	GPIOB0	GPIOA3	GPIOA2	GPIOA1	GPIOA0	X	X	X	X
DOUT	0	0	0	0	0	0	0	0	0	0	0	0	0	0	0	0	0	0	0	0	0	0	0	0

**Table 15. MAX1020 GPIO Write**

DATA PIN	GPIO COMMAND BYTE								DATA BYTE							
DIN	0	0	0	0	0	0	1	0	GPIOC1	GPIOC0	GPIOA1	GPIOA0	X	X	X	X
DOUT	0	0	0	0	0	0	0	0	0	0	0	0	0	0	0	0

**Table 16. MAX1057/MAX1058 GPIO Write**

DATA PIN	GPIO COMMAND BYTE								DATA BYTE 1								DATA BYTE 2							
DIN	0	0	0	0	0	0	1	0	GPIOC3	GPIOC2	GPIOC1	GPIOC0	GPIOB3	GPIOB2	GPIOB1	GPIOB0	GPIOA3	GPIOA2	GPIOA1	GPIOA0	X	X	X	X
DOUT	0	0	0	0	0	0	0	0	0	0	0	0	0	0	0	0	0	0	0	0	0	0	0	0

# 10-Bit, Multichannel ADCs/DACs with FIFO, Temperature Sensing, and GPIO Ports

MAX1020/MAX1022/MAX1057/MAX1058

## GPIO Read

Write the command byte 00000001 to indicate a GPIO read operation. The eight SCLK cycles following the command byte transfer the state of the GPIOs to DOUT in the MAX1020. The 16 SCLK cycles following the command byte transfer the state of the GPIOs to DOUT in the MAX1057/MAX1058. See Tables 18 and 19.

## DAC Serial Interface

Write a command byte 0001XXXX to the DAC select register to indicate the word to follow is written to the DAC serial interface, as detailed in Tables 1, 10, 20, and 21. Write the next 16 bits to the DAC interface register, as shown in Tables 20 and 21. Following the high-to-low transition of  $\overline{CS}$ , the data is shifted synchronously and latched into the input register on each falling edge of SCLK. Each word is 16 bits. The first 4 bits are the control bits followed by 10 data bits (MSB first) and 2 don't-care sub-bits. See Figures 9–12 for DAC timing specifications.

If  $\overline{CS}$  goes high prior to completing 16 SCLK cycles, the command is discarded. To initiate a new transfer, drive  $\overline{CS}$  low again.

For example, writing the DAC serial interface word 1111 0000 and 1111 0100 disconnects DAC outputs 4 through 7 and forces them to a high-impedance state. DAC outputs 0 through 3 remain in their previous state.

**Table 17. GPIO-Mode Control**

CONFIGURATION BIT	WRITE BIT	OUTPUT STATE	GPIO FUNCTION
1	1	1	Output
1	0	0	Output
0	1	Tri-state	Input
0	0	0	Pulldown (open drain)

**Table 18. MAX1020 GPIO Read**

DATA PIN	GPIO COMMAND BYTE								DATA BYTE							
DIN	0	0	0	0	0	0	0	1	X	X	X	X	X	X	X	X
DOUT	0	0	0	0	0	0	0	0	0	0	0	0	GPIOC1	GPIOC0	GPIOA1	GPIOA0

**Table 19. MAX1057/MAX1058 GPIO Read**

DATA PIN	GPIO COMMAND BYTE								DATA BYTE 1								DATA BYTE 2							
DIN	0	0	0	0	0	0	0	1	X	X	X	X	X	X	X	X	X	X	X	X	X	X	X	X
DOUT	0	0	0	0	0	0	0	0	0	0	0	0	GPIOC3	GPIOC2	GPIOC1	GPIOC0	GPIOB3	GPIOB2	GPIOB1	GPIOB0	GPIOA3	GPIOA2	GPIOA1	GPIOA0

# 10-Bit, Multichannel ADCs/DACs with FIFO, Temperature Sensing, and GPIO Ports

Table 20. DAC Serial-Interface Configuration

16-BIT SERIAL WORD																DESCRIPTION	FUNCTION	
MSB														LSB				
CONTROL BITS				DATA BITS														
C3	C2	C1	C0	D9	D8	D7	D6	D5	D4	D3	D2	D1	D0	X	X			
0	0	0	0	X	X	X	X	X	X	X	X	X	X	X	X	X	NOP	No operation.
0	0	0	1	0	X	X	X	X	X	X	X	X	X	X	X	X	RESET	Reset all internal registers to 000h and leave output buffers in their present state.
0	0	0	1	1	X	X	X	X	X	X	X	X	X	X	X	X	Pull-High	Preset all internal registers to FFFh and leave output buffers in their present state.
0	0	1	0	—	—	—	—	—	—	—	—	—	—	X	X	DAC0	D9–D0 to input register 0, DAC output unchanged.	
0	0	1	1	—	—	—	—	—	—	—	—	—	—	X	X	DAC1	D9–D0 to input register 1, DAC output unchanged.	
0	1	0	0	—	—	—	—	—	—	—	—	—	—	X	X	DAC2	D9–D0 to input register 2, DAC output unchanged.	
0	1	0	1	—	—	—	—	—	—	—	—	—	—	X	X	DAC3	D9–D0 to input register 3, DAC output unchanged.	
0	1	1	0	—	—	—	—	—	—	—	—	—	—	X	X	DAC4	D9–D0 to input register 4, DAC output unchanged.	
0	1	1	1	—	—	—	—	—	—	—	—	—	—	X	X	DAC5	D9–D0 to input register 5, DAC output unchanged.	
1	0	0	0	—	—	—	—	—	—	—	—	—	—	X	X	DAC6	D9–D0 to input register 6, DAC output unchanged.	
1	0	0	1	—	—	—	—	—	—	—	—	—	—	X	X	DAC7	D9–D0 to input register 7, DAC output unchanged.	
1	0	1	0	—	—	—	—	—	—	—	—	—	—	X	X	DAC0–DAC3	D9–D0 to input registers 0–3 and DAC registers 0–3. DAC outputs updated (write-through).	
1	0	1	1	—	—	—	—	—	—	—	—	—	—	X	X	DAC4–DAC7	D9–D0 to input registers 4–7 and DAC registers 5–8. DAC outputs updated (write-through).	
1	1	0	0	—	—	—	—	—	—	—	—	—	—	X	X	DAC0–DAC7	D9–D0 to input registers 0–7 and DAC Registers 0–7. DAC outputs updated (write-through).	
1	1	0	1	—	—	—	—	—	—	—	—	—	—	X	X	DAC0–DAC7	D9–D0 to input registers 0–7. DAC outputs unchanged.	
1	1	1	0	DAC7	DAC6	DAC5	DAC4	DAC3	DAC2	DAC1	DAC0	X	X	X	X	DAC0–DAC7	Input registers to DAC registers indicated by ones, DAC outputs updated, equivalent to software LDAC. (No effect on DACs indicated by zeros.)	



# 10-Bit, Multichannel ADCs/DACs with FIFO, Temperature Sensing, and GPIO Ports

**Table 21. DAC Power-Up and Power-Down Commands**

CONTROL BITS				DATA BITS										DESCRIPTION	FUNCTION		
C3	C2	C1	C0	DAC7	DAC6	DAC5	DAC4	DAC3	DAC2	DAC1	DAC0	D3	D2			D1	D0
1	1	1	1	—	—	—	—	—	—	—	—	0	0	1	X	Power-Up	Power up individual DAC buffers indicated by data in DAC0 through DAC7. A one indicates the DAC output is connected and active. A zero does not affect the DAC's present state.
1	1	1	1	—	—	—	—	—	—	—	—	0	1	0	X	Power-Down 1	Power down individual DAC buffers indicated by data in DAC0 through DAC7. A one indicates the DAC output is disconnected and high impedance. A zero does not affect the DAC's present state.
1	1	1	1	—	—	—	—	—	—	—	—	1	0	0	X	Power-Down 2	Power down individual DAC buffers indicated by data in DAC0 through DAC7. A one indicates the DAC output is disconnected and pulled to AGND with a 1kΩ resistor. A zero does not affect the DAC's present state.
1	1	1	1	—	—	—	—	—	—	—	—	0	0	0	X	Power-Down 3	Power down individual DAC buffers indicated by data in DAC0 through DAC7. A one indicates the DAC output is disconnected and pulled to AGND with a 100kΩ resistor. A zero does not affect the DAC's present state.
1	1	1	1	—	—	—	—	—	—	—	—	1	1	1	X	Power-Down 4	Power down individual DAC buffers indicated by data in DAC0 through DAC7. A one indicates the DAC output is disconnected and pulled to REF1 with a 100kΩ resistor. A zero does not affect the DAC's present state.

### Output-Data Format

Figures 6–9 illustrate the conversion timing for the MAX1020/MAX1022/MAX1057/MAX1058. All 10-bit conversion results are output in 2-byte format, MSB first, with four leading zeros and with the LSB followed by 2 sub-bits. Data appears on DOUT on the falling edges of SCLK. Data is binary for unipolar mode and two's complement for bipolar mode and temperature results. See Figures 3, 4, and 5 for input/output and temperature-transfer functions.

### ADC Transfer Functions

Figure 3 shows the unipolar transfer function for single-ended or differential inputs. Figure 4 shows the bipolar

transfer function for differential inputs. Code transitions occur halfway between successive-integer LSB values. Output coding is binary, with 1 LSB =  $V_{REF1} / 1024$  (MAX1057) and 1 LSB =  $V_{REF1} / 1024$  (MAX1020/MAX1022/MAX1058) for unipolar and bipolar operation, and 1 LSB =  $+0.125^{\circ}\text{C}$  for temperature measurements. Bipolar true-differential results and temperature-sensor results are available in two's complement format, while all others are in binary. See Tables 6, 7, and 8 for details on which setting (unipolar or bipolar) takes precedence.

In unipolar mode, AIN+ can exceed AIN- by up to  $V_{REF1}$ . In bipolar mode, either input can exceed the other by up to  $V_{REF1} / 2$ .

# 10-Bit, Multichannel ADCs/DACs with FIFO, Temperature Sensing, and GPIO Ports

## Partial Reads and Partial Writes

If the first byte of an entry in the FIFO is partially read ( $\overline{CS}$  is pulled high after fewer than eight SCLK cycles), the remaining bits are lost for that byte. The next byte of data that is read out contains the next 8 bits. If the first byte of an entry in the FIFO is read out fully, but the second byte is read out partially, the rest of that byte is lost. The remaining data in the FIFO is unaffected and can be read out normally after taking  $\overline{CS}$  low again, as long as the 4 leading bits (normally zeros) are ignored. If  $\overline{CS}$  is pulled low before  $\overline{EOC}$  goes low, a conversion may not be completed and the FIFO data may not be correct. Incorrect writes (pulling  $\overline{CS}$  high before completing eight SCLK cycles) are ignored and the register remains unchanged.

## Applications Information

### Internally Timed Acquisitions and Conversions Using $\overline{CNVST}$

#### ADC Conversions in Clock Mode 00

In clock mode 00, the wake-up, acquisition, conversion, and shutdown sequence is initiated through  $\overline{CNVST}$  and performed automatically using the internal oscillator. Results are added to the internal FIFO to be read out later. See Figure 6 for clock mode 00 timing after a command byte is issued. See Table 5 for details on programming the clock mode in the setup register.

Initiate a scan by setting  $\overline{CNVST}$  low for at least 40ns before pulling it high again. The MAX1020/MAX1022/

MAX1057/MAX1058 then wake up, scan all requested channels, store the results in the FIFO, and shut down. After the scan is complete,  $\overline{EOC}$  is pulled low and the results are available in the FIFO. Wait until  $\overline{EOC}$  goes low before pulling  $\overline{CS}$  low to communicate with the serial interface.  $\overline{EOC}$  stays low until  $\overline{CS}$  or  $\overline{CNVST}$  is pulled low again. A temperature-conversion result, if requested, precedes all other FIFO results. Temperature results are available in 12-bit format.

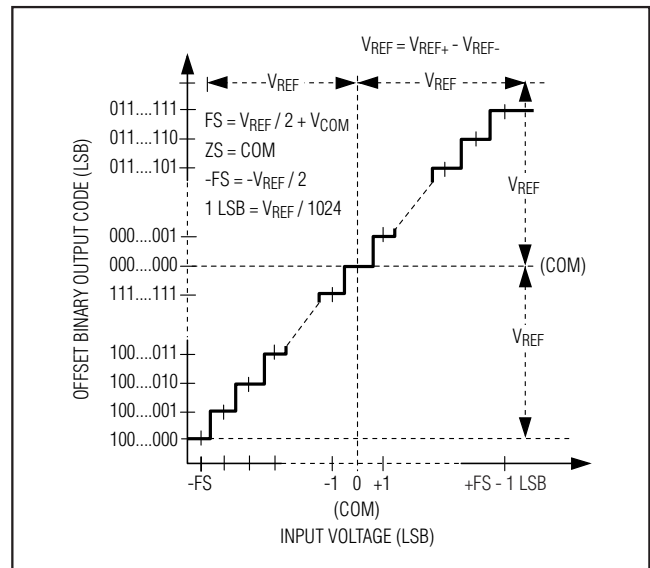

Figure 4. Bipolar Transfer Function—Full Scale ( $\pm FS$ ) =  $\pm V_{REF} / 2$

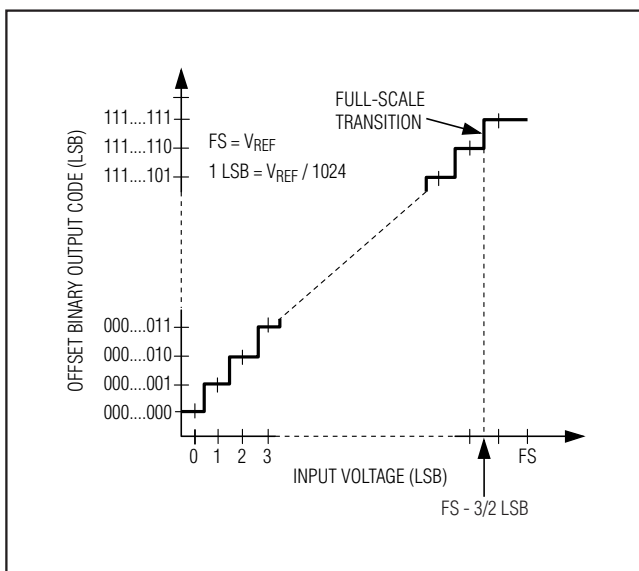

Figure 3. Unipolar Transfer Function—Full Scale (FS) =  $V_{REF}$

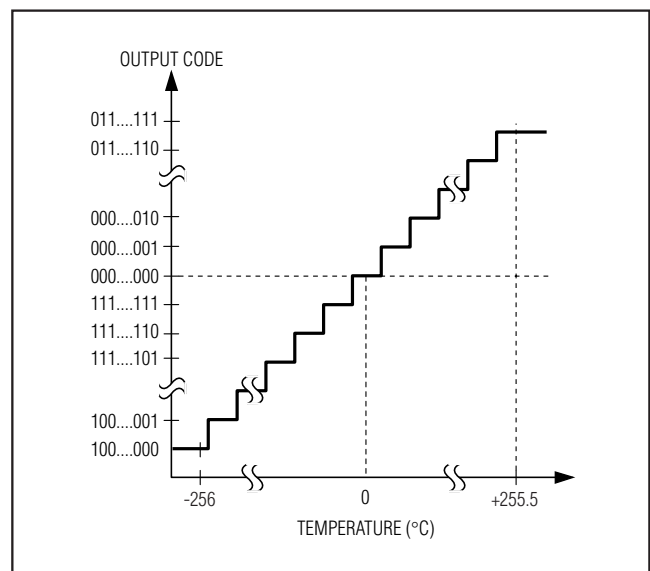

Figure 5. Temperature Transfer Function

# 10-Bit, Multichannel ADCs/DACs with FIFO, Temperature Sensing, and GPIO Ports

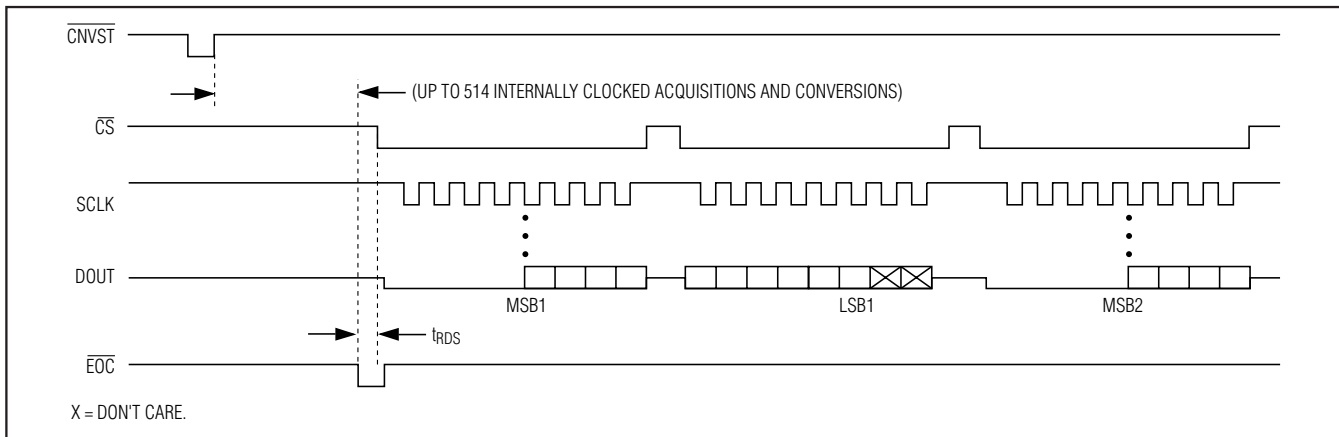

Figure 6. Clock Mode 00—After writing a command byte, set  $\overline{\text{CNVST}}$  low for at least 40ns to begin a conversion.

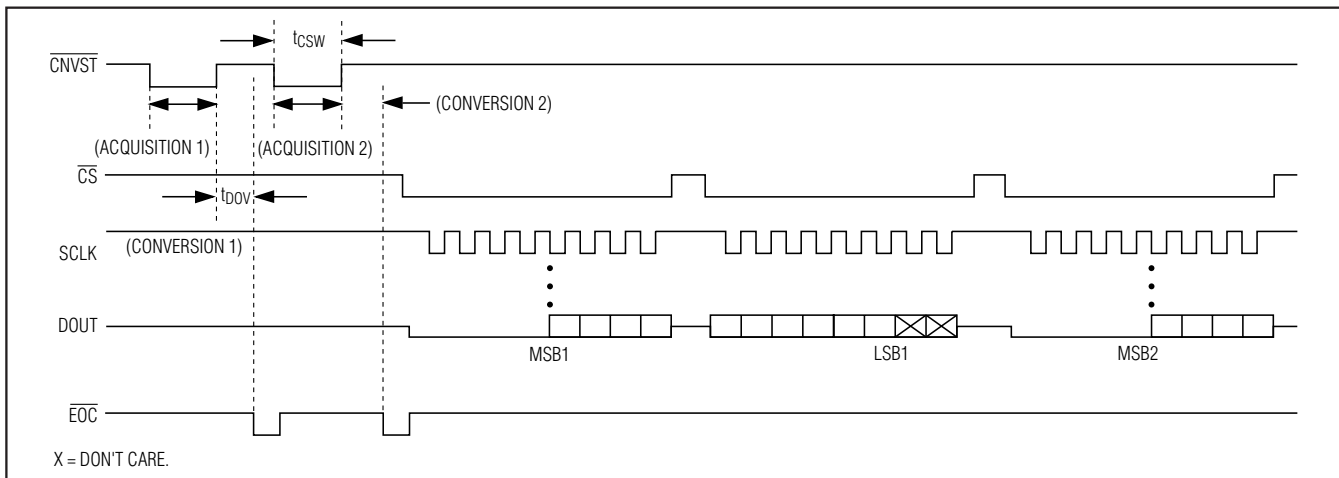

Figure 7. Clock Mode 01—After writing a command byte, request multiple conversions by setting  $\overline{\text{CNVST}}$  low for each conversion.

Do not issue a second  $\overline{\text{CNVST}}$  signal before  $\overline{\text{EOC}}$  goes low; otherwise, the FIFO can be corrupted. Wait until all conversions are complete before reading the FIFO. SPI communications to the DAC and GPIO registers are permitted during conversion. However, coupled noise may result in degraded ADC signal-to-noise ratio (SNR).

## Externally Timed Acquisitions and Internally Timed Conversions with $\overline{\text{CNVST}}$

### ADC Conversions in Clock Mode 01

In clock mode 01, conversions are requested one at a time using  $\overline{\text{CNVST}}$  and performed automatically using the internal oscillator. See Figure 7 for clock mode 01 timing after a command byte is issued.

Setting  $\overline{\text{CNVST}}$  low begins an acquisition, wakes up the ADC, and places it in track mode. Hold  $\overline{\text{CNVST}}$  low for

at least 1.4 $\mu\text{s}$  to complete the acquisition. If reference mode 00 or 10 is selected, an additional 45 $\mu\text{s}$  is required for the internal reference to power up. If a temperature measurement is being requested, reference power-up and temperature measurement is internally timed. In this case, hold  $\overline{\text{CNVST}}$  low for at least 40 $\mu\text{s}$ .

Set  $\overline{\text{CNVST}}$  high to begin a conversion. Sampling is completed approximately 500ns after  $\overline{\text{CNVST}}$  goes high. After the conversion is complete, the ADC shuts down and pulls  $\overline{\text{EOC}}$  low.  $\overline{\text{EOC}}$  stays low until  $\overline{\text{CS}}$  or  $\overline{\text{CNVST}}$  is pulled low again. Wait until  $\overline{\text{EOC}}$  goes low before pulling  $\overline{\text{CS}}$  or  $\overline{\text{CNVST}}$  low. The number of  $\overline{\text{CNVST}}$  signals must equal the number of conversions requested by the scan and averaging registers to correctly update the FIFO. Wait until all conversions are complete before reading the FIFO. SPI communications to the DAC and GPIO registers are permitted during con-

# 10-Bit, Multichannel ADCs/DACs with FIFO, Temperature Sensing, and GPIO Ports

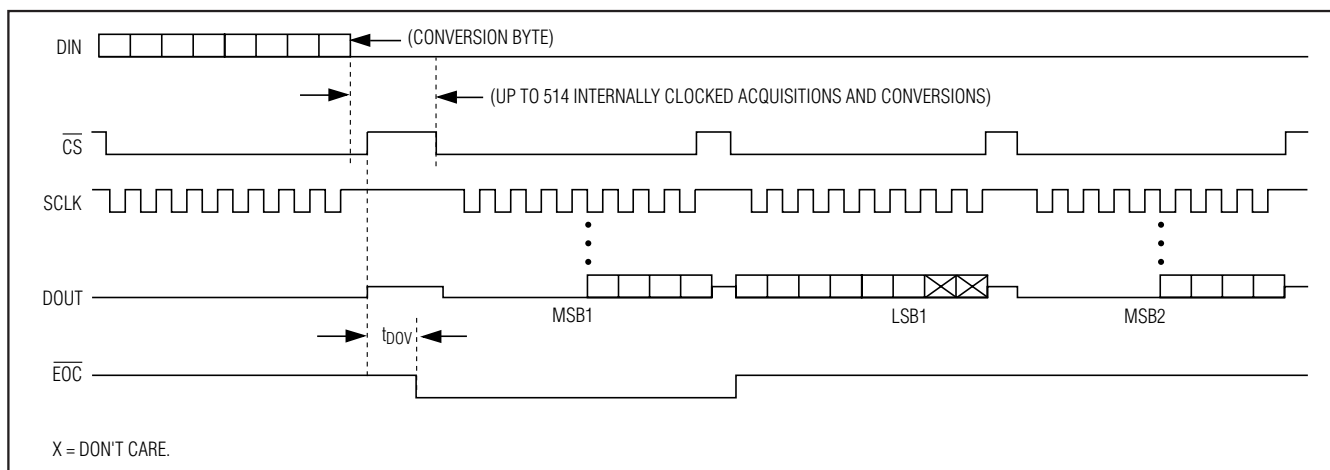

Figure 8. Clock Mode 10—The command byte to the conversion register begins the acquisition ( $\overline{CNVST}$  is not required).

version. However, coupled noise may result in degraded ADC SNR.

If averaging is turned on, multiple  $\overline{CNVST}$  pulses need to be performed before a result is written to the FIFO. Once the proper number of conversions has been performed to generate an averaged FIFO result (as specified to the averaging register), the scan logic automatically switches the analog-input multiplexer to the next requested channel. If a temperature measurement is programmed, it is performed after the first rising edge of  $\overline{CNVST}$  following the command byte written to the conversion register. The temperature-conversion result is available on DOUT once  $\overline{EOC}$  has been pulled low. Temperature results are available in 12-bit format.

## Internally Timed Acquisitions and Conversions Using the Serial Interface

### ADC Conversions in Clock Mode 10

In clock mode 10, the wake-up, acquisition, conversion, and shutdown sequence is initiated by writing a command byte to the conversion register, and is performed automatically using the internal oscillator. This is the default clock mode upon power-up. See Figure 8 for clock mode 10 timing.

Initiate a scan by writing a command byte to the conversion register. The MAX1020/MAX1022/MAX1057/MAX1058 then power up, scan all requested channels, store the results in the FIFO, and shut down. After the scan is complete,  $\overline{EOC}$  is pulled low and the results are available in the FIFO. If a temperature measurement is requested, the temperature result precedes all other FIFO results. Temperature results are available in 12-bit format.  $\overline{EOC}$  stays low until  $\overline{CS}$  is pulled low again. Wait until all conversions are complete before reading the FIFO. SPI communications to the DAC and GPIO registers are permitted during conversion. However, coupled noise may result in degraded ADC SNR.

# 10-Bit, Multichannel ADCs/DACs with FIFO, Temperature Sensing, and GPIO Ports

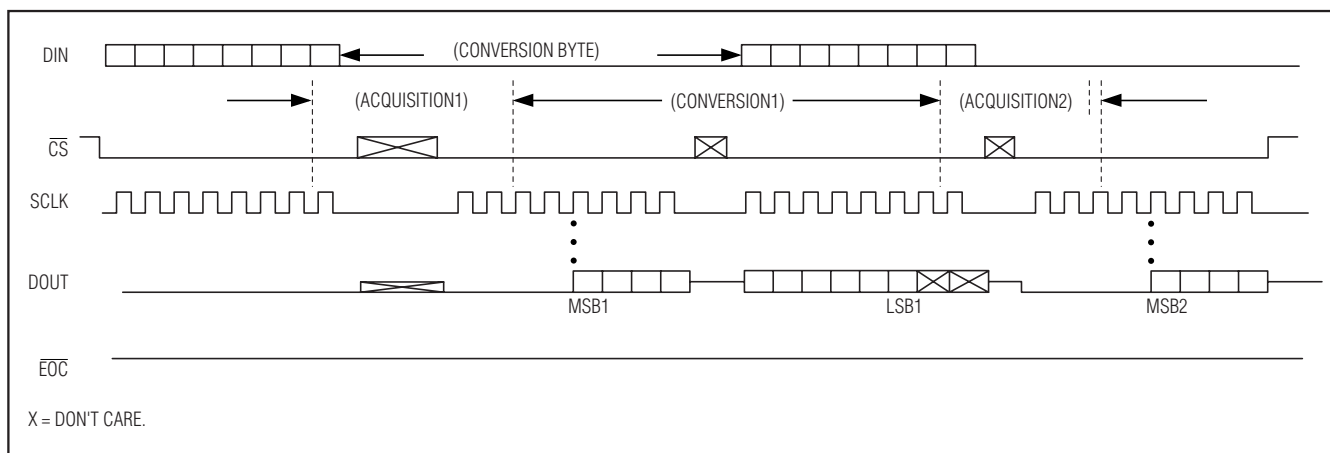

Figure 9. Clock Mode 11—Externally Timed Acquisition, Sampling, and Conversion without  $\overline{CNVST}$

## Externally Clocked Acquisitions and Conversions Using the Serial Interface

### ADC Conversions in Clock Mode 11

In clock mode 11, acquisitions and conversions are initiated by writing a command byte to the conversion register and are performed one at a time using the SCLK as the conversion clock. Scanning, averaging and the FIFO are disabled, and the conversion result is available at DOUT during the conversion. Output data is updated on the rising edge of SCLK in clock mode 11. See Figure 9 for clock mode 11 timing.

Initiate a conversion by writing a command byte to the conversion register followed by 16 SCLK cycles. If  $\overline{CS}$  is pulsed high between the eighth and ninth cycles, the pulse width must be less than 100 $\mu$ s. To continuously convert at 16 cycles per conversion, alternate 1 byte of zeros (NOP byte) between each conversion byte. If 2 NOP bytes follow a conversion byte, the analog cells power down at the end of the second NOP. Set the FBGON bit to one in the reset register to keep the internal bias block powered.

If reference mode 00 is requested, or if an external reference is selected but a temperature measurement is being requested, wait 45 $\mu$ s with  $\overline{CS}$  high after writing the conversion byte to extend the acquisition and allow the internal reference to power up. To perform a temperature measurement, write 24 bytes (192 cycles) of zeros after the conversion byte. The temperature result appears on DOUT during the last 2 bytes of the 192 cycles. Temperature results are available in 12-bit format.

### Conversion-Time Calculations

The conversion time for each scan is based on a number of different factors: conversion time per sample, samples per result, results per scan, if a temperature measurement is requested, and if the external reference is in use. Use the following formula to calculate the total conversion time for an internally timed conversion in clock mode 00 and 10 (see the *Electrical Characteristics*, as applicable):

$$\text{Total conversion time} = t_{\text{CNV}} \times n_{\text{AVG}} \times n_{\text{SCAN}} + t_{\text{TS}} + t_{\text{INT-REF,SU}}$$

where:

$t_{\text{CNV}}$  =  $t_{\text{DOV}}$ , where  $t_{\text{DOV}}$  is dependent on clock mode and reference mode selected

$n_{\text{AVG}}$  = samples per result (amount of averaging)

$n_{\text{SCAN}}$  = number of times each channel is scanned; set to one unless [SCAN1, SCAN0] = 10

$t_{\text{TS}}$  = time required for temperature measurement (53.1 $\mu$ s); set to zero if temperature measurement is not requested

$t_{\text{INT-REF,SU}}$  =  $t_{\text{WU}}$  (external-reference wake-up); if a conversion using the external reference is requested

In clock mode 01, the total conversion time depends on how long  $\overline{CNVST}$  is held low or high. Conversion time in externally clocked mode (CKSEL1, CKSEL0 = 11) depends on the SCLK period and how long  $\overline{CS}$  is held high between each set of eight SCLK cycles. In clock mode 01, the total conversion time does not include the time required to turn on the internal reference.

# 10-Bit, Multichannel ADCs/DACs with FIFO, Temperature Sensing, and GPIO Ports

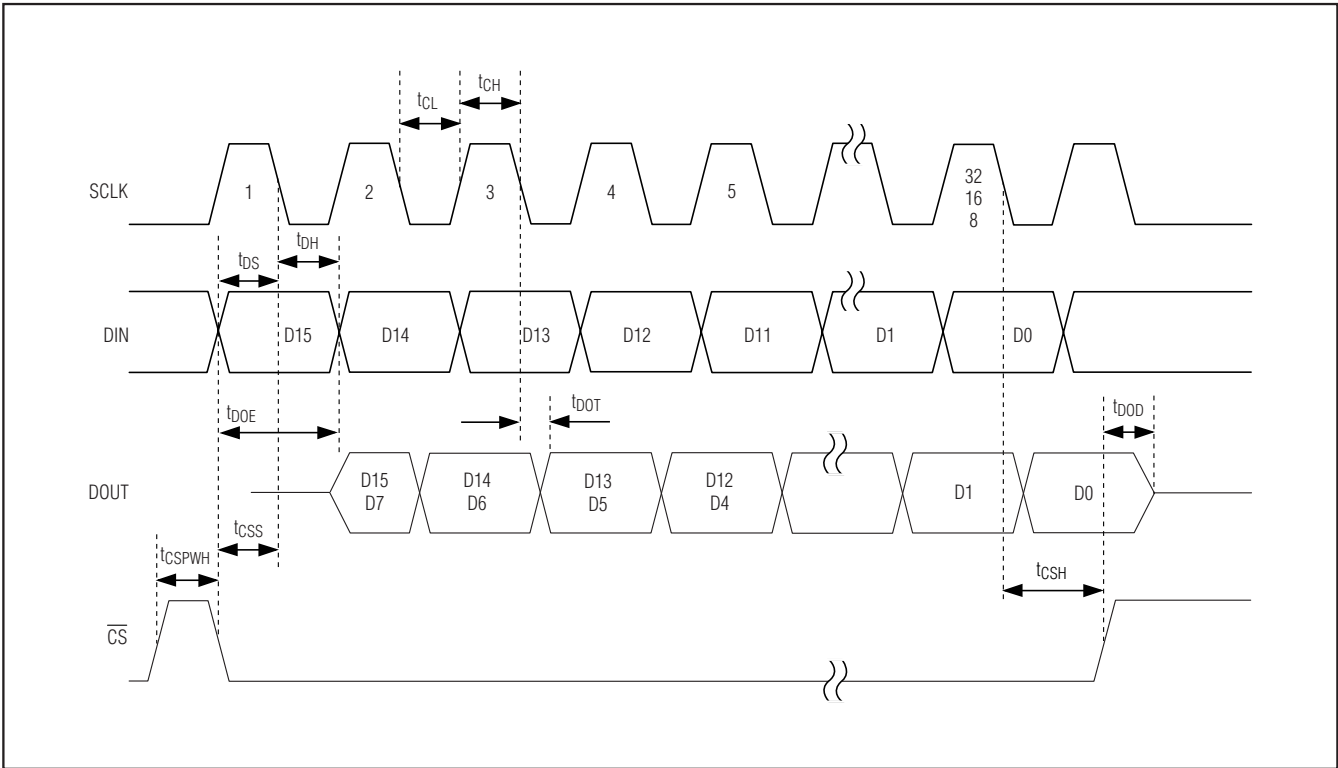

Figure 10. DAC/GPIO Serial-Interface Timing (Clock Modes 00, 01, and 10)

### DAC/GPIO Timing

Figures 10–13 detail the timing diagrams for writing to the DAC and GPIOs. Figure 10 shows the timing specifications for clock modes 00, 01, and 10. Figure 11 shows the timing specifications for clock mode 11. Figure 12 details the timing specifications for the DAC input select register and 2 bytes to follow. Output data

is updated on the rising edge of SCLK in clock mode 11. Figure 13 shows the GPIO timing. Figure 14 shows the timing details of a hardware LDAC command DAC-register update. For a software-command DAC-register update,  $t_S$  is valid from the rising edge of  $\overline{CS}$ , which follows the last data bit in the software command word.

# 10-Bit, Multichannel ADCs/DACs with FIFO, Temperature Sensing, and GPIO Ports

MAX1020/MAX1022/MAX1057/MAX1058

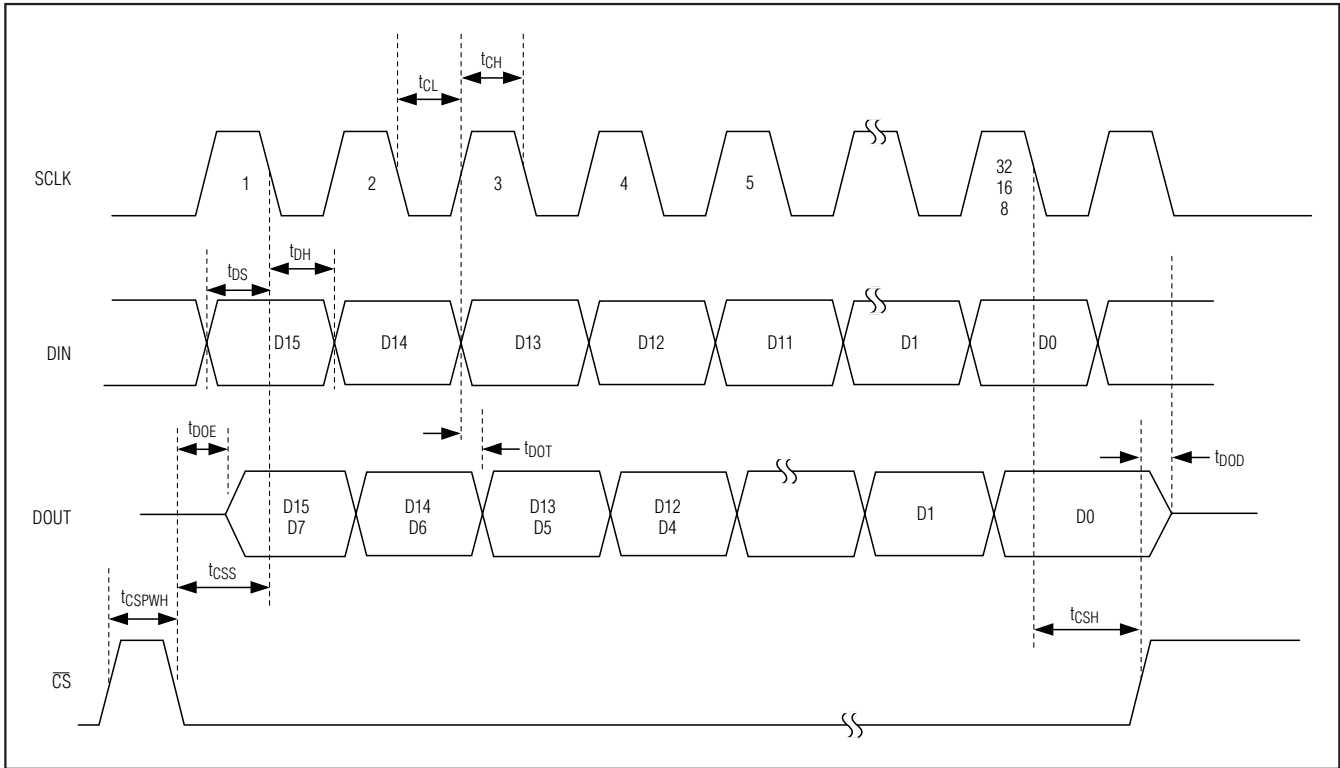

Figure 11. DAC/GPIO Serial-Interface Timing (Clock Mode 11)

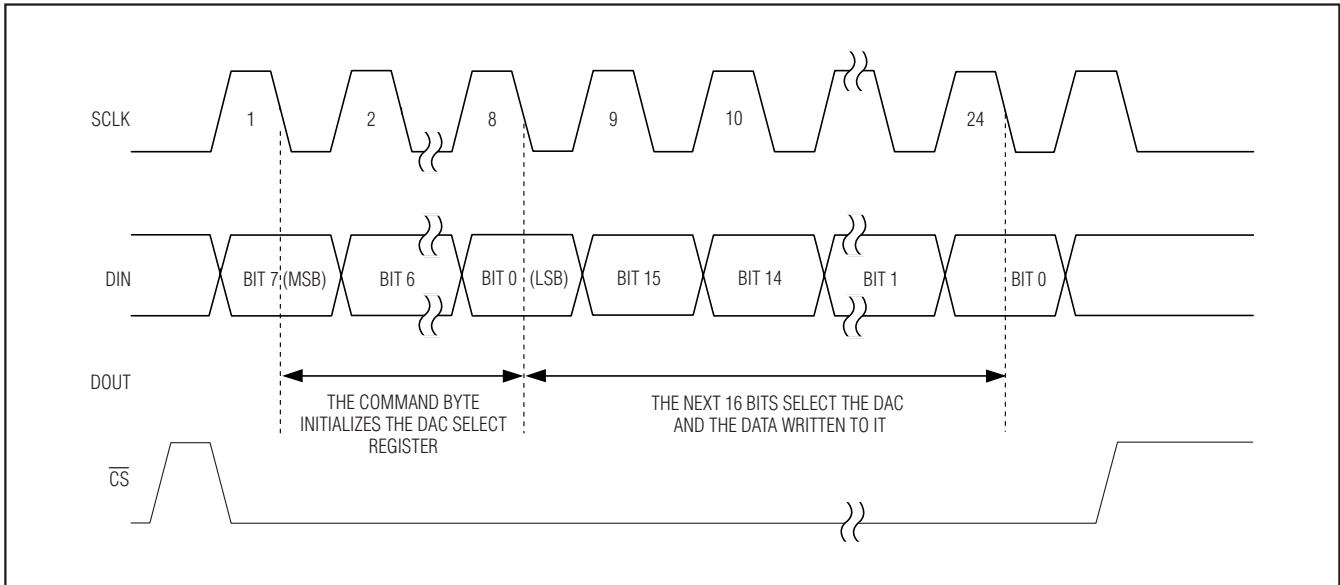

Figure 12. DAC-Select Register Byte and DAC Serial-Interface Word

# 10-Bit, Multichannel ADCs/DACs with FIFO, Temperature Sensing, and GPIO Ports

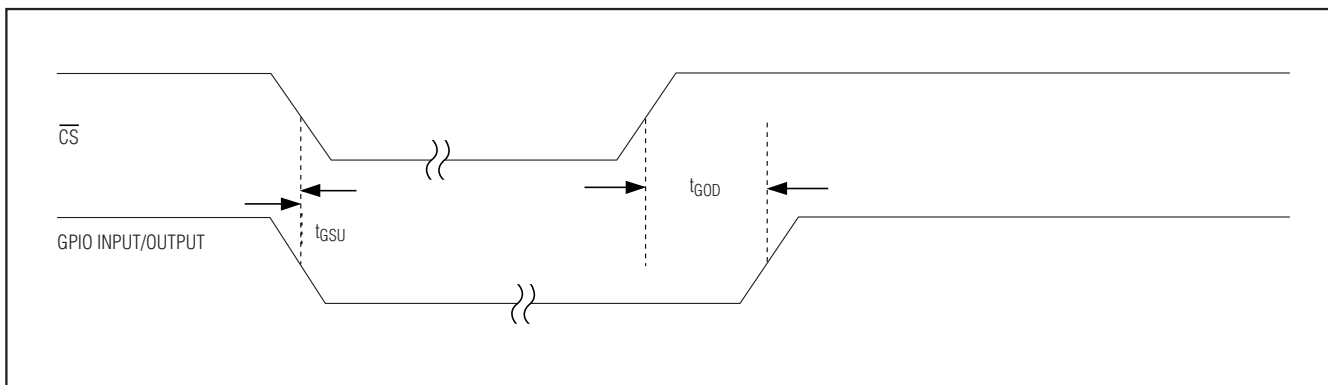

Figure 13. GPIO Timing

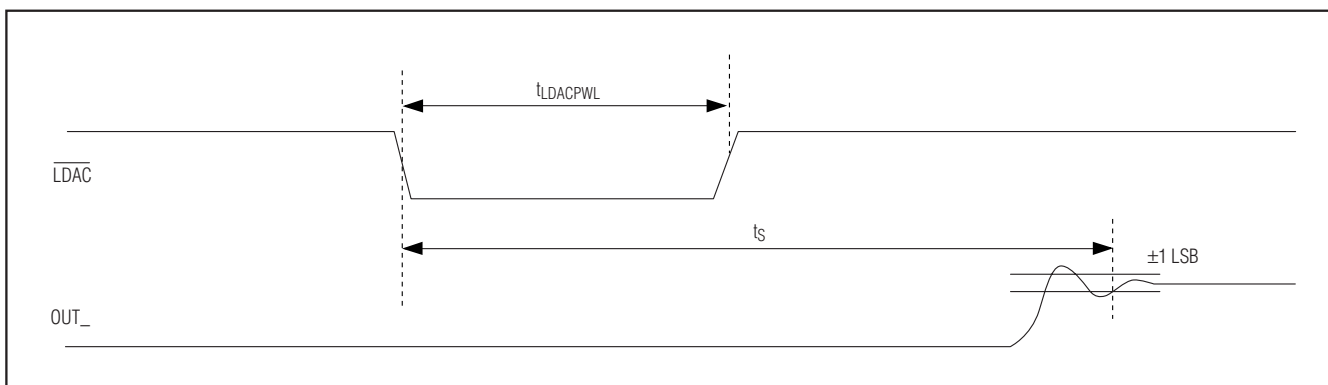

Figure 14.  $\overline{\text{LDAC}}$  Functionality

## $\overline{\text{LDAC}}$ Functionality

Drive  $\overline{\text{LDAC}}$  low to transfer the content of the input registers to the DAC registers. Drive  $\overline{\text{LDAC}}$  permanently low to make the DAC register transparent. The DAC output typically settles from zero to full scale within  $\pm 1$  LSB after  $2\mu\text{s}$ . See Figure 14.

## Layout, Grounding, and Bypassing

For best performance, use PC boards. Ensure that digital and analog signal lines are separated from each other. Do not run analog and digital signals parallel to one another (especially clock signals) or do not run digital lines underneath the MAX1020/MAX1022/MAX1057/MAX1058 package. High-frequency noise in the AVDD power supply may affect performance. Bypass the AVDD supply with a  $0.1\mu\text{F}$  capacitor to AGND, close to the AVDD pin. Bypass the DVDD supply with a  $0.1\mu\text{F}$  capacitor to DGND, close to the DVDD pin. Minimize capacitor lead lengths for best supply-noise rejection. If the power supply is very noisy, connect a  $10\Omega$  resistor in series with the supply to improve power-supply filtering.

The MAX1020/MAX1022/MAX1057/MAX1058 TQFN packages contain an exposed pad on the underside of the device. Connect this exposed pad to AGND. Refer to the MAX1258EVKIT for an example of proper layout.

## Definitions

### Integral Nonlinearity

Integral nonlinearity (INL) is the deviation of the values on an actual transfer function from a straight line. This straight line can be either a best-straight-line fit or a line drawn between the end points of the transfer function, once offset and gain errors have been nullified. INL for the MAX1020/MAX1022/MAX1057/MAX1058 is measured using the end-point method.

### Differential Nonlinearity

Differential nonlinearity (DNL) is the difference between an actual step width and the ideal value of 1 LSB. A DNL error specification of less than 1 LSB guarantees no missing codes and a monotonic transfer function.



# 10-Bit, Multichannel ADCs/DACs with FIFO, Temperature Sensing, and GPIO Ports

## Unipolar ADC Offset Error

For an ideal converter, the first transition occurs at 0.5 LSB, above zero. Offset error is the amount of deviation between the measured first transition point and the ideal first transition point.

## Bipolar ADC Offset Error

While in bipolar mode, the ADC's ideal midscale transition occurs at AGND -0.5 LSB. Bipolar offset error is the measured deviation from this ideal value.

## ADC Gain Error

Gain error is defined as the amount of deviation between the ideal transfer function and the measured transfer function, with the offset error removed and with a full-scale analog input voltage applied to the ADC, resulting in all ones at DOUT.

## DAC Offset Error

DAC offset error is determined by loading a code of all zeros into the DAC and measuring the analog output voltage.

## DAC Gain Error

DAC gain error is defined as the amount of deviation between the ideal transfer function and the measured transfer function, with the offset error removed, when loading a code of all ones into the DAC.

## Aperture Jitter

Aperture jitter ( $t_{AJ}$ ) is the sample-to-sample variation in the time between the samples.

## Aperture Delay

Aperture delay ( $t_{AD}$ ) is the time between the rising edge of the sampling clock and the instant when an actual sample is taken.

## Signal-to-Noise Ratio

For a waveform perfectly reconstructed from digital samples, signal-to-noise ratio (SNR) is the ratio of full-scale analog input (RMS value) to the RMS quantization error (residual error). The ideal, theoretical minimum analog-to-digital noise is caused by quantization error only and results directly from the ADC's resolution (N bits):

$$\text{SNR} = (6.02 \times N + 1.76)\text{dB}$$

In reality, there are other noise sources besides quantization noise, including thermal noise, reference noise, clock jitter, etc. Therefore, SNR is calculated by taking the ratio of the RMS signal to the RMS noise. RMS noise includes all spectral components to the Nyquist frequency excluding the fundamental, the first five harmonics, and the DC offset.

## Signal-to-Noise Plus Distortion

Signal-to-noise plus distortion (SINAD) is the ratio of the fundamental input frequency's RMS amplitude to the RMS equivalent of all other ADC output signals:

$$\text{SINAD}(\text{dB}) = 20 \times \log(\text{Signal}_{\text{RMS}} / \text{Noise}_{\text{RMS}})$$

## Effective Number of Bits

Effective number of bits (ENOB) indicates the global accuracy of an ADC at a specific input frequency and sampling rate. An ideal ADC's error consists of quantization noise only. With an input range equal to the full-scale range of the ADC, calculate the ENOB as follows:

$$\text{ENOB} = (\text{SINAD} - 1.76) / 6.02$$

## Total Harmonic Distortion

Total harmonic distortion (THD) is the ratio of the RMS sum of the first five harmonics of the input signal to the fundamental itself. This is expressed as:

$$\text{THD} = 20 \times \log \left[ \frac{\sqrt{(V_2^2 + V_3^2 + V_4^2 + V_5^2 + V_6^2)}}{V_1} \right]$$

where  $V_1$  is the fundamental amplitude, and  $V_2$  through  $V_6$  are the amplitudes of the first five harmonics.

## Spurious-Free Dynamic Range

Spurious-free dynamic range (SFDR) is the ratio of RMS amplitude of the fundamental (maximum signal component) to the RMS value of the next largest distortion component.

## ADC Channel-to-Channel Crosstalk

Bias the ON channel to midscale. Apply a full-scale sine wave test tone to all OFF channels. Perform an FFT on the ON channel. ADC channel-to-channel crosstalk is expressed in dB as the amplitude of the FFT spur at the frequency associated with the OFF channel test tone.

## Intermodulation Distortion (IMD)

IMD is the total power of the intermodulation products relative to the total input power when two tones,  $f_1$  and  $f_2$ , are present at the inputs. The intermodulation products are  $(f_1 \pm f_2)$ ,  $(2 \times f_1)$ ,  $(2 \times f_2)$ ,  $(2 \times f_1 \pm f_2)$ ,  $(2 \times f_2 \pm f_1)$ . The individual input tone levels are at -7dBFS.

## Small-Signal Bandwidth

A small -20dBFS analog input signal is applied to an ADC so the signal's slew rate does not limit the ADC's performance. The input frequency is then swept up to the point where the amplitude of the digitized conversion result has decreased by -3dB. Note that the T/H performance is usually the limiting factor for the small-signal input bandwidth.

# 10-Bit, Multichannel ADCs/DACs with FIFO, Temperature Sensing, and GPIO Ports

## Full-Power Bandwidth

A large -0.5dBFS analog input signal is applied to an ADC, and the input frequency is swept up to the point where the amplitude of the digitized conversion result has decreased by -3dB. This point is defined as full-power input bandwidth frequency.

## DAC Digital Feedthrough

DAC digital feedthrough is the amount of noise that appears on the DAC output when the DAC digital control lines are toggled.

## ADC Power-Supply Rejection

ADC power-supply rejection (PSR) is defined as the shift in offset error when the power-supply is moved from the minimum operating voltage to the maximum operating voltage.

## DAC Power-Supply Rejection

DAC PSR is the amount of change in the converter's value at full-scale as the power-supply voltage changes from its nominal value. PSR assumes the converter's linearity is unaffected by changes in the power-supply voltage.

## Chip Information

PROCESS: BiCMOS

## Package Information

For the latest package outline information and land patterns (footprints), go to [www.maxim-ic.com/packages](http://www.maxim-ic.com/packages). Note that a "+", "#", or "-" in the package code indicates RoHS status only. Package drawings may show a different suffix character, but the drawing pertains to the package regardless of RoHS status.

PACKAGE TYPE	PACKAGE CODE	OUTLINE NO.	LAND PATTERN NO.
36 TQFN-EP	T3666+3	<a href="#">21-0141</a>	<a href="#">90-0050</a>
48 TQFN-EP	T4877+6	<a href="#">21-0144</a>	<a href="#">90-0132</a>

# 10-Bit, Multichannel ADCs/DACs with FIFO, Temperature Sensing, and GPIO Ports

## Pin Configurations

MAX1020/MAX1022/MAX1057/MAX1058

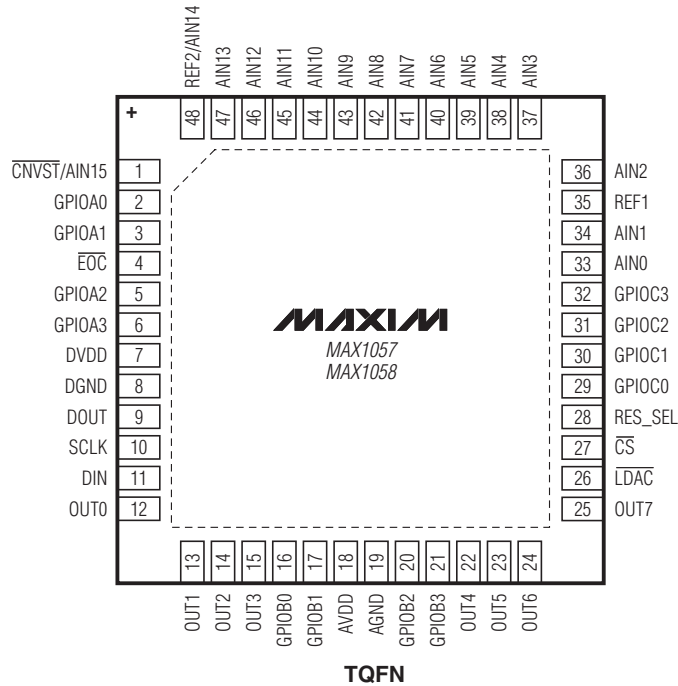
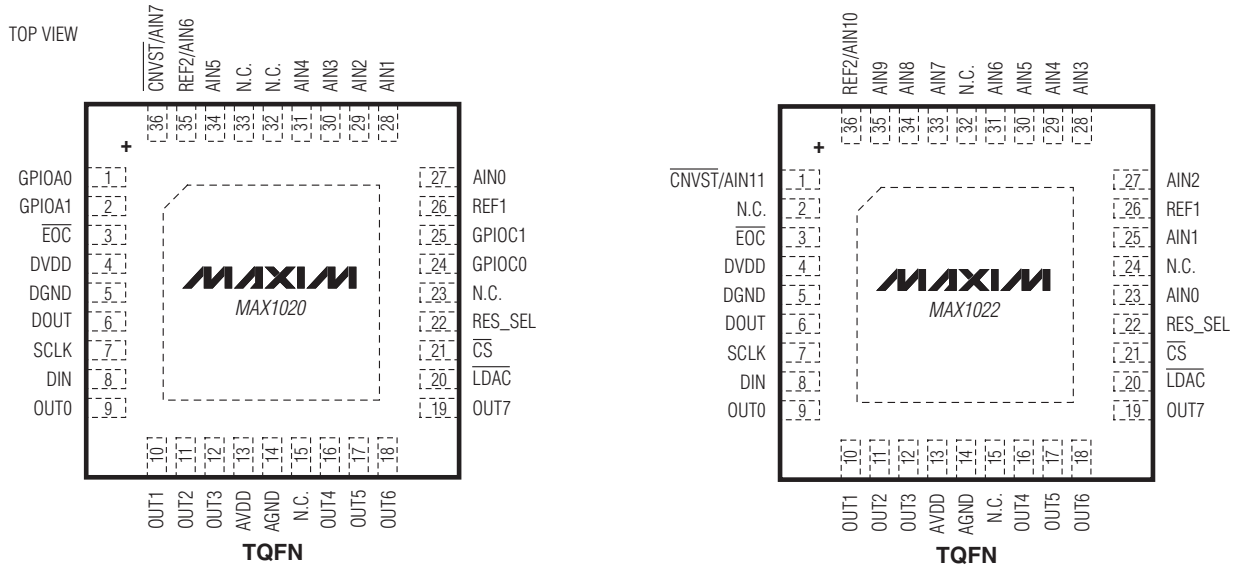

# 10-Bit, Multichannel ADCs/DACs with FIFO, Temperature Sensing, and GPIO Ports

## Revision History

REVISION NUMBER	REVISION DATE	DESCRIPTION	PAGES CHANGED
0	5/04	Initial release	—
4	3/08	Changed timing characteristic specification	7
5	2/12	Removed A and B grade, updated style.	1–8, 16, 19, 21, 22, 40, 42, 43

Maxim cannot assume responsibility for use of any circuitry other than circuitry entirely embodied in a Maxim product. No circuit patent licenses are implied. Maxim reserves the right to change the circuitry and specifications without notice at any time. The parametric values (min and max limits) shown in the Electrical Characteristics table are guaranteed. Other parametric values quoted in this data sheet are provided for guidance.

44 \_\_\_\_\_ **Maxim Integrated Products, 120 San Gabriel Drive, Sunnyvale, CA 94086 408-737-7600**

## Данный компонент на территории Российской Федерации

### Вы можете приобрести в компании MosChip.

Для оперативного оформления запроса Вам необходимо перейти по данной ссылке:

<http://moschip.ru/get-element>

Вы можете разместить у нас заказ для любого Вашего проекта, будь то серийное производство или разработка единичного прибора.

В нашем ассортименте представлены ведущие мировые производители активных и пассивных электронных компонентов.

Нашей специализацией является поставка электронной компонентной базы двойного назначения, продукции таких производителей как XILINX, Intel (ex.ALTERA), Vicor, Microchip, Texas Instruments, Analog Devices, Mini-Circuits, Amphenol, Glenair.

Сотрудничество с глобальными дистрибьюторами электронных компонентов, предоставляет возможность заказывать и получать с международных складов практически любой перечень компонентов в оптимальные для Вас сроки.

На всех этапах разработки и производства наши партнеры могут получить квалифицированную поддержку опытных инженеров.

Система менеджмента качества компании отвечает требованиям в соответствии с ГОСТ Р ИСО 9001, ГОСТ РВ 0015-002 и ЭС РД 009

### Офис по работе с юридическими лицами:

105318, г.Москва, ул.Щербаковская д.3, офис 1107, 1118, ДЦ «Щербаковский»

Телефон: +7 495 668-12-70 (многоканальный)

Факс: +7 495 668-12-70 (доб.304)

E-mail: [info@moschip.ru](mailto:info@moschip.ru)

Skype отдела продаж:

moschip.ru

moschip.ru\_4

moschip.ru\_6

moschip.ru\_9