

R Series Attachment

BASE Attachment

Plate model	Applicable models
F-R10-1	R10A
F-R15-1	R15A
F-R25-1	R25A
F-R50-1	R50A
F-R100-1	R100
F-R150-1	R150

Example
(R100)

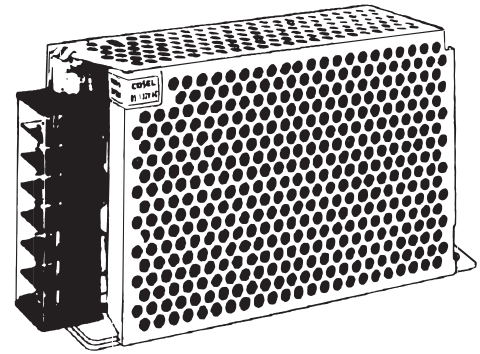

< TOP VIEW > (Unit : mm) (Tolerance : ±1)

<p>F-R10-1</p> <p>Size</p> <ul style="list-style-type: none"> * Material : SPCC * Thickness : 2.0 * Weight : 40g max 	<p>F-R15-1</p> <p>Size</p> <ul style="list-style-type: none"> * Material : SPCC * Thickness : 2.0 * Weight : 50g max
<p>* M3 Flat screw is requested when mounting. Please check the instruction manual for the size of screw.</p>	
<p>Mounting hole size</p> <p>FRONT←</p>	<p>Mounting hole size</p> <p>FRONT←</p>
<p>F-R25-1</p> <p>Size</p> <ul style="list-style-type: none"> * Material : SPCC * Thickness : 2.0 * Weight : 65g max 	<p>F-R50-1</p> <p>Size</p> <ul style="list-style-type: none"> * Material : SPCC * Thickness : 2.0 * Weight : 80g max
<p>* M3 Flat screw is requested when mounting. Please check the instruction manual for the size of screw.</p>	
<p>Mounting hole size</p> <p>FRONT←</p>	<p>Mounting hole size</p> <p>FRONT←</p>
<p>F-R100-1</p> <p>Size</p> <ul style="list-style-type: none"> * Material : SPCC * Thickness : 2.0 * Weight : 110g max 	<p>F-R150-1</p> <p>Size</p> <ul style="list-style-type: none"> * Material : SPCC * Thickness : 2.0 * Weight : 150g max
<p>* M4 Flat screw is requested when mounting. Please check the instruction manual for the size of screw.</p>	
<p>Mounting hole size</p> <p>FRONT←</p>	<p>Mounting hole size</p> <p>FRONT←</p>

FRONT · REVERSE
Attachment

Plate model	Applicable models
F-K10-2	R10A
F-R15-2	R15A
F-R25-2	R25A
F-R50-2	R50A
F-R100-2	R100
F-R150-2	R150

Example

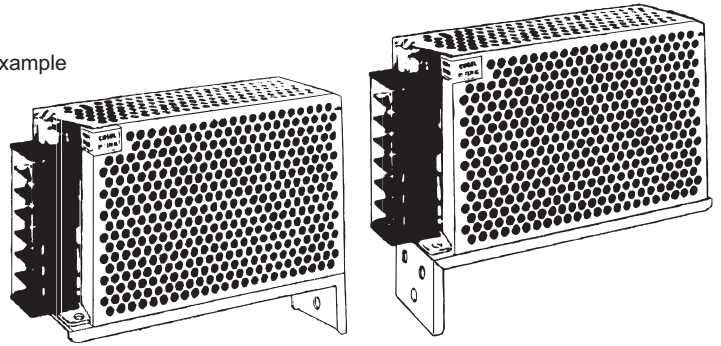

< TOP VIEW > (Unit : mm) (Tolerance : ±1)

<p style="text-align: center;">F-K10-2</p> <p>Size</p> <ul style="list-style-type: none"> ★ Material : SPCC ★ Thickness : 1.6 ★ Weight : 60g max 	<p style="text-align: center;">F-R15-2</p> <p>Size</p> <ul style="list-style-type: none"> ★ Material : SPCC ★ Thickness : 1.6 ★ Weight : 75g max
--	--

★ M3 screw is requested when mounting.
Please check the instruction manual for the size of screw.

<p style="text-align: center;">F-R25-2</p> <p>Size</p> <ul style="list-style-type: none"> ★ Material : SPCC ★ Thickness : 1.6 ★ Weight : 85g max 	<p style="text-align: center;">F-R50-2</p> <p>Size</p> <ul style="list-style-type: none"> ★ Material : SPCC ★ Thickness : 1.6 ★ Weight : 100g max
--	---

★ M3 screw is requested when mounting.
Please check the instruction manual for the size of screw.

<p style="text-align: center;">F-R100-2</p> <p>Size</p> <ul style="list-style-type: none"> ★ Material : SPCC ★ Thickness : 1.6 ★ Weight : 130g max 	<p style="text-align: center;">F-R150-2</p> <p>Size</p> <ul style="list-style-type: none"> ★ Material : SPCC ★ Thickness : 2.0 ★ Weight : 220g max
--	--

★ M4 screw is requested when mounting.
Please check the instruction manual for the size of screw.

Din rail Attachment Plate

APPLICABLE TO MODEL

Din rail width : 35mm

Plate model	Model	screws for installation	
		Type	Qty
FD-A	R50A RMB30A, RMC30A	M3	2pcs
FD-B	MMC8A R10A, R15A, R25A RMB15A, RMC15A	M3	2pcs

EXTERNAL VIEW

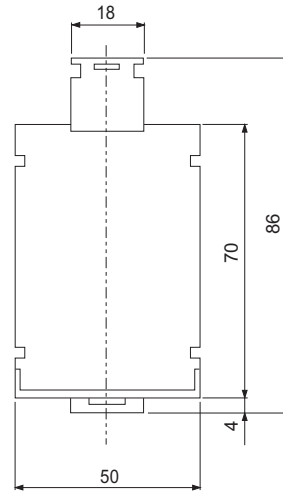
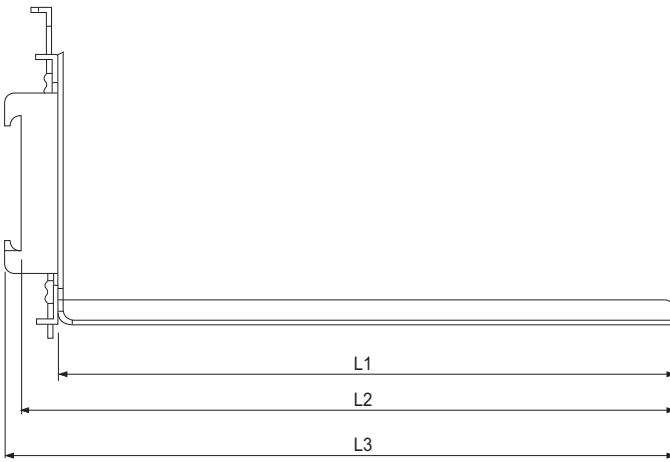

(Unit : mm)

Model	L1	L2	L3
FD-A	165	174.5	178.6
FD-B	115	124.5	128.6

- * Material : SPCC
- * Thickness : 1.6
- * Tolerance : ±1
- * Weight : FD-A 290g max
FD-B 240g max

DIN RAIL ATTACHMENT MODEL : FD-SP

MOUNTING EXAMPLE

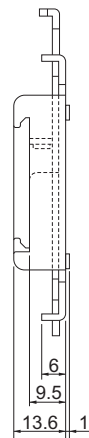
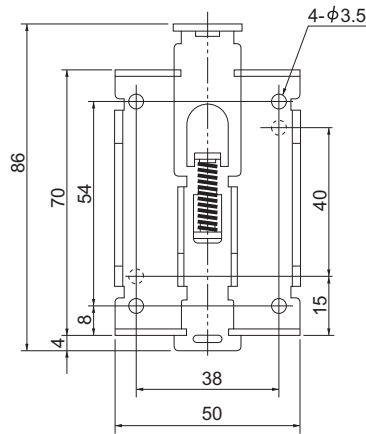
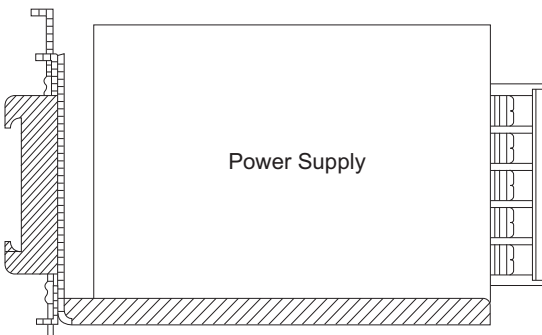

- * Material : SPCC
- * Thickness : 1.6
- * Tolerance : ±1
- * Weight : 85g max

Harness for input/output(J type) is prepared in R series.

R Series
RMB Series
RMC Series

Mating harness

Model	Harness model #	
	Input	Output
R10A · 15A · 25A · 50A	H-IN-3	H-OU-9
RMB15A · 30A · 50A		H-OU-16
RMC15A · 30A · 50A		H-OU-15

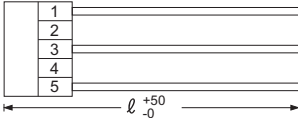
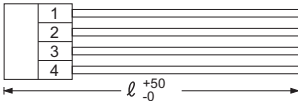
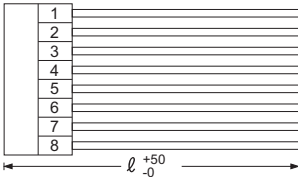
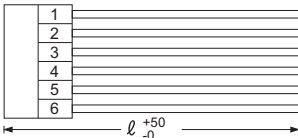
<p>●Model number H-IN-3</p> <p>Housing : VHR-5N (J.S.T.) Pin : SVH-21T-P1.1 (J.S.T.) Weight : 20g max</p>	<p>●Type</p> 	<p>●Wire</p> <table border="1"> <thead> <tr> <th>Pin #</th> <th>Wire</th> <th>AWG</th> <th>Color</th> <th>Length ℓ (mm)</th> </tr> </thead> <tbody> <tr> <td>1</td> <td>UL1015</td> <td>20</td> <td>white</td> <td>500</td> </tr> <tr> <td>2</td> <td></td> <td></td> <td></td> <td></td> </tr> <tr> <td>3</td> <td>UL1015</td> <td>20</td> <td>black</td> <td>500</td> </tr> <tr> <td>4</td> <td></td> <td></td> <td></td> <td></td> </tr> <tr> <td>5</td> <td>UL1015</td> <td>20</td> <td>green</td> <td>500</td> </tr> </tbody> </table>	Pin #	Wire	AWG	Color	Length ℓ (mm)	1	UL1015	20	white	500	2					3	UL1015	20	black	500	4					5	UL1015	20	green	500															
Pin #	Wire	AWG	Color	Length ℓ (mm)																																											
1	UL1015	20	white	500																																											
2																																															
3	UL1015	20	black	500																																											
4																																															
5	UL1015	20	green	500																																											
<p>●Model number H-OU-9</p> <p>Housing : VHR-4N (J.S.T.) Pin : SVH-21T-P1.1 (J.S.T.) Weight : 40g max</p>	<p>●Type</p> 	<p>●Wire</p> <table border="1"> <thead> <tr> <th>Pin #</th> <th>Wire</th> <th>AWG</th> <th>Color</th> <th>Length ℓ (mm)</th> </tr> </thead> <tbody> <tr> <td>1</td> <td>UL1015</td> <td>18</td> <td>black</td> <td>500</td> </tr> <tr> <td>2</td> <td>UL1015</td> <td>18</td> <td>black</td> <td>500</td> </tr> <tr> <td>3</td> <td>UL1015</td> <td>18</td> <td>red</td> <td>500</td> </tr> <tr> <td>4</td> <td>UL1015</td> <td>18</td> <td>red</td> <td>500</td> </tr> </tbody> </table>	Pin #	Wire	AWG	Color	Length ℓ (mm)	1	UL1015	18	black	500	2	UL1015	18	black	500	3	UL1015	18	red	500	4	UL1015	18	red	500																				
Pin #	Wire	AWG	Color	Length ℓ (mm)																																											
1	UL1015	18	black	500																																											
2	UL1015	18	black	500																																											
3	UL1015	18	red	500																																											
4	UL1015	18	red	500																																											
<p>●Model number H-OU-15</p> <p>Housing : VHR-8N (J.S.T.) Pin : SVH-21T-P1.1 (J.S.T.) Weight : 80g max</p>	<p>●Type</p> 	<p>●Wire</p> <table border="1"> <thead> <tr> <th>Pin #</th> <th>Wire</th> <th>AWG</th> <th>Color</th> <th>Length ℓ (mm)</th> </tr> </thead> <tbody> <tr> <td>1</td> <td>UL1015</td> <td>18</td> <td>purple</td> <td>500</td> </tr> <tr> <td>2</td> <td>UL1015</td> <td>18</td> <td>gray</td> <td>500</td> </tr> <tr> <td>3</td> <td>UL1015</td> <td>18</td> <td>gray</td> <td>500</td> </tr> <tr> <td>4</td> <td>UL1015</td> <td>18</td> <td>orange</td> <td>500</td> </tr> <tr> <td>5</td> <td>UL1015</td> <td>18</td> <td>black</td> <td>500</td> </tr> <tr> <td>6</td> <td>UL1015</td> <td>18</td> <td>black</td> <td>500</td> </tr> <tr> <td>7</td> <td>UL1015</td> <td>18</td> <td>red</td> <td>500</td> </tr> <tr> <td>8</td> <td>UL1015</td> <td>18</td> <td>red</td> <td>500</td> </tr> </tbody> </table>	Pin #	Wire	AWG	Color	Length ℓ (mm)	1	UL1015	18	purple	500	2	UL1015	18	gray	500	3	UL1015	18	gray	500	4	UL1015	18	orange	500	5	UL1015	18	black	500	6	UL1015	18	black	500	7	UL1015	18	red	500	8	UL1015	18	red	500
Pin #	Wire	AWG	Color	Length ℓ (mm)																																											
1	UL1015	18	purple	500																																											
2	UL1015	18	gray	500																																											
3	UL1015	18	gray	500																																											
4	UL1015	18	orange	500																																											
5	UL1015	18	black	500																																											
6	UL1015	18	black	500																																											
7	UL1015	18	red	500																																											
8	UL1015	18	red	500																																											
<p>●Model number H-OU-16</p> <p>Housing : VHR-6N (J.S.T.) Pin : SVH-21T-P1.1 (J.S.T.) Weight : 60g max</p>	<p>●Type</p> 	<p>●Wire</p> <table border="1"> <thead> <tr> <th>Pin #</th> <th>Wire</th> <th>AWG</th> <th>Color</th> <th>Length ℓ (mm)</th> </tr> </thead> <tbody> <tr> <td>1</td> <td>UL1015</td> <td>18</td> <td>gray</td> <td>500</td> </tr> <tr> <td>2</td> <td>UL1015</td> <td>18</td> <td>orange</td> <td>500</td> </tr> <tr> <td>3</td> <td>UL1015</td> <td>18</td> <td>black</td> <td>500</td> </tr> <tr> <td>4</td> <td>UL1015</td> <td>18</td> <td>black</td> <td>500</td> </tr> <tr> <td>5</td> <td>UL1015</td> <td>18</td> <td>red</td> <td>500</td> </tr> <tr> <td>6</td> <td>UL1015</td> <td>18</td> <td>red</td> <td>500</td> </tr> </tbody> </table>	Pin #	Wire	AWG	Color	Length ℓ (mm)	1	UL1015	18	gray	500	2	UL1015	18	orange	500	3	UL1015	18	black	500	4	UL1015	18	black	500	5	UL1015	18	red	500	6	UL1015	18	red	500										
Pin #	Wire	AWG	Color	Length ℓ (mm)																																											
1	UL1015	18	gray	500																																											
2	UL1015	18	orange	500																																											
3	UL1015	18	black	500																																											
4	UL1015	18	black	500																																											
5	UL1015	18	red	500																																											
6	UL1015	18	red	500																																											

Mouser Electronics

Authorized Distributor

Click to View Pricing, Inventory, Delivery & Lifecycle Information:

Cosel:

[F-R25-2](#) [F-R10-1](#) [F-R50-2](#) [H-OU-16](#) [F-R150-1](#) [F-R15-2](#) [H-OU-9](#) [F-R15-1](#) [H-OU-15](#) [F-R100-2](#) [F-R150-2](#) [F-R100-1](#) [F-R25-1](#) [F-R50-1](#) [H-IN-3](#)

Данный компонент на территории Российской Федерации

Вы можете приобрести в компании MosChip.

Для оперативного оформления запроса Вам необходимо перейти по данной ссылке:

<http://moschip.ru/get-element>

Вы можете разместить у нас заказ для любого Вашего проекта, будь то серийное производство или разработка единичного прибора.

В нашем ассортименте представлены ведущие мировые производители активных и пассивных электронных компонентов.

Нашей специализацией является поставка электронной компонентной базы двойного назначения, продукции таких производителей как XILINX, Intel (ex.ALTERA), Vicor, Microchip, Texas Instruments, Analog Devices, Mini-Circuits, Amphenol, Glenair.

Сотрудничество с глобальными дистрибьюторами электронных компонентов, предоставляет возможность заказывать и получать с международных складов практически любой перечень компонентов в оптимальные для Вас сроки.

На всех этапах разработки и производства наши партнеры могут получить квалифицированную поддержку опытных инженеров.

Система менеджмента качества компании отвечает требованиям в соответствии с ГОСТ Р ИСО 9001, ГОСТ РВ 0015-002 и ЭС РД 009

Офис по работе с юридическими лицами:

105318, г.Москва, ул.Щербаковская д.3, офис 1107, 1118, ДЦ «Щербаковский»

Телефон: +7 495 668-12-70 (многоканальный)

Факс: +7 495 668-12-70 (доб.304)

E-mail: info@moschip.ru

Skype отдела продаж:

moschip.ru

moschip.ru_4

moschip.ru_6

moschip.ru_9